



**THE LODGE AT MOUNTAIN VILLAGE  
 A CONDOMINIUM  
 PHASE FOUR**

LOT 1006-R, TOWN OF MOUNTAIN VILLAGE, SAN MIGUEL COUNTY, COLORADO  
 BUILDING FOUR - BUILDING LOCATION AND UNIT AREA SUMMARY

BUILDING FOUR					
UNIT #	UNIT TYPE	UNIT	LOFT	D/P	STORAGE
101	LODGE EFF.	525	0	61	0
103	LOCK-OFF	231	0	0	0
105	LODGE EFF.	860	0	135	0
107	LOCK-OFF	250	0	0	0
109	LODGE EFF.	860	0	135	0
111	LOCK-OFF	231	0	0	0
113	LODGE EFF.	860	0	135	0
115	LOCK-OFF	250	0	0	0
117	LODGE EFF.	860	0	135	0
119	LOCK-OFF	231	0	0	0
121	LODGE EFF.	860	0	135	0
123	LOCK-OFF	250	0	0	0
125	LODGE EFF.	860	0	135	0
127	LOCK-OFF	231	0	0	0
129	LODGE EFF.	860	0	135	0
131	LOCK-OFF	250	0	0	0
133	LODGE EFF.	860	0	135	0
135	LOCK-OFF	231	0	0	0
137	LODGE EFF.	860	0	135	0
139	LOCK-OFF	250	0	0	0
141	LODGE EFF.	860	0	135	0
143	LOCK-OFF	231	0	0	0
145	LODGE EFF.	860	0	135	0
147	LOCK-OFF	250	0	0	0
149	LODGE EFF.	860	0	135	0
151	LOCK-OFF	231	0	0	0
153	LODGE EFF.	860	0	135	0
155	LOCK-OFF	250	0	0	0
157	LODGE EFF.	860	0	135	0
159	LOCK-OFF	231	0	0	0
161	LODGE EFF.	860	0	135	0
163	LOCK-OFF	250	0	0	0
165	LODGE EFF.	860	0	135	0
167	LOCK-OFF	231	0	0	0
169	LODGE EFF.	860	0	135	0
171	LOCK-OFF	250	0	0	0
173	LODGE EFF.	860	0	135	0
175	LOCK-OFF	231	0	0	0
177	LODGE EFF.	860	0	135	0
179	LOCK-OFF	250	0	0	0
181	LODGE EFF.	860	0	135	0
183	LOCK-OFF	231	0	0	0
185	LODGE EFF.	860	0	135	0
187	LOCK-OFF	250	0	0	0
189	LODGE EFF.	860	0	135	0
191	LOCK-OFF	231	0	0	0
193	LODGE EFF.	860	0	135	0
195	LOCK-OFF	250	0	0	0
197	LODGE EFF.	860	0	135	0
199	LOCK-OFF	231	0	0	0
201	LODGE EFF.	860	0	135	0
203	LOCK-OFF	250	0	0	0
205	LODGE EFF.	860	0	135	0
207	LOCK-OFF	231	0	0	0
209	LODGE EFF.	860	0	135	0
211	LOCK-OFF	250	0	0	0
213	LODGE EFF.	860	0	135	0
215	LOCK-OFF	231	0	0	0
217	LODGE EFF.	860	0	135	0
219	LOCK-OFF	250	0	0	0
221	LODGE EFF.	860	0	135	0
223	LOCK-OFF	231	0	0	0
225	LODGE EFF.	860	0	135	0
227	LOCK-OFF	250	0	0	0
229	LODGE EFF.	860	0	135	0
231	LOCK-OFF	231	0	0	0
233	LODGE EFF.	860	0	135	0
235	LOCK-OFF	250	0	0	0
237	LODGE EFF.	860	0	135	0
239	LOCK-OFF	231	0	0	0
241	LODGE EFF.	860	0	135	0
243	LOCK-OFF	250	0	0	0
245	LODGE EFF.	860	0	135	0
247	LOCK-OFF	231	0	0	0
249	LODGE EFF.	860	0	135	0
251	LOCK-OFF	250	0	0	0
253	LODGE EFF.	860	0	135	0
255	LOCK-OFF	231	0	0	0
257	LODGE EFF.	860	0	135	0
259	LOCK-OFF	250	0	0	0
261	LODGE EFF.	860	0	135	0
263	LOCK-OFF	231	0	0	0
265	LODGE EFF.	860	0	135	0
267	LOCK-OFF	250	0	0	0
269	LODGE EFF.	860	0	135	0
271	LOCK-OFF	231	0	0	0
273	LODGE EFF.	860	0	135	0
275	LOCK-OFF	250	0	0	0
277	LODGE EFF.	860	0	135	0
279	LOCK-OFF	231	0	0	0
281	LODGE EFF.	860	0	135	0
283	LOCK-OFF	250	0	0	0
285	LODGE EFF.	860	0	135	0
287	LOCK-OFF	231	0	0	0
289	LODGE EFF.	860	0	135	0
291	LOCK-OFF	250	0	0	0
293	LODGE EFF.	860	0	135	0
295	LOCK-OFF	231	0	0	0
297	LODGE EFF.	860	0	135	0
299	LOCK-OFF	250	0	0	0
301	LODGE EFF. W/LOFT	503	229	28	0
303	LOCK-OFF	254	0	0	0
305	LODGE W/LOFT	560	244	48	12
307	LOCK-OFF	250	0	0	0
309	LODGE W/LOFT	560	244	48	12
311	LOCK-OFF	250	0	0	0
313	LODGE W/LOFT	560	244	48	12
315	LOCK-OFF	250	0	0	0
317	LODGE W/LOFT	560	244	48	12
319	LOCK-OFF	250	0	0	0
321	LODGE W/LOFT	560	244	48	12
323	LOCK-OFF	250	0	0	0
325	LODGE W/LOFT	560	244	48	12
327	LOCK-OFF	250	0	0	0
329	LODGE W/LOFT	560	244	48	12
331	LOCK-OFF	250	0	0	0
333	LODGE W/LOFT	560	244	48	12
335	LOCK-OFF	250	0	0	0
337	LODGE W/LOFT	560	244	48	12
339	LOCK-OFF	250	0	0	0
341	LODGE W/LOFT	560	244	48	12
343	LOCK-OFF	250	0	0	0
345	LODGE W/LOFT	560	244	48	12
347	LOCK-OFF	250	0	0	0
349	LODGE W/LOFT	560	244	48	12
351	LOCK-OFF	250	0	0	0
353	LODGE W/LOFT	560	244	48	12
355	LOCK-OFF	250	0	0	0
357	LODGE W/LOFT	560	244	48	12
359	LOCK-OFF	250	0	0	0
361	LODGE W/LOFT	560	244	48	12
363	LOCK-OFF	250	0	0	0
365	LODGE W/LOFT	560	244	48	12
367	LOCK-OFF	250	0	0	0
369	LODGE W/LOFT	560	244	48	12
371	LOCK-OFF	250	0	0	0
373	LODGE W/LOFT	560	244	48	12
375	LOCK-OFF	250	0	0	0
377	LODGE W/LOFT	560	244	48	12
379	LOCK-OFF	250	0	0	0
381	LODGE W/LOFT	560	244	48	12
383	LOCK-OFF	250	0	0	0
385	LODGE W/LOFT	560	244	48	12
387	LOCK-OFF	250	0	0	0
389	LODGE W/LOFT	560	244	48	12
391	LOCK-OFF	250	0	0	0
393	LODGE W/LOFT	560	244	48	12
395	LOCK-OFF	250	0	0	0
397	LODGE W/LOFT	560	244	48	12
399	LOCK-OFF	250	0	0	0
401	LODGE W/LOFT	560	244	48	12
403	LOCK-OFF	250	0	0	0
405	LODGE W/LOFT	560	244	48	12
407	LOCK-OFF	250	0	0	0
409	LODGE W/LOFT	560	244	48	12
411	LOCK-OFF	250	0	0	0
413	LODGE W/LOFT	560	244	48	12
415	LOCK-OFF	250	0	0	0
417	LODGE W/LOFT	560	244	48	12
419	LOCK-OFF	250	0	0	0
421	LODGE W/LOFT	560	244	48	12
423	LOCK-OFF	250	0	0	0
425	LODGE W/LOFT	560	244	48	12
427	LOCK-OFF	250	0	0	0
429	LODGE W/LOFT	560	244	48	12
431	LOCK-OFF	250	0	0	0
433	LODGE W/LOFT	560	244	48	12
435	LOCK-OFF	250	0	0	0
437	LODGE W/LOFT	560	244	48	12
439	LOCK-OFF	250	0	0	0
441	LODGE W/LOFT	560	244	48	12
443	LOCK-OFF	250	0	0	0
445	LODGE W/LOFT	560	244	48	12
447	LOCK-OFF	250	0	0	0
449	LODGE W/LOFT	560	244	48	12
451	LOCK-OFF	250	0	0	0
453	LODGE W/LOFT	560	244	48	12
455	LOCK-OFF	250	0	0	0
457	LODGE W/LOFT	560	244	48	12
459	LOCK-OFF	250	0	0	0
461	LODGE W/LOFT	560	244	48	12
463	LOCK-OFF	250	0	0	0
465	LODGE W/LOFT	560	244	48	12
467	LOCK-OFF	250	0	0	0
469	LODGE W/LOFT	560	244	48	12
471	LOCK-OFF	250	0	0	0
473	LODGE W/LOFT	560	244	48	12
475	LOCK-OFF	250	0	0	0
477	LODGE W/LOFT	560	244	48	12
479	LOCK-OFF	250	0	0	0
481	LODGE W/LOFT	560	244	48	12
483	LOCK-OFF	250	0	0	0
485	LODGE W/LOFT	560	244	48	12
487	LOCK-OFF	250	0	0	0
489	LODGE W/LOFT	560	244	48	12
491	LOCK-OFF	250	0	0	0
493	LODGE W/LOFT	560	244	48	12
495	LOCK-OFF	250	0	0	0
497	LODGE W/LOFT	560	244	48	12
499	LOCK-OFF	250	0	0	0
501	LODGE W/LOFT	503	229	28	0
503	LOCK-OFF	254	0	0	0
505	LODGE W/LOFT	560	244	48	12
507	LOCK-OFF	250	0	0	0
509	LODGE W/LOFT	560	244	48	12
511	LOCK-OFF	250	0	0	0
513	LODGE W/LOFT	560	244	48	12
515	LOCK-OFF	250	0	0	0
517	LODGE W/LOFT	560	244	48	12
519	LOCK-OFF	250	0	0	0
521	LODGE W/LOFT	560	244	48	12
523	LOCK-OFF	250	0	0	0
525	LODGE W/LOFT	560	244	48	12
527	LOCK-OFF	250	0	0	0
529	LODGE W/LOFT	560	244	48	12
531	LOCK-OFF	250	0	0	0
533	LODGE W/LOFT	560	244	48	12
535	LOCK-OFF	250	0	0	0
537	LODGE W/LOFT	560	244	48	12
539	LOCK-OFF	250	0	0	0
541	LODGE W/LOFT	560	244	48	12
543	LOCK-OFF	250	0	0	0
545	LODGE W/LOFT	560	244	48	12
547	LOCK-OFF	250	0	0	0
549	LODGE W/LOFT	560	244	48	12
551	LOCK-OFF	250	0	0	0
553	LODGE W/LOFT	560	244	48	12
555	LOCK-OFF	250	0	0	0
557	LODGE W/LOFT	560	244	48	12
559	LOCK-OFF	250	0	0	0
561	LODGE W/LOFT	560	244	48	12
563	LOCK-OFF	250	0	0	0
565	LODGE W/LOFT	560	244	48	12
567	LOCK-OFF	250	0	0	0
569	LODGE W/LOFT	560	244	48	12
571	LOCK-OFF	250	0	0	0
573	LODGE W/LOFT	560	244	48	12
575	LOCK-OFF	250	0	0	0
577	LODGE W/LOFT	560	244	48	12
579	LOCK-OFF	250	0	0	0
581	LODGE W/LOFT	560	244	48	12

# THE LODGE AT MOUNTAIN VILLAGE A CONDOMINIUM PHASE FOUR

LOT 1006-R, TOWN OF MOUNTAIN VILLAGE,  
SAN MIGUEL COUNTY, COLORADO

BUILDING FOUR - FLOORS ONE AND TWO

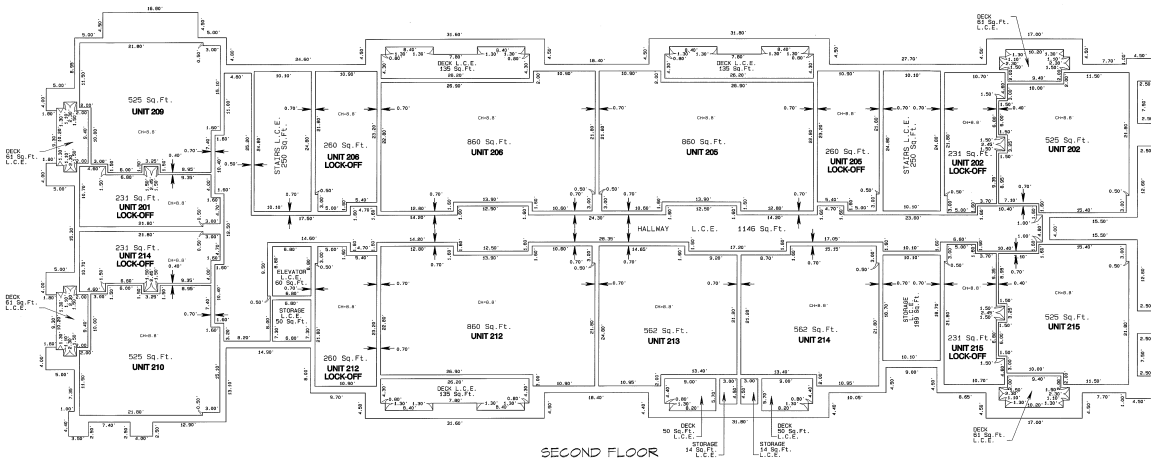

SECOND FLOOR

NOTES:  
 ACCORDING TO COLORADO LAW YOU MUST COMMENCE ANY LEGAL ACTION BASED UPON ANY DEFECTS IN THIS SURVEY WITHIN THREE YEARS AFTER YOU FIRST DISCOVER SUCH DEFECT. IN NO EVENT MAY ANY ACTION BASED UPON ANY DEFECTS IN THIS SURVEY BE COMMENCED MORE THAN TEN YEARS FROM THE DATE OF CERTIFICATION SHOWN HEREON.

C.F. - INDICATES CEILING HEIGHT  
 C.E. - INDICATES COMMON ELEMENT  
 L.C.E. - INDICATES LIMITED COMMON ELEMENT  
 SEE SHEET 1 FOR ADDITIONAL NOTES, OWNERS CERTIFICATE AND SURVEYORS CERTIFICATE  
 SEE SHEET 2 FOR SITE PLAN AND UNIT AREA SUMMARY CHART  
 SEE SHEETS 3 AND 4 FOR BUILDING DETAILS  
 SEE SHEET 5 FOR BUILDING ELEVATION DETAILS

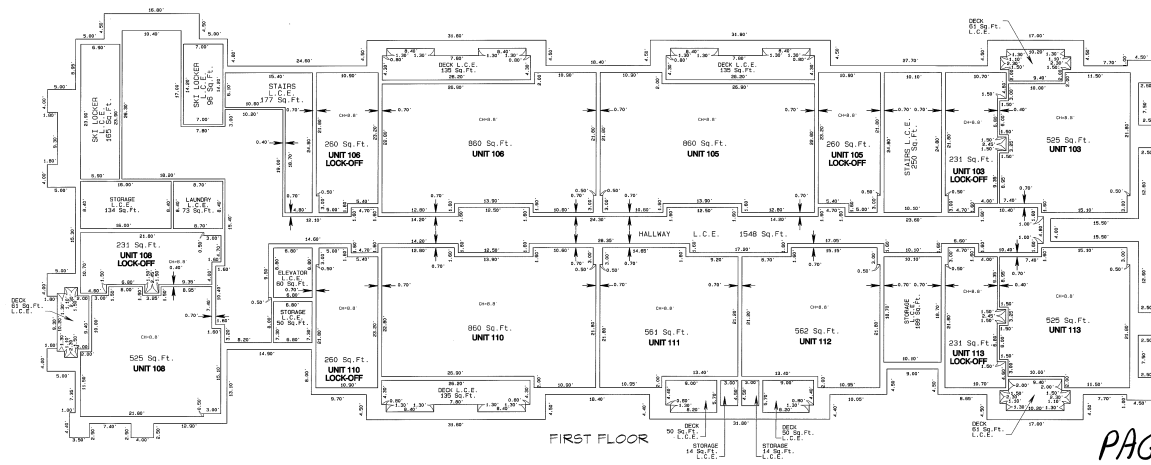

FIRST FLOOR

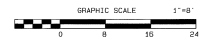

PREPARED BY:  
 ROCKY MOUNTAIN LAND SURVEYING INC.  
 818 ADAMS RANCH RD. SUITE 2A  
 P.O. BOX 2838 TELLURIDE, COLORADO 81456  
 (970) 728-8106 (970) 728-0258 Fax  
 JANUARY 18, 2000  
 SHEET 3 OF 5 SHEETS

PAGE 2685

# THE LODGE AT MOUNTAIN VILLAGE A CONDOMINIUM PHASE FOUR

LOT 1006-F, TOWN OF MOUNTAIN VILLAGE,  
SAN MIGUEL COUNTY, COLORADO

BUILDING FOUR - FLOOR THREE AND LOFTS

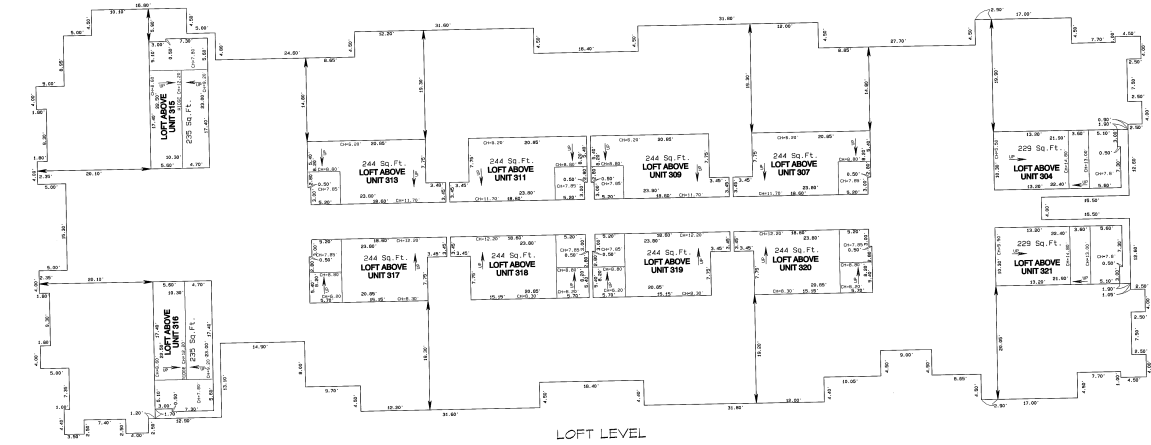

LOFT LEVEL

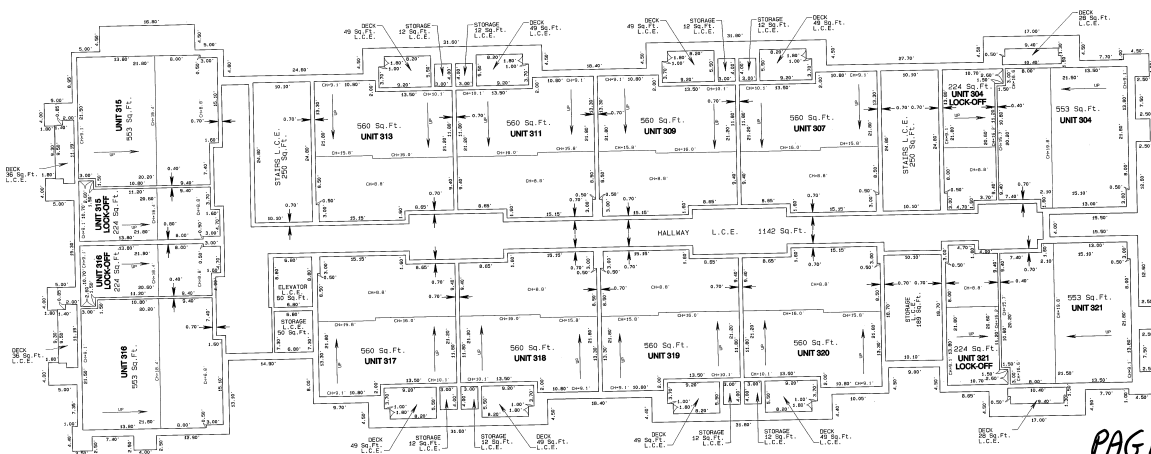

THIRD FLOOR

NOTES:  
 ACCORDING TO COLORADO L.M. YOU MUST COMMENCE ANY LEGAL ACTION BASED UPON ANY DEFECT IN THIS SURVEY WITHIN THREE YEARS AFTER YOU FIRST DISCOVER SUCH DEFECT. IN NO EVENT SHALL ANY ACTION BASED UPON ANY DEFECT IN THIS SURVEY BE COMMENCED MORE THAN TEN YEARS FROM THE DATE OF CERTIFICATION SHOWN BELOW.

C.H. - INDICATES CEILING HEIGHT  
 C.E. - INDICATES COMMON ELEMENT  
 L.C.E. - INDICATES LIMITED COMMON ELEMENT

SEE SHEET 3 FOR ADDITIONAL NOTES, OWNERS CERTIFICATE AND SURVEYORS CERTIFICATE.  
 SEE SHEET 3 FOR TITLE PLAN AND UNIT AREA QUANTITY CHART  
 SEE SHEETS 3 AND 4 FOR BUILDING 4 DETAILS  
 SEE SHEET 5 FOR BUILDING 4 ELEVATION DETAILS

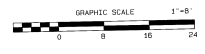

PREPARED BY:  
 ROCKY MOUNTAIN LAND SURVEYING, INC.  
 315 ADAMS RANCH RD., SUITE 204  
 P.O. BOX 2354 TELLURIDE, COLORADO 81435  
 (PH) 726-9186 (FAX) 726-9185

JANUARY 19, 2000  
 SHEET 4 OF 5 SHEETS

PAGE 2686

# THE LODGE AT MOUNTAIN VILLAGE A CONDOMINIUM PHASE FOUR

LOT 1006-R, TOWN OF MOUNTAIN VILLAGE,  
SAN MIGUEL COUNTY, COLORADO

BUILDING FOUR - ELEVATION DETAILS



BUILDING FOUR - SOUTHWESTERLY ELEVATION VIEW

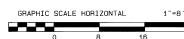

NOTES:  
 ACCORDING TO COLORADO LAW YOU MUST COMMENCE ANY LEGAL ACTION  
 BASED UPON ANY DEFECT IN THIS SURVEY WITHIN THREE YEARS AFTER  
 YOU FIRST DISCOVER SUCH DEFECT. IN NO EVENT MAY ANY ACTION BASED  
 UPON ANY DEFECT IN THIS SURVEY BE COMMENCED MORE THAN TEN YEARS  
 FROM THE DATE OF CERTIFICATION SHOWN HEREON.

C.H. = INDICATES CEILING HEIGHT  
 C.E. = INDICATES COMMON ELEMENT  
 L.C.E. = INDICATES LIMITED COMMON ELEMENT

SEE SHEET 1 FOR ADDITIONAL NOTES, OWNERS CERTIFICATE  
 AND SURVEYORS CERTIFICATE.  
 SEE SHEET 2 FOR SITE PLAN AND UNIT AREA SUMMARY CHART  
 SEE SHEETS 3 AND 4 FOR BUILDING 4 DETAILS  
 SEE SHEET 5 FOR BUILDING 4 ELEVATION DETAILS

PREPARED BY:  
 ROCKY MOUNTAIN LAND SURVEYING, INC.  
 838 ADAMS RANCH RD., SUITE 2A  
 P.O. BOX 2039 TELLURIDE, COLORADO 81426  
 (970) 726-8186 (970) 726-0225 Fax

JANUARY 15, 2000  
 SHEET 5 OF 5 SHEETS

PAGE 2687