



AGENDA ITEM 9
PLANNING & DEVELOPMENT SERVICE
PLANNING DIVISION
455 Mountain Village Blvd.
Mountain Village, CO 81435
(970) 728-1392

TO: Mountain Village Design Review Board
FROM: John Miller, Senior Planner
FOR: Design Review Board Public Hearing; March 4, 2021
DATE: February 22, 2021
RE: Staff Memo – Initial Architecture and Site Review (IASR) Lot 161D-1 Unit 19

APPLICATION OVERVIEW:

PROJECT GEOGRAPHY

Legal Description: UNIT 19 THE RIDGE AT TELLURIDE A PLANNED COMMUNITY LOT 161A4 ACC TO PLAT REC 04 05 2004 BK 1 PG 3262 3265 AND ACC TO 6TH SUPPLEMENTAL AND AMENDED PLANNED COMMUNITY PLAT PHASES 1 THRU 7 REC 07 02 2010 PLAT BK 1 PG 4349 4353 AND 6TH SUPPLEMENT & AMENDMENT TO DECS AT 413135 A 5.55 PER INT IN UNIT 4 LOT 161A 1R BLDG LOT 161 D1 OPEN SPACE TRACTS ROS 1A 2C 4B 5A 6A 7A LOT 161A 4 OPEN SPACE TRACTS ROS 1B 2B 3A 4A AND LOT 161A R3 OPEN SPACE TRACT ROS 5B COMMON ELEMENTS

Address: 1 La Sal Lane
Applicant/Agent: Steve Morton, Morton Architects
Owner: Tommy and Sloan Lusk
Zoning: Multi-Family
Existing Use: Vacant Lot
Proposed Use: Detached Condominium
Lot Size: 7,500 square feet

Adjacent Land Uses:

- **North:** Multi-Family
- **South:** Multi-Family
- **East:** Multi-Family
- **West:** Multi-Family

ATTACHMENTS

Exhibit A: Architectural Plan Set
Exhibit B: Staff/Referral Comments



Figure 1: Vicinity Map

Case Summary: Steve Morton of Morton Architects (Applicant), on the behalf of Tommy and Sloan Lusk (Owner) is requesting Design Review Board (DRB) approval of an Initial Architectural and Site Review (IASR) Application for a new single-family detached condominium located at Lot 161D-1, Unit 19, 1 La Sal Lane. The Lot is 7,500 square feet and is zoned Multi-Family. The proposal includes a detached condo with an approximate gross square footage of 7,281 square feet. Because of the home's location near the top of Coonskin Ridge, additional development regulations must be addressed in addition to the general Design Review Standards – specifically, CDC Section 17.5.16: Ridgeline Lots. The applicant has provided all the required materials for the IASR for the proposed home. It should be noted that in 2008, Unit 19 was approved for the development of a similarly designed detached condominium that began construction but was never finalized. There is currently an existing foundation that was abandoned as part of that project which has been incorporated into this new design.

County and Town Settlement Agreement

In 1999 the Town and County entered into a settlement agreement that addressed a number of county issues including and not limited to the operations of the gondola, the Ridgeline Covenant, the final Mountain Village development plan, wetland regulations, and deed-restricted housing.. Pursuant to the settlement agreement, the Town of Mountain Village sends development application referrals to San Miguel County and the Town of Telluride when a development is proposed subject to the Ridgeline Covenant.. for comment. . What is within the DRB's purview are the provisions outlined in the CDC and the enhanced design requirements found under the Ridgeline Lots section of the CDC and outlined below. The Town does not enforce the provisions of the Settlement Agreement although we adhere to the courtesy notice provisions as outlined in the settlement agreement and any additional requirement as outlined in the CDC.

Story Pole Requirement

Due to the location of the home the application is required to erect story poles however, the provision can be requested to be waived. The applicant has requested the Community Development Director waive the story pole requirement. This request is at the Director's discretion per the CDC. This request is also consistent with the Lot 161D-1, Unit 15, and Unit 17 waiver approval which was previously granted. This provision was waived. As a courtesy, the county and Town of Telluride agreed to waiving the story pole requirement.

Applicable CDC Requirement Analysis: The applicable requirements cited may not be exhaustive or all-inclusive. The applicant is required to follow all requirements even if an applicable section of the CDC is not cited. ***Please note that Staff comments will be indicated by italicized Text.***

Table 1

<u>CDC Provision</u>	<u>Requirement</u>	<u>Proposed</u>
Maximum Building Height	45' (ridge allowance)	40'-6"
Maximum Average Height	30' (ridge allowance)	25'- 5/8"
Maximum Lot Coverage	Not applicable to Ridge	
General Easement Setbacks	No GE	
Roof Pitch		
Primary		12:12
Secondary		6:12, 4:12
Exterior Material		
Stone	35% minimum	40%
Windows/Doors	40% maximum	27%
Parking	1	1

Chapter 17.3: ZONING AND LAND USE REGULATIONS

17.3.12: Building Height Limits

Sections 17.3.11 and 17.3.12 of the CDC provide the methods for measuring Building Height and Average Building Height, along with providing the height allowances for specific types of buildings based on their architectural form. The proposed design incorporates gabled roof forms with minor secondary shed roof forms. Because of development agreements memorialized in the CDC, the Unit 19 is classified as a ridge lot, and with that, it is granted a different height allowance than other detached condominiums in the Mountain Village. The unit is subject in this case to a 45-foot height limit from the finished grade.

Staff: The Maximum Building Height and Average Building Height analysis has been provided on pages A3 and A3.1 of the submitted plan set and shown above in Table 1. With a Maximum Height of 40'-6" and a Max Average Height of approximately 25'-0", any future approval should condition that a height survey is required prior to the issuance of a framing inspection to determine the heights comply with any DRB approved plan and the development agreement for Coonskin Ridge.

17.3.14: General Easement Setbacks

Lot 161D-1, Unit 19 is not burdened by any General Easements or Setbacks. The development documents specify that each unit on Lot 161D-1 is permitted to utilize the full 7,500 square feet allocated.

Chapter 17.5: DESIGN REGULATIONS

17.5.4: Town Design Theme

The Town of Mountain Village has established design themes aimed at creating a strong image and sense of place for the community. Due to the fragile high alpine environment, architecture and landscaping shall be respectful and responsive to the tradition of alpine design – reflecting elements of alpine regions while blending influences that visually tie the town to mountain buildings. The town recognizes that architecture will continue to evolve and create a regionally unique mountain vernacular, but these evolutions must continue to embrace nature and traditional style in a way that respects the design context of the neighborhoods surrounding the site.

Staff: Unit 19 has incorporated the traditional design elements referenced in the CDC such as a strong grounded base, as well as metal, timber, and wood elements. Combined, the submittal blends well with the surrounding community and homes located at the ridge. The materials are discussed below in more detail as it relates to the ridgeline lot requirements of Section 17.5.16

The massing and form of the proposed home at Unit 19 is very traditional as it relates to recent home designs in the Mountain Village. The gabled roof form appears to be augmented nicely through the smaller secondary shed roofs. The home is sized at approximately 7,281 gross square feet, which is in line with other home sizes along the ridge. Due to the slope of the site, the design of the home does well at minimizing the mass of the home by incorporating areas of the home into the hillside.

17.5.5: Building Siting Design

The CDC requires that any proposed development blend into the existing landforms and vegetation.

Staff: As briefly mentioned above, these lots essentially function as footprint lots and allow for the full development of the allocated 7,500 square feet. With that, the location of the

home's building envelope is tied to the subdivision documents and the location of the specific units within Lot 161D-1. It does appear that the home has attempted some visual subordination by incorporating the design of the home into the hillside. This appears to result in a less proud home as seen from the Mountain Village. Additionally, there are mature trees throughout Lot 161D-1 that help to visually shield the home. Due to the steep slopes, vegetation, and location – it will be difficult to blend all future development of the homesites into the existing landforms entirely. With that being said, staff believes this project to be accomplishing this standard.

17.5.6: Building Design

Staff: The CDC requires that building form and exterior wall forms portray a mass that is thick and strong with a heavy grounded foundation. Although the applicant is meeting the material requirements for stone and fenestration, the east elevation does have areas of wood that extend to the ground (identified below). Staff believes that it's important to increase stone amounts in this area because the elevation of the site and the associated snow depths could create issues with the longevity of the wood if not protected from snow and water.

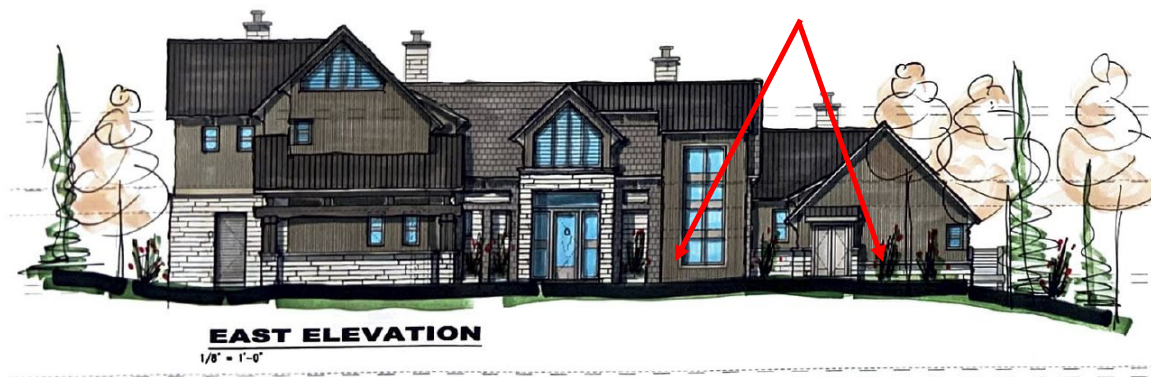

The home's exterior palette contrasts and blends well between the lighter stone, the bonderized metal shingles, the vertical wood elements, and the darker grey-black elements of the roof and windows. An interesting feature is the bonderized metal shingles which appear to be used for certain areas of the roof but are also utilized as a siding material. It's unclear to staff at this time what materials will be used for the garage door. The CDC allows for black metal standing seam and bonderized roofing materials and this appears to meet that requirement. Staff questions the shed roof port-cochere seen best on the south elevation as it relates to the grade and retaining walls. This area will during a deep snow event be completely covered with snow from the roof to the adjacent ground. This could create a tunnel effect and portions of the home may be buried.



The applicant has not indicated areas of snowmelt, but the CDC allows for 1000 square feet of snowmelt without penalty. Staff recommends identifying and including those areas in a final design review application.

17.5.7: Grading and Drainage Design

Staff: The applicant has provided a conceptual grading and drainage plan as it relates to access, and grading required for areas surrounding the home. Because of the grade of the site, the applicant is proposing access to the site across the Common Element Open Space Tract, which will require grading and retaining walls. The majority of the grade changes are on the downhill side of the home. Prior to the final review, the applicants will revise their grading and drainage plan to include final finished slopes.

17.5.8: Parking Regulations

Pursuant to Resolution No. 2003-0610-10 and the Lot 161CR settlement agreement the parking requirement for this property is one parking space to be satisfied either by a parking reservation agreement at Lot 161CR when the parking garage is finally developed or a parking payment in lieu to the Town of Mountain Village. Unit 19 executed a Reservation and Escrow Agreement and deposited the corresponding \$60,000 deposit for a deed parking space on December 15, 2020, per the parking settlement agreement. As such, Unit 19 currently parks on the surface of Lot 161C-R and will have a deeded parking space when covered parking is completed.

The applicant has also proposed space within the garage of the home for two golf carts to be used in summer months.

17.5.9: Landscaping Regulations

The applicant has provided a preliminary landscaping plan showing the general intent of the future landscaping. Staff is requesting that prior to final review, the applicant modify this conceptual plan to include specific species and sizes within the planting schedule along with planting notes, revegetation notes, and other general requirements. Due to the home's location and visibility, staff is requesting that the DRB waive the requirements of the Fire Mitigation Section of the CDC.

17.5.11: Utilities

Staff: All utilities are currently located within proximity to the home. The applicant shall work with the Public Works Director before the final review to verify the specific locations of the connections for the home. The plan set shows the proposed connections and the locations of the proposed utilities based on field research.

17.5.12: Lighting Regulations

Staff: The applicant has provided a preliminary lighting plan at this time. Prior to final review, the applicant shall review the plan set to include a full lighting plan with locations of lamps, cut sheets, as well as a photometric study of the site. It will be important to provide very subdued lighting given the visibility of the home from the Mountain Village Core. From the conceptual plan, it appears that the applicant is proposing recessed step and can lights, as well as wall mounted lights.

17.5.13: Sign Regulations

Staff: The applicant has not provided details on the address monument/location. Prior to final review, the applicant shall provide a full address monument design to include location and method of illumination.

17.5.16: Ridgeline Lots

The CDC identifies Lot 161D-1 as a part of the Ridge Area and as such provides additional design restrictions. As previously described, the intent of these standards is to memorialize the restrictions in the development agreement. These provisions attempt to require the home to maintain visual subordination to the natural landscape along the ridge.

In order to accomplish this, the code requires the following:

1. *All improvements are subject to a ridgeline covenant with San Miguel County as recorded at reception number 329093. The Town does not enforce the ridgeline covenant, with enforcement solely administered by San Miguel County.*

Staff: The improvements appear to be aligned with the ridgeline covenant as discussed above within this memo. The Town of Mountain Village does not enforce this covenant but provided this application and all materials to both San Miguel County and the Town of Telluride in order for those agencies to provide comment on the proposed application.

2. *The building height on Lot 161A-1R shall not exceed 35 feet (35') along the ridgeline of such building.*

Staff: Not applicable. Subject unit is within Lot 161D-1.

3. *Building height on other ridge area lots shall not exceed the lesser of:
 - a. *The height of forty-five feet (45'); or*
 - b. *The maximum height allowed to the view plane limitation set forth in section 4 below.**

Staff: The applicant is meeting these criteria with the propose design. Because this lot is not within an identified view plane, it is limited by a height of 45 feet.

4. *Except for the existing building on Lot 161A-1R and gondola facilities, the development of ridgeline area lots shall be designed to ensure that no lighting or any part of any building or structure extends into the view plane as shown on the Coonskin View Plane drawing recorded at reception number 328113.*

Staff: Not applicable. Subject unit is not located within any view plane identified on the Coonskin View Plane.

5. *New development in the ridgeline area, excluding the existing building on Lot 161A-1R and gondola facilities, shall require (a) the erection of a story pole to reflect the maximum height of the proposed development where such development will extend closest to the view plane as described in section 4 above; and (b) the installation of a light to illuminate the story pole where off-site light would be visible from the highest window. The applicant for development shall provide written notice of the story pole erection to San Miguel County and the Town of Telluride.*

Staff: The Town of Mountain Village has waived this request due to the location of the site in relation to the Coonskin View Plane survey and the geographical ridge. SMC as a courtesy has agreed to this waiver request.

6. *To the extent practical, no exterior lights shall be installed on the east side of buildings. Any required exterior lighting shall be shielded, recessed, or reflected so that no lighting is oriented towards the east side of the building.*

Staff: This item has been somewhat addressed above within the Lighting Standards, it will be important for the applicant as part of a final submittal to revise the lighting on the east side of the home to ensure this standard is being met.

7. *No solid fuel burning device shall be allowed in the building on Lot 161A-1R.*

Staff: All fireplaces at the home are required to be natural gas-burning fixtures as noted below.

8. *For all new development, or substantial modifications to existing development, a courtesy referral shall be provided to San Miguel County and the Town of Telluride consistent with the Referral and Review Process outlined in the Development Review Procedures. The Town is not bound by any referral comments from either jurisdiction.*

Staff: A courtesy referral was provided to both the Town of Telluride and San Miguel County on January 18, 2021.

Chapter 17.6: SUPPLEMENTARY REGULATIONS

17.6.1: Environmental Regulations

Staff: Fire Mitigation and Forestry Management: Due to the location of the site, staff is requesting that the fire mitigation requirements be waived. This will allow for additional vegetative screening to be maintained to mitigate visual impacts from the Mountain Village Center.

Steep Slopes: The building site does contain steep slopes and these areas have been identified as part of the topographic survey. This has been discussed above but due to the nature of the Unit – the steep slopes are impractical to avoid.

17.6.6: Roads and Driveway Standards

Staff: The typical road and driveway standards do not apply to the ridge given its unique location and access. It would be helpful to better understand the grades of the driveway and motor court area prior to final review. Staff is particularly interested in understanding the grades of the driveway and motor court from the access on La Sal Lane.

17.6.8: Solid Fuel Burning Device Regulations

Staff: The applicant has indicated that the proposed home does include fireplaces but has not indicated on the plans that these are gas burning. The applicant will need to provide evidence of a solid fuel burning permit or revise the plans to note all fireplaces are natural gas devices.

Chapter 17.7: BUILDING REGULATIONS

17.7.19: Construction Mitigation

Staff: The applicant has submitted a CMP as part of this application. The importance of this plan for the future project should not be understated as there are a number of issues that are more complicated due to the site's unique location. The applicant will need to begin conversations with TSG in order to understand access to the site better. Additionally, staff has concerns related to excavation of the site and the associated spoils, material staging, stormwater mitigation, and other concerns typical of a large construction project

with limited vehicular access. As part of the application, the construction mitigation plan proposes to utilize neighboring Unit 18 in order to stage and provide parking etc. Although this was approved as part of the previous application in 2008, the owner will need to verify with the owner of Unit 18, that they grant permission for this use. It also could create potential future problems given the current development pressure and the extended construction timelines on the Ridge. Staff would want to ensure through written authorization that the owner of Unit 19 is authorized to utilize Unit 18 for a multi-year construction project.

Staff Recommendation: Staff recommends the DRB consider this request in relation to the CDC provisions listed above and particularly in Section 17.5.16: Ridgeline Lots to determine if the home is substantially complying with these provisions. If it's determined that the home does comply with these provisions, then staff recommends approval of the IASR, but if it's determined that these provisions are not being met then the item should be continued, and the applicant should revise the plans accordingly.

Staff Note: *It should be noted that reasons for approval or rejection should be stated in the findings of fact and motion.*

Proposed Motion for Approval:

If the DRB deems this application to be appropriate for approval, Staff requests said approval condition the items listed below in the suggested motion.

I move to approve the Initial Architectural and Site Review for a new single-family detached condominium located at Lot 161D-1 Unit 19, based on the evidence provided within the Staff Memo of record dated February 22, 2021, with the following conditions:

- 1) Prior to submittal for Final Architectural Review, the applicant will revise the civil engineering plan set to include driveway widths and retaining wall locations/heights as well as finished slope calculations.
- 2) Prior to submittal for a Final Architectural Review, the applicant shall provide design and location details for the address monument, to include lighting details and any civil revisions for shallow utilities associated with the monument.
- 3) Prior to the submittal for a Final Architectural Review, the applicant shall revise the lighting plan per the comments in this report.
- 4) Prior to the submittal for a Final Architectural Review, the applicant shall revise the landscaping plan per the comments in this report.
- 5) Prior to the issuance of a building permit, the applicant shall field verify all utilities and submit a revised utility plan to the public works director identifying the location of utilities and connection points.
- 6) Consistent with town building codes, Unenclosed accessory structures attached to buildings with habitable spaces and projections, such as decks, shall be constructed as either non-combustible, heavy timber or exterior grade ignition resistant materials such as those listed as WUIC (Wildland Urban Interface Code) approved products.
- 7) A monumented land survey shall be prepared by a Colorado public land surveyor to establish the maximum building height and the maximum average building height.
- 8) A monumented land survey of the footers will be provided prior to pouring concrete to determine there are no additional encroachments into the common open-space.
- 9) Prior to the Building Division conducting the required framing inspection, a four-foot (4') by eight-foot (8') materials board will be erected on site consistent with the review authority approval to show:

- a. The stone, setting pattern, and any grouting with the minimum size of four feet (4') by four feet (4');
- b. Wood that is stained in the approved color(s);
- c. Any approved metal exterior material;
- d. Roofing material(s); and
- e. Any other approved exterior materials

/jjm



DESIGN REVIEW PROCESS APPLICATION

PLANNING & DEVELOPMENT SERVICES
 455 Mountain Village Blvd. Suite A
 Mountain Village, CO 81435
 970-728-1392
 970-728-4342 Fax
 cd@mtnvillage.org

DESIGN REVIEW PROCESS APPLICATION			
APPLICANT INFORMATION			
Name: Steve Morton/Morton Architects, Inc.		E-mail Address: smorton@mortonarchitects.com	
Mailing Address: PO Box 3561		Phone: 970.708.2246	
City: Telluride	State: CO	Zip Code: 81435	
Mountain Village Business License Number: Pending			
PROPERTY INFORMATION			
Physical Address: Parcel ID 477902299028		Acreage: .15	
Zone District:	Zoning Designations:	Density Assigned to the Lot or Site:	
Legal Description: UNIT 19 THE RIDGE AT TELLURIDE A PLANNED COMMUNITY LOT 161A4 ACC TO PLAT REC 04 05 2004 BK 1 PG 3262 3265			
Existing Land Uses: detached condominium			
Proposed Land Uses: detached condominium			
OWNER INFORMATION			
Property Owner: Tommy & Sloan Lusk		E-mail Address: tlusk@duncanw.com	
Mailing Address: 6750 Poplar Ave. Suite 300		Phone: 901.336.2090	
City: Memphis	State: TN	Zip Code: 38138	
DESCRIPTION OF REQUEST			
<p>The building site is located within the Ridge Development (161D-1 parcel) near the top of the gondola. The home is designed to be a single family detached condominium home on three levels in a traditional alpine vernacular with contemporary references and details. The site was developed to the level of a concrete foundation approximately 12 years ago when construction ceased. The new owner wishes to start up construction on the project and finish the home</p>			

architect

Town of Mountain Village Sketch Design Review
Lusk Residence – Lot 19 The Ridge
12-28-20

The building site is located within the Ridge Development (161D-1 parcel) near the top of the gondola. The home is designed to be a single family detached condominium home on three levels in a traditional alpine vernacular with contemporary references and details. The site was developed to the level of a concrete foundation approximately 12 years ago when construction ceased. The new owner wishes to start up construction on the project and finish the home. The site is accessible via snow melted electric cart paths only, or via the ski slopes. The current proposal utilizes the existing footprint of the concrete foundation and represents an update to the character and mass and scale from the original approved design. The home is designed to blend with the surrounding ski area and other homes and respects the natural topography and landscape. The home will have steep sloping roof lines often seen in alpine architecture. It will be built with materials proven to last in a high alpine environment. The primary building forms have been designed to have strong architectural lines and heed the building height restrictions and all of the design regulations.

Drawing index

A-C	Cover sheet
**	Surveyors Site Plat
**	Topography and tree survey
A-0	Site Topography/existing condition
A1.0	Site plan
A1.0a	Site plan overall
A1.1	Site Utility Plan
A1.2	Site Construction staging plan
A1.2b	Site Construction staging access road plan
A1.3	Site Landscape plan
A1.4	Site Irrigations plan
A1.5	Site lighting plan
A2.0	Lower level floor plan
A2.1	Main level floor plan
A2.2	Upper level floor plan
A2.4	Roof plan
A3.0	Exterior elevations
A3.1	Exterior elevations
**	Exterior elevations colored
A3.M	Ext. material calculations

Town of Mountain Village Planning and Development Services Review

CHECK LIST

To be submitted prior to any meeting for which consideration of any application is to be scheduled.

General

The following general requirements have been submitted within this application:

Summary of Unit(s)

Type of Unit	Number of Units
Single Family Unit	
Detached Condo	1
Accessory Dwelling	0

Summary of Square Footage

Calculated in "Livable Area". Space in a structure for living, sleeping, eating, cooking, to include bathrooms, toilet compartments, closets, and halls as measured from exterior wall to exterior wall. Storage areas, utility areas, garages and similar areas are not considered.

Type of Unit	Total Square Footage
Single Family Unit	6737
Accessory Dwelling	0
% of Accessory to Single Family	0
Total	6737

Wood Burning Device Permit

If a wood burning fireplace is proposed, a copy of the Wood Burning Device Permit must be included with this application.

Proof of Ownership (Reference for Item 3)

Please submit complete copies of the following stamped by an architect or engineer licensed in the state of Colorado, except the model, along with a completed application form, completed checklist, and appropriate fees. Within the checklist below, please place a checkmark beside the information submitted, and indicate where the information can be found (i.e. Plan A.1) If not applicable (N/A) is entered in a box, please explain:

Application Form, Development Checklist and Fees.

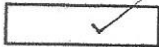

Proof of ownership of subject property. Demonstration of ownership shall be constituted by current written proof of who or what entity holds title to all the land(s) depicted on any plat or plan filed with the County, with the minimum proof of ownership consisting of certification by a title company authorized to conduct business in the State of Colorado. The certification shall be issued not more than thirty (30) days prior to the date of submittal of the application. If the land is owned by a third-party, corporation or similar legal entity designating an individual or entity to act in the Corporation's or similar legal entity's behalf, a proof of agency shall be required and consist of a Corporate Resolution, or similar legal document, designating the individual or entity to act as agent. The application must be signed by the property owner or an officer of the Corporation or legal entity.

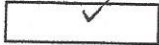

Vicinity Map: A Vicinity Map indicating the location of the subject property and other properties within four hundred feet (400') or one hundred fifty feet (150') if located within the Village Core.

Existing Conditions Plan (Reference for Item 8)

GAN-JUAN

SURVEY
DRAWINGS

A-0

Survey: A topographic survey stamped by a surveyor licensed within the State at a **minimum scale of one-inch equals twenty feet (1"=20')**. The survey should be representative of existing conditions of the site and shall have minimum contour intervals of no greater than two-feet (2').

- Existing trees or groups of trees having trunks with diameters of four inches (4") or more at one foot (1') above natural grade.
- N/A Rock outcroppings.
- N/A Wetlands.
- Other significant natural features
- Slopes of thirty percent (30%) or more shall be specifically identified.
- Footprint of all existing structures.
- The survey shall include ties to an established vertical datum (to be obtained from the department of planning and design review), property lines showing distances and basis of bearing, and all easements and setbacks.
- Easements and setbacks.
- Locations of all utilities, including existing sources and proposed service lines from sources to the structures.

Proposed Development Plan (Reference for Item 9)

A-1.0

Site Plan: A site plan, drawn at a minimum scale of one inch to twenty feet (1"=20') (unless otherwise approved by staff).

- Existing and proposed building footprints and all other structures, including decks, patios, canopies, walls, hot tubs, pools, etc.
- Showing existing and finished grades at two-foot (2') contours.
- Rock outcroppings and other significant features
- Locations of landscaped areas.
- Service areas and storage areas.
- Pedestrian walks, driveways with proposed grades, parking spaces.
- Address monument location.
- All retaining structures.
- Existing and proposed elevations of the top of roof ridges.
- Locations of ingress and egress, and the directions of traffic flow into and out of as well as within parking and loading areas, the location of loading berth(s) (where applicable), and areas for turning and maneuvering vehicles.

A-1.0

Grading and Drainage Plan: A grading and drainage plan at a minimum scale of one inch equals twenty feet (1"=20') (unless otherwise approved by staff).

- Showing existing and finished grades at two-foot (2') contours.
- Areas proposed for cuts or fill, and projections of the volumes of materials.
- Proposed Erosion and Sediment Control features including drainage swales.
- Any proposed slopes greater than 3:1.
- Locations of any existing natural surface drainage patterns.
- All proposed building footprints and other structures including decks, patios, walls, hot tubs, pools and retaining structures.
- A clear and detailed demonstration of the existing drainage on the subject property and the proposed drainage after development.

- N/A Multi-Family, Mixed-use or Commercial projects are required to submit a drainage study prepared by a Colorado Professional Engineer with storm-water calculations for a 25-year storm event.

N/A

Phasing Plan: A phasing plan is required for any development that will not complete the entire proposed project in one phase. A complete master site plan, grading plan, utility plan, landscape plan, and parking plan for the entire project must be submitted which clearly indicates what will be completed in each phase in its entirety.

A-1.5

CONSULTANT
DRAWING
PENDING

Lighting Plan: An outdoor lighting plan, drawn at a minimum scale of one inch equals twenty feet (1"=20') (unless otherwise approved by staff). In addition to locating this information graphically on a plan, the applicant shall provide the information on the application form and provide manufacturer's cut-sheets for the DRB file.

Location, height above grade, type of illumination (such as incandescent, halogen, etc.)

PENDING Source lumens.

PENDING Luminous area for each light source which is proposed.

Architectural Requirements

The following statements, representative elevations and details have been submitted within this application:

A-3.0

Statement of Building Height

A-3.1

Maximum Height Limit

Proposed	Required By Zone
40.5'	45'

Maximum Average Height

25'	30'
-----	-----

N/A

Architectural Feature(s) which exceeds Maximum Height Limit
Requires specific DRB approval

A-3.M

Statement of Stone Area and Stone Area Calculations

Exterior wall material percentages

Percentage of stone	40%
Percentage of stucco	0
Percentage of wood	29.5%
Percentage of accent material	3.5%
Percentage of fenestration	27%

North Elevation

Total sq. ft. of exterior wall	1283
Total sq. ft. of stone	762
Total sq. ft. of stucco	0
Total sq. ft. of wood	369
Total sq. ft. of accent material	28
Total sq. ft. of fenestration	124

East Elevation

Total sq. ft. of exterior wall	1607
Total sq. ft. of stone	423
Total sq. ft. of stucco	0
Total sq. ft. of wood	738
Total sq. ft. of accent material	105
Total sq. ft. of fenestration	341

South Elevation

Total sq. ft. of exterior wall	1315
Total sq. ft. of stone	501
Total sq. ft. of stucco	0
Total sq. ft. of wood	458
Total sq. ft. of accent material	0
Total sq. ft. of fenestration	356

West Elevation

Total sq. ft. of exterior wall	3049
Total sq. ft. of stone	1243
Total sq. ft. of stucco	0
Total sq. ft. of wood	578
Total sq. ft. of accent material	92
Total sq. ft. of fenestration	1131

Total Building

Total sq. ft. of exterior wall	7254
Total sq. ft. of stone	2934
Total sq. ft. of stucco	0
Total sq. ft. of wood	2143
Total sq. ft. of accent material	225
Total sq. ft. of fenestration	1952

Architectural Plans: Architectural plans drawn at a minimum scale of 1/8" = 1' (unless otherwise approved by staff).

A-2..... Floor plans labeled and dimensioned and drawn in sufficient detail.

A-3..... All elevations of proposed structures.

A-1.0 Existing and finished grades a minimum of five (5) feet out from the building or to the property line.

A-3.0 Building height.

A-2.4 Roof forms and pitch (primary and secondary).

Location and type of all doors and windows.

A-3.1 Details of recess of windows and doors within stucco or stone walls.

Exterior surfacing materials.

Snow and ice shed prevention devices.

SEE SPEC. Exterior lighting detail.

Colored rendering or two-colored elevations.

Statement of building height and elevations supporting the calculations.

A-3-M Statement of stone area and stone calculations and elevations supporting the calculations.

AT MEETING Scale model illustrating building mass and proportion in relationship to development on adjacent parcels, existing vegetation and site contours.

SEE PHOTOS Color and material sample board. (to include windows, doors and exterior lighting.) Provide photos, brochures and cut sheets.

SEE DETAIL Address monument design to include lighting.

A-1.3 Landscape Plan: A detailed landscape plan at a minimum scale of one inch equals twenty feet (1"=20') (unless otherwise approved by staff), with two foot contours.

Showing existing and proposed grading.

Existing vegetation.

Limits of tree removal, locations of all new tree plantings.

Ground cover.

Revegetation and proposed treatments.

Plant schedule identifying all plant material by type (scientific nomenclature, quantity and size).

Seeding (type, varieties, mixes, rates).

Soil preparation specifications.

Turf areas.

Special landscape features.

Retaining structures, to include type of wall, grades, elevations of top and bottom of wall every twenty (20') feet, footings and facing materials.

A-1.4 Irrigation Schedule demonstrating the type and size of all pipes, heads, valves and controllers; Location and description of connection to plumbing; and, Location of water sensors.

A-1.2 Construction Staging Plan: A construction staging plan, drawn at a minimum scale of one inch equals twenty feet (1"=20') (unless otherwise approved by staff).

The limits of construction activity.

Limits of excavation.

Limits of tree removal.

Identification of trees to remain within the limits of construction.

Location of construction fencing and detail of methods to protect the remaining trees and any other vegetation.

Location of building material storage areas, cut and slash storage and route of removal.

- Construction parking (location and amount).
- Locations of portable washrooms.
- Construction trailer (location and size).
- Location of a trash container and route of removal.
- Bear-proof container for all food waste.

? **A detailed construction staging manual, if determined to be necessary by DRB at Initial Architectural Site Review, containing all information requested by the DRB at Initial Architectural Site review.**

n) **Photographs:** Photographs of the subject site from the access road or tract, and if applicable, from any adjacent golf course and/or ski run, and any specific features of the site which may impact or be impacted by the proposed project.

o) Any additional material or information as deemed necessary by the Planning Department for proper review of the application. If applicable, please list this information that has been submitted.

Engineered Infrastructure Plan (Referenced for Item 10)

? Signed Landscape, Paving and Construction Staging Agreement

N/A Wetlands Consultant Report (if required)

Soils Investigation and Foundation Recommendations

A-1-1 A utility plan, drawn at a minimum scale of one inch equals twenty feet (1"=20') (unless otherwise approved by staff).

Design Variation (Referenced for Item 12)

The following area requested Variance to the Community Development Code (CDC) for DRB consideration (such consideration may require the final approval of the Town Council of the Town of Mountain Village).

Please submit appropriate Variance application and checklist along with this application.

N/A Section: _____ Requirement: _____ Variance Request: _____

I hereby certify that all information contained within this application and all plans required as a part of this Final Plan Application are accurate.



Owner/Owner Agent

12/30/20

Date



EXISTING FOUNDATION #1

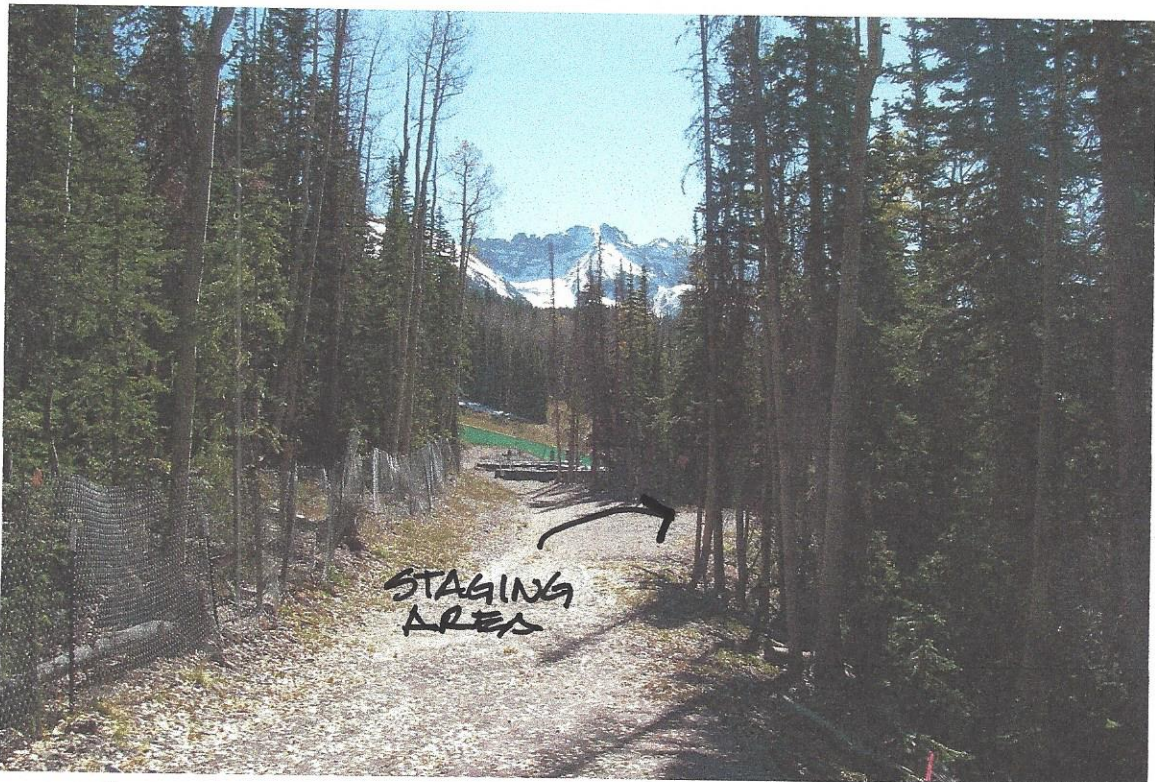

ACCESS ROAD TO SITE

61 207

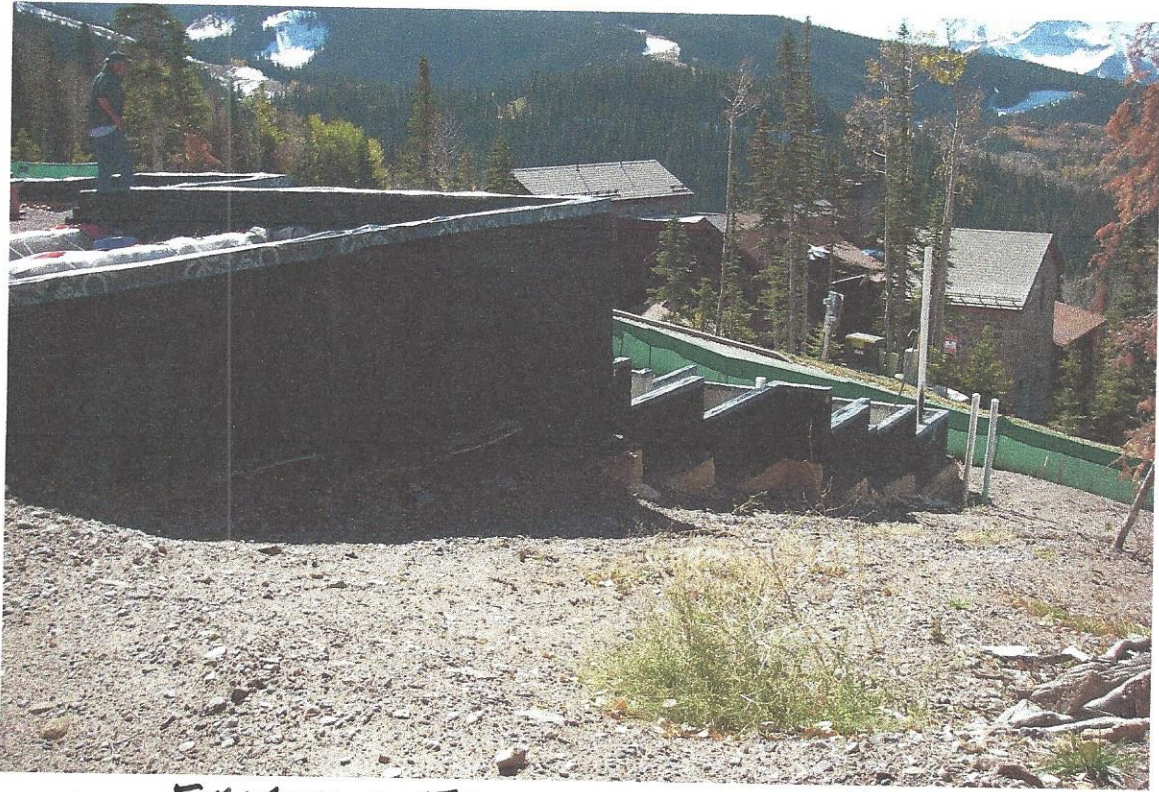

EXISTING FOUNDATION #2

Lot 19



EXISTING FOUNDATION & AUTO COURT



EXISTING FOUNDATION #3

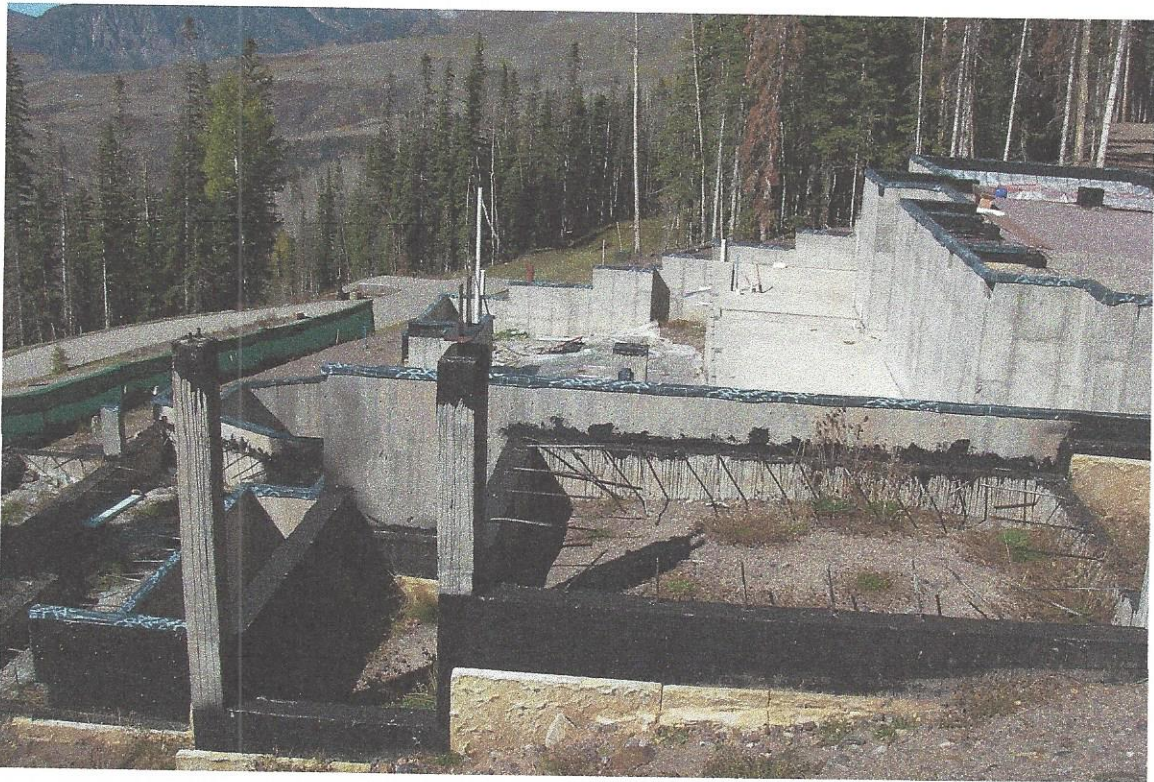

EXISTING FOUNDATION #4

LOT 19

LOT 19

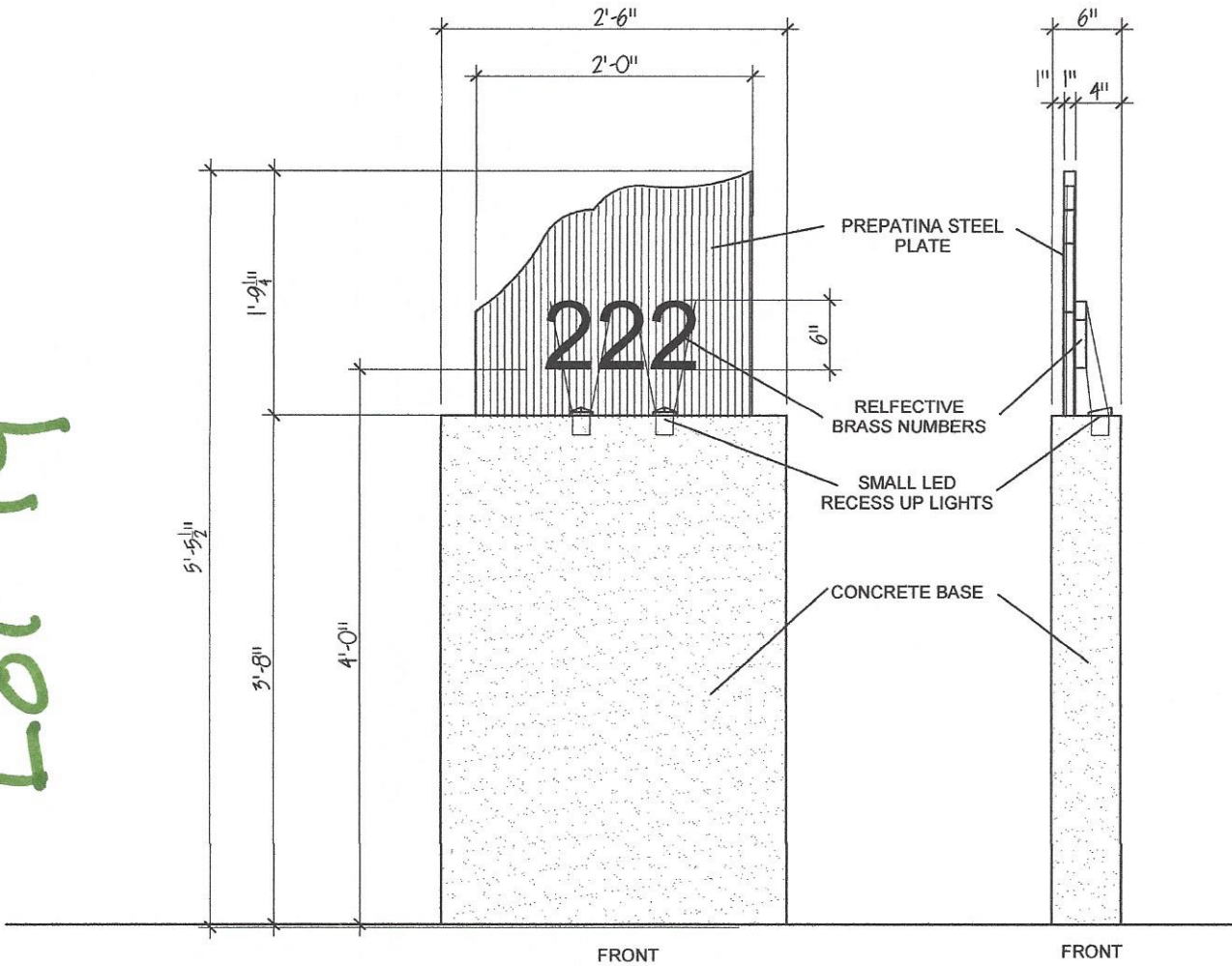

ADDRESS MONUMENT

The Quadrate modern outdoor wall sconce creates uplight to softly graze architectural wall surfaces. The downlight accents the extended back plate, while the clean, modern LED lighting design is elegantly simple yet very impactful. Cleverly hidden hardware ensures a clean look.

Outstanding protection against the elements:

- Powder coat finishes
- Stainless Steel mounting hardware
- Impact-resistant, UV stabilized frosted acrylic lensing

SPECIFICATIONS

DELIVERED LUMENS	383
WATTS	16
VOLTAGE	120V
DIMMING	ELV
LIGHT DISTRIBUTION	Symmetric
MOUNTING OPTIONS	Wall
CCT	Warm Color Dimming (3000K - 2200K)
CRI	90
COLOR BINNING	3-Step
BUG RATING	N/A
DARK SKY	Compliant
WET LISTED	IP65
GENERAL LISTING	ETL
CALIFORNIA TITLE 24	Can be used to comply with CEC 2016 Title 24 Part 6 for outdoor use. Registration with CEC Appliance Database not required.
START TEMP	-30°C
FIELD SERVICEABLE LED	Yes
CONSTRUCTION	Aluminum
HARDWARE	Stainless Steel
FINISH	Powder Coat
LED LIFETIME	L70; 70,000 hours
WARRANTY*	5 years
WEIGHT	3.5 lbs.

* Visit techlighting.com for specific warranty limitations and details.



QUADRATE
shown in bronze

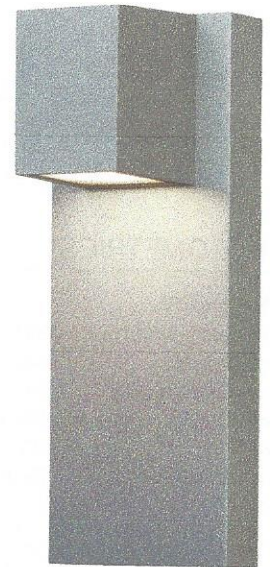

QUADRATE
shown in silver

EXTERIOR SCONCE

LOT 19

ORDERING INFORMATION

700WSQDR	FINISH	LAMP
	Z BRONZE	LEDLW LED 90CRI, 3000K-2200K, 120V
	I SILVER	

LOT 19

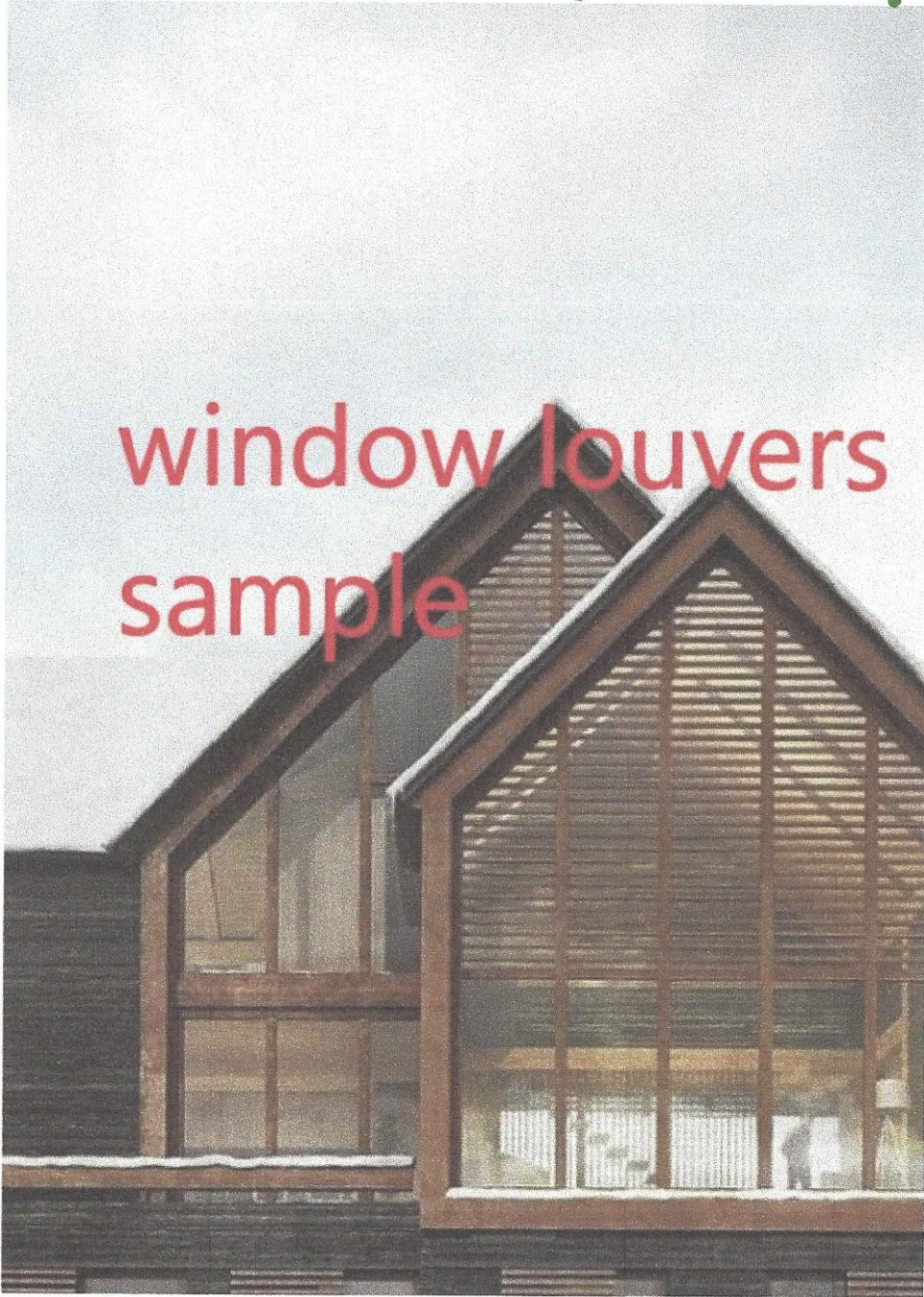

window louvers
sample

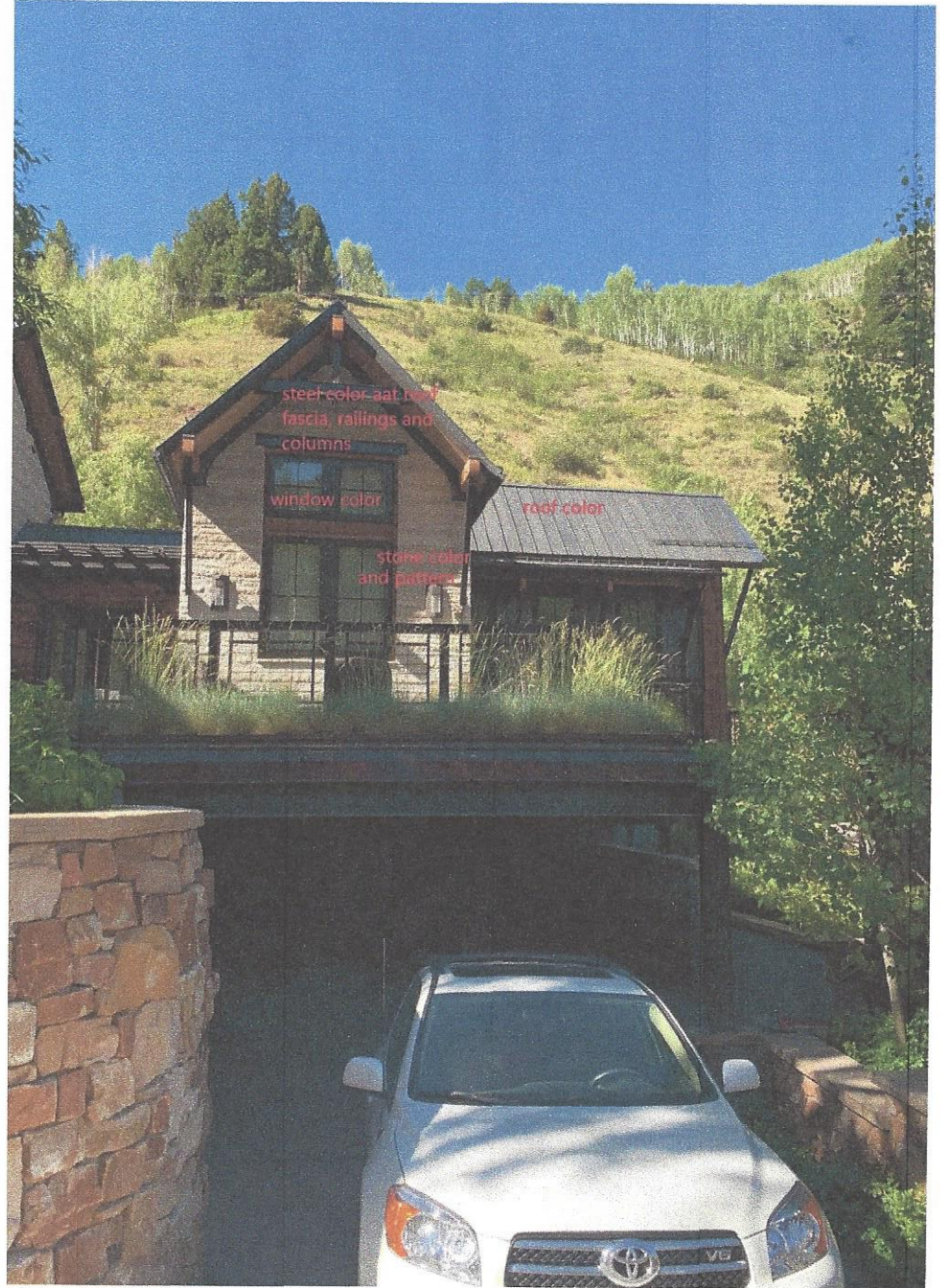

EXTERIOR MATERIAL SAMPLES

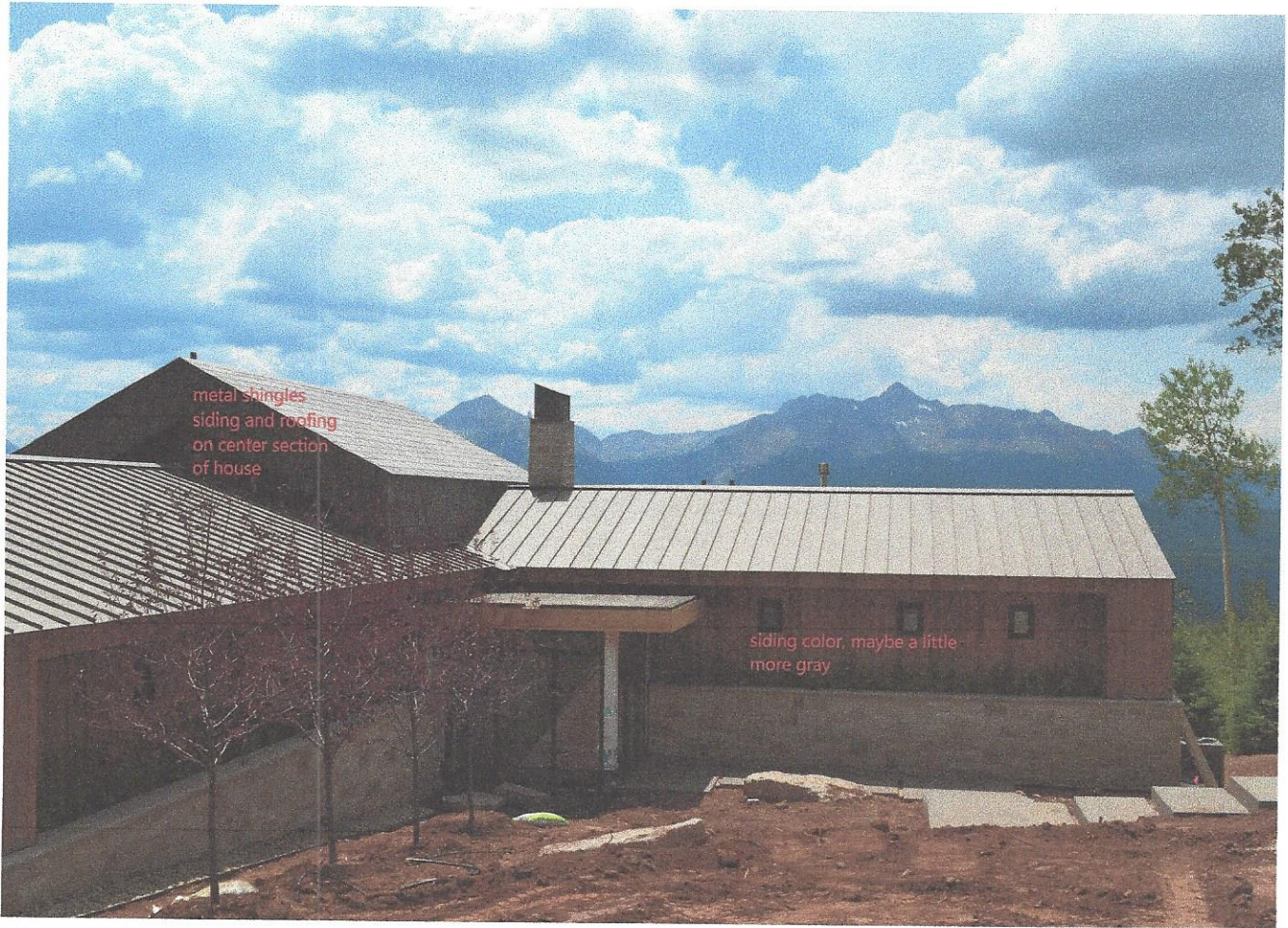

EXTERIOR MATERIAL SAMPLES

LOT 19

LUSK RESIDENCE THE RIDGE LOT 19

TOWN OF MOUNTAIN VILLAGE
TELLURIDE, COLORADO

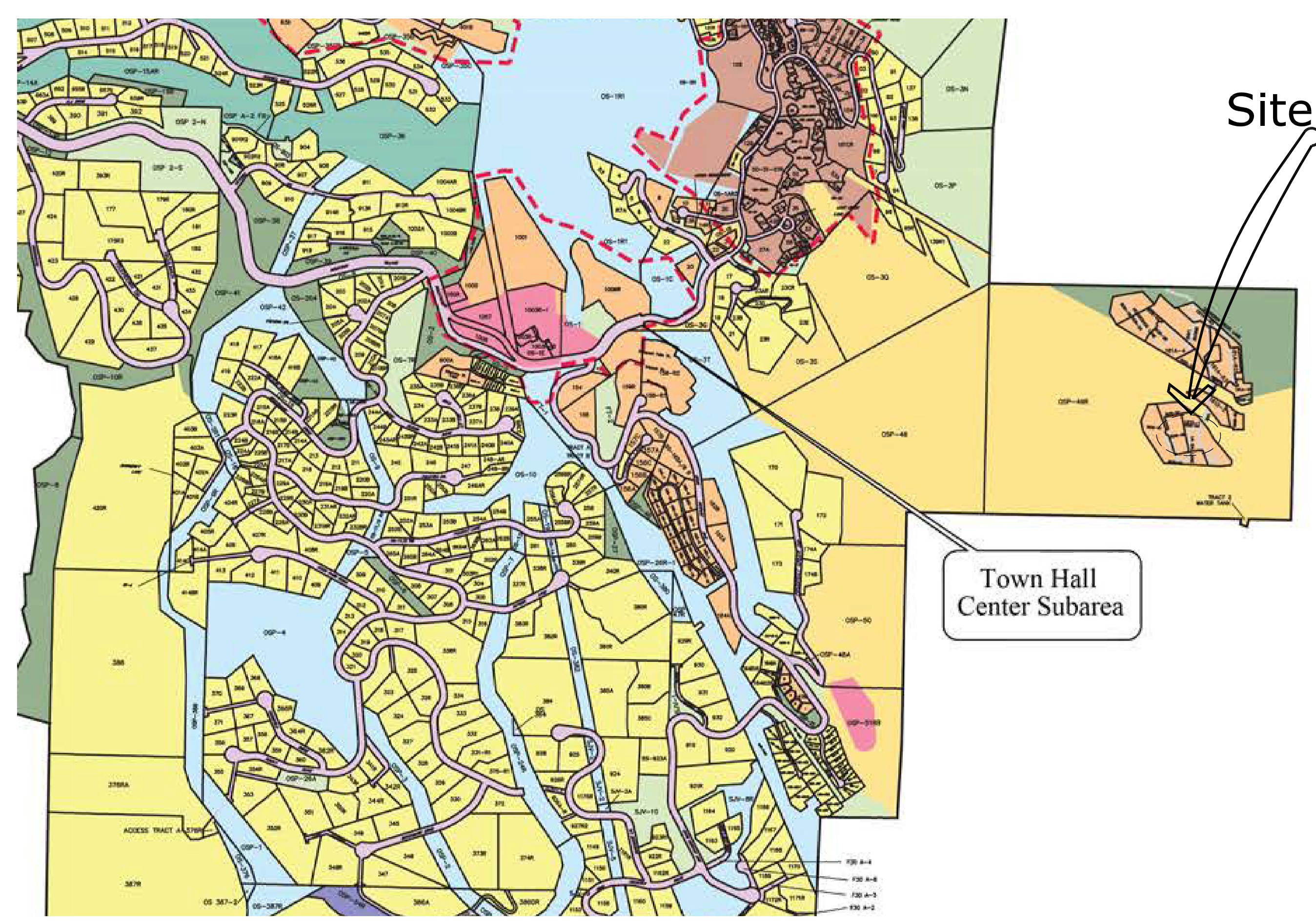
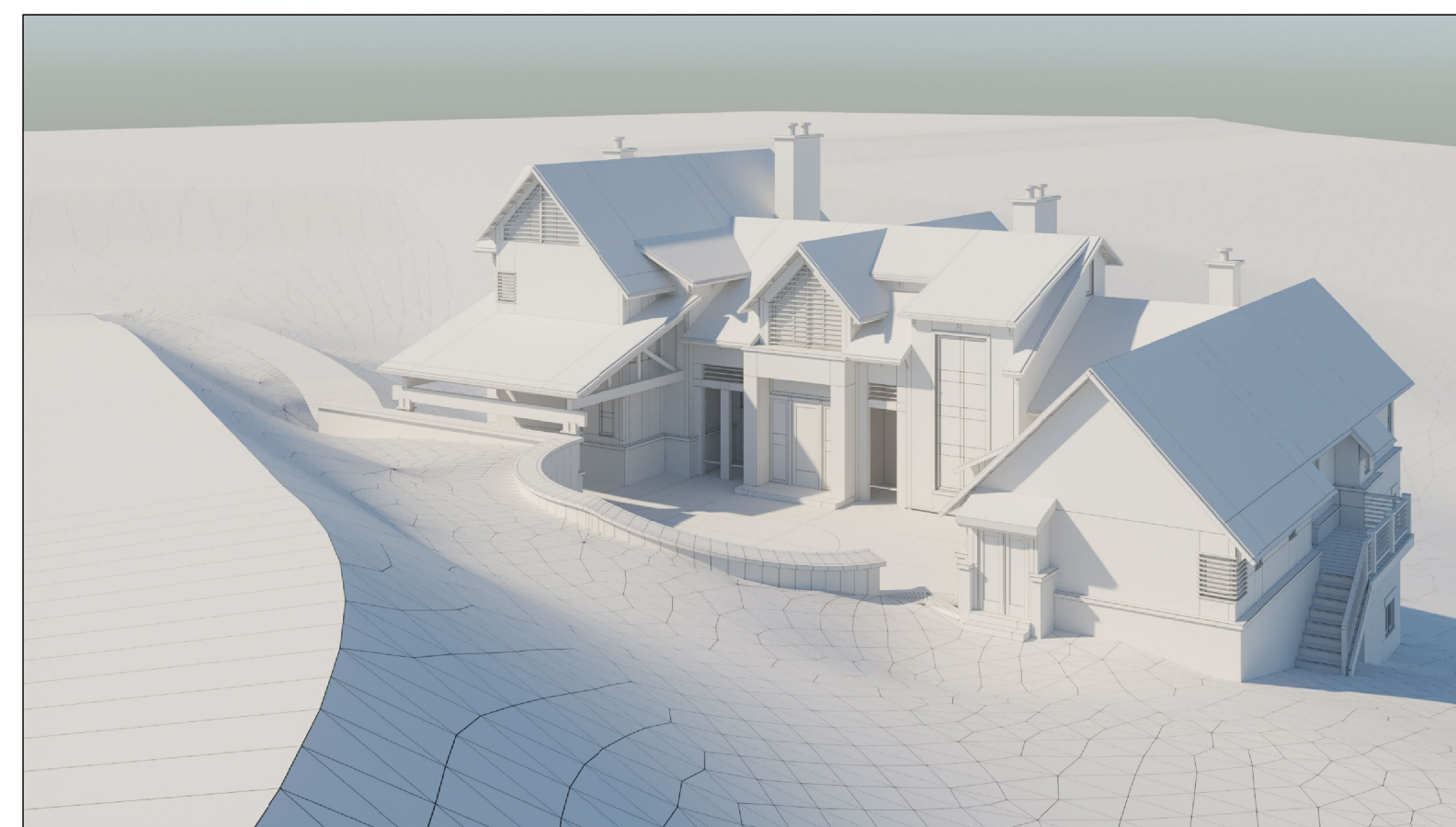

VICINITY MAP

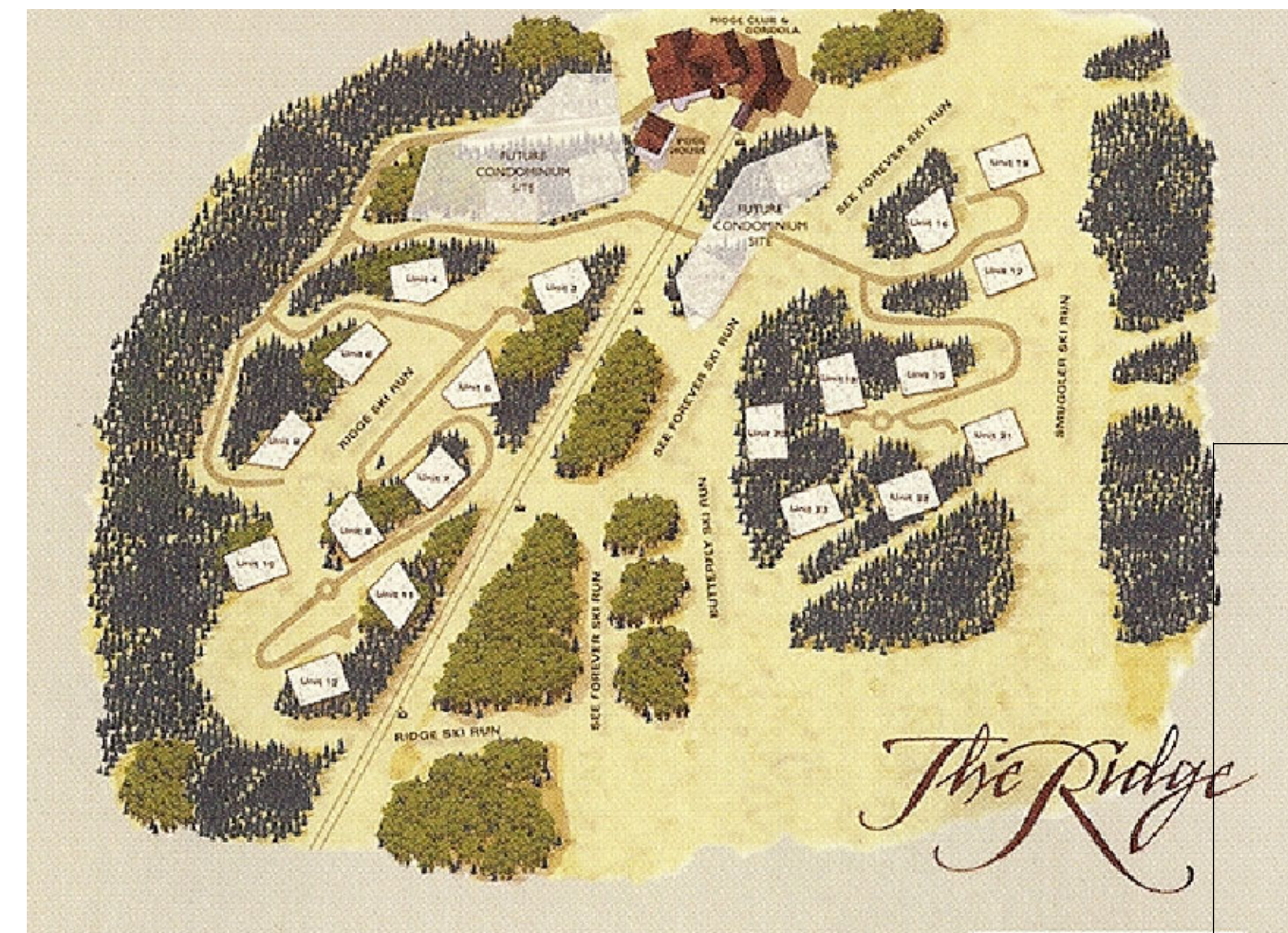

PROJECT SUMMARY - 12.23.20	
SINGLE FAMILY DWELLING UNIT - LOT 19	
LOWER LIVING	2,692 S.F.
MAIN LIVING	2,820 S.F.
UPPER LIVING	1,225 S.F.
TOTAL LIVING	6,737 S.F.
GARAGE	416 S.F.
MECH	128 S.F.
TOTAL	544 S.F.
TOTAL BUILDABLE	7,281 S.F.
LOWER LEVEL PATIO	700 S.F.
MAIN LEVEL DECKS	800 S.F.
MAIN LEVEL PATIO	140 S.F.
UPPER LEVEL DECK	91 S.F.
TOTAL EXT. SURFACE	1,731 S.F.
TOTAL CART COURT	1,760 S.F.

Lot 161-D1 TMV Lot 19
RIDGELINE LOT AREAS
Maximum ht. 45'
Maximum avg. ht. 30'
Parking req. 1 space offsite

PROJECT TEAM:

OWNER:

TOMMY & SLOAN LUSK
6750 Poplar Avenue, Suite 300
Memphis, TN 38138
Mobile) 901-336-2090

ARCHITECT:

MORTON ARCHITECTS INC.
STEVE MORTON - PRINCIPAL

221 S. PINE ST.
P.O. BOX 3561
TELLURIDE, CO 81435
970.708.2246

smorton@mortonarchitects.com

CONTRACTOR:

SKETCH DRB SUBMITTAL
12-30-20

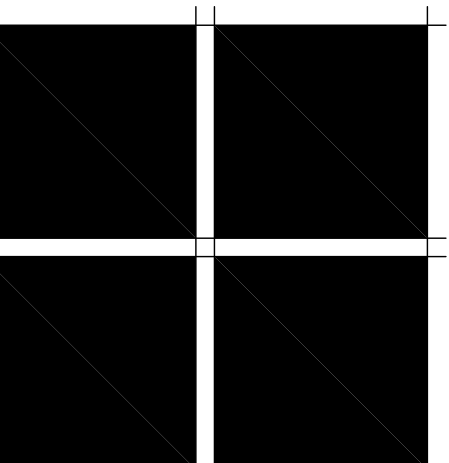

COPYRIGHT
All designs, ideas, arrangements and plans indicated by these drawings and specifications are the property and copyright of the Architect and shall neither be used on any other work nor be used by any other person for any use whatsoever without written permission. Written dimensions shall take precedence over scaled dimensions and shall be verified at the site. Any dimensional discrepancies shall be brought to the attention of the Architect prior to the commencement of the work.

ISSUE LOG	
Sketch DRB submittal	12-29-20

FILE NAME

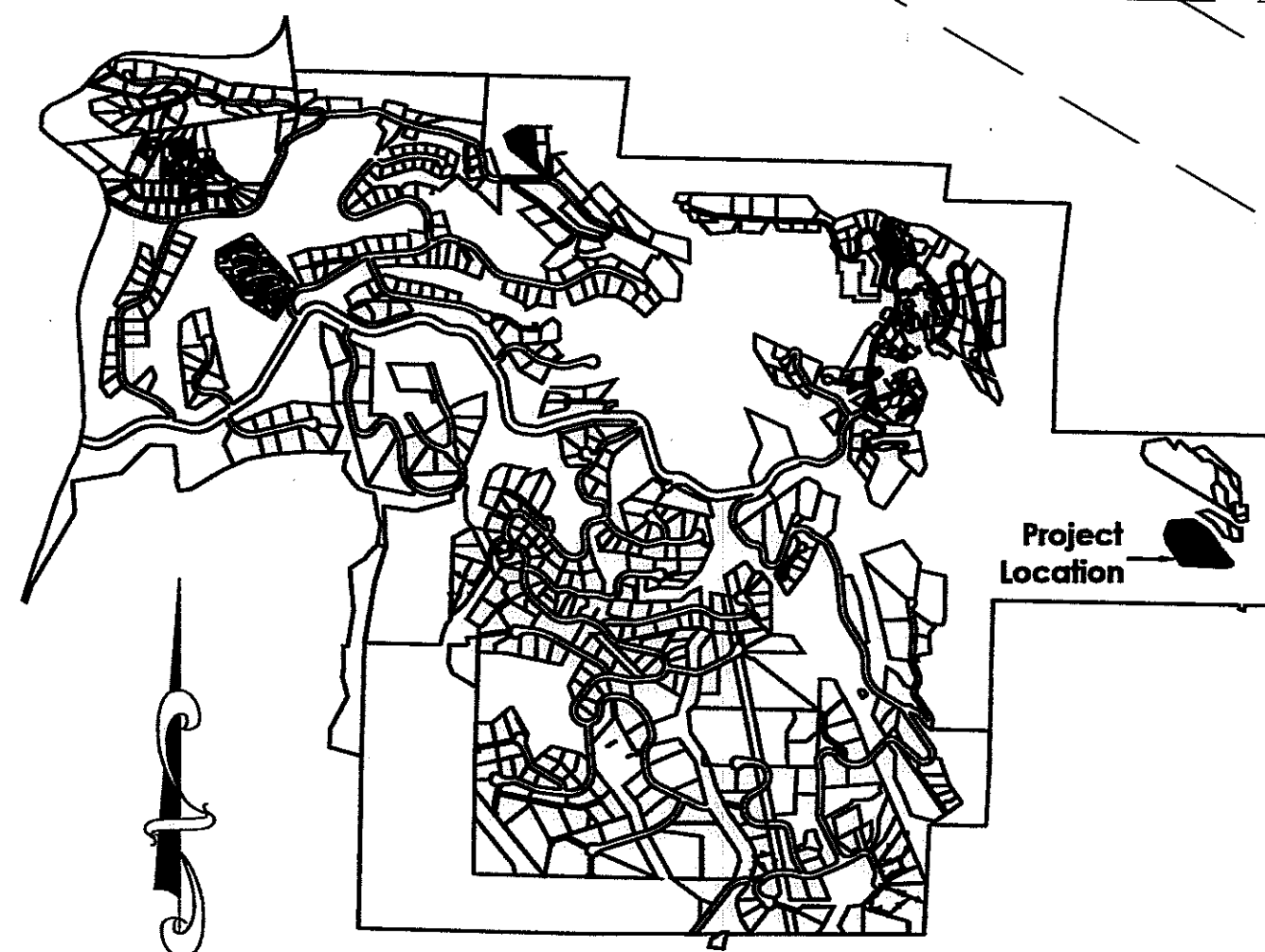

Vicinity Map
TOWN OF MOUNTAIN VILLAGE,
STATE OF COLORADO.
NOT TO SCALE

NW 1/16 CORNER SECTION
2, T.42 N., R.9 W., NMPM

UNCOMPAGHRE NATIONAL FOREST

C-N 1/16 CORNER SECTION
2, T.42 N., R.9 W., NMPM

TERMS, AGREEMENTS, PROVISIONS, CONDITIONS AND OBLIGATIONS OF
RIDGE ROAD EASEMENT AGREEMENT (TELSKI/ST. SOPHIA)
RECORDED JULY 15, 2003 AT RECEPTION NO. 358716 AND THE 1st
SUPPLEMENT TO THE RIDGE ROAD EASEMENT AGREEMENT (TOSI/ST.
SOPHIA) RECORDED APRIL 5, 2004 AT RECEPTION NO. 365189

HATCHED AREA INDICATES
1st AMENDMENT TO UTILITY
SERVICE LINE EASEMENT
AGREEMENT REC. NO.
358715
G.C.E.

1st SUPPLEMENT TO THE
RIDGE ROAD EASEMENT
AGREEMENT REC. NO. 365189
G.C.E.

TRACT OSP-49R

LOT 161A-4

TERMS, AGREEMENTS,
PROVISIONS, CONDITIONS AND
OBLIGATIONS OF RIDGE SKIWAY
EASEMENT AGREEMENT
(TELSKI/ST. SOPHIA) RECORDED
JULY 15, 2003 AT RECEPTION
No. 358714

HATCHED AREA 1st
AMENDMENT INDICATES
UTILITY SERVICE LINE
EASEMENT AGREEMENT REC.
NO. 358715 G.C.E.

Utility Extension
Easement Agreement
recorded march 04, 2011
at Rec. No. 416752

LOT 161A-R2

UNCOMPAGHRE
NATIONAL FOREST

TRACT OSP-49R

CONDOA EASEMENT BOOK 489 PAGE 1007

LOT 161A-R3

HATCHED AREA INDICATES
1st AMENDMENT TO
UTILITY SERVICE LINE
EASEMENT AGREEMENT
REC. NO. 358715 G.C.E.

TERMS, AGREEMENTS,
PROVISIONS, CONDITIONS AND
OBLIGATIONS OF TUNNEL/BRIDGE
EASEMENT AGREEMENT
RECORDED JULY 14, 2000 AT
RECEPTION NO. 335493

TRACT OS161-R4

LOT 161A-1R

TRACT OS161-R1

HATCHED AREA INDICATES
TERMS, AGREEMENTS,
PROVISIONS, CONDITIONS AND
OBLIGATIONS OF UTILITY SERVICE
LINE EASEMENT AGREEMENT
RECORDED JULY 14, 2000 AT
RECEPTION NO. 335495 AS
MODIFIED BY 1st AMENDMENT TO
UTILITY SERVICE LINE EASEMENT
AGREEMENT (TELSKI/ST. SOPHIA)
RECORDED JULY 15, 2003 AT
RECEPTION NO. 358715.

TUNNEL/BRIDGE EASEMENT
AGREEMENT REC. NO.
335493 G.C.E.

LOT 161D-2

TERMS, AGREEMENTS,
PROVISIONS, CONDITIONS AND
OBLIGATIONS OF SKIWAY
EASEMENT AGREEMENT
(TELSKI/ST. SOPHIA)
RECORDED JULY 14, 2000
AT RECEPTION NO. 335496

TRACT OS161-R2

LOT 161D-1

TERMS, AGREEMENTS, PROVISIONS,
CONDITIONS AND OBLIGATIONS OF
NON-CONDOA ACCESS EASEMENT
AGREEMENT RECORDED JULY 14,
2000 AT RECEPTION NO. 335491

CENTER 1/4 CORNER
SECTION 2, T.42 N., R.9 W.,
NMPM

TERMS, AGREEMENTS,
PROVISIONS, CONDITIONS
AND OBLIGATIONS OF
COMMUNICATION LINE
EASEMENT AGREEMENT
(TELSKI/ST. SOPHIA)
RECORDED JULY 15, 2003
AT RECEPTION NO. 358717.

TRACT OSP-49R

GRAPHIC SCALE

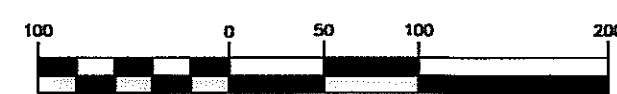

(IN FEET)
1 inch = 100 ft.

UNCOMPAGHRE NATIONAL FOREST

C-N-S 1/64 CORNER
SECTION 2, T.42 N., R.9 W.,
NMPM



8th SUPPLEMENTED AND AMENDED PLANNED COMMUNITY PLAT OF THE RIDGE AT TELLURIDE - PHASES 1, 2, 3, 4, 5, 6, 7, 8, AND 9

LOCATED WITHIN SECTION 2,
T.42N., R.9W., N.M.P.M
COUNTY OF SAN MIGUEL
STATE OF COLORADO

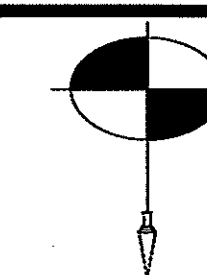

SAN JUAN SURVEYING
SURVEYING * PLANNING
102 SOCIETY DRIVE TELLURIDE, CO. 81435
(970) 728-1128 (970) 728-9201 fax
office@sanjuansurveying.net

DATE:	03/20/2019
JOB:	04068
DRAWN BY:	CRK
CHECKED BY:	ESS
REVISION DATES:	
SHEET:	2 OF 6



I, Christopher R. Kennedy, being a Colorado Licensed Land Surveyor, do hereby certify that this partial Topographic Survey of Lot 161D-1, portions of Units 18, 19, and 20, The Ridge at Telluride, was made by me and under my direct supervision, responsibility and checking. This Topographic Survey does not constitute a Land Survey Plat or Improvement Survey Plat as defined by Title 38, Article 31, C.R.S.

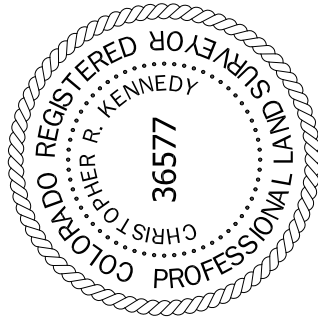

Christopher R. Kennedy, P.L.S. 36577

NOTICE:

According to Colorado Law, you must commence any legal action based upon any defect in this survey within three years after you first discover such defect. In no event shall any claim or cause of action be commenced more than ten years from the date of the certification shown hereon.

All visible improvements were located, however due to snow not all improvements may have been visible.

Elevations for contour data were derived from the Northwest corner of Unit 18, that elevation being 10393.93 feet.

View angles are given with zenith angles.

LEGEND

- FOUND #5 REBAR AND CAP, LS 24954
- FOUND #5 REBAR AND CAP, LS 36577
- ELECTRIC VAULT
- PHONE PEDESTAL
- CABLE TV BOX
- ⊗ FIRE HYDRANT
- ⊕ LIGHT POLE
- ⊗ ASPEN TREE (NUMBER INDICATES DIAMETER)
- ⊗ FIR TREE (NUMBER INDICATES DIAMETER)
- ⊗ PONDEROSA PINE (NUMBER INDICATES DIAMETER)
- ⊗ SEWER MANHOLE
- ⊗ 24" STORM DRAIN

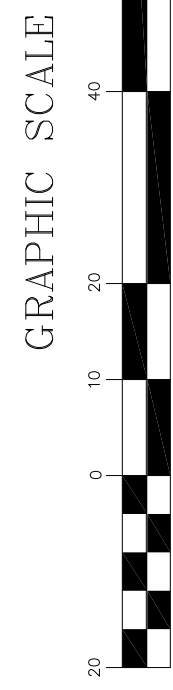
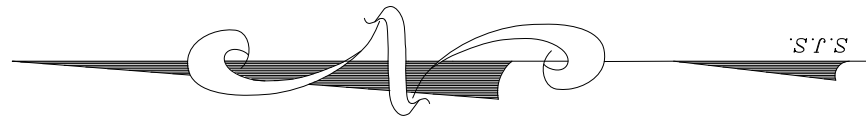

TOPOGRAPHIC SURVEY

LOT 161D-1, UNITS 18, 19, 20, THE RIDGE AT TELLURDE PHASE 3

SAN JUAN SURVEYING
 SURVEYING * PLANNING
 160 D. SOCIETY DRIVE TELLURIDE CO. 81455
 (970) 728-1128 (970) 728-9201 fax
 sanjuansurveying@yahoo.com

DATE:	11/14/2007
JOB:	07100
DRAWN BY:	TRW
CHECKED BY:	CRK
REVISION DATES:	03/11/08
SHEET:	1 OF 1

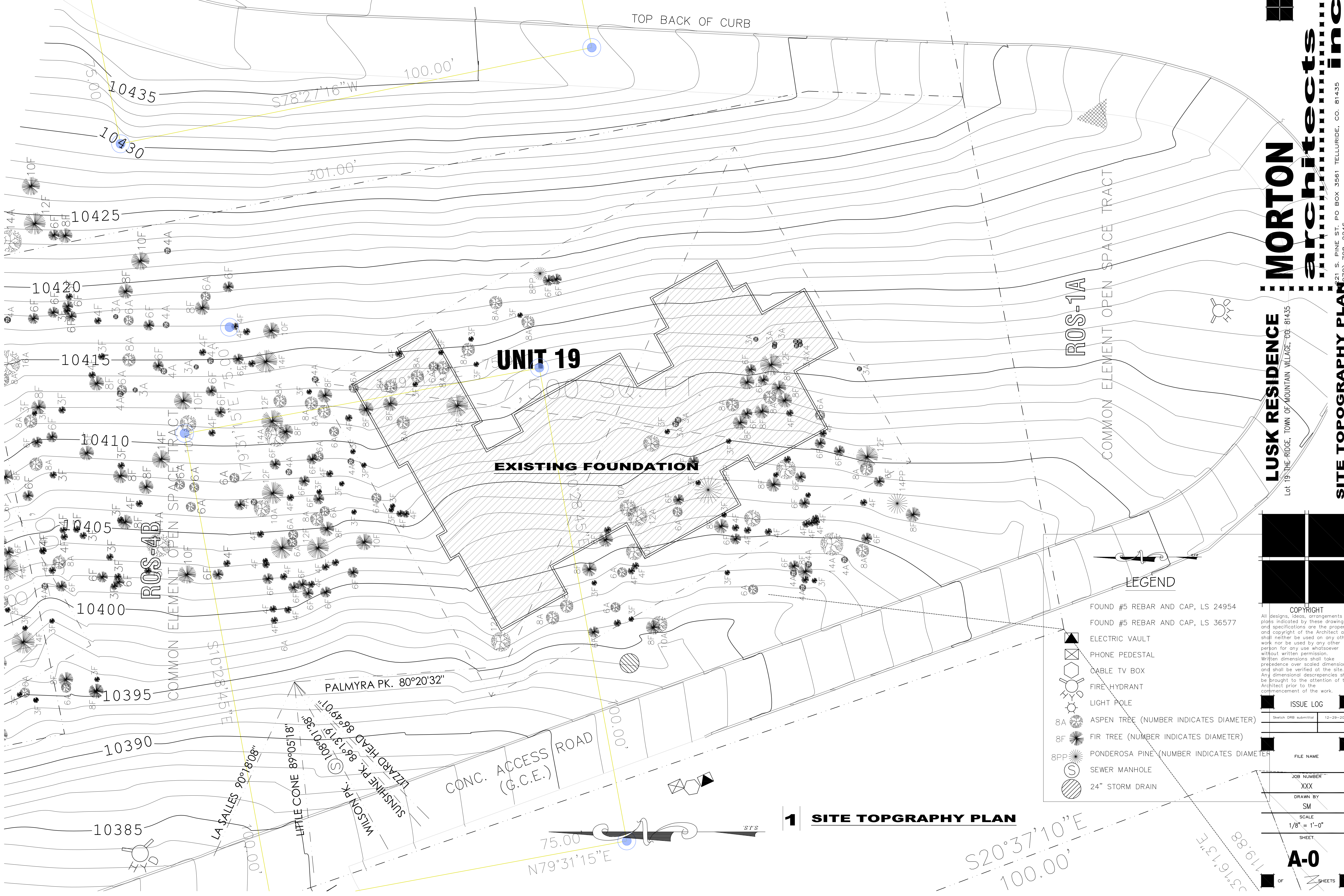

UNIT 19

EXISTING FOUNDATION

**CONC. ACCESS ROAD
(G.C.E.)**

ROS-1A

ROS-4B

LEGEND

- FOUND #5 REBAR AND CAP, LS 24954
- FOUND #5 REBAR AND CAP, LS 36577
- ELECTRIC VAULT
- PHONE PEDESTAL
- CABLE TV BOX
- FIRE HYDRANT
- LIGHT POLE
- 8A ASPEN TREE (NUMBER INDICATES DIAMETER)
- 8F FIR TREE (NUMBER INDICATES DIAMETER)
- 8PP PONDEROSA PINE (NUMBER INDICATES DIAMETER)
- SEWER MANHOLE
- 24" STORM DRAIN

COPYRIGHT
All designs, ideas, arrangements and plans indicated by these drawings and specifications are the property and copyright of the Architect and shall neither be used on any other work nor be used by any other person for any use whatsoever without written permission. Written dimensions shall take precedence over scaled dimensions and shall be verified at the site. Any dimensional discrepancies shall be brought to the attention of the Architect prior to the commencement of the work.

ISSUE LOG	
Sketch DRB submittal	12-29-20
FILE NAME	
JOB NUMBER	
XXX	
DRAWN BY	
SM	
SCALE	
1/8" = 1'-0"	
SHEET	
A-0	
OF SHEETS	

1 SITE TOPOGRAPHY PLAN

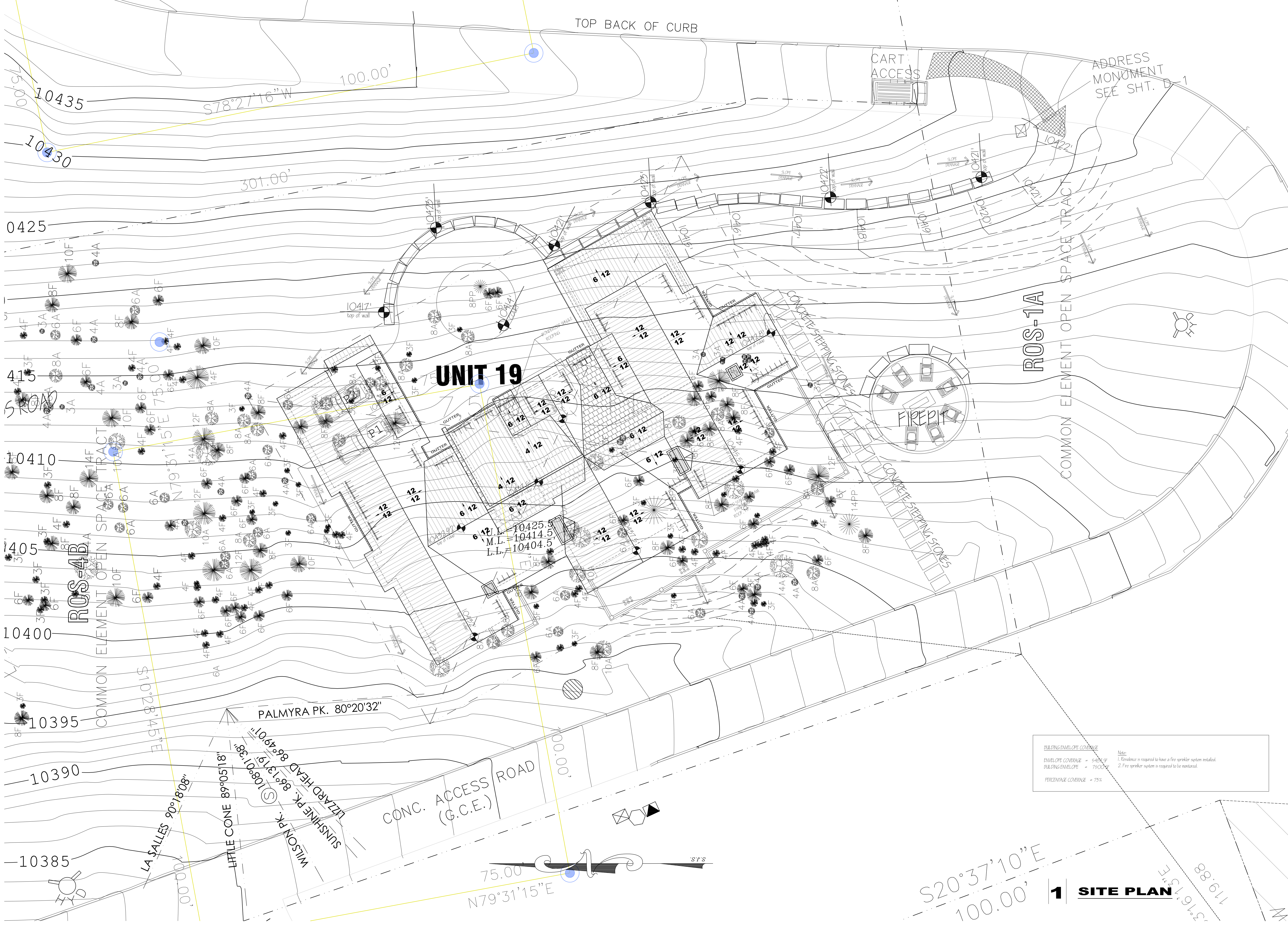

UNIT 19

FIRE PIT

ROS-1A

ROS-4B

BUILDING ENVELOPE COVERAGE
 ENVELOPE COVERAGE = 54.00%
 BUILDING ENVELOPE = 75.00%
 PERCENTAGE COVERAGE = 75%

Note:
 1. Residence is required to have a fire sprinkler system installed.
 2. Fire sprinkler system is required to be monitored.

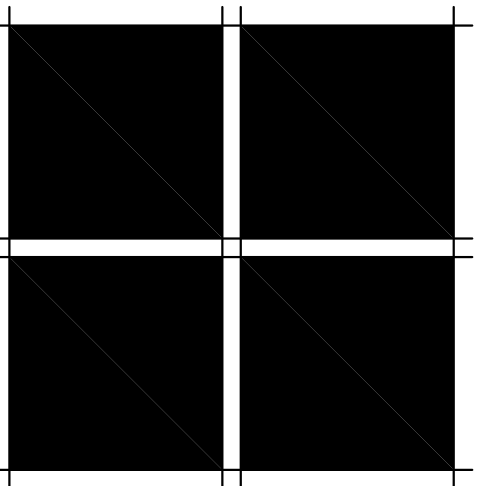

COPYRIGHT
 All designs, ideas, arrangements and plans indicated by these drawings and specifications are the property and copyright of the Architect and shall neither be used on any other work nor be used by any other person for any use whatsoever without written permission. Written dimensions shall take precedence over scaled dimensions and shall be verified at the site. Any dimensional discrepancies shall be brought to the attention of the Architect prior to the commencement of the work.

ISSUE LOG

Issue Description	Date
Sketch DRB submittal	12-29-20

FILE NAME

JOB NUMBER
XXX

DRAWN BY
SM

SCALE
1/8" = 1'-0"

SHEET

A-1.0
OF SHEETS

MORTON architects inc
 221 S. PINE ST. PO BOX 3561 TELLURIDE, CO. 81435
 (970) 768-2246

LUSK RESIDENCE
 Lot 19 THE RIDGE, TOWN OF MOUNTAIN VILLAGE, CO. 81435
SITE PLAN

1 SITE PLAN

S20°37'10"E
 100.00'

3°16'13"E
 179.88'

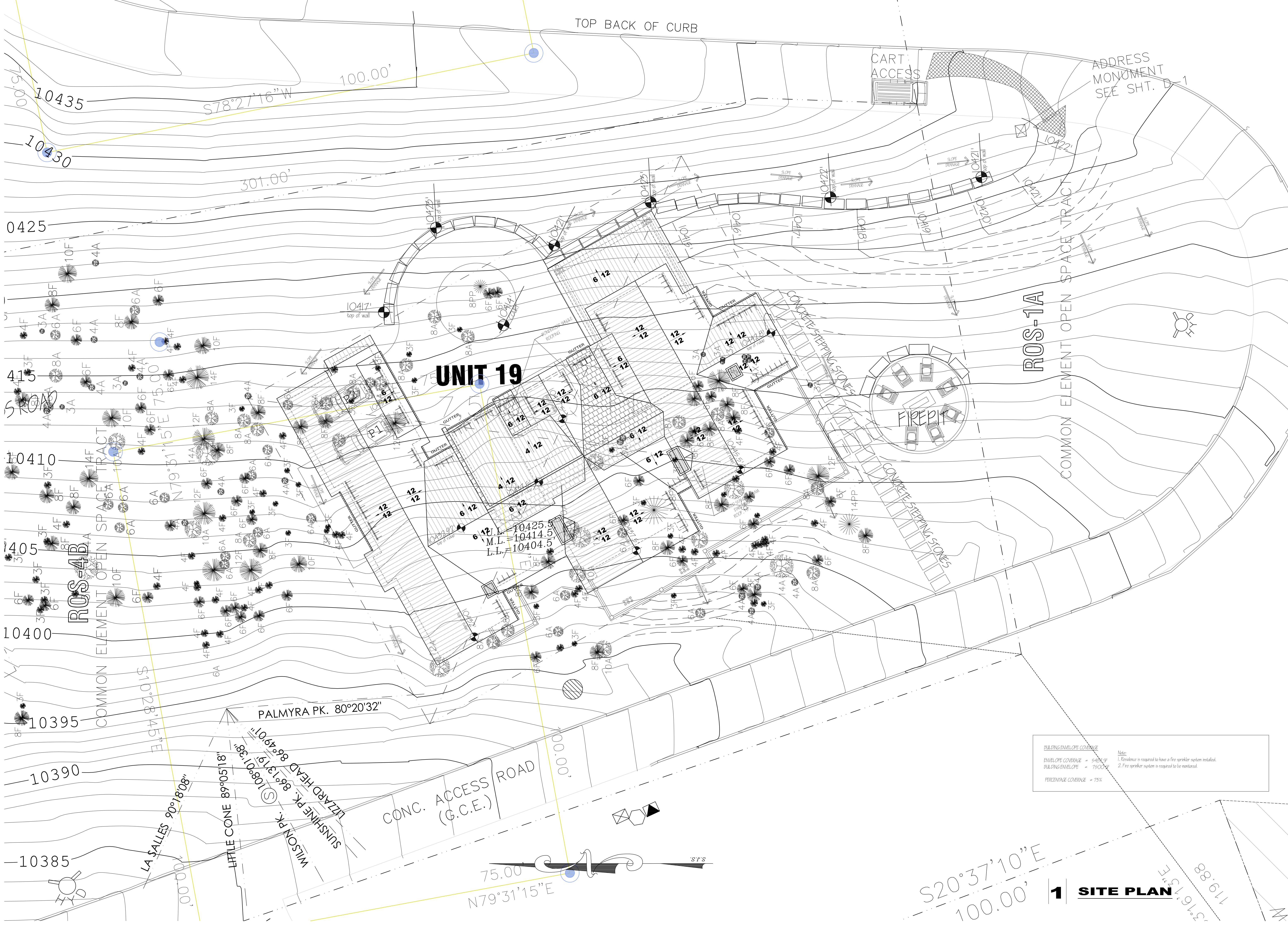

TOP BACK OF CURB

CART ACCESS

ADDRESS MONUMENT SEE SHT. D-1

10435
 S78°27'16"W
 100.00'

10430
 301.00'

0425

415
 S79°31'15"E
 75.00'

10410

10405

10400

10395

10390

10385

LA SALLES 90°18'08"
 100.00'

LITTLE CONE 89°05'18"
 108.013'

WILSON PK. 86°13'19"
 108.013'

PALMYRA PK. 80°20'32"
 86°49'07"

SUNSHINE PK. 86°13'19"
 108.013'

LIZARD HEAD 86°49'07"

CONC. ACCESS ROAD (G.C.E.)
 100.00'

75.00'
 N79°31'15"E

S20°37'10"E
 100.00'

3°16'13"E
 179.88'

S'1'S

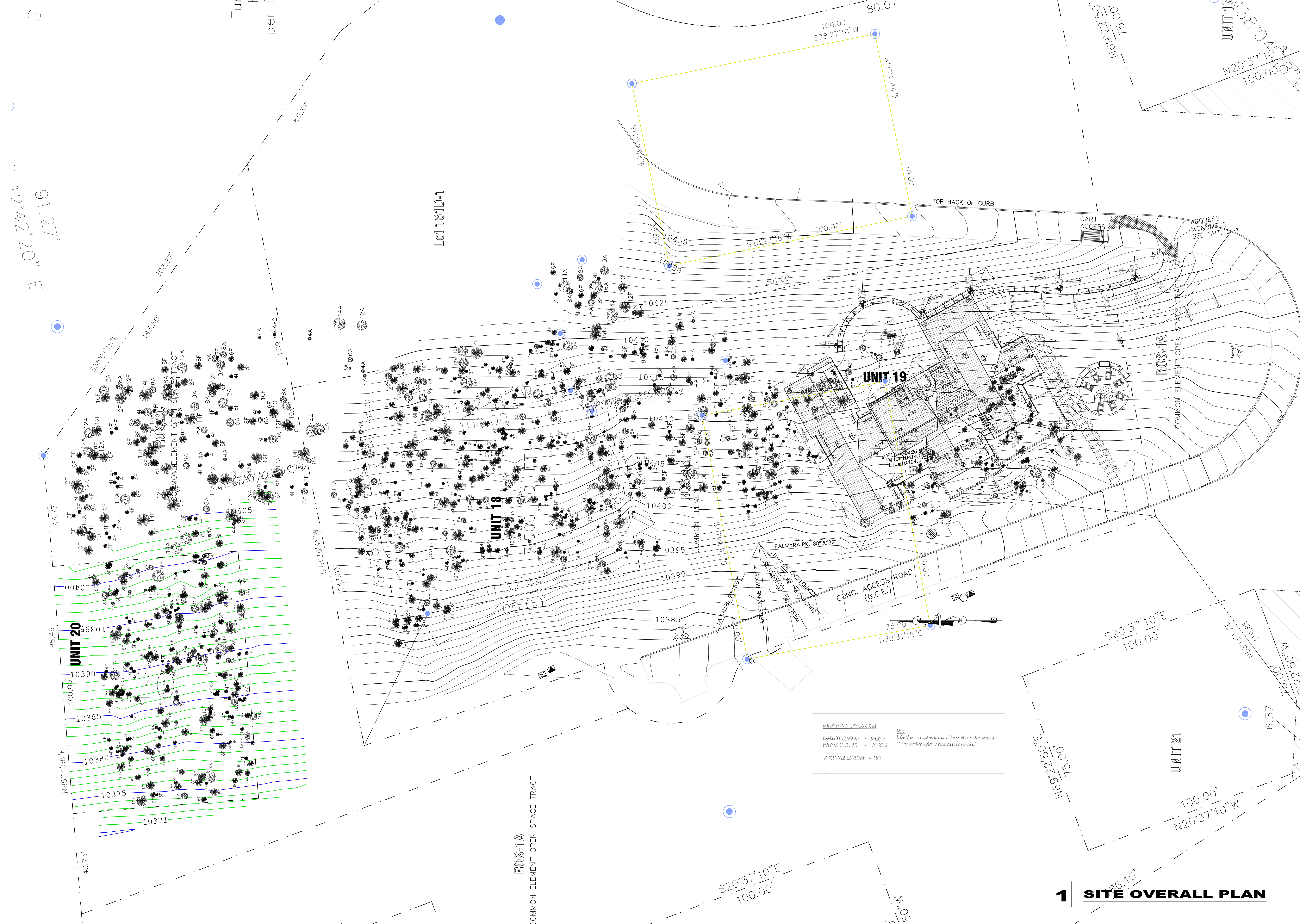

91.27'
19°42'20" E

Turf
per f

Lot 161D-1

ROS-1A
COMMON ELEMENT OPEN SPACE TRACT

BUILDING ENVELOPE COVERAGE
ENVELOPE COVERAGE = 5487 SF
BUILDING ENVELOPE = 7500 SF
PERCENTAGE COVERAGE = 73%

Note:
1. Residence is required to have a fire sprinkler system installed.
2. Fire sprinkler system is required to be monitored.

1 SITE OVERALL PLAN

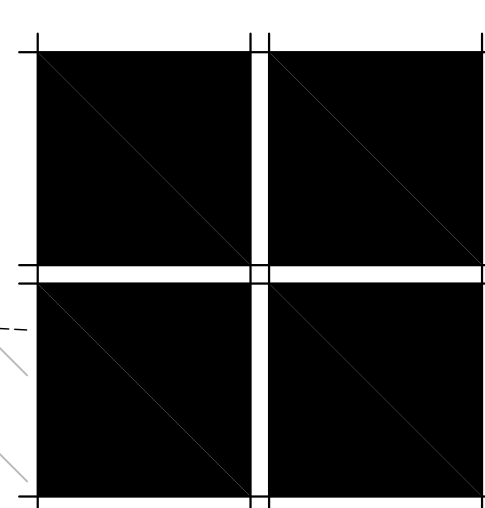

COPYRIGHT
All designs, ideas, arrangements and plans indicated by these drawings and specifications are the property and copyright of the Architect and shall neither be used on any other work nor be used by any other person for any use whatsoever without written permission. Written dimensions shall take precedence over scaled dimensions and shall be verified at the site. Any dimensional discrepancies shall be brought to the attention of the Architect prior to the commencement of the work.

ISSUE LOG

Sketch ORB submittal	12-29-20
----------------------	----------

FILE NAME	
JOB NUMBER	XXX
DRAWN BY	SM
SCALE	1/16" = 1'-0"
SHEET	

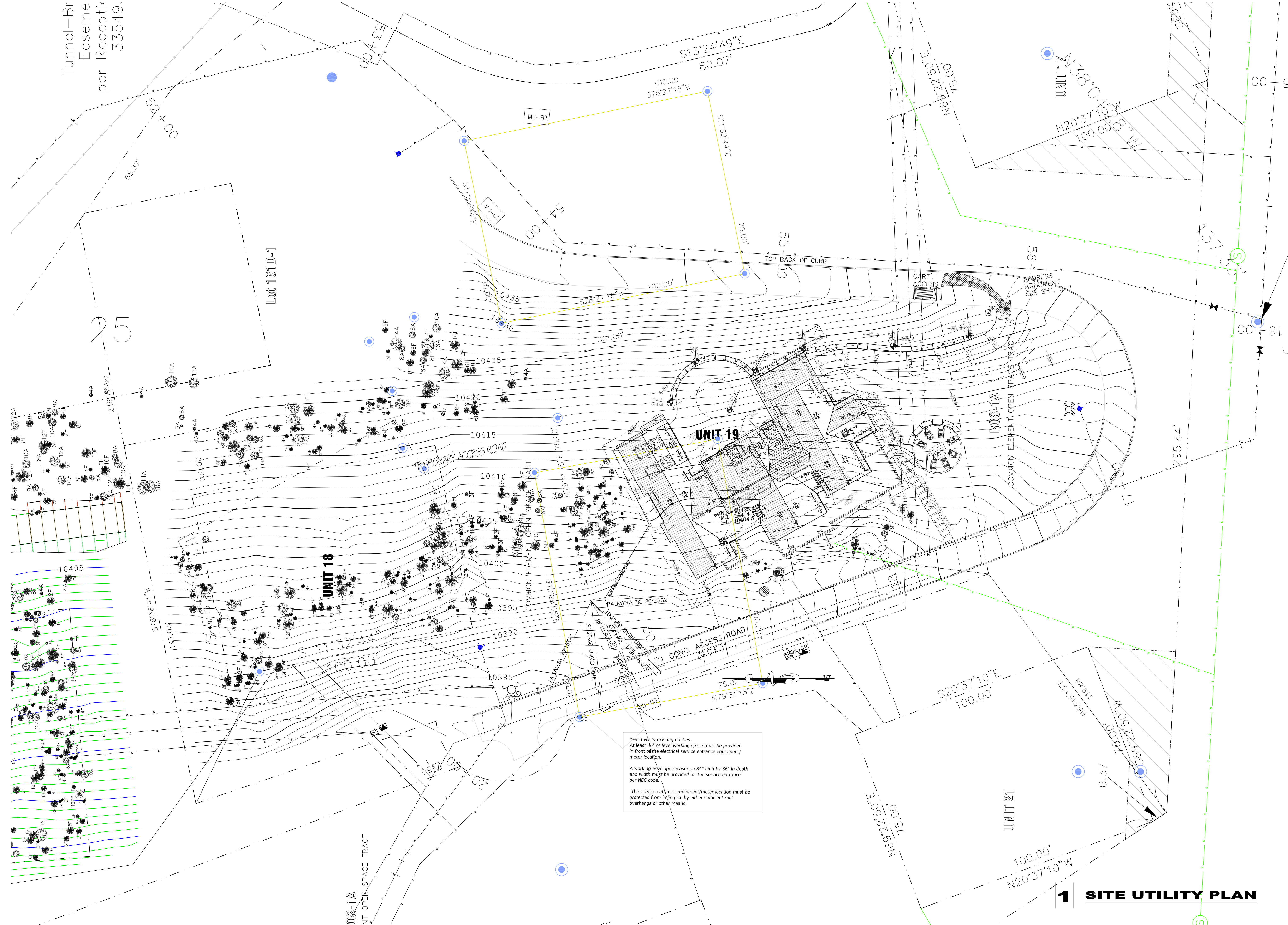

*Field verify existing utilities.
 At least 36" of level working space must be provided in front of the electrical service entrance equipment/meter location.

A working envelope measuring 84" high by 36" in depth and width must be provided for the service entrance per NEC code.

The service entrance equipment/meter location must be protected from falling ice by either sufficient roof overhangs or other means.

Tunnel-Br
 Easeme
 per Receptic
 33549.

Lot 161D-1

UNIT 18

UNIT 19

UNIT 21

1 SITE UTILITY PLAN

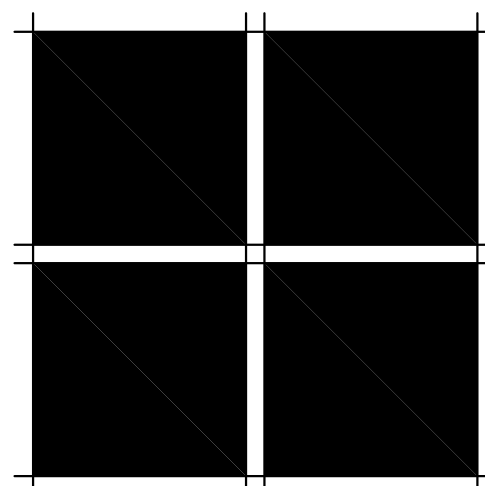

COPYRIGHT
 All designs, ideas, arrangements and plans indicated by these drawings and specifications are the property and copyright of the Architect and shall neither be used on any other work nor be used by any other person for any use whatsoever without written permission. Written dimensions shall take precedence over scaled dimensions and shall be verified at the site. Any dimensional discrepancies shall be brought to the attention of the Architect prior to the commencement of the work.

ISSUE LOG

Sketch	DRB	submit	12-29-20

FILE NAME

JOB NUMBER
XXX

DRAWN BY
SM

SCALE
1/16" = 1'-0"

SHEET

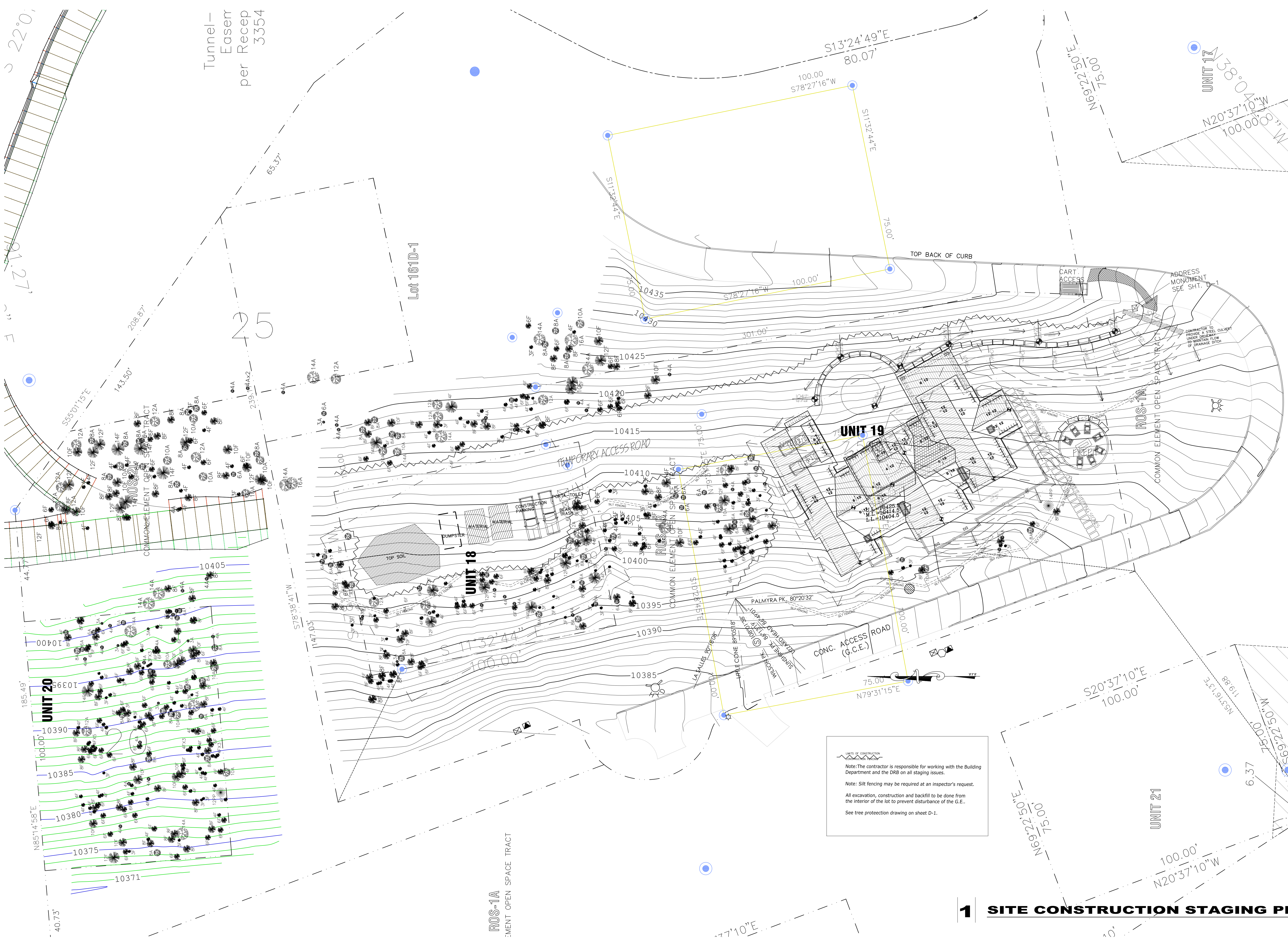

Tunnel—
Easement
Reception
3354

Lot 161D-1

ROS-1A
COMMON ELEMENT OPEN SPACE TRACT

LIMITS OF CONSTRUCTION

Note: The contractor is responsible for working with the Building Department and the DRB on all staging issues.

Note: Silt fencing may be required at an inspector's request.

All excavation, construction and backfill to be done from the interior of the lot to prevent disturbance of the G.E.

See tree protection drawing on sheet D-1.

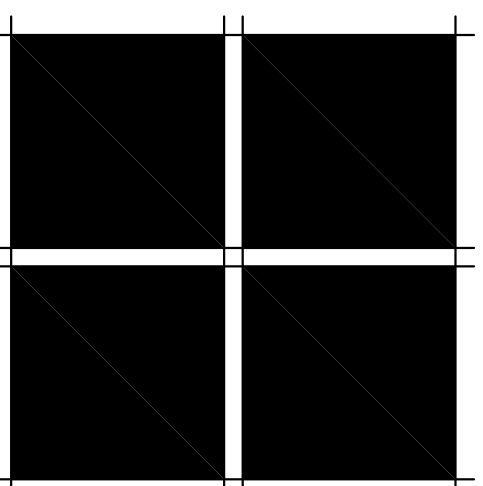

COPYRIGHT
All designs, ideas, arrangements and plans indicated by these drawings and specifications are the property and copyright of the Architect and shall neither be used on any other work nor be used by any other person for any use whatsoever without written permission. Written dimensions shall take precedence over scaled dimensions and shall be verified at the site. Any dimensional discrepancies shall be brought to the attention of the Architect prior to the commencement of the work.

ISSUE LOG	
Sketch DRB submittal	12-29-20
FILE NAME	
JOB NUMBER	
XXX	
DRAWN BY	
SM	
SCALE	
1/16" = 1'-0"	
SHEET	

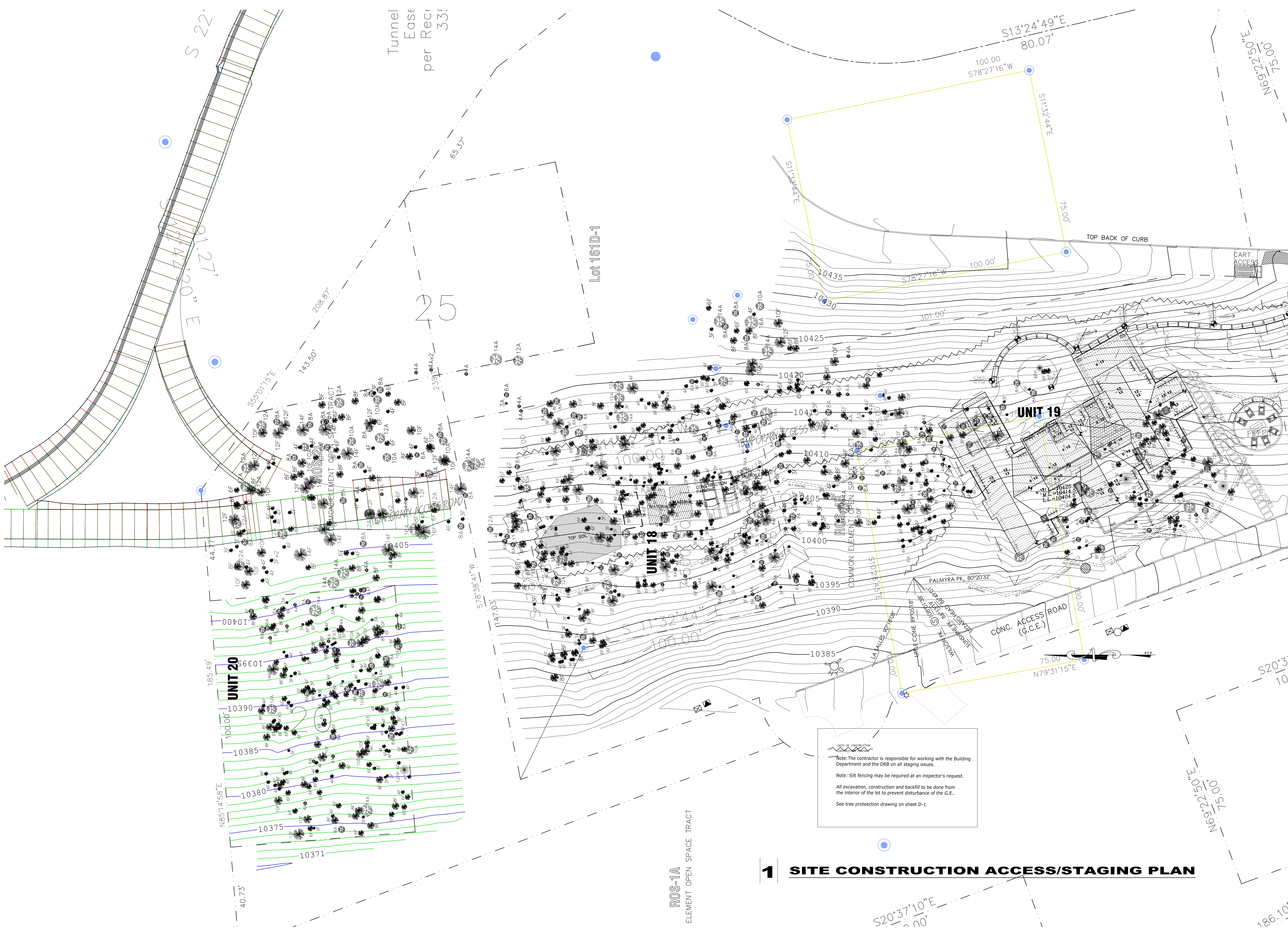

Limits of construction
 Note: The contractor is responsible for working with the Building Department and the DRB on all staging issues.
 Note: Silt fencing may be required at an inspector's request.
 All excavation, construction and backfill to be done from the interior of the lot to prevent disturbance of the G.E.
 See tree protection drawing on sheet D-1.

1 SITE CONSTRUCTION ACCESS/STAGING PLAN

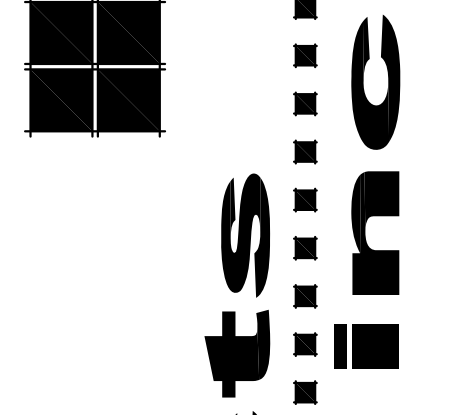

MORTON
architects inc.

LUSK RESIDENCE
Lot 19 THE RIDGE, TOWN OF MOUNTAIN VILLAGE, CO. 81435

CONSTRUCTION STAGING (703) 708-2246

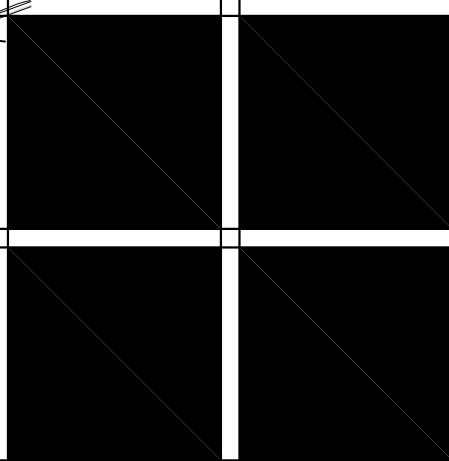

COPYRIGHT
All designs, ideas, arrangements and plans indicated by these drawings and specifications are the property and copyright of the Architect and shall neither be used on any other work nor be used by any other person for any use whatsoever without written permission. Written dimensions shall take precedence over scaled dimensions and shall be verified at the site. Any dimensional discrepancies shall be brought to the attention of the Architect prior to the commencement of the work.

ISSUE LOG	
Sketch DRB submittal	12-29-20
FILE NAME	
JOB NUMBER	
XXX	
DRAWN BY	
SM	
SCALE	
1/16" = 1'-0"	
SHEET	

A-1.2b
OF SHEETS



IRRIGATION LEGEND:

- POINT OF CONNECT.
- VALVE BOX
- RAINBIRD MULTI-ZONE CONTROLLER
- RAINBIRD RAIN SENSING DEVICE
- 1 1/4" PVC SCHEDULE 40
- 80# POLYETHYLENE LATERAL

EMISSION DEVICES

- RAINBIRD POP-UP 1804
- RAINBIRD MAXI-PAN 2045A
- 2.0 GPH XERIBUG (XB-20)
- MAXI-LET BARB STAKE ASSEMBLY
- 1/4" DISTRIBUTION TUBING (D-025)

WATER USAGE TABLE:

CATEGORY II	
(25) SPRUCE TREES	750 G/MO
(26) ASPEN TREES	520 G/MO
(78) SHRUBS	255 G/MO
TOTAL USAGE =	1525 G/MO

NOTES:

1. SITE TO BE REVEGETATED WITHIN 30 DAYS OF CUT.
2. UTILITIES TO BE REVEGETATED WITHIN 2 WEEKS OF CUT.
3. OWNER TO INSURE PROPER NEEZ CONTROL IN ALL NEEZ AREAS.
4. NEWLY SITED AREAS TO BE PROTECTED WITH MULCHES.

NOTE: FINAL IRRIGATION PLAN TO BE SUBMITTED BY IRRIGATION SUBCONTRACTOR PRIOR TO CONSTRUCTION.

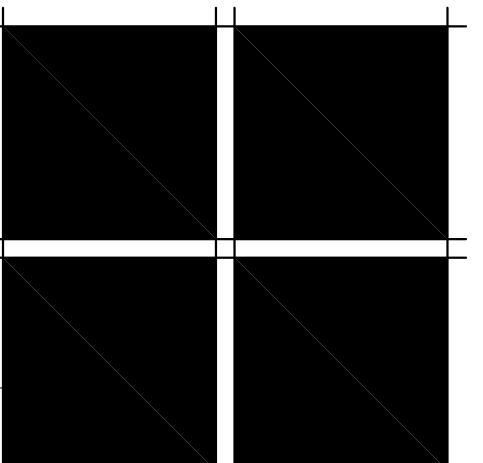

COPYRIGHT
 All designs, ideas, arrangements and plans indicated by these drawings and specifications are the property and copyright of the Architect and shall neither be used on any other work nor be used by any other person for any use whatsoever without written permission. Written dimensions shall take precedence over scaled dimensions and shall be verified at the site. Any dimensional discrepancies shall be brought to the attention of the Architect prior to the commencement of the work.

ISSUE LOG

Issue	Date
Sketch DRB submittal	12-29-20

FILE NAME

JOB NUMBER
XXX

DRAWN BY
SM

SCALE
1/8" = 1'-0"

SHEET



Lighting Legend:
 □ Recessed step light
 * Recessed can light (Versa Star (B-K Lighting))
 ⊕ Wall mounted light (Teka Illumination - T77)
 ** See 8.5x11" specification sheets for details

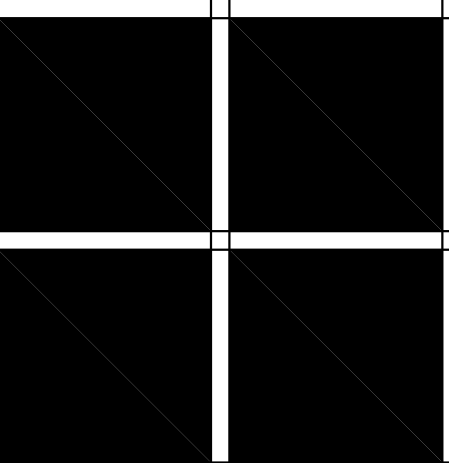

COPYRIGHT
 All designs, ideas, arrangements and plans indicated by these drawings and specifications are the property and copyright of the Architect and shall neither be used on any other work nor be used by any other person for any use whatsoever without written permission. Written dimensions shall take precedence over scaled dimensions and shall be verified at the site. Any dimensional discrepancies shall be brought to the attention of the Architect prior to the commencement of the work.

ISSUE LOG	
Sketch DRB submit	12-29-20

FILE NAME	
JOB NUMBER	XXX
DRAWN BY	SM
SCALE	1/8" = 1'-0"
SHEET	

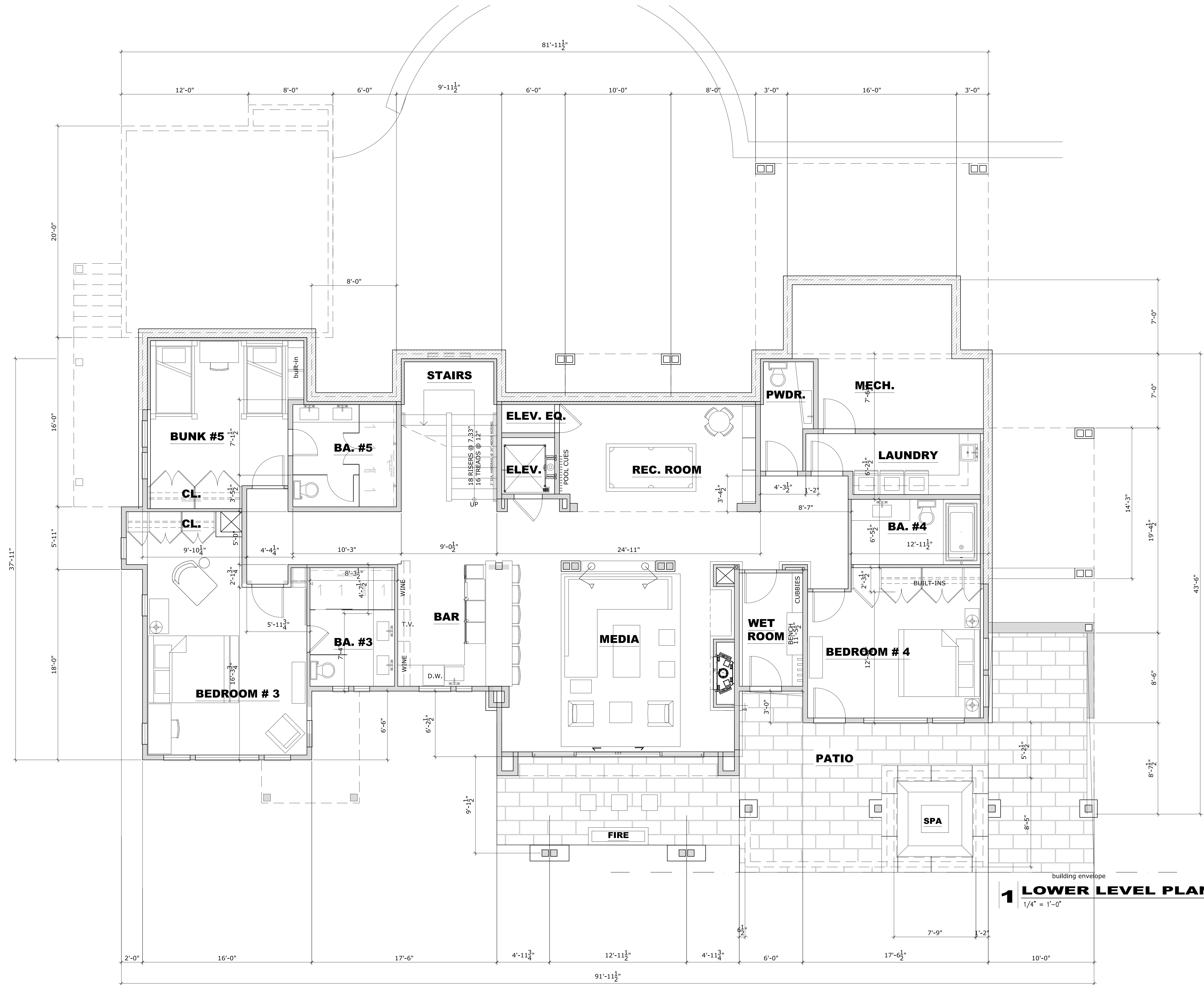

building envelope
1 LOWER LEVEL PLAN
 1/4" = 1'-0"

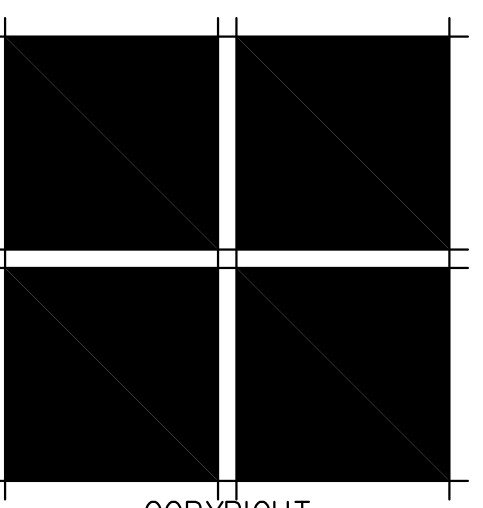

COPYRIGHT
 All designs, ideas, arrangements and plans indicated by these drawings and specifications are the property and copyright of the Architect and shall neither be used on any other work nor be used by any other person for any use whatsoever without written permission. Written dimensions shall take precedence over scaled dimensions and shall be verified at the site. Any dimensional discrepancies shall be brought to the attention of the Architect prior to the commencement of the work.

ISSUE LOG

Sketch DRB submittal	12-28-20
----------------------	----------

FILE NAME	
JOB NUMBER	XXX
DRAWN BY	SM
SCALE	1/4" = 1'-0"
SHEET	

PROJECT SUMMARY - 12.23.20
SINGLE FAMILY DWELLING UNIT - LOT 19

LOWER LIVING	2,692 S.F.
MAIN LIVING	2,820 S.F.
UPPER LIVING	1,225 S.F.
TOTAL LIVING	6,737 S.F.
GARAGE	416 S.F.
MECH	128 S.F.
TOTAL	544 S.F.
TOTAL BUILDABLE	7,281 S.F.
LOWER LEVEL PATIO	700 S.F.
MAIN LEVEL DECKS	800 S.F.
UPPER LEVEL PATIO	140 S.F.
TOTAL EXT. SURFACE	1,731 S.F.
TOTAL CART COURT	1,760 S.F.

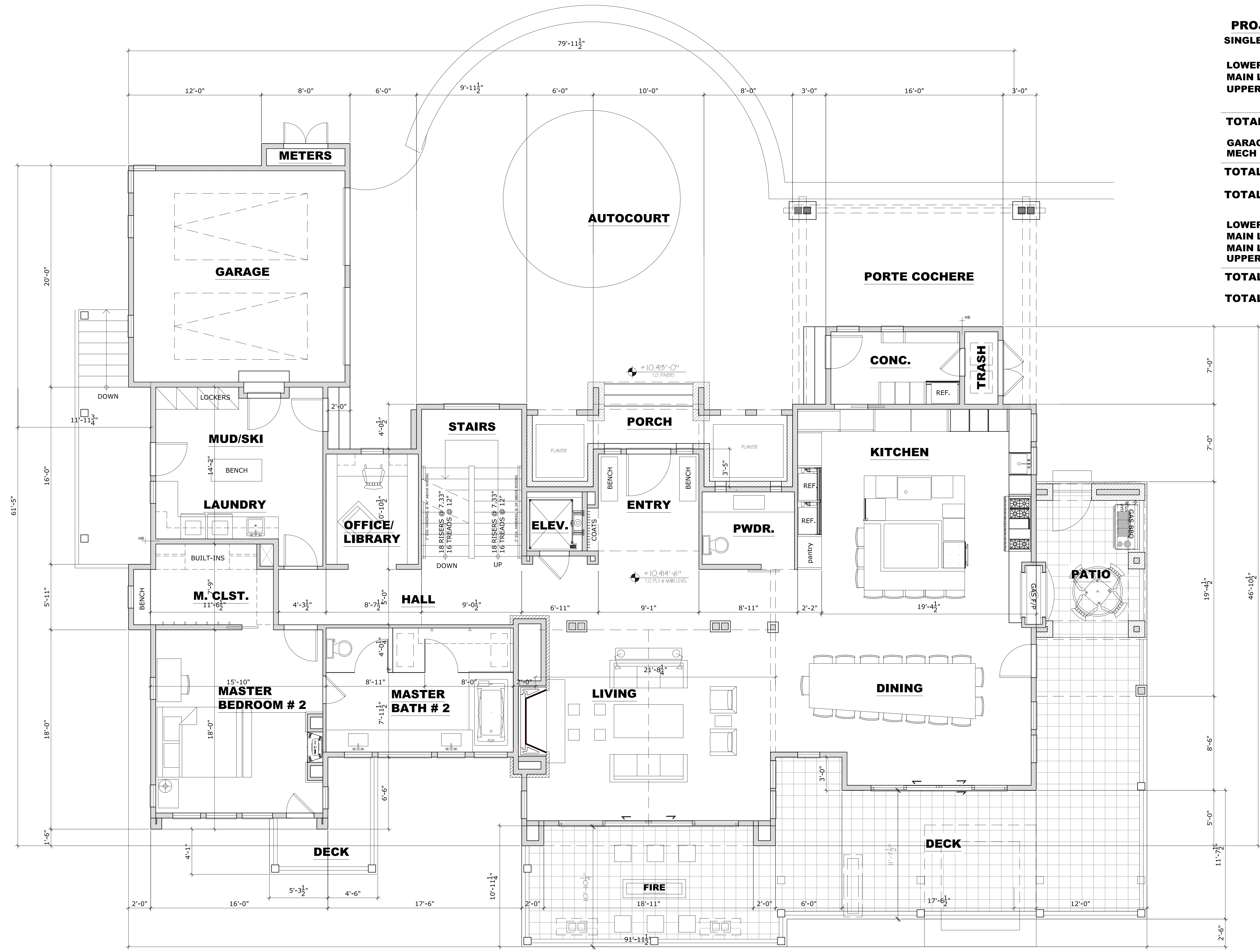

NOTE
 RESIDENCE IS REQUIRED TO BE FIRE SPRINKLERED AND
 HAVE A MONITORING SYSTEM

2 MAIN LEVEL PLAN
 1/4" = 1'-0"

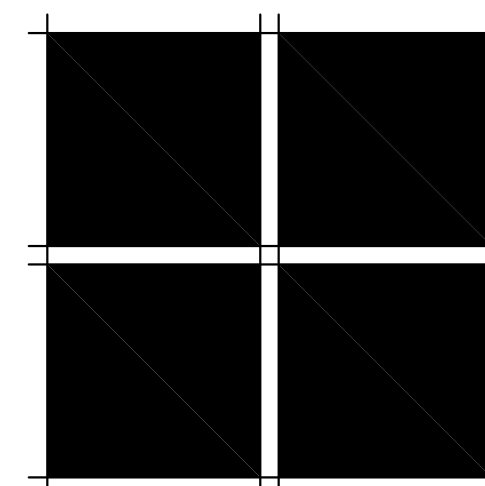

COPYRIGHT
 All designs, ideas, arrangements and plans indicated by these drawings and specifications are the property and copyright of the Architect and shall neither be used on any other work nor be used by any other person for any use whatsoever without written permission. Written dimensions shall take precedence over scaled dimensions and shall be verified at the site. Any dimensional discrepancies shall be brought to the attention of the Architect prior to the commencement of the work.

ISSUE LOG

Sketch DRB submittal	12-29-20
FILE NAME	
JOB NUMBER	XXX
DRAWN BY	SM
SCALE	1/4" = 1'-0"
SHEET	

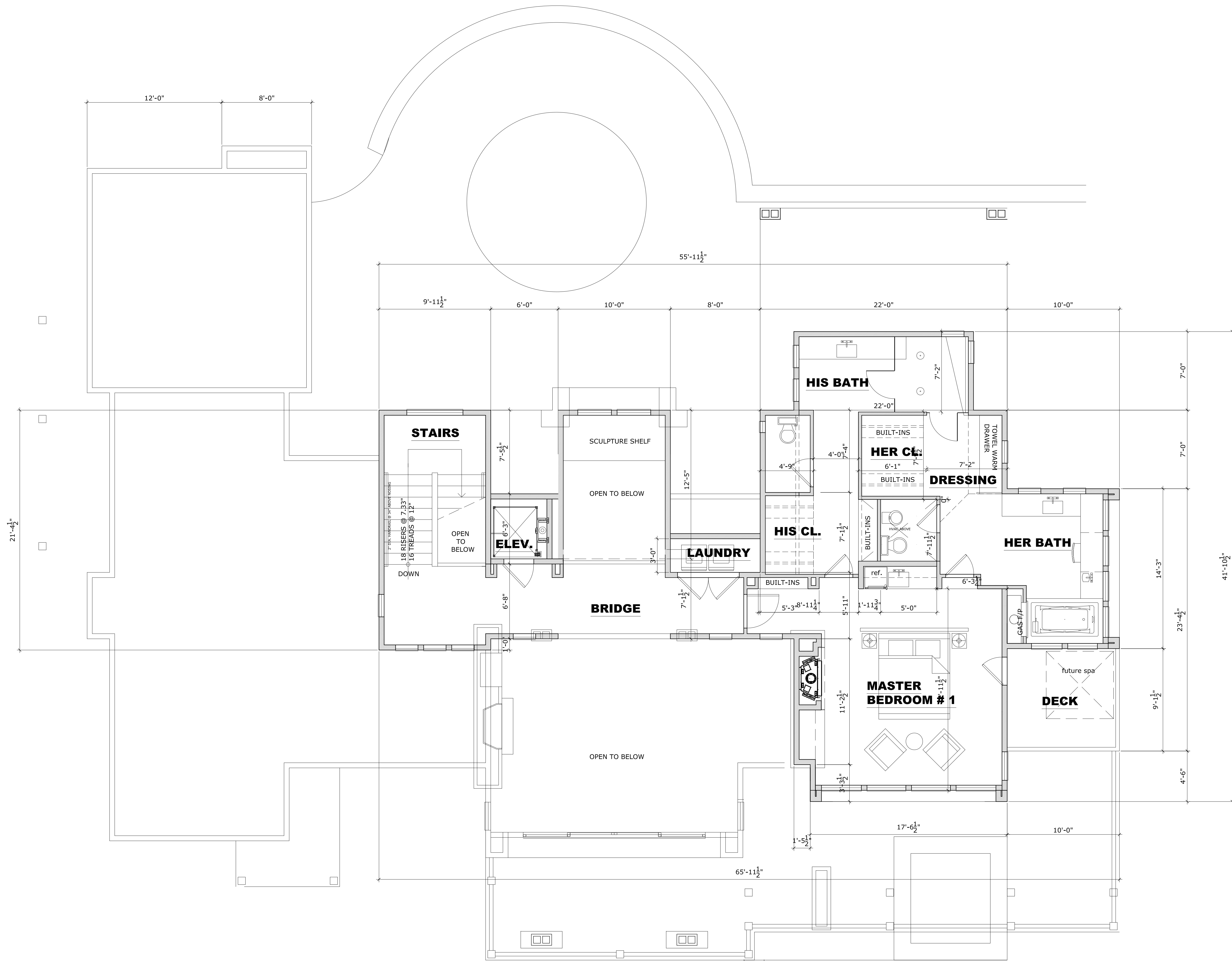

3 UPPER LEVEL PLAN
1/4" = 1'-0"

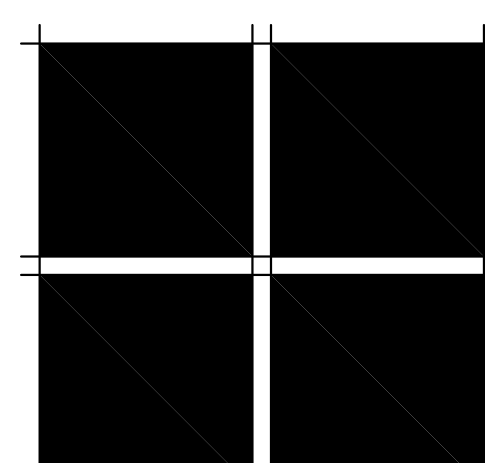

COPYRIGHT
All designs, ideas, arrangements and plans indicated by these drawings and specifications are the property and copyright of the Architect and shall neither be used on any other work nor be used by any other person for any use whatsoever without written permission. Written dimensions shall take precedence over scaled dimensions and shall be verified at the site. Any dimensional discrepancies shall be brought to the attention of the Architect prior to the commencement of the work.

ISSUE LOG	
Sketch DBP submittal	12-29-20
FILE NAME	
JOB NUMBER	
XXX	
DRAWN BY	
SM	
SCALE	
1/4" = 1'-0"	
SHEET	

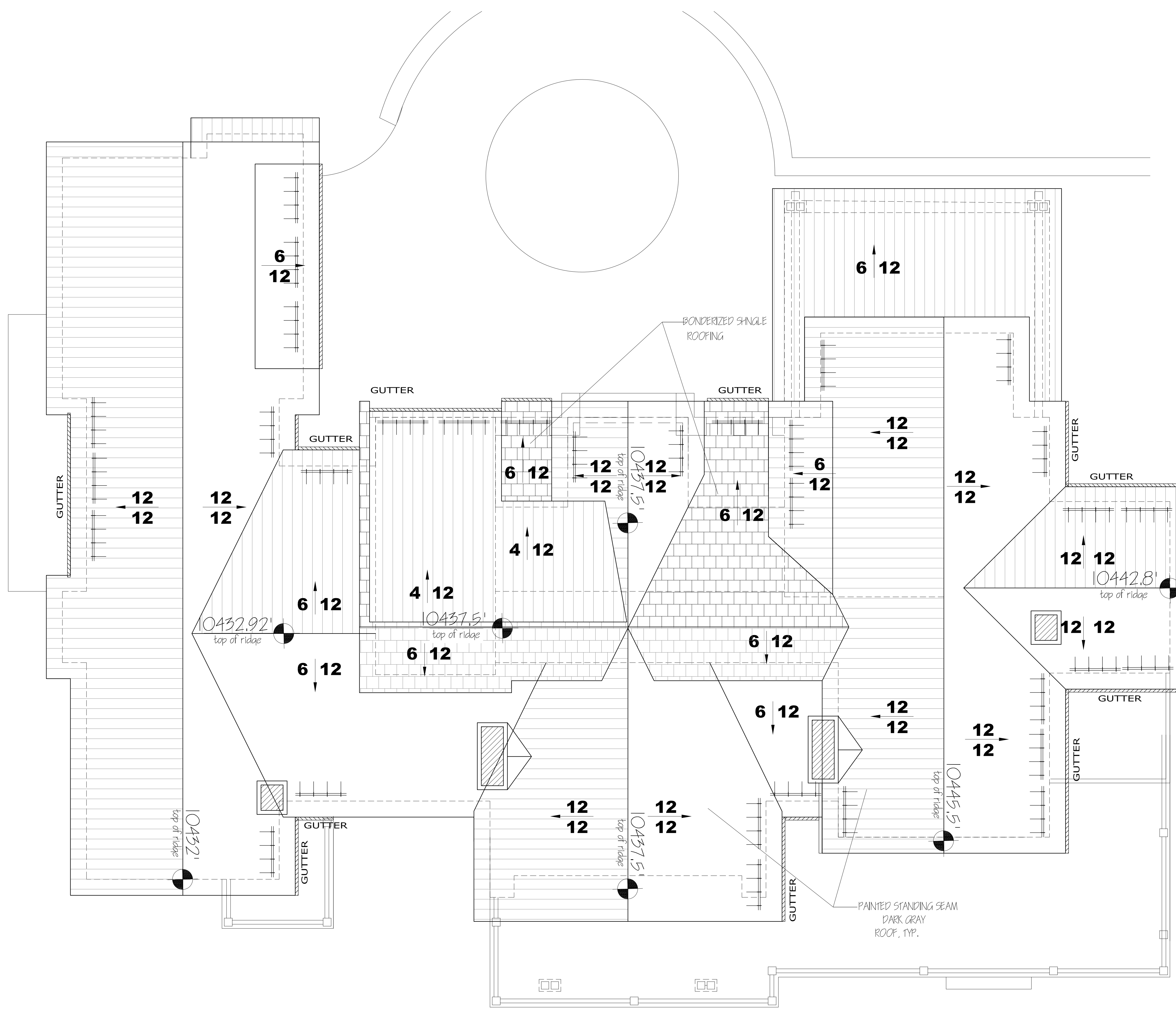

5 ROOF PLAN
1/4" = 1'-0"

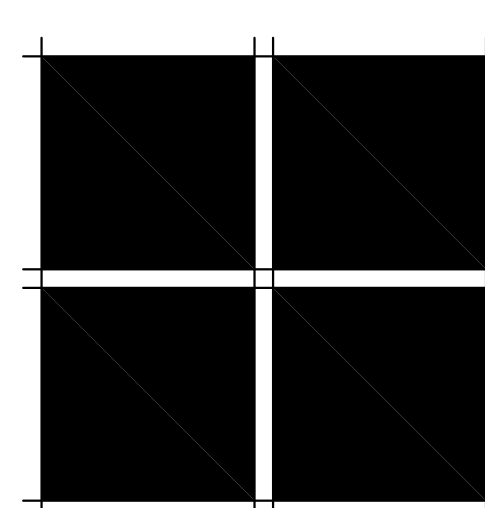

COPYRIGHT
All designs, ideas, arrangements and plans indicated by these drawings and specifications are the property and copyright of the Architect and shall neither be used on any other work nor be used by any other person for any use whatsoever without written permission. Written dimensions shall take precedence over scaled dimensions and shall be verified at the site. Any dimensional discrepancies shall be brought to the attention of the Architect prior to the commencement of the work.

ISSUE LOG	
Sketch DRB submittal	12-29-20
FILE NAME	
JOB NUMBER XXX	
DRAWN BY SM	
SCALE 1/4" = 1'-0"	
SHEET	



WEST ELEVATION
1/4" = 1'-0"



EAST ELEVATION
1/4" = 1'-0"

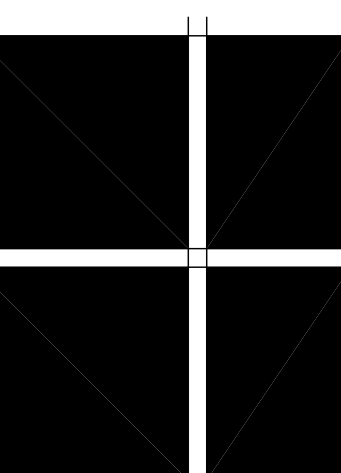

COPYRIGHT
All designs, ideas, arrangements, plans and specifications are the property and copyright of the Architect. No part of this work shall be used or reproduced in any form without the written permission of the Architect. Written dimensions shall take precedence over scaled dimensions and shall be verified at the site. Any dimensional discrepancies are brought to the attention of the Architect prior to the commencement of the work.

ISSUE LOG

Sketch	DRB	submital	12-29-21

FILE NAME

JOB NUMBER
XXX

DRAWN BY
SM

SCALE

SHEET 1/4" = 1'-0"

A-3.1

OF SHEETS

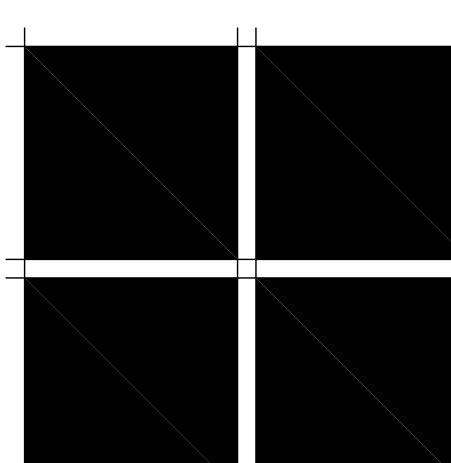

COPYRIGHT
All designs, ideas, arrangements and plans indicated by these drawings and specifications are the property and copyright of the Architect and shall neither be used on any other work nor be used by any other person for any use whatsoever without written permission. Written dimensions shall take precedence over scaled dimensions and shall be verified at the site. Any dimensional discrepancies shall be brought to the attention of the Architect prior to the commencement of the work.

ISSUE LOG

Sketch DBS submitter	12-29-20
----------------------	----------

FILE NAME

JOB NUMBER
XXX

DRAWN BY
SM

SCALE

SHEET
A-3.1
OF SHEETS

EXTERIOR ELEVATIONS
221 S. PINE ST., PO BOX 3561 TELLURIDE, CO. 81435
(970) 708-2246

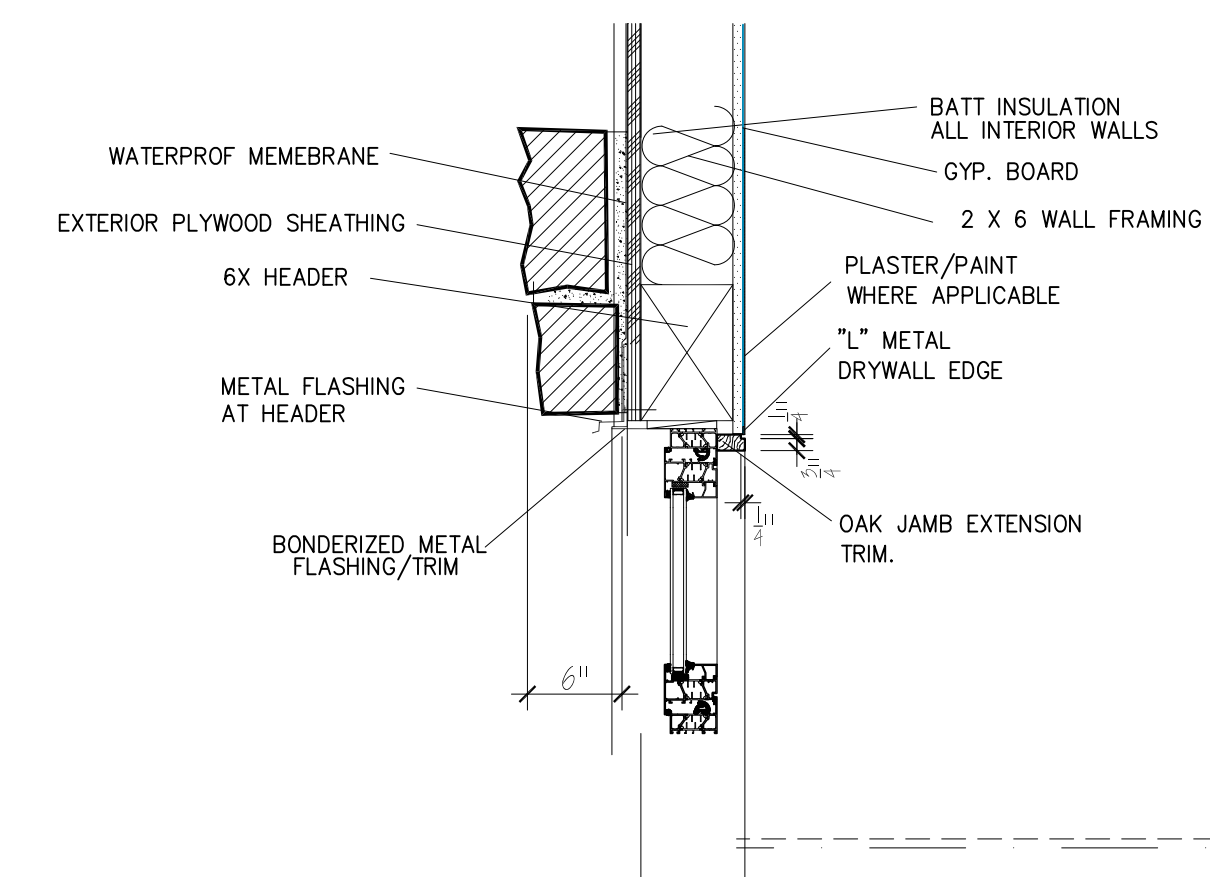

TYPICAL WINDOW IN STONE DETAIL

MAX. AVERAGE HT. (PER ELEVATION)
 $\frac{149'-11''}{6} = 24'-11\frac{3}{4}''$

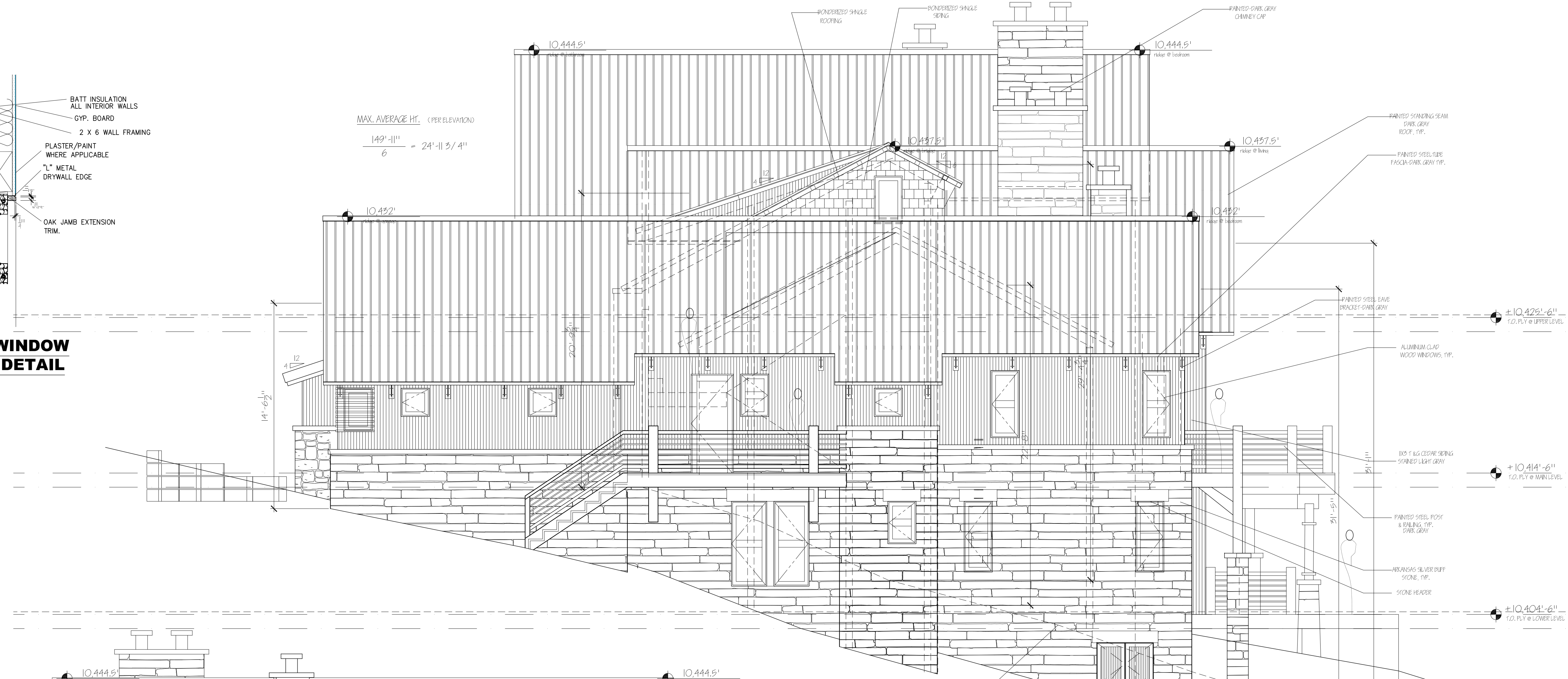

NORTH ELEVATION
1/4" = 1'-0"

MAX. AVERAGE HT. (PER ELEVATION)
 $\frac{128'-5''}{6} = 25'-8''$

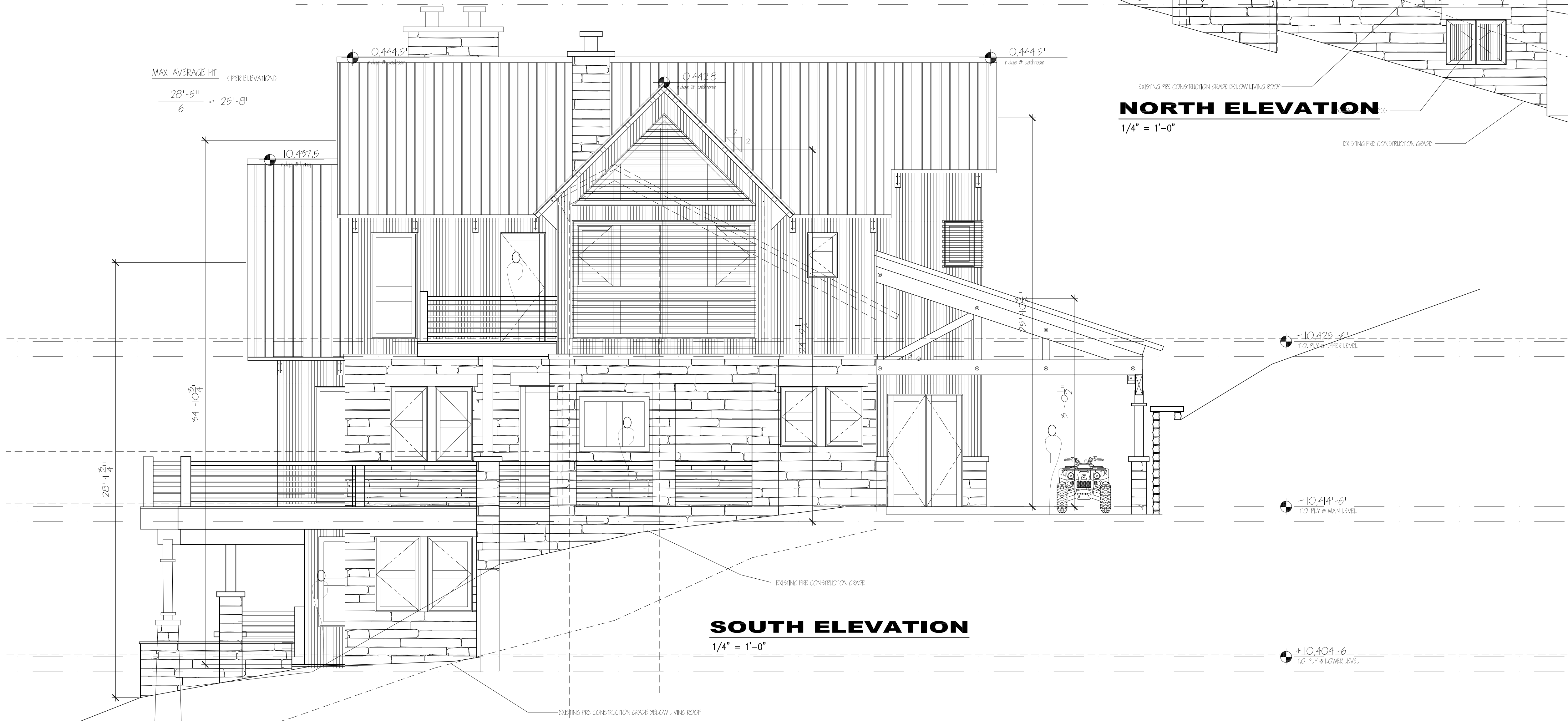

SOUTH ELEVATION
1/4" = 1'-0"

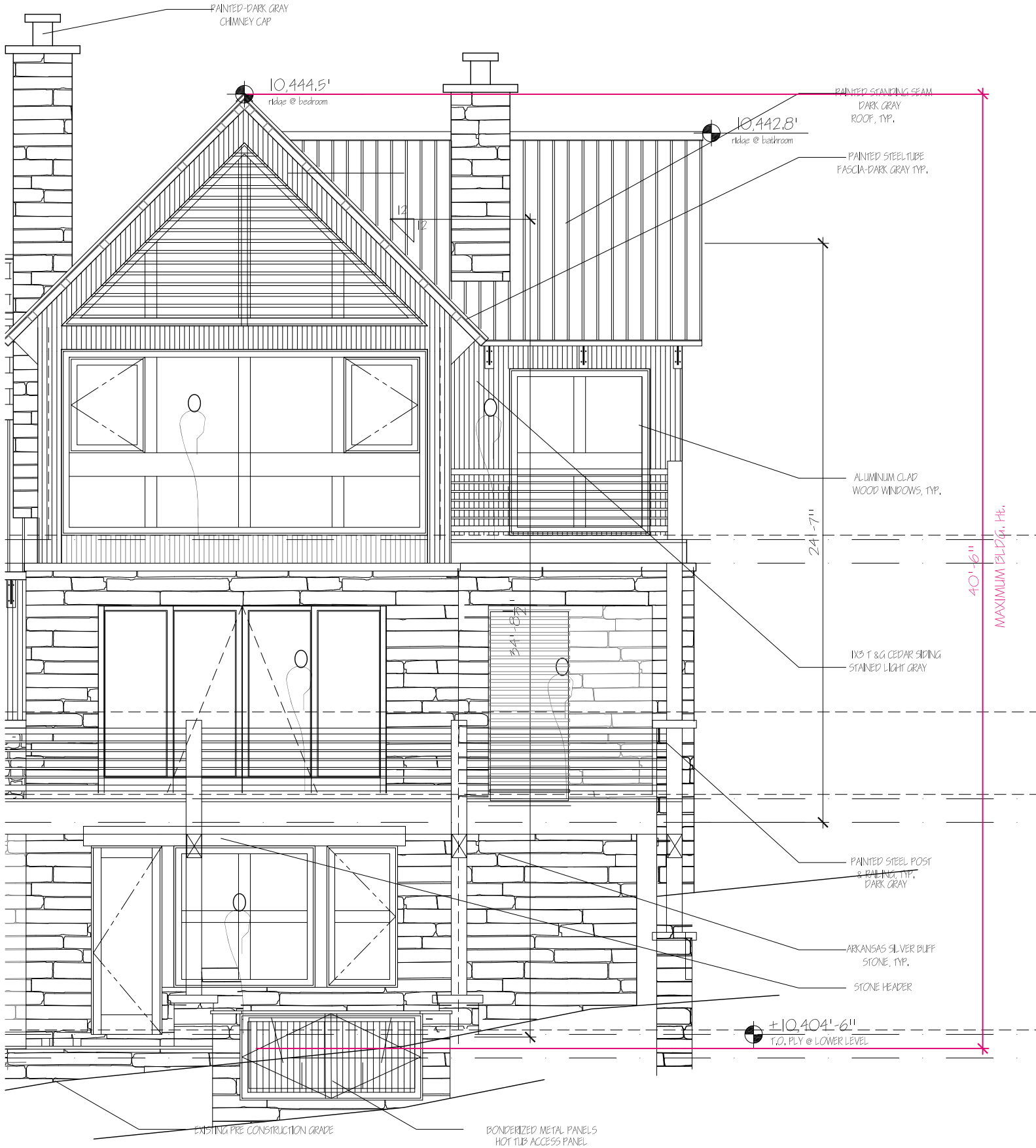

PAINTED-DARK GRAY
CHIMNEY CAP

10,444.5'
ridge @ bedroom

10,442.8'
ridge @ bathroom

PAINTED STANDING SEAM
DARK GRAY
ROOF, TYP.

PAINTED STEEL TUBE
FASCIA-DARK GRAY TYP.

12
12

24'-7"

ALUMINUM CLAD
WOOD WINDOWS, TYP.

40'-6"
MAXIMUM BLDG. Ht.

1/2" T & G CEDAR SIDING
STAINED LIGHT GRAY

PAINTED STEEL POST
& RAILING, TYP.
DARK GRAY

ARKANSAS SILVER BLUFF
STONE, TYP.

STONE HEADER

±10,404'-6"
F.O. PLY @ LOWER LEVEL

EXISTING PRE CONSTRUCTION GRADE

BONDERIZED METAL PANELS
HOT TUB ACCESS PANEL



WEST ELEVATION
1/8" = 1'-0"



SOUTH ELEVATION
1/8" = 1'-0"



EAST ELEVATION
1/8" = 1'-0"

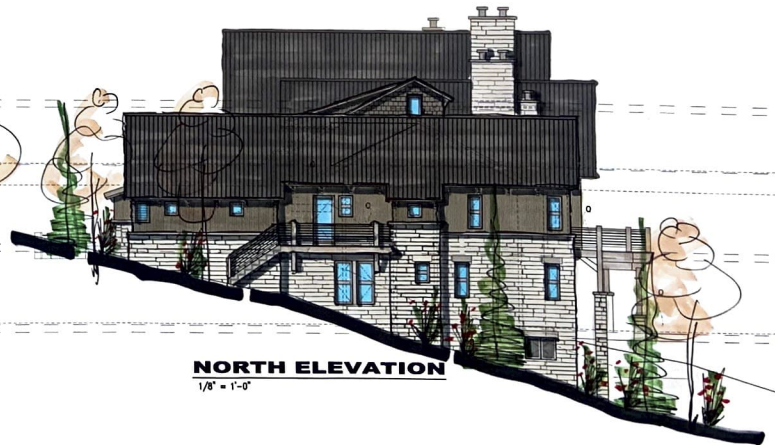

NORTH ELEVATION
1/8" = 1'-0"

COPYRIGHT
All design, ideas, arrangements, plans, elevations, etc. are the property and specifications of the Architect and shall not be used or reproduced in any form without the written permission of the Architect. Written dimensions shall take precedence over scaled dimensions and shall be verified at the site. Any dimensional discrepancies shall be brought to the attention of the Architect prior to the commencement of the work.

ISSUE LOG	
FILE NAME	
JOB NUMBER	XXX
DRAWN BY	SM
SCALE	
SHEET	



EXTERIOR WALL MATERIALS

□	STONE AREA	1248
△	WOOD AREA	578
○	ACCENT AREA	92
○	PENETRATION AREA	1151
TOTAL WALL AREA		3049 SF.

WEST ELEVATION
 1/8" = 1'-0"

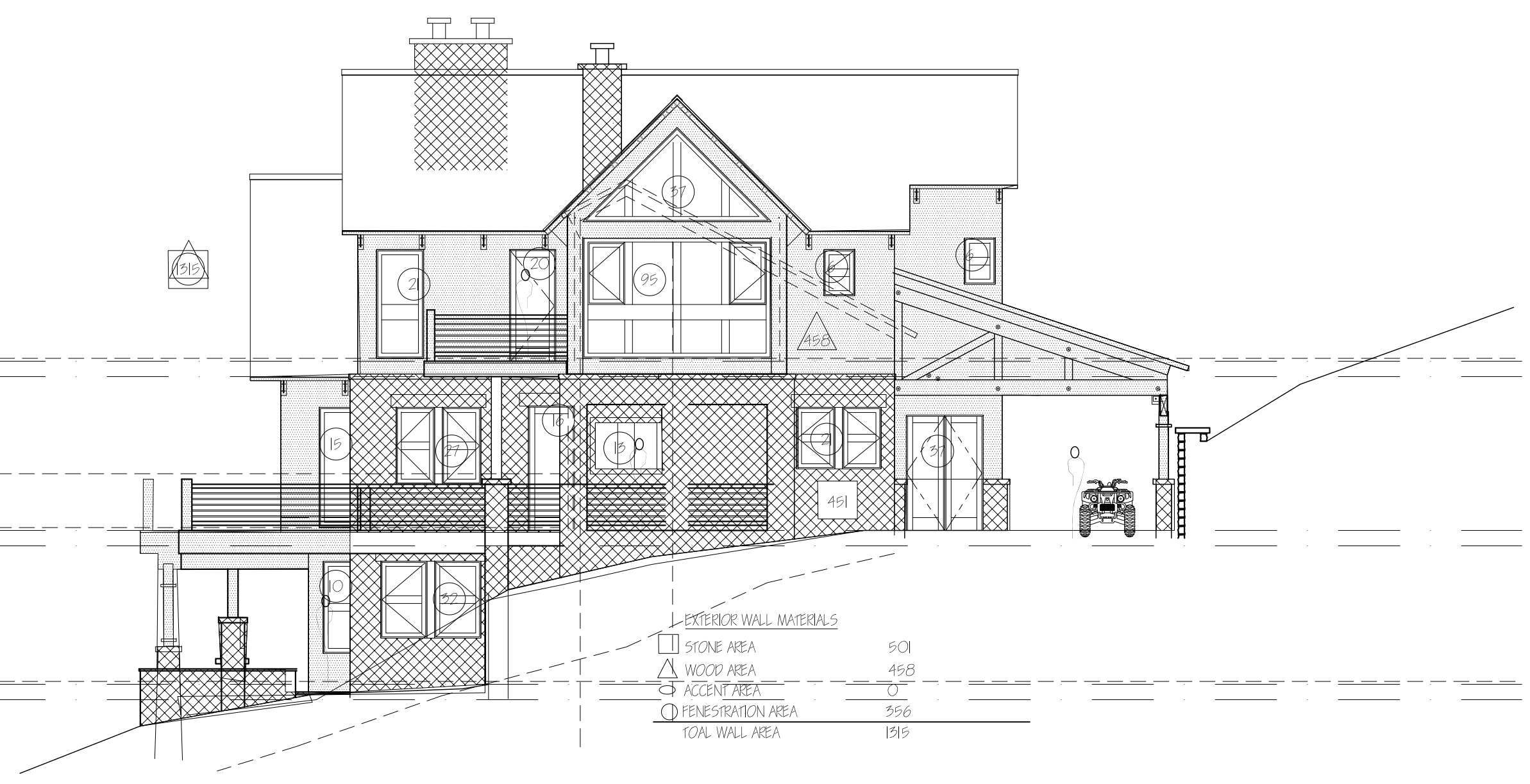

EXTERIOR WALL MATERIALS

□	STONE AREA	901
△	WOOD AREA	458
○	ACCENT AREA	107
○	PENETRATION AREA	596
TOTAL WALL AREA		1962

SOUTH ELEVATION
 1/8" = 1'-0"

TOTAL EXTERIOR WALL MATERIALS

□	STONE AREA	2934	40 %
△	WOOD AREA	2143	29.5 %
○	ACCENT AREA	225	3.5 %
○	PENETRATION AREA	1952	27 %
TOTAL WALL AREA		7254	



EXTERIOR WALL MATERIALS

□	STONE AREA	425
△	WOOD AREA	738
○	ACCENT AREA	105
○	PENETRATION AREA	541
TOTAL WALL AREA		1809

EAST ELEVATION
 1/8" = 1'-0"

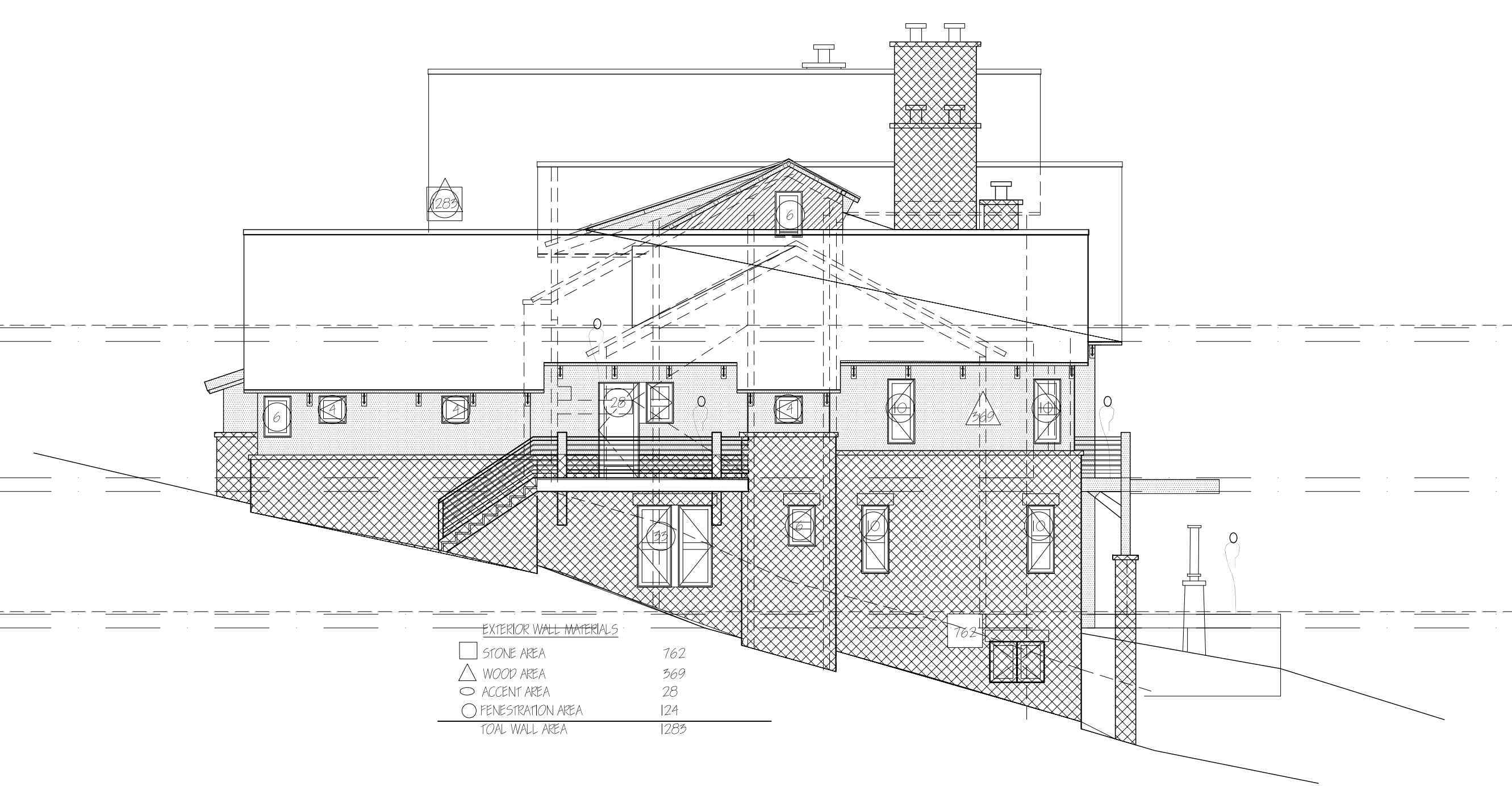

EXTERIOR WALL MATERIALS

□	STONE AREA	762
△	WOOD AREA	569
○	ACCENT AREA	28
○	PENETRATION AREA	124
TOTAL WALL AREA		1283

NORTH ELEVATION
 1/8" = 1'-0"

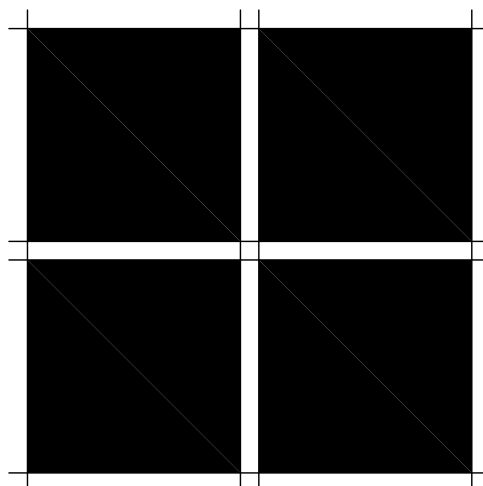

COPYRIGHT
 All designs, ideas, arrangements and plans indicated by these drawings and specifications are the property and copyright of the Architect and shall neither be used on any other work nor be used by any other person for any use whatsoever without written permission. Written dimensions shall take precedence over scaled dimensions and shall be verified at the site. Any dimensional discrepancies shall be brought to the attention of the Architect prior to the commencement of the work.

ISSUE LOG

Sketch DBL submittal	12-29-20
FILE NAME	
JOB NUMBER	
XXX	
DRAWN BY	
SM	
SCALE	
SHEET	
1/8" = 1'-0"	



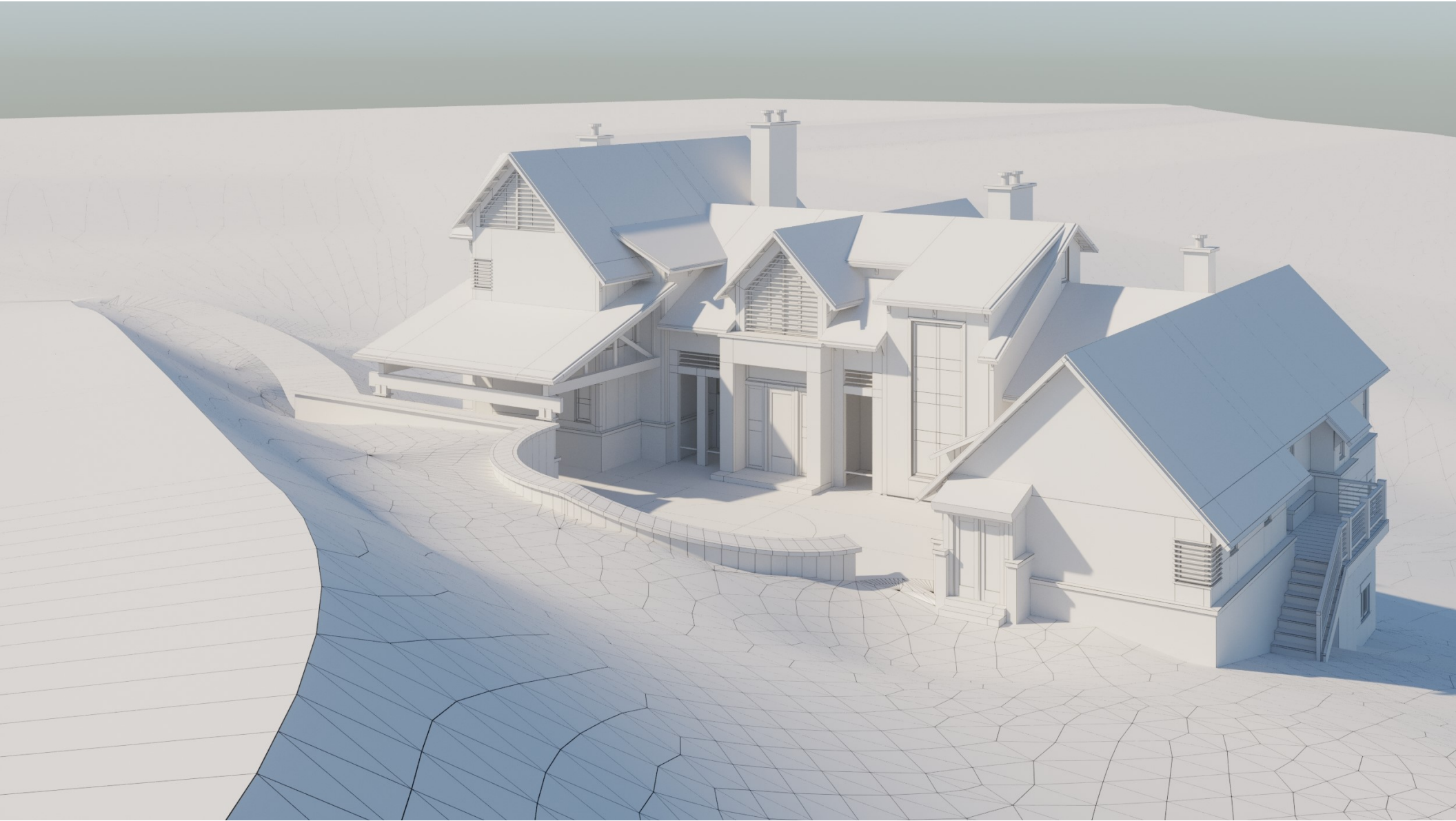

John A. Miller

From: Kaye Simonson <kayes@sanmiguelcountyco.gov>
Sent: Tuesday, January 26, 2021 11:55 AM
To: John A. Miller
Cc: Ron Quarles; Amy Markwell; kgeiger@telluride-co.gov; Michelle Haynes; Amy Ward; pwisor; chris@alpineplanningllc.com
Subject: Re: Unit 17 - Ridge Club, Courtesy Referral

John,

San Miguel County has no objections to the request to waive story poles for the proposed project at Unit 17 - The Ridge. The proposed maximum roof elevation is approximately 10,480', while the ridge elevation is about 10,575. The site is not visible from any locations identified in the Settlement Agreement. If you have any questions, please let me know. Thanks.

Kaye

On Mon, Jan 25, 2021 at 7:07 PM John A. Miller <JohnMiller@mtnvillage.org> wrote:

Evening everyone –

I am just following up on the below email regarding Unit 17 at the ridge. Please note the deadline for comments.

Thanks and hope you're all doing well,

J

John A Miller III, CFM

Senior Planner

Planning & Development Services

Town of Mountain Village

455 Mountain Village Blvd, Suite A

Mountain Village, CO 81435

O :: 970.369.8203

C :: 970.417.1789



Building and Planning Department
Ron Quarles, Director

MEMORANDUM

TO: John A Miller III, Senior Planner, Town of Mountain Village

FROM: Phil Taylor, Senior Planner, Town of Telluride

DATE: January 26th, 2021

Address: 6 Tunnel Lane

SUBJECT: Initial Architectural Site Review (IASR) and story pole waiver request for Unit 17- The Ridge, Lot 161D-1.

The Planning and Building Department has the following comments on this case:

1. The Town of Telluride does not object to waiving the requirement to erect story poles on Lot 161D-1. The Town has no further comments on this request.
2. If the proposed detached condominium residence will not be visible from the Town of Telluride or the Valley Floor, the Town has no comments regarding the initial plans submitted by the applicant, Alpine Planning, LLC.

Thank you,

Philip Taylor, AICP

John A. Miller

From: Jim Boeckel <jim@telluridefire.com>
Sent: Tuesday, January 19, 2021 9:02 AM
To: John A. Miller
Subject: Re: Class 3 Referral - New Detached Condo Home @ Unit 19, the Ridge

John,

This residence is required to have a fire sprinkler system installed and the sprinkler system shall be monitored.

On Mon, Jan 18, 2021 at 12:02 PM John A. Miller <JohnMiller@mtnvillage.org> wrote:

Good Afternoon All,

Below you will find a link to a proposed new home to be located at Lot 161D1-19, San Sophia Ridge. This home was originally approved and construction began on a foundation which was ultimately abandoned. The new design incorporates the previous foundation and modifies slightly.

Link:

<https://mtnvillage.exavault.com/files/SHARED%20FOLDER%20FOR%20PLANNERS%20FILES%20BACK%20TO%20CLEINT/161D1-19%20Ridge%20Referral%20to%20SMC%2001.18.21>

John A. Miller

From: Jim Loebe
Sent: Tuesday, January 19, 2021 11:44 AM
To: John A. Miller
Subject: RE: Class 3 Referral - New Detached Condo Home @ Unit 17, the Ridge

Hey John,

I'm not sure what their proposed construction equipment access will be for this site, but we'll need to sit down with the contractor before they break ground to put a communication plan together. Same comments for the other referral.

Thank you,

Jim Loebe
Transit Director and Director of Parks and Recreation
Town of Mountain Village
O::970.369.8300
M::970.729.3434

[Website](#) | [Facebook](#) | [Twitter](#) | [Instagram](#) | [Email Signup](#)

For information about The Town of Mountain Village's response to COVID-19 (Coronavirus), please visit townofmountainvillage.com/coronavirus/

Si Usted necesita comunicarse conmigo y necesita servicio de traducción al español, simplemente háganoslo saber y podemos proporcionar tal servicio.

From: John A. Miller <JohnMiller@mtnvillage.org>
Sent: Monday, January 18, 2021 11:54 AM
To: Finn KJome <FKJome@mtnvillage.org>; Steven LeHane <SLeHane@mtnvillage.org>; Jim Loebe <JLoebe@mtnvillage.org>; Chris Broady <CBroady@mtnvillage.org>; jim.telfire@montrose.net; jeremy@smpa.com; brien.gardner@blackhillscorp.com; kirby.bryant@centurylink.com; Forward jim.telluridefire.com <jim@telluridefire.com>
Cc: JD Wise <JWise@mtnvillage.org>
Subject: Class 3 Referral - New Detached Condo Home @ Unit 17, the Ridge

Good Afternoon All,

Below you will find a link to a proposed new home to be located at Lot 161D1-17, San Sophia Ridge. This lot is shown below and located directly below the existing home under construction at 7 Tunnel Lane. This project could be further complicated by the future development of Unit 19 which is directly off-screen of the image and shown in red dots – you will receive a separate referral for 19 shortly.

Link:
<https://mtnvillage.exavault.com/p/SHARED%20FOLDER%20FOR%20PLANNERS%20FILES%20BACK%20TO%20CLEINT/Lot%20161D1-17%20Ridge%20Referral%20to%20SMC>

John A. Miller

From: Finn KJome
Sent: Tuesday, January 19, 2021 2:08 PM
To: John A. Miller
Subject: RE: Class 3 Referral - New Detached Condo Home @ Unit 17, the Ridge

John,
All these lots have existing service lines for water and sewer. Make a comment to field verify existing utilities.
Thanks Finn

From: John A. Miller <JohnMiller@mtnvillage.org>
Sent: Monday, January 18, 2021 11:54 AM
To: Finn KJome <FKJome@mtnvillage.org>; Steven LeHane <SLeHane@mtnvillage.org>; Jim Loebe <JLoebe@mtnvillage.org>; Chris Broady <CBroady@mtnvillage.org>; jim.telfire@montrose.net; jeremy@smpa.com; brien.gardner@blackhillscorp.com; kirby.bryant@centurylink.com; Forward jim.telluridefire.com <jim@telluridefire.com>
Cc: JD Wise <JWise@mtnvillage.org>
Subject: Class 3 Referral - New Detached Condo Home @ Unit 17, the Ridge

Good Afternoon All,
Below you will find a link to a proposed new home to be located at Lot 161D1-17, San Sophia Ridge. This lot is shown below and located directly below the existing home under construction at 7 Tunnel Lane. This project could be further complicated by the future development of Unit 19 which is directly off-screen of the image and shown in red dots – you will receive a separate referral for 19 shortly.

Link:
<https://mtnvillage.exavault.com/p/SHARED%20FOLDER%20FOR%20PLANNERS%20FILES%20BACK%20TO%20CLEINT/Lot%20161D1-17%20Ridge%20Referral%20to%20SMC>



AGENDA ITEM 11
PLANNING & DEVELOPMENT SERVICE
PLANNING DIVISION
455 Mountain Village Blvd.
Mountain Village, CO 81435
(970) 728-1392

TO: Mountain Village Design Review Board

FROM: Amy Ward, Planner

FOR: Design Review Board Public Hearing; March 4, 2021

DATE: February 23, 2021

RE: Staff Memo – Initial Architecture and Site Review (IASR) Lot 167, Unit 3, 162 San Joaquin Rd.

APPLICATION OVERVIEW: New Single-Family Home on Lot 167, Unit 3

PROJECT GEOGRAPHY

Legal Description: AIRSPACE UNIT 3, MOUNTAIN VIEW ESTATES, TOWN OF MOUNTAIN VILLAGE, SAN MIGUEL COUNTY, ACCORDING TO THE MAP RECORDED NOVEMBER 28, 2005.

Address: 162 San Joaquin Rd., Unit 3

Applicant/Agent: Kristine Perpar, Shift Architects

Owner: BARILOCHE, LLC, A DELAWARE LIMITED LIABILITY COMPANY

Zoning: Single-Family Common Interest Community (SFCI)

Existing Use: Vacant

Proposed Use: Detached Condominium

Lot Size: 5869 s.f.

Adjacent Land Uses:

- **North:** SFCI
- **South:** SFCI
- **East:** Open Space
- **West:** Single Family

ATTACHMENTS

Exhibit A: Architectural Plan Set

Exhibit B: Staff/Public Comment



Case Summary: Kristine Perpar of Shift Architectures, Applicant for Lot 167, Unit 3 is requesting Design Review Board (DRB) approval of an Initial Architectural and Site Review (IASR) Application for a new single-family home on Lot 167, Unit 3, 162 San Joaquin Rd. The Lot is approximately 5869 s.f. and is zoned Single-Family Common Interest. The overall square footage of the home is approximately 3,016 gross square feet and provides 1 interior parking space within the proposed garage and 1 exterior parking space.

Applicable CDC Requirement Analysis: The applicable requirements cited may not be exhaustive or all-inclusive. The applicant is required to follow all requirements even if an applicable section of the CDC is not cited. ***Please note that Staff comments will be indicated by italicized Text.***

Table 1

CDC Provision	Requirement	Proposed
Maximum Building Height	35' (shed) / 40' (gable) Maximum	38' - 4 ¾"
Maximum Avg. Building Height	30' (shed) / 35' (gable) Maximum	28' - 1"
Maximum Lot Coverage	1260 s.f.	1217 s.f.
General Easement Setbacks*	No encroachment	None
Roof Pitch		
Primary		12:12
Secondary		2:12
Exterior Material		
Stone	35% minimum	35%
Windows/Doors	40% maximum	22%
Parking	1 enclosed / 1 exterior	1/1

Design variations:

- 1) Tandem parking

Chapter 17.3: ZONING AND LAND USE REGULATIONS

17.3.12: Building Height Limits

Sections 17.3.11 and 17.3.12 of the CDC provide the methods for measuring Building Height and Average Building Height, along with providing the height allowances for specific types of buildings based on their architectural form. The proposed design incorporates both a gable roof and shed roof forms, they are roughly equal in importance, making it difficult to determine which is the "primary" roof form. Staff's initial impression is that this home reads as a gabled roof form, but has asked that the applicant apply both shed and gable height restrictions to their elevations for DRB consideration. The maximum average height must be at or below 30 feet for shed roof forms. The average height is an average of measurements from a point halfway between the roof ridge and eave. The points are generally every 20 feet around the roof. The maximum height is measured from the highest point on a roof directly down to the existing grade or finished grade, whichever is more restrictive.

Regardless of which roof form restriction is applied, the max average roof height is 28' 1" which complies with the more restrictive 30' maximum for shed roof forms. The max height is in compliance with the 40' maximum for gable roofs for the gabled portion of the home and in compliance with the 35' maximum for shed roofs in the shed roof portion of the home.

Staff: the applicant meets all height requirements.

17.3.14: General Easement Setbacks

Lot 167, Unit 3 is platted as an “airspace unit” within the Mountain View Estates PUD. Between each “airspace unit” there is a portion of General Common Element that serves provides open space between the units. There is no general easement within each airspace unit.

Staff: The proposed development is entirely within its designated airspace unit with the exception of driveway access and utilities, which cross the general common element (GCE). These uses are allowed within the GCE.

Chapter 17.5: DESIGN REGULATIONS

17.5.4: Town Design Theme

The Town of Mountain Village has established design themes aimed at creating a strong image and sense of place for the community. Due to the fragile high alpine environment, architecture and landscaping shall be respectful and responsive to the tradition of alpine design – reflecting elements of alpine regions while blending influences that visually tie the town to mountain buildings. The town recognizes that architecture will continue to evolve and create a regionally unique mountain vernacular, but these evolutions must continue to embrace nature and traditional style in a way that respects the design context of the neighborhoods surrounding the site.

Staff: The Units in Mountain View Estates are relatively small in comparison to other lots in Mountain Village. The applicant has designed the home in a way that provides some privacy from the neighboring unit while utilizing the natural contours of the lot to step the home down towards the road access. The materials palette of wood, steel and stone fits within the overall vernacular of the Mountain Village. The stone veneer primarily at the base of the home gives it a sense of groundedness. The horizontal siding with metal recess is a contemporary detail that will give the larger areas of wood siding an appealing texture and visual interest.

The applicant has designed the home with two primary roof planes – a north/south gable and a large shed roof that runs east/west. Because of the orientation of the home on the lot, one would rarely view any of the roofs from straight on, this off-axis view plane will break up what might seemingly be a non-interesting roof form. Overall it appears that the design is visually appealing and would fit within the existing Mountain Village Design Theme.

17.5.5: Building Siting Design

The CDC requires that any proposed development blend into the existing landforms and vegetation.

Staff: The proposed home steps down the site naturally. Existing trees along the west side of the property will be retained allowing for a buffer between the home and the San Joaquin Road to the southwest. Due to the close proximity of the Units, it will be important to maintain existing vegetation in the GCE, which will also help to mitigate view impacts from San Joaquin Road.

17.5.6: Building Design

Staff: The CDC requires that building form and exterior wall forms portray a mass that is thick and strong with a heavy grounded foundation. The building form follows the natural

slope of the lot. The house settles into the hillside and appears very anchored with its' stone clad lower level. Overall, the home looks grounded, and the smaller elevated decks on the main and upper levels are not so large as to counteract this groundedness. It should be noted that the deck posts look like they are sitting on concrete pads. It may be preferable for the DRB to require stone cladding or another material based on previous comfort with this design element.

The applicant has included a complete window and door schedule. The recess depth of all doors and windows in stone areas meets the CDC requirements. Windows are black clad aluminum. The proposed roofing material is a traditional matte black standing seam product. The fascia of the home will be stained doug fir and the soffit will be stained pine. The CDC allows for black and grey standing seam roofing materials and this appears to meet that requirement.

17.5.7: Grading and Drainage Design

Staff: There is extensive retainage on the west side of the home. Prior to final review, the applicant shall revise these plans and specifically document retaining wall heights to make sure they are meeting the requirements of the CDC. A portion of a pre-existing boulder wall on the east side of the home is slated for removal to provide for driveway access. Wherever feasible, they have left the natural grade of the site intact.

17.5.8: Parking Regulations

Staff: The CDC requires all single-family common interest developments to provide one interior and one exterior parking space. The applicant has shown a total of 1 interior space and 1 exterior space that meet the required sizes of 9' x 18'. The spaces are configured in tandem, therefore the vehicle parked in the exterior space will need to be moved for the other vehicle to pull out of the garage. Tandem parking can be allowed on lots of less than .75 acres where non-tandem parking is not feasible due to unique site conditions. DRB will have to determine if this condition is met to allow for the tandem parking request. Additionally, more dimensions need to be provided to understand whether the the drive meets turn around requirements.

17.5.9: Landscaping Regulations

The applicant has provided a high-level preliminary landscaping plan. The plan indicates the addition of 7 aspen trees. Staff encourages the applicant to increase the planting schedule for the home and to also proposed a variety of plantings to provide a transition from the landscaped areas of the home to the native forest beyond.

17.5.11: Utilities

Staff: It is assumed that all utilities are located within the San Joaquin roadway, but need to be field verified. Utilities will only require connections to the home. The applicant has indicated that the utility location at the home will be under the north deck, therefore primarily hidden from view. The applicant shall work with the Public Works Director and all other utilities to locate access points.

17.5.12: Lighting Regulations

Staff: The applicant has provided an exterior lighting plan with fixture specifications. A photometric study will be required for final review. The lighting plan includes only two kinds of fixtures. A wall mounted sconce with down light and a step light. Both of these fixtures appear to meet the regulations of the CDC.

17.5.13: Sign Regulations

Staff: The address marker is within the airspace unit on the north side of the driveway. It uses materials that match the home, and the indicated heights and lettering meet CDC guidelines. Lighting is indicated as required per the CDC. Numbers will be reflective and presented on a steel plate. It is unclear whether the illumination will be sufficient as the design indicates that the number panel is recessed ½” into the stone slab and the lighting is inside a channel that seems to be proud of the slab. The applicant should provide clarification for final review as well as a specification for the indicated LED light.

Chapter 17.6: SUPPLEMENTARY REGULATIONS

17.6.1: Environmental Regulations

Staff: Fire Mitigation and Forestry Management: The applicant has submitted a fire mitigation plan that mostly meets the Forestry provisions of the CDC, however there are five small evergreen trees on the south corner of the lot that per code should be removed. Any landscaping (including tree removal) outside of the Unit is to be completed by the Association per the condo declarations.

17.6.6: Roads and Driveway Standards

Staff: The owner of Unit 3 is also the owner of Unit 4 to the NW. The driveway access shown is actually two parts, the main access – which will continue on to Unit 4 when it is developed, and the designated Unit 3 driveway. It appears that the main access grade is between 3-6.5% and the driveway access grade is between .75 and 4.4%, both of which meet the grade requirements of the CDC. More dimensions need to be provided to understand whether the drive meets both width and turn around requirements. It may be helpful for the engineer designing the driveways to coordinate the future planning of all remaining developable units into this design.

17.6.8: Solid Fuel Burning Device Regulations

Staff: The applicant has indicated that the proposed home does include a fireplace and that it is to run on natural gas.

Chapter 17.7: BUILDING REGULATIONS

17.7.19: Construction Mitigation

Staff: The construction mitigation plan shows required material staging, dumpster, bear-proof trash receptacles, parking and a port a toilet. The construction fencing is generally out of the GE, except at the driveway access. The construction staging and dumpster as indicated on the CMP are located on the neighboring Unit 4. It is understood by staff that this Unit will also be developed shortly. If development doesn't proceed as planned the applicant shall be required to revegetate any disturbance on the Unit 4 site to pre-construction standards. No crane is indicated on the CMP, if it is determined that one is required, the applicant shall work with town staff to make sure the crane swing doesn't impede the roadway.

Staff Recommendation: Staff recommends the DRB approve the Final Architectural Review for Lot 167, Unit 3, 162 San Joaquin Rd. based on the findings and CDC requirements listed in the staff memo of record.

Staff Note: *It should be noted that reasons for approval or rejection should be stated in the findings of fact and motion.*

Proposed Motion:

If the DRB deems this application to be appropriate for approval, Staff requests said approval condition the items listed below in the suggested motion.

I move to approve the Initial Architectural and Site Review for a new single-family home located at Lot 167, Unit 3, based on the evidence provided within the Staff Report of record dated February 23, 2021, with the following conditions:

- 1) Prior to final review, the applicant shall modify the landscaping plan to include additional tree plants to increase variety of species on the Unit.
- 2) Prior to final review, the applicant shall include a lighting specification for the address monument that complies with the CDC lighting standards, and shall revise the monument design to clarify the depth of such lighting fixture within the monument.
- 3) Prior to final review, the applicant will provide driveway dimensions that verify compliance with CDC regulations for driveway standards and turn-arounds.
- 4) Prior to the issuance of a building permit, the applicant shall field verify all utilities and submit a revised utility plan to the public works director identifying the location of utilities and connection points.
- 5) Prior to issuance of CO, all disturbances in the GE caused by construction will be re-graded and re-vegetated to pre-construction standards; and if construction on Unit 4 has not commenced, any disturbance on that site will be brought back to pre-construction standards as well.
- 6) Consistent with town building codes, Unenclosed accessory structures attached to buildings with habitable spaces and projections, such as decks, shall be constructed as either non-combustible, heavy timber or exterior grade ignition resistant materials such as those listed as WUIC (Wildland Urban Interface Code) approved products.
- 7) A monumented land survey shall be prepared by a Colorado public land surveyor to establish the maximum building height and the maximum average building height.
- 8) A monumented land survey of the footers will be provided prior to pouring concrete to determine there are no additional encroachments into the GE.
- 9) Prior to the Building Division conducting the required framing inspection, a four-foot (4') by eight-foot (8') materials board will be erected on site consistent with the review authority approval to show:
 - a. The stone, setting pattern and any grouting with the minimum size of four feet (4') by four feet (4');
 - b. Wood that is stained in the approved color(s);
 - c. Any approved metal exterior material;
 - d. Roofing material(s); and
 - e. Any other approved exterior materials

/aw

Date: February 1, 2021
By: Kristine Perpar, Architect

Property address:

162 San Joaquin; Unit 3
Telluride, CO 81435

Sent to: MV DRB

Re: Development of a Single Family Residence

Dear Mountain Village Design Review Board,

The proposed home for Unit 3; Mountain View Estates was designed to capture the views of the San Sofia Ridge, sensitivity to the site and neighbors and the existing topography.

Unit 3 is currently vacant of structures and covered with trees. The building site has a constant slope down towards the west.

The driveway is situated on the eastern part of the lot connecting to existing drive for the entire development.

Exterior elevations, plans and roof are simple in form. Roofs are all gabled / Shed roofs at a 2:12 3:12 & a 4:12 pitch with the main gable at a 12:12 pitch. Exterior materials; stone, metal and wood accents were selected for their sensitivity to the environment, neighboring properties and for durability.

The proposed landscape plan is simple. Aspen trees to be planted on either side of the structure.

Sincerely,



Kristine Perpar

Site Photos MVE



Lot 1



Driveway View



Lot 3 & 4



Lot 3



Lot 2

GENERAL NOTES:

CONTRACT DOCUMENTS:

CONTRACT DOCUMENTS CONSIST OF THE AGREEMENT, GENERAL CONDITIONS, SPECIFICATIONS, DETAIL BOOK AND DRAWINGS, WHICH ARE COOPERATIVE AND CONTINUOUS. WORK INDICATED OR REASONABLY IMPLIED IN ANY ONE OF THE DOCUMENTS SHALL BE SUPPLIED AS THOUGH FULLY COVERED IN ALL. ANY DISCREPANCIES BETWEEN THE PARTS SHALL BE REPORTED TO THE ARCHITECT PRIOR TO THE COMMENCEMENT OF WORK. THESE DRAWINGS ARE PART OF THE CONTRACT DOCUMENTS FOR THIS PROJECT. THESE DRAWINGS ARE THE GRAPHIC ILLUSTRATION OF THE WORK TO BE ACCOMPLISHED. ALL DIMENSIONS NOTED TAKE PRECEDENCE OVER SCALED DIMENSIONS. DIMENSIONS NOTES WITH "N.T.S." DENOTES NOT TO SCALE.

ORGANIZATION:

THE DRAWINGS FOLLOW A LOGICAL, INTERDISCIPLINARY FORMAT: ARCHITECTURAL DRAWINGS (A SHEETS), CIVIL DRAWINGS (C SHEETS), STRUCTURAL (S SHEETS), MECHANICAL AND PLUMBING (M SHEETS), ELECTRICAL (E SHEETS) AND LIGHTING (LTG SHEETS).

CODE COMPLIANCE:

ALL WORK, MATERIALS AND ASSEMBLIES SHALL COMPLY WITH APPLICABLE STATE AND LOCAL CODES, ORDINANCES AND REGULATIONS. THE CONTRACTOR, SUBCONTRACTORS AND JOURNEMEN OF THE APPROPRIATE TRADES SHALL PERFORM WORK TO THE HIGHEST STANDARDS OF CRAFTSMANSHIP AND IN ACCORDANCE WITH AIA DOCUMENT A201-SECTION 3. THE BUILDING INSPECTOR SHALL BE NOTIFIED BY THE CONTRACTOR WHEN THERE IS NEED OF INSPECTION AS REQUIRED BY THE INTERNATIONAL BUILDING CODE OR ANY LOCAL CODE OR ORDINANCE.

INTENT:

THESE DOCUMENTS ARE INTENDED TO INCLUDE ALL LABOR, MATERIALS, EQUIPMENT AND SERVICES REQUIRED TO COMPLETE THE WORK DESCRIBED HEREIN.

COORDINATION:

THE CONTRACTOR SHALL CAREFULLY STUDY AND COMPARE THE DOCUMENTS. VERIFY ACTUAL CONDITIONS AND REPORT ANY DISCREPANCIES, ERRORS OR OMISSIONS TO THE ARCHITECT IN A TIMELY MANNER. THE ARCHITECT SHALL CLARIFY OR PROVIDE REASONABLE ADDITIONAL INFORMATION REQUIRED FOR SUCCESSFUL EXECUTION. THE CONTRACTOR SHALL VERIFY AND COORDINATE ALL OPENINGS THROUGH FLOORS, CEILINGS AND WALLS WITH ALL ARCHITECTURAL, INTERIOR, STRUCTURAL, MECHANICAL AND PLUMBING, ELECTRICAL AND LIGHTING DRAWINGS. CONTRACTOR WILL ASSUME RESPONSIBILITY OF ITEMS REQUIRING COORDINATION AND RESOLUTION DURING THE BIDDING PROCESS.

SUBSTITUTIONS:

ANY MATERIALS PROPOSED FOR SUBSTITUTION OF THOSE SPECIFIED OR THE CALLED-OUT-BY-TRADE-NAME IN THESE DOCUMENTS SHALL BE PRESENTED TO THE ARCHITECT FOR REVIEW. THE CONTRACTOR SHALL SUBMIT SAMPLES WHEN REQUIRED BY THE ARCHITECT AND SUCH SAMPLES SHALL BE REVIEWED BY THE ARCHITECT BEFORE THE WORK IS PERFORMED. WORK MUST CONFORM TO THE REVIEWED SAMPLES. ANY WORK WHICH DOES NOT CONFORM SHALL BE REMOVED AND REPLACED WITH WORK WHICH CONFORMS AT THE CONTRACTOR'S EXPENSE. SUBCONTRACTORS SHALL SUBMIT REQUESTS FOR REVIEW THROUGH THE GENERAL CONTRACTOR WHEN WORK IS LET THROUGH HIM OR HER. REQUIRED VERIFICATION AND SUBMITTALS TO BE MADE IN ADEQUATE TIME AS NOT TO DELAY WORK IN PROGRESS.

SHOP DRAWINGS:

SHOP DRAWINGS SHALL BE SUBMITTED TO THE ARCHITECT FOR HIS OR HER REVIEW WHERE CALLED FOR ANYWHERE IN THESE DOCUMENTS. REVIEW SHALL BE MADE BY THE ARCHITECT BEFORE WORK IS BEGUN, AND WORK SHALL CONFORM TO THE REVIEWED SHOP DRAWINGS, SUBJECT TO REPLACEMENT AS REQUIRED IN PARAGRAPH "SUBSTITUTIONS" ABOVE.

SAFETY & PROTECTION OF WORK:

THE CONTRACTOR SHALL BE RESPONSIBLE FOR THE SAFETY AND CARE OF ADJACENT PROPERTIES DURING CONSTRUCTION FOR COMPLIANCE WITH FEDERAL AND STATE O.S.H.A. REGULATIONS, AND FOR THE PROTECTION OF ALL WORK UNTIL IT IS DELIVERED COMPLETED TO THE OWNER.

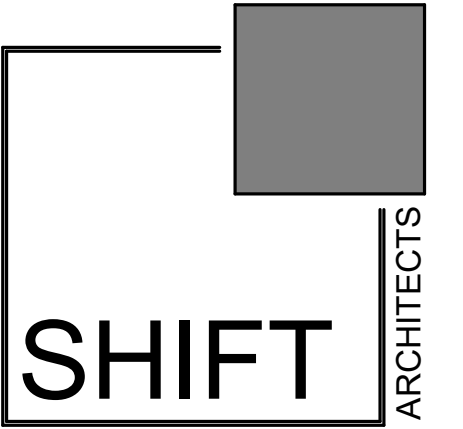

P.O. Box 3206
100 W. Colorado Suite 211
Telluride, Colorado 81435
p 970-728-8145
kristine@shift-architects.com
www.shift-architects.com

PROJECT ISSUE DATE:
02.01.21 DRB PRELIMINARY
SUBMITTAL

REVISIONS

NO. DATE DESC.

MOUNTAIN VIEW ESTATES UNIT 3
 162 SAN JOAQUIN RD. 3, MOUNTAIN VILLAGE, CO 81435
 UNIT 3 MOUNTAIN VIEW ESTATES, TOWN OF MOUNTAIN VILLAGE, SAN MIGUEL COUNTY, ACCORDING TO THE MAP RECORDED NOVEMBER 28, 2005 IN
 PLAT BOOK 1 AT PAGE 3573, AND AS DEFINED AND DESCRIBED IN THE DECLARATION OF COMMON INTEREST COMMUNITY FOR MOUNTAIN VIEW
 ESTATES, RECORDED NOVEMBER 28, 2005 UNDER RECEPTION NO. 379791 AND AS AMENDED BY INSTRUMENT RECORDED DECEMBER 5, 2018 UNDER
 RECEPTION NO. 456632, COUNTY OF SAN MIGUEL, STATE OF COLORADO.

PROJECT CODE INFORMATION

ZONING	RESIDENTIAL CONDOMINIUM
SUBDIVISION:	MOUNTAIN VIEW ESTATES
BUILDING CODE	IRC 2018 AND ALL APPLICABLE CODES AS REQUIRED BY THE TOWN OF MOUNTAIN VILLAGE
DESIGN REQUIREMENTS:	AMENDED AND RESTATED DECLARATION OF COMMON INTEREST COMMUNITY IN ADDITION TO ALL REQUIREMENTS BY THE TOWN OF MOUNTAIN VILLAGE
DESCRIPTION	MULTI-STORY DWELLING
AUTOMATIC FIRE SPRINKLER	PER NFPA - SPRINKLED OVER 3,600 SF N/A
FIRE RESISTIVE RATING	GARAGE - 1 HR MECHANICAL - 1 HR

PROJECT INFORMATION

MAX RESIDENCE SQUARE FOOTAGE: ALLOWABLE	3,780 SF	MAX BUILDING HEIGHT: ALLOWABLE	40'-0" (35'-0" + 5'-0" GABLE RIDGE, CDC TABLE 3-3 FOOTNOTE 1)
PROPOSED RESIDENCE FLOOR AREA:		PROPOSED	38'-4 3/4"
LOWER LEVEL	844.88 SF	MAX AVERAGE HEIGHT: ALLOWABLE	35'-0" (30'-0" + 5'-0" GABLE RIDGE, CDC TABLE 3-3 FOOTNOTE 1)
GROUND LEVEL	1,219.76 SF	PROPOSED	28'-1"
UPPER LEVEL	951.23 SF	PARKING REQUIRED:	2 SPACES PROVIDED (2 REQUIRED) (1 ENCLOSED IN GARAGE) (1 SURFACE SPACE)
TOTAL FLOOR AREA: GARAGE	<u>3,015.87 SF</u> 372 SF		
TOTAL:	<u>3,387.87 SF</u>		
RESIDENCE BUILDING FOOTPRINT: ALLOWABLE PROPOSED	1,260 SF 1,216.88 SF		

SEE SHEET A2.1 FOR MAXIMUM BUILDING HEIGHT
CALCULATION

SHEET INDEX

GENERAL

- G1.0 COVER SHEET
- G1.1 ABBREVIATIONS AND LEGENDS

CIVIL

- C1 NOTES
- C2 GRADING AND DRAINAGE PLAN
- C3 UTILITY PLAN

SURVEY / MAPPING

- 0 SURVEY

ARCHITECTURAL

- A1.1 ARCHITECTURAL SITE PLAN
- A1.2 BUILDING SITE PLAN
- A1.3 LANDSCAPE PLAN
- A1.4 CONSTRUCTION MITIGATION PLAN
- A2.1 MAX BUILDING HEIGHT / RESIDENCE BUILDING
FOOTPRINT CALCULATIONS
- A2.2 MATERIAL CALCULATIONS
- A3.1 FLOOR PLANS
- A3.2 FLOOR PLANS
- A3.3 FLOOR PLANS
- A3.4 ROOF PLAN
- A4.0 AXONS
- A4.1 EXTERIOR ELEVATIONS
- A4.2 EXTERIOR ELEVATIONS
- A4.3 PRESENTATION ELEVATIONS
- A8.1 DOOR SCHEDULE
- A8.2 WINDOW SCHEDULE

- LTG1.1 LIGHTING PLAN
- LTG1.2 LIGHTING PLAN

VICINITY MAP

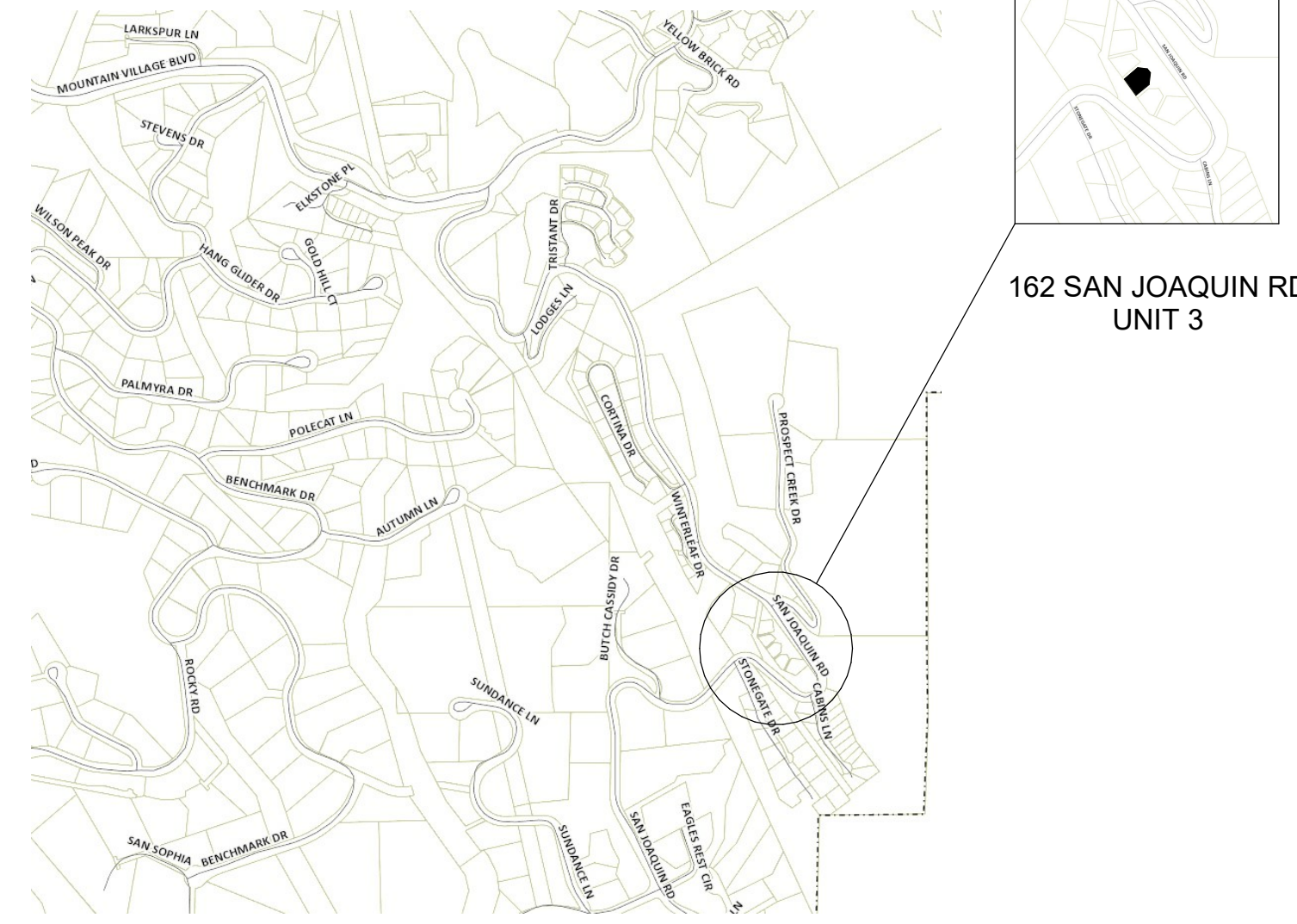

PROJECT TEAM

OWNER:

BARILOCHE LLC A DE LLC
3521 N 32ND TER
HOLLYWOOD, FL 33021-2618

ARCHITECT:

SHIFT ARCHITECTS
KRISTINE PERPAR - ARCHITECT
100 WEST COLORADO STE. 211
TELLURIDE, CO 81435
P. 970.275.0263
kristine@shift-architects.com

GENERAL CONTRACTOR:

HOINS CONSTRUCTION
BILL HOINS
137 SOCIETY DRIVE
TELLURIDE, CO 81435
P. 970.728.9371
hoinsoffice@gmail.com

SURVEYOR:

SAN JUAN SURVEYING
CHRISTOPHER R. KENNEDY
102 SOCIETY DRIVE
TELLURIDE, CO 81435
P. 970.728.1128
office@sanjuansurveying.net

CIVIL:

UNCOMPAGRE ENGINEERING LLC
DAVID BALLODE P.E.
PO BOX 3945
TELLURIDE, CO 81435
P. 970.729.0683
dballode@msn.com

STRUCTURAL:

ANVIL ENGINEERING, LLC
CHRIS BURNETT, P.E.
3247 E. 7TH AVENUE
DURANGO, CO 81301
P. 970.988.2576
chris@anvil-EFD.com

MECHANICAL:

HUGHES CONSULTING ENGINEERING, PA
DIMITRI MERRILL, P.E.
TELLURIDE, CO 81435
P. 970.239.1949
F. 785.842.2492
dimitri@hce-pa.com

LANDSCAPING:

SHIFT ARCHITECTS
KRISTINE PERPAR - ARCHITECT
100 WEST COLORADO STE. 211
TELLURIDE, CO 81435
P. 970.275.0263
kristine@shift-architects.com

COVER SHEET

SHEET NUMBER

G1.0

2/3/2021 9:23:35 AM

NOT FOR CONSTRUCTION

@shift architects

SYMBOL LEGEND

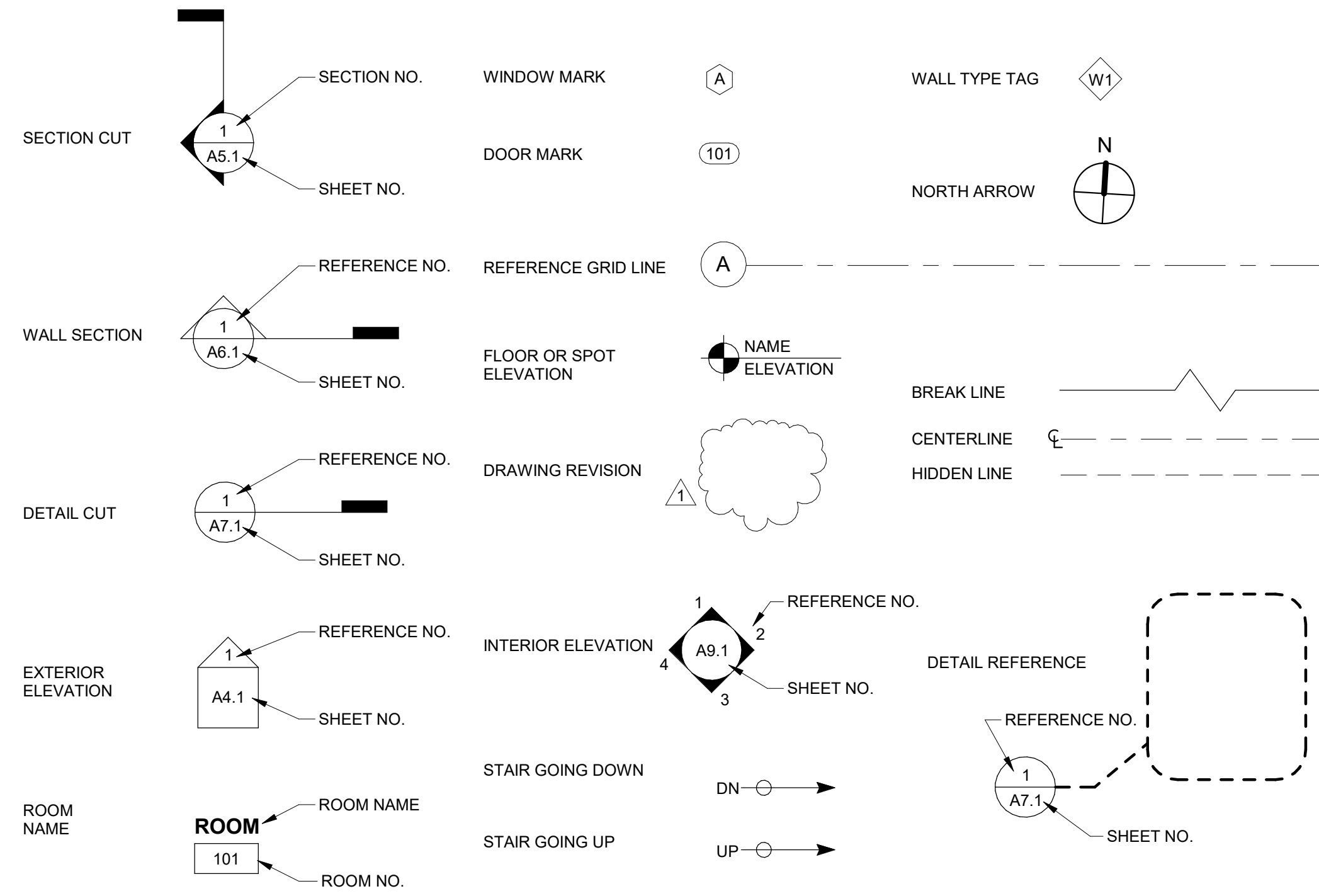

MATERIAL LEGEND

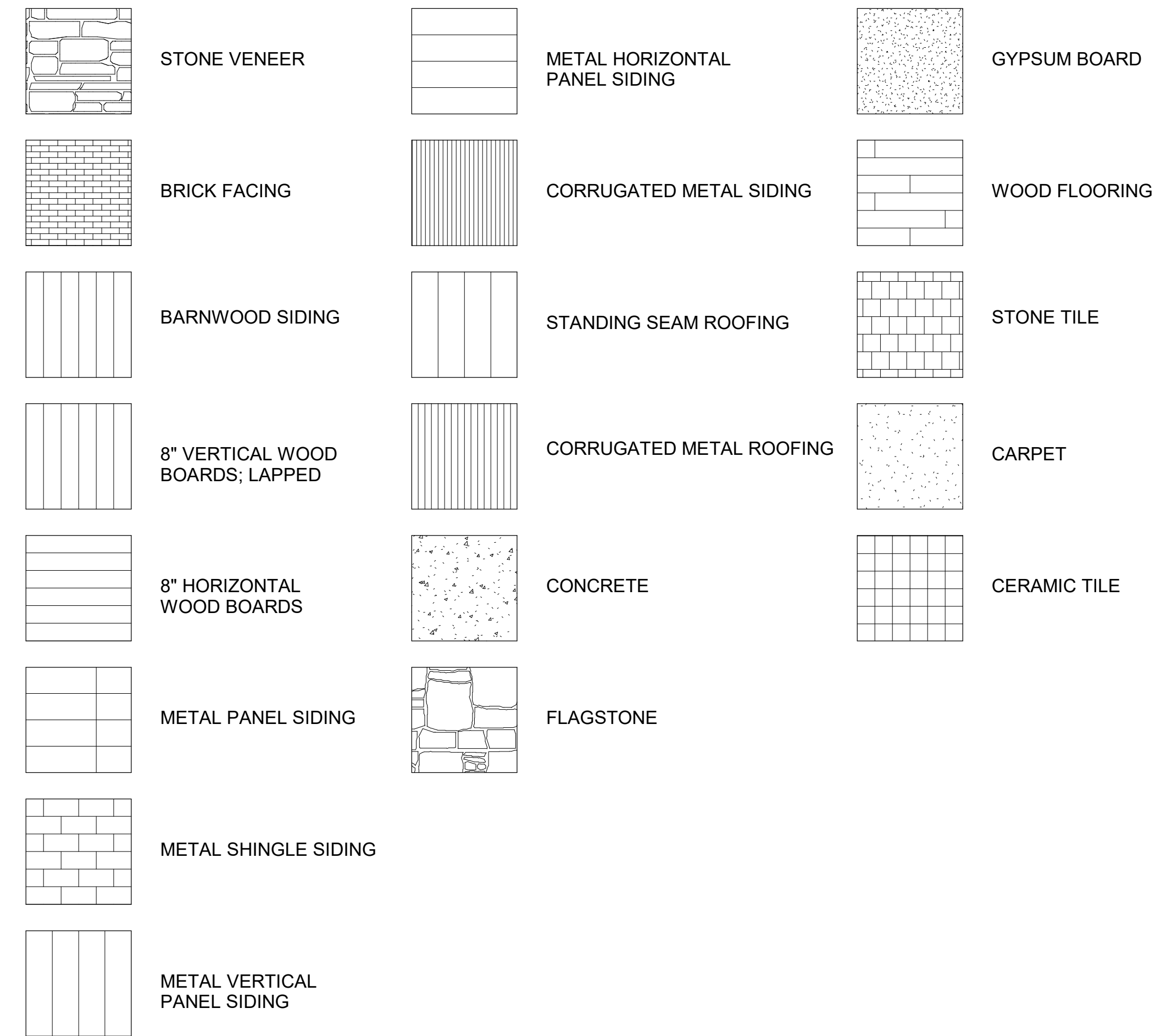

ABBREVIATIONS

AC	Acres
AFF	Above Finished Floor
AGG	Aggregate
AL	Aluminum
BM	Bench Mark
BSN	Basin
BTH	Bath
CL	Centre Line
CJ	Control Join
CLST	Closet
CP	Carpet
CT	Ceramic Tile
DIA	Diameter
DP	Downpipe
DW	Dishwasher
EX	Existing
FF	Finished Floor
FHR	Fire Hose Reel
FP	Flue Pipe
GAL	Galvanized
GL	Ground Line
GFI	Ground Fault Circuit Interrupter
GPO	General Power Outlet
IBC	International Building Code
MDF	Medium Density Fibreboard
MR	Metal Roofing
MSB	Main Switch Board
NTS	Not To Scale
PFC	Parallel Flanged Steel Channel
PL	Plastic Laminate
PT	Paint
RC	Reinforced Concrete
REF	Refrigerator
RL	Reduced Level
S	Sanitary Drainage Pipe
SHR	Shower
SK	Sink
SN	Stone
SS	Stainless Steel
ST	S Trap
STF	Steel Trowel Finished Concrete
SW	Stormwater Drainage Line
T&G	Tongue and Grooved
TO	Top Of
TPH	Toilet Paper Holder
TR	Tiled Roofing
TSF	Timber Strip Floor
TYP	Typical
U	Urinal
UOS	Unless Otherwise Specified
V	Valley
VIF	Verify In Field
VP	Vent Pipe
WC	Water Closet (Toilet)
WM	Washing Machine
WPM	Water Proof Membrane

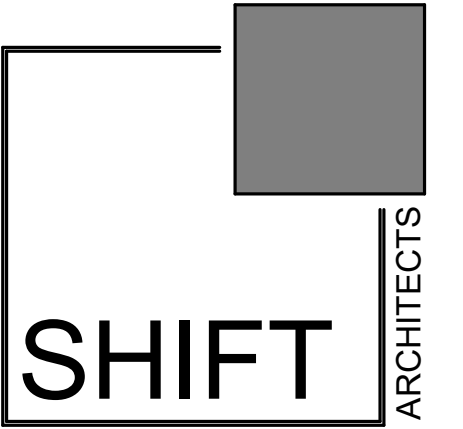

P.O. Box 3206
 100 W. Colorado Suite 211
 Telluride, Colorado 81435
 p 970-728-8145
 kristine@shift-architects.com
 www.shift-architects.com

PROJECT ISSUE DATE:
 02.01.21 DRB PRELIMINARY
 SUBMITTAL

REVISIONS
 NO. DATE DESC.

MOUNTAIN VIEW ESTATES UNIT 3
 162 SAN JOAQUIN RD. 3, MOUNTAIN VILLAGE, CO 81435
 UNIT 3 MOUNTAIN VIEW ESTATES, TOWN OF MOUNTAIN VILLAGE, SAN MIGUEL COUNTY, ACCORDING TO THE MAP RECORDED NOVEMBER 28, 2005 IN
 PLAT BOOK 1 AT PAGE 3573, AND AS DEFINED AND DESCRIBED IN THE DECLARATION OF COMMON INTEREST COMMUNITY FOR MOUNTAIN VIEW
 ESTATES, RECORDED NOVEMBER 28, 2005 UNDER RECEPTION NO. 379791 AND AS AMENDED BY INSTRUMENT RECORDED DECEMBER 5, 2018 UNDER
 RECEPTION NO. 456632, COUNTY OF SAN MIGUEL, STATE OF COLORADO.

ABBREVIATIONS AND
 LEGENDS

SHEET NUMBER

G1.1

NOT FOR CONSTRUCTION

©shift architects

WALL LEGEND

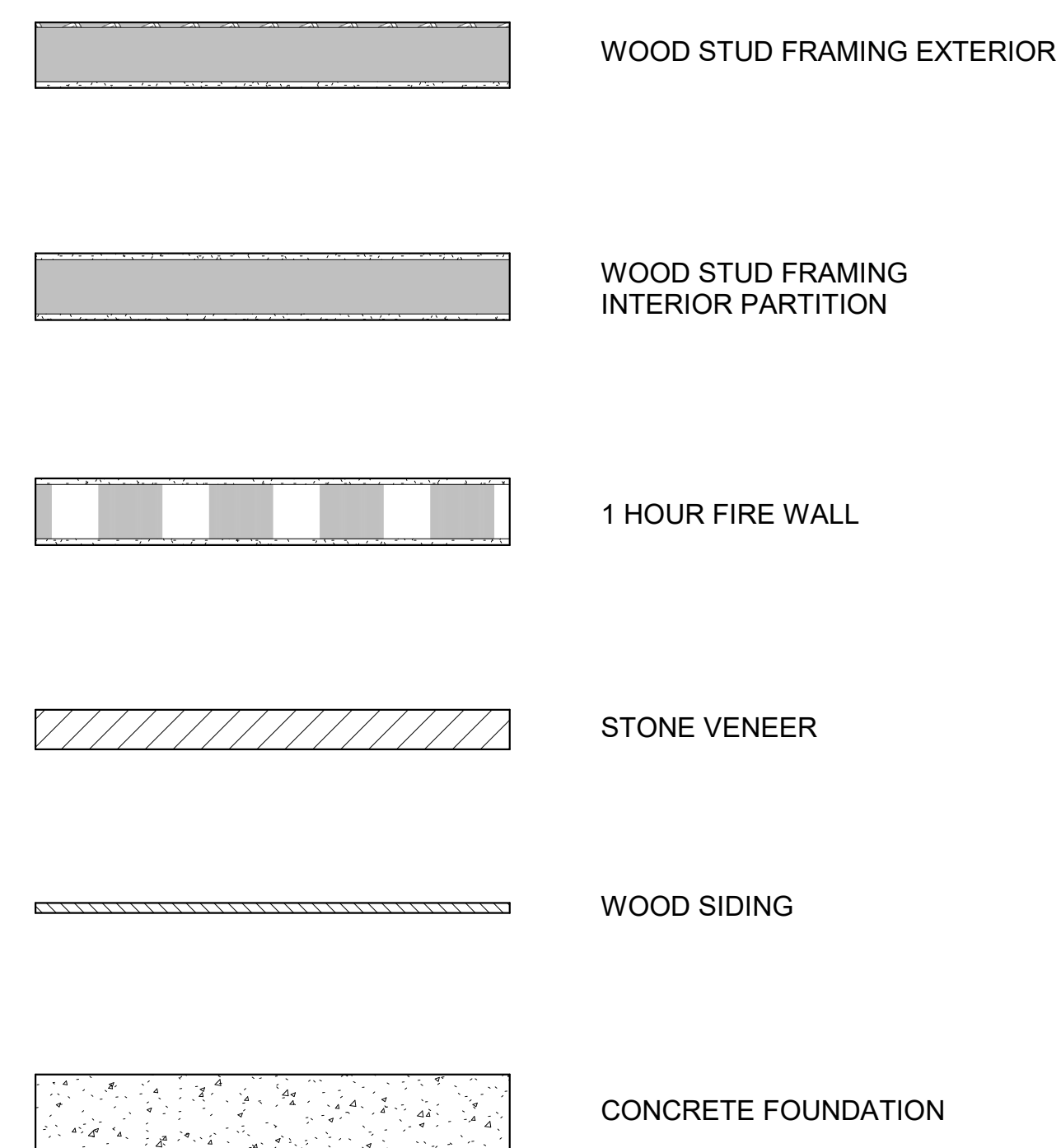

DIMENSIONING LEGEND

- GRIDS ALIGN WITH OUTSIDE FACE OF FOUNDATION WALL AND OUTSIDE FACE OF STUD AT EXTERIOR STRUCTURAL FRAME WALL.
- WALLS AND PARTITIONS SHOWN IN PLAN INCLUDE FINISH MATERIALS.
- DIMENSIONS ARE SHOWN FROM GRID TO GRID, GRID TO FACE OF STUD, AND FACE OF STUD TO FACE OF STUD AT INTERIOR PARTITIONS, TYPICAL.
- INTERIOR PARTITIONS FLUSH FACE TO FACE WITH THEIR EXTERIOR COUNTERPARTS, TYPICAL.

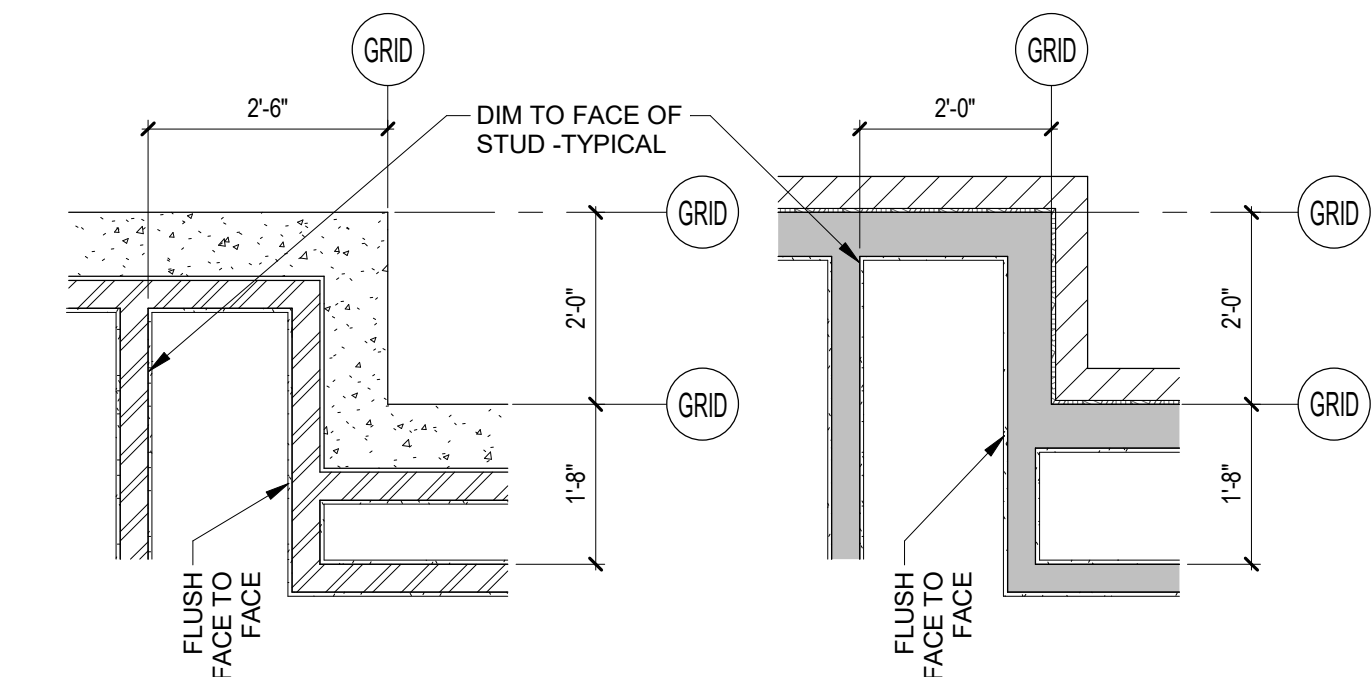

PROJECT DATUM LEGEND

ACTUAL ELEVATION ABOVE SEA LEVEL = PROJECT 0'-0"

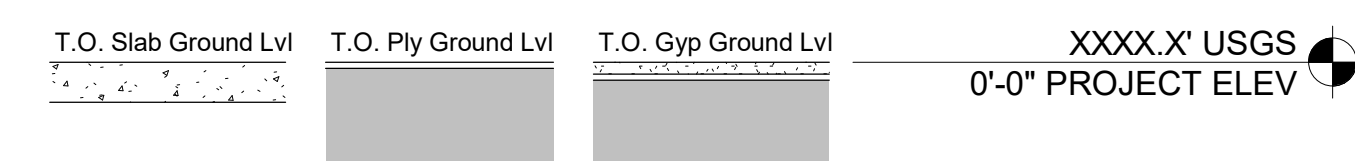

2/3/2021 9:23:35 AM

GENERAL CIVIL ENGINEERING NOTES:

1. THE EXISTING UTILITY LINES SHOWN ON THE PLANS ARE APPROXIMATE. AT LEAST TWO (2) FULL WORKING DAYS PRIOR TO COMMENCING CONSTRUCTION, THE CONTRACTOR SHALL CONTACT THE UTILITY NOTIFICATION CENTER OF COLORADO @ 1-800-922-1987 OR 811 TO GET ALL UTILITIES LOCATED. IF ANY OF THESE UNDERGROUND UTILITIES ARE IN CONFLICT WITH THE CONSTRUCTION PLANS, THE CONTRACTOR SHALL NOTIFY THE ENGINEER AND WORK WITH THE ENGINEER TO FIND A SOLUTION BEFORE THE START OF CONSTRUCTION.

INSTALLATION AND SEPARATION REQUIREMENTS SHALL BE COORDINATED WITH THE INDIVIDUAL UTILITY PROVIDERS.

THE UTILITY PROVIDERS ARE:
SEWER, WATER, CABLE TV AND FIBEROPTIC: TOWN OF MOUNTAIN VILLAGE
NATURAL GAS: BLACK HILLS ENERGY
POWER: SAN MIGUEL POWER
TELEPHONE: CENTURY LINK

2. PRIOR TO BEGINNING ANY CONSTRUCTION ACTIVITIES, ALL NECESSARY PERMITS SHALL BE OBTAINED BY THE OWNER OR CONTRACTOR.

3. IT IS THE CONTRACTOR'S RESPONSIBILITY TO INSURE THAT EXCAVATED SLOPES ARE SAFE AND COMPLY WITH OSHA REQUIREMENTS. REFER TO THE SITE-SPECIFIC REPORT FOR THIS PROJECT FOR ADDITIONAL INFORMATION.

4. ALL TRENCHES SHALL BE ADEQUATELY SUPPORTED OR LAID BACK PER OSHA REGULATIONS.

5. ALL MATERIALS AND CONSTRUCTION SHALL BE IN CONFORMANCE WITH THE TOWN OF MOUNTAIN VILLAGE DESIGN STANDARDS LATEST EDITION. ALL CONSTRUCTION WITHIN EXISTING STREET OR ALLEY RIGHT-OF-WAY SHALL BE SUBJECT TO TOWN OF MOUNTAIN VILLAGE INSPECTION.

6. THE CONTRACTOR SHALL HAVE ONE COPY OF THE STAMPED PLANS ON THE JOB SITE AT ALL TIMES.

7. THE CONTRACTOR SHALL NOTIFY THE TOWN 48 HOURS PRIOR TO THE START OF CONSTRUCTION.

8. THE CONTRACTOR IS RESPONSIBLE FOR IMPLEMENTING AND MAINTAINING EROSION AND SEDIMENT CONTROL MEASURES AT ALL TIMES DURING CONSTRUCTION. THE ADJOINING ROADWAYS SHALL BE FREE OF DEBRIS AT THE END OF CONSTRUCTION ACTIVITIES EACH DAY.

9. THE CONTRACTOR SHALL PROVIDE, ERECT AND MAINTAIN PROPER TRAFFIC CONTROL DEVICES UNTIL THE SITE IS OPEN TO TRAFFIC. ANY TRAFFIC CLOSURES MUST BE COORDINATED WITH THE TOWN OF MOUNTAIN VILLAGE.

10. ALL DAMAGE TO PUBLIC STREETS AND ROADS, INCLUDING HAUL ROUTES, TRAILS, OR STREET IMPROVEMENTS, OR TO PRIVATE PROPERTY, SHALL BE REPAIRED AT THE SOLE EXPENSE OF THE CONTRACTOR TO THE ORIGINAL CONDITIONS.

11. WHEN AN EXISTING ASPHALT STREET IS CUT, THE STREET MUST BE RESTORED TO A CONDITION EQUAL TO OR BETTER THAN ITS ORIGINAL CONDITION. THE FINISHED PATCH SHALL BLEND SMOOTHLY INTO THE EXISTING SURFACE. ALL LARGE PATCHES SHALL BE PAVED WITH AN ASPHALT LAY-DOWN MACHINE.

12. IF DEWATERING IS REQUIRED, THE CONTRACTOR SHALL NOTIFY THE ENGINEER. ANY DISCHARGE REQUIREMENTS SHALL BE COORDINATED WITH THE TOWN OF MOUNTAIN VILLAGE.

13. CONTRACTOR SHALL NOTIFY ALL RESIDENTS IN WRITING 24 HOURS PRIOR TO ANY SHUT-OFF IN SERVICE. THE NOTICES MUST HAVE CONTRACTOR'S PHONE NUMBER AND NAME OF CONTACT PERSON, AND EMERGENCY PHONE NUMBER FOR AFTER HOURS CALLS. ALL SHUT-OFFS MUST BE APPROVED BY THE TOWN AND TOWN VALVES AND APPURTENANCES SHALL BE OPERATED BY TOWN PERSONNEL.

14. CONTRACTOR SHALL KEEP SITE CLEAN AND LITTER FREE (INCLUDING CIGARETTE BUTTS) BY PROVIDING A CONSTRUCTION DEBRIS TRASH CONTAINER AND A BEAR-PROOF POLY-CART TRASH CONTAINER, WHICH IS TO BE LOCKED AT ALL TIMES.

15. CONTRACTOR MUST BE AWARE OF ALL TREES TO REMAIN PER THE DESIGN AND APPROVAL PROCESS AND PROTECT THEM ACCORDINGLY.

16. THE CONTRACTOR SHALL PROVIDE UNDERGROUND UTILITY AS-BUILTS TO THE TOWN.

17. ALL STRUCTURAL FILL UNDER HARDSCAPE OR ROADS MUST BE COMPACTED TO 95% MODIFIED PROCTOR (MIN.) AT PLUS OR MINUS 2% OF THE OPTIMUM MOISTURE CONTENT. NON-STRUCTURAL FILL SHALL BE PLACED AT 90% (MIN.) MODIFIED PROCTOR.

18. UNSUITABLE MATERIAL SHALL BE REMOVED AS REQUIRED BY THE SOILS ENGINEER. ALL MATERIALS SUCH AS LUMBER, LOGS, BRUSH, TOPSOIL OR ORGANIC MATERIALS OR RUBBISH SHALL BE REMOVED FROM ALL AREAS TO RECEIVE COMPACTED FILL.

19. NO MATERIAL SHALL BE COMPACTED WHEN FROZEN.

20. NATIVE TOPSOIL SHALL BE STOCKPILED TO THE EXTENT FEASIBLE ON THE SITE FOR USE ON AREAS TO BE REVEGETATED.

21. THE CONTRACTOR SHALL BE RESPONSIBLE FOR DUST ABATEMENT AND EROSION CONTROL MEASURES DEEMED NECESSARY BY THE TOWN, IF CONDITIONS WARRANT THEM.

22. ALL DISTURBED GROUND SHALL BE RE-SEEDED WITH A TOWN-APPROVED SEED MIX. REFER TO THE LANDSCAPE PLAN.

23. THE CONTRACTOR IS REQUIRED TO PROTECT ALL EXISTING SURVEY MONUMENTS AND PROPERTY CORNERS DURING GRADING AND CONSTRUCTION.

24. ALL UNDERGROUND PIPE SHALL BE PROTECTED WITH BEDDING TO PROTECT THE PIPE FROM BEING DAMAGED.

25. HOT TUBS SHALL DRAIN TO THE SANITARY SEWER (OR PUMPED TO AA CLEAN-OUT).

26. THE UTILITY PLAN DEPICTS FINAL UTILITY LOCATIONS BUT HAS BEEN COMPLETED AT A PRELIMINARY STAGE. CONTRACTOR SHALL VERIFY ALIGNMENTS WITH THE ARCHITECT PRIOR TO CONSTRUCTION.

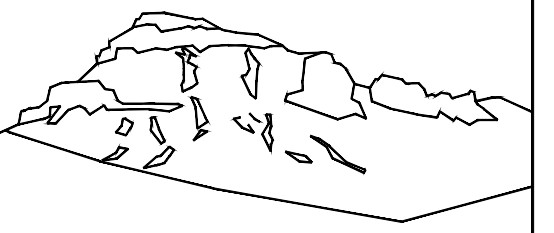

Uncompahgre
Engineering, LLC

P.O. Box 3945
Telluride, CO 81435
970-729-0683

SUBMISSIONS:

DRB Submittal 2021-02-01

162 San Joaquin
Unit 3
Mtn. Village, CO



CONTRACTOR TO REVIEW AND COMPARE ALL CHAPTERS AND INTERDISCIPLINARY DRAWINGS AND REPORT ANY DISCREPANCIES TO THE ARCHITECT PRIOR TO ANY FIELD WORK BEING DONE IN ACCORDANCE WITH AIA DOCUMENT A201

Notes

C1

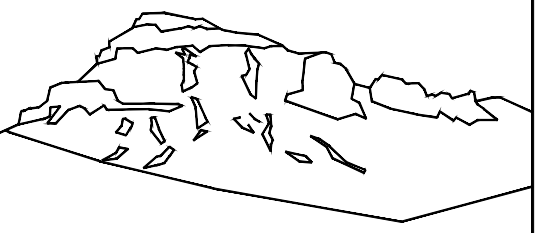

Uncompahgre
Engineering, LLC

P.O. Box 3945
Telluride, CO 81435
970-729-0683

SUBMISSIONS:
DRB Submittal 2021-02-01

162 San Joaquin
Unit 3
Mtn. Village, CO



CONTRACTOR TO REVIEW AND COMPARE ALL
CHAPTERS AND INTERDISCIPLINARY DRAWINGS
AND REPORT ANY DISCREPANCIES TO THE
ARCHITECT PRIOR TO ANY FIELD WORK BEING
DONE IN ACCORDANCE WITH AIA DOCUMENT A201

Grading
and
Drainage

C2

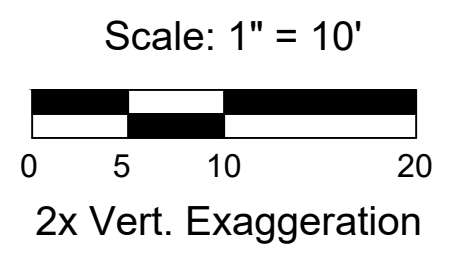
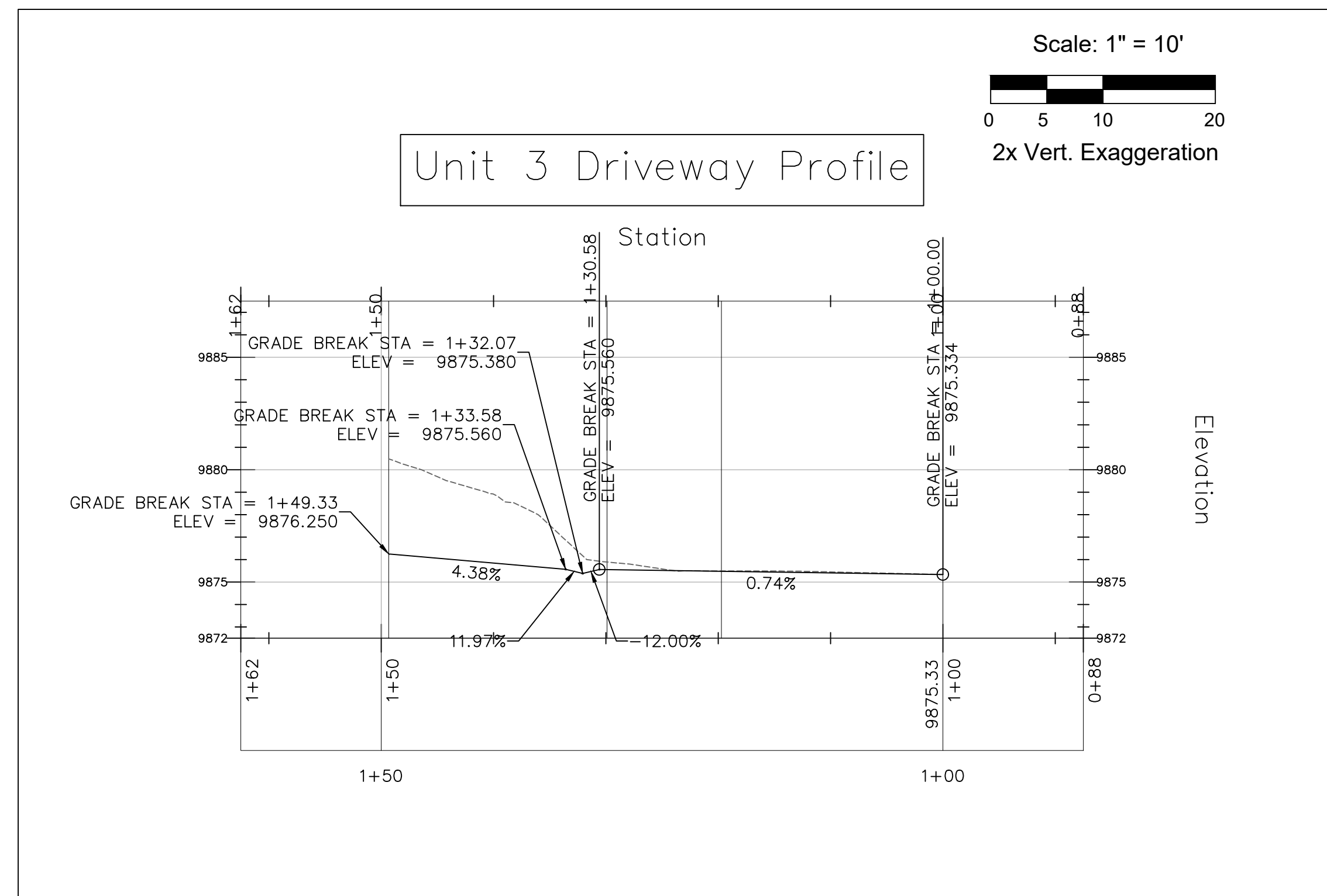
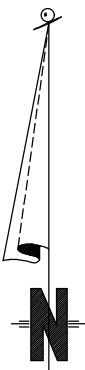
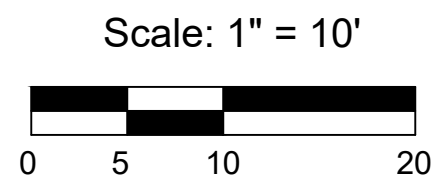
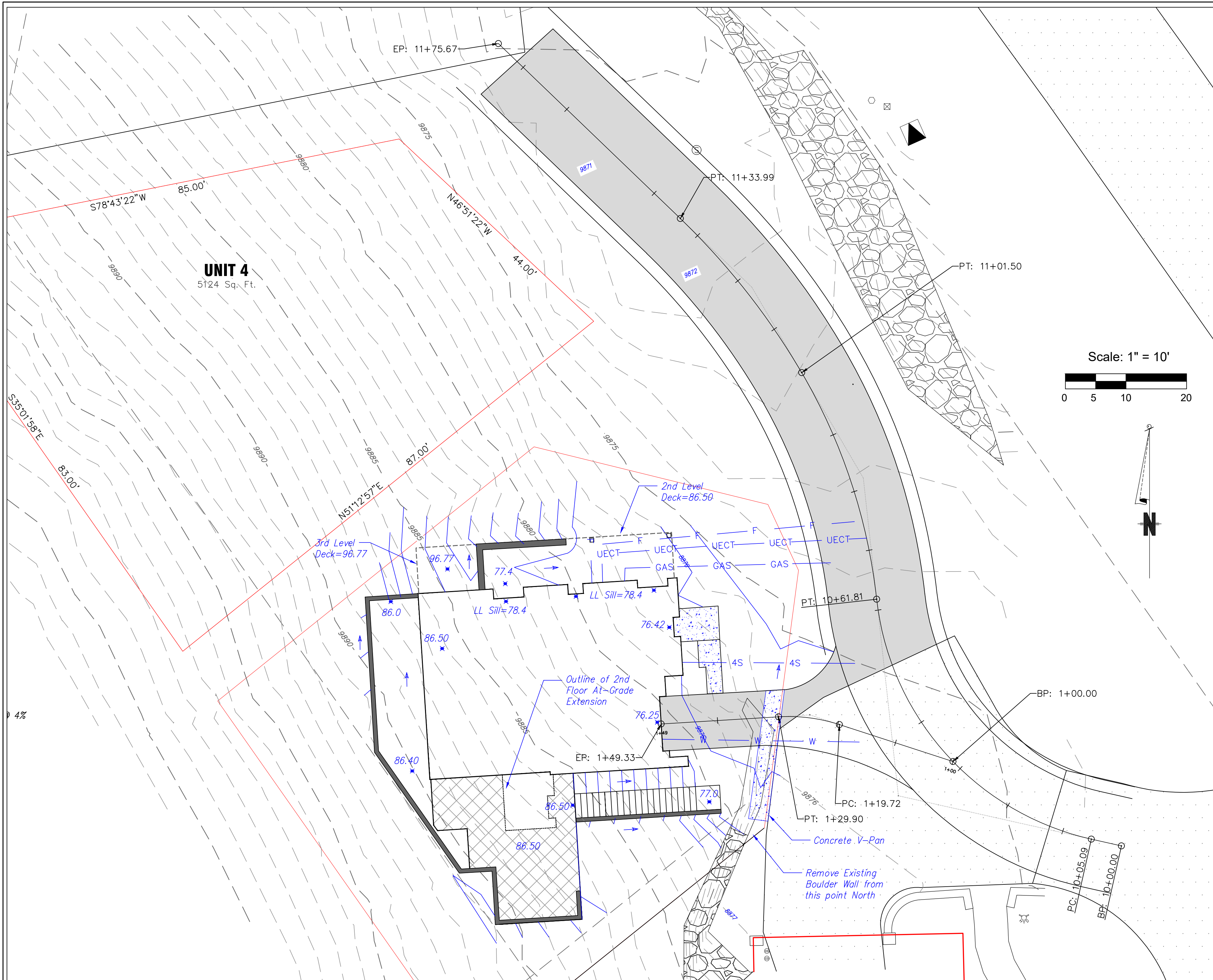

Main Access Profile

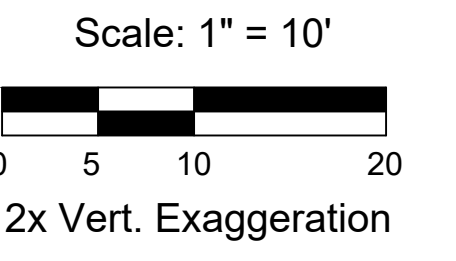
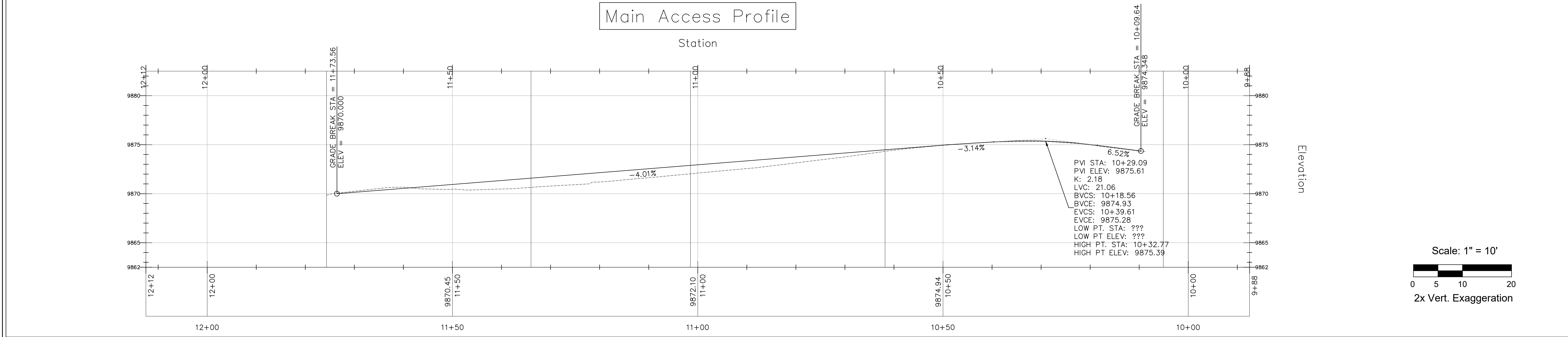

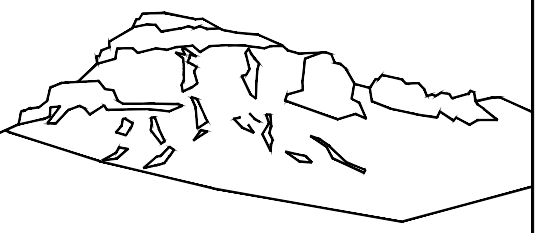

Uncompahgre
Engineering, LLC

P.O. Box 3945
Telluride, CO 81435
970-729-0683

SUBMISSIONS:
DRB Submittal 2021-02-01

162 San Joaquin
Unit 3
Mtn. Village, CO



CONTRACTOR TO REVIEW AND COMPARE ALL
CHAPTERS AND INTERDISCIPLINARY DRAWINGS
AND REPORT ANY DISCREPANCIES TO THE
ARCHITECT PRIOR TO ANY FIELD WORK BEING
DONE IN ACCORDANCE WITH AIA DOCUMENT A201

Utilities

C3

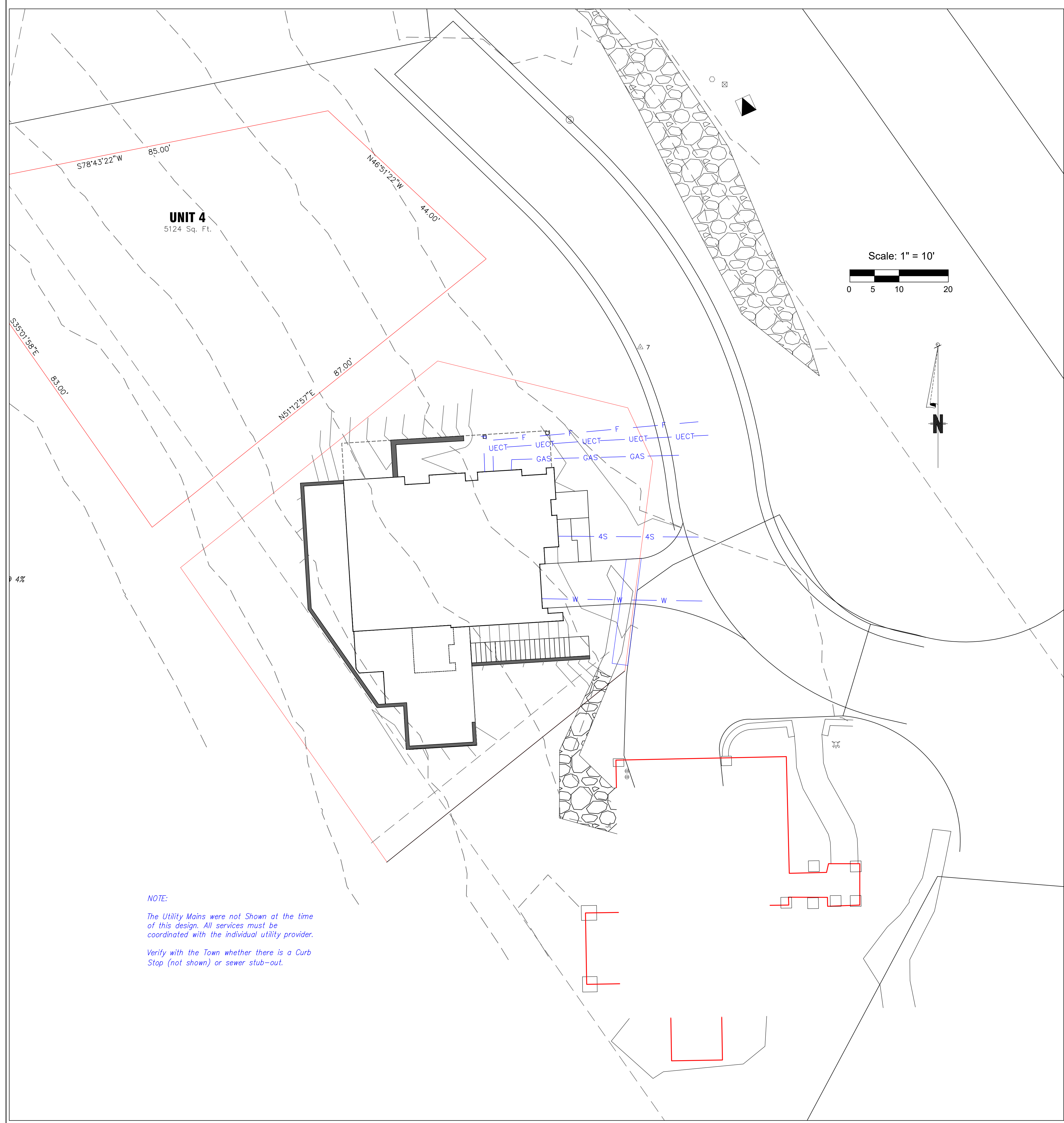

NOTE:
The Utility Mains were not Shown at the time
of this design. All services must be
coordinated with the individual utility provider.
Verify with the Town whether there is a Curb
Stop (not shown) or sewer stub-out.

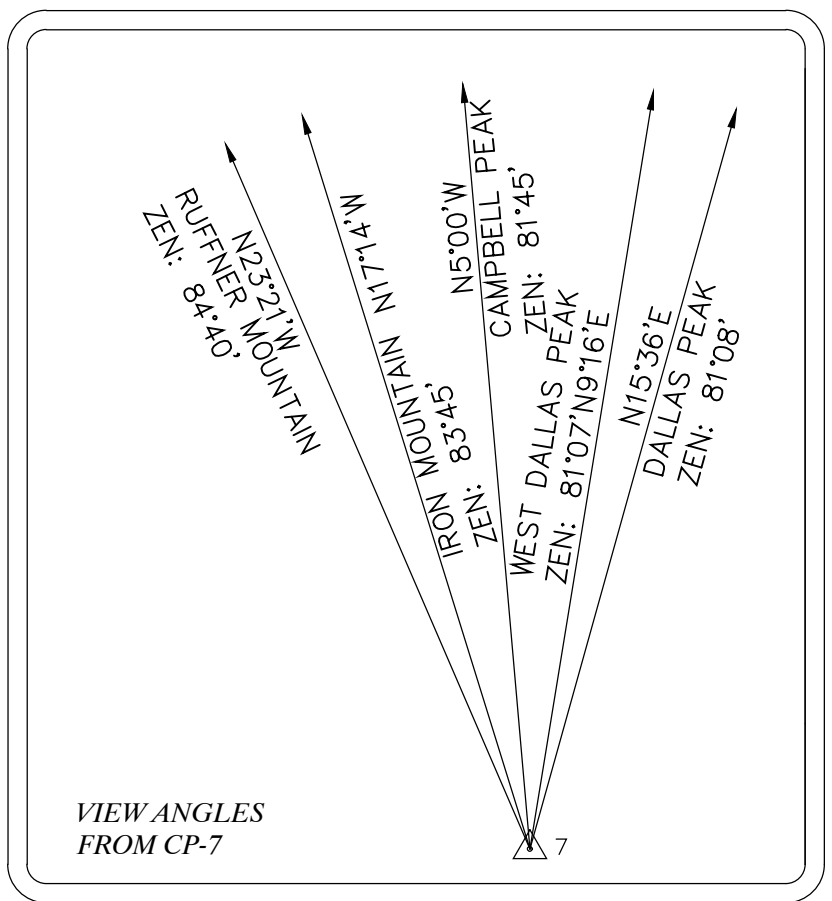
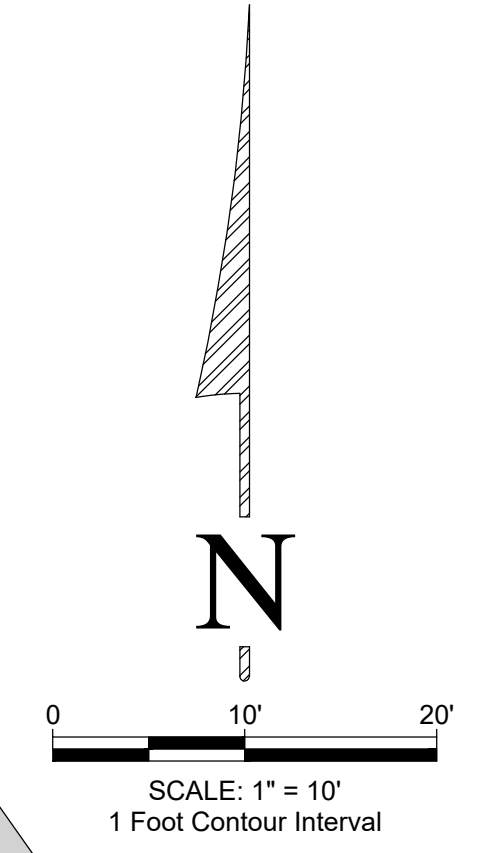
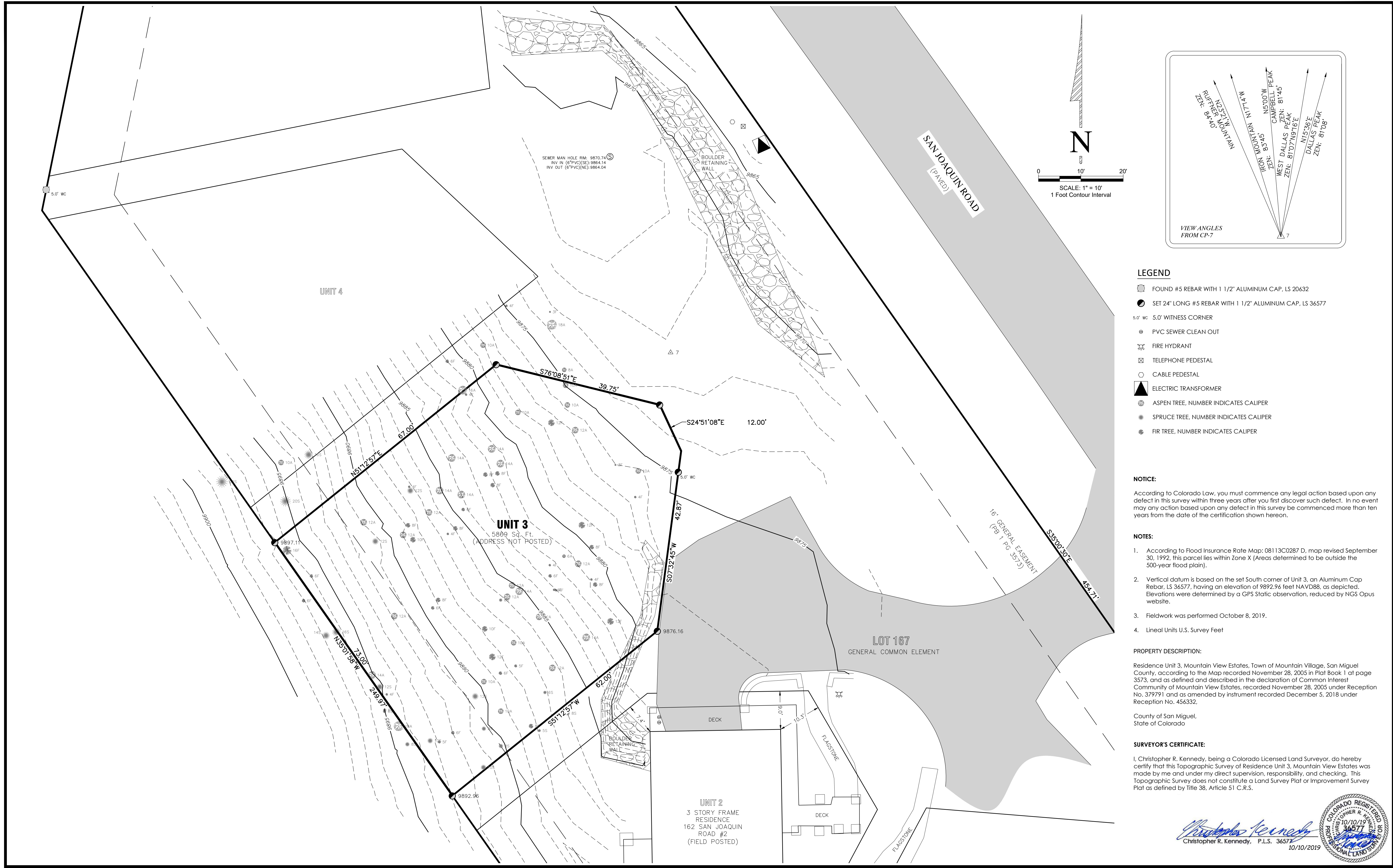

- LEGEND**
- FOUND #5 REBAR WITH 1 1/2" ALUMINUM CAP, LS 20632
 - SET 24" LONG #5 REBAR WITH 1 1/2" ALUMINUM CAP, LS 36577
 - 5.0' WC
 - PVC SEWER CLEAN OUT
 - ⊕ FIRE HYDRANT
 - ⊠ TELEPHONE PEDESTAL
 - CABLE PEDESTAL
 - ▲ ELECTRIC TRANSFORMER
 - ASPEN TREE, NUMBER INDICATES CALIPER
 - SPRUCE TREE, NUMBER INDICATES CALIPER
 - FIR TREE, NUMBER INDICATES CALIPER

NOTICE:
 According to Colorado Law, you must commence any legal action based upon any defect in this survey within three years after you first discover such defect. In no event may any action based upon any defect in this survey be commenced more than ten years from the date of the certification shown hereon.

- NOTES:**
1. According to Flood Insurance Rate Map: 08113C0287 D, map revised September 30, 1992, this parcel lies within Zone X (Areas determined to be outside the 500-year flood plain).
 2. Vertical datum is based on the set South corner of Unit 3, an Aluminum Cap Rebar, LS 36577, having an elevation of 9872.96 feet NAVD88, as depicted. Elevations were determined by a GPS Static observation, reduced by NGS Opus website.
 3. Fieldwork was performed October 8, 2019.
 4. Lineal Units U.S. Survey Feet

PROPERTY DESCRIPTION:
 Residence Unit 3, Mountain View Estates, Town of Mountain Village, San Miguel County, according to the Map recorded November 28, 2005 in Plat Book 1 at page 3573, and as defined and described in the declaration of Common Interest Community of Mountain View Estates, recorded November 28, 2005 under Reception No. 379791 and as amended by instrument recorded December 5, 2018 under Reception No. 456332.
 County of San Miguel,
 State of Colorado

SURVEYOR'S CERTIFICATE:
 I, Christopher R. Kennedy, being a Colorado Licensed Land Surveyor, do hereby certify that this Topographic Survey of Residence Unit 3, Mountain View Estates was made by me and under my direct supervision, responsibility, and checking. This Topographic Survey does not constitute a Land Survey Plat or Improvement Survey Plat as defined by Title 38, Article 51 C.R.S.

Christopher R. Kennedy
 Christopher R. Kennedy, P.L.S. 36577
 10/10/2019

TOPOGRAPHIC SURVEY
RESIDENCE UNIT 3, MOUNTAIN VIEW ESTATES, TOWN OF MOUNTAIN VILLAGE

SAN JUAN SURVEYING
 SURVEYING * PLANNING
 102 SOCIETY DRIVE TELLURIDE, CO. 81435
 (970) 728-1128 (970) 728-9201 fax
 office@sanjuansurveying.net

DATE:	10/08/2019
JOB:	19028
DRAWN BY:	ESS
CHECKED BY:	CRK
REVISION DATES:	
SHEET:	1 OF 1

CURVE TABLE					
CURVE #	ARC LENGTH	RADIUS	DELTA ANGLE	CHORD BEARING	CHORD LENGTH
C1	17.45	195.00	5°07'38"	S37°12'13"E	17.44
(C1)	17.50	195.00	5°08'31"	S37°34'45"E	17.49

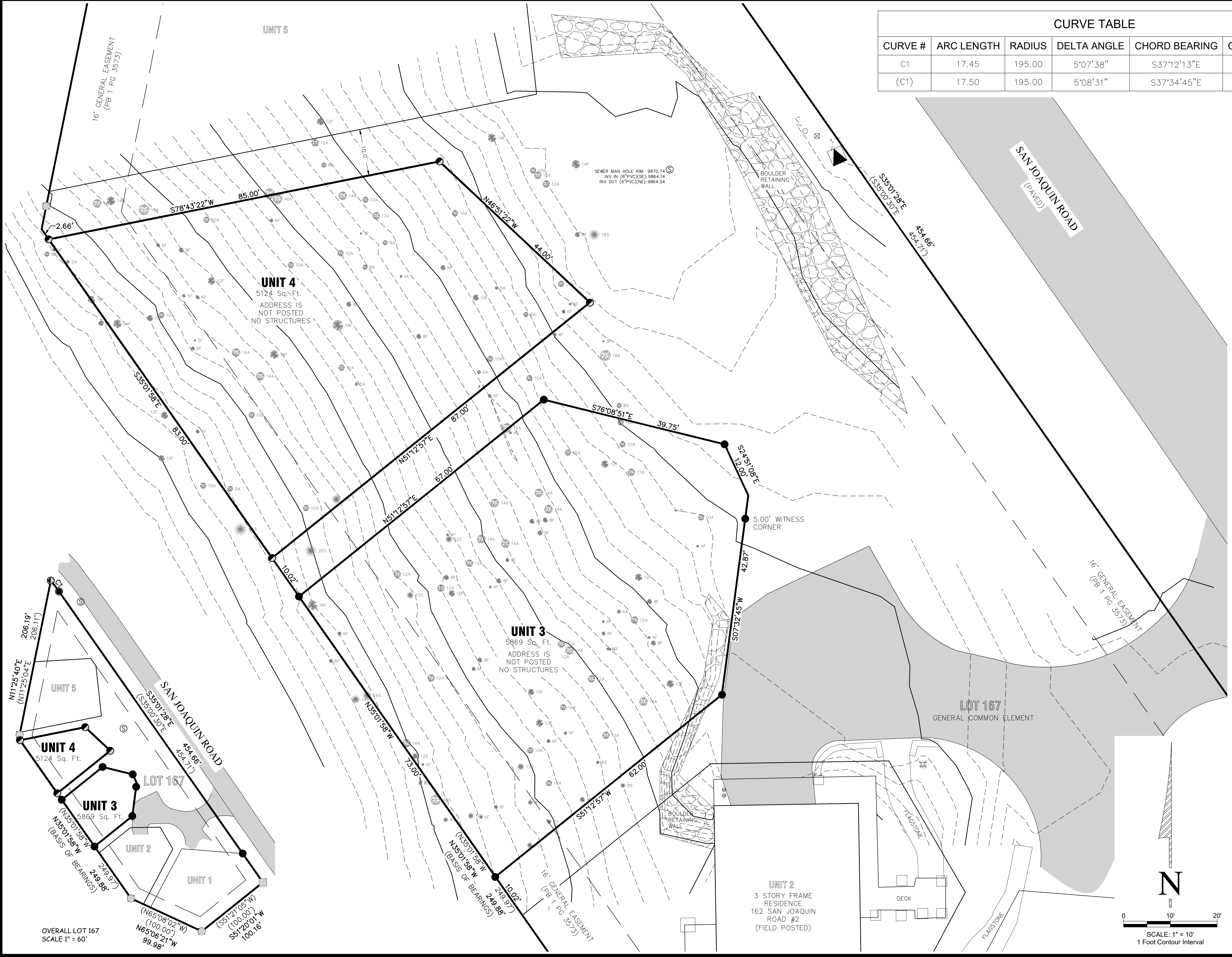
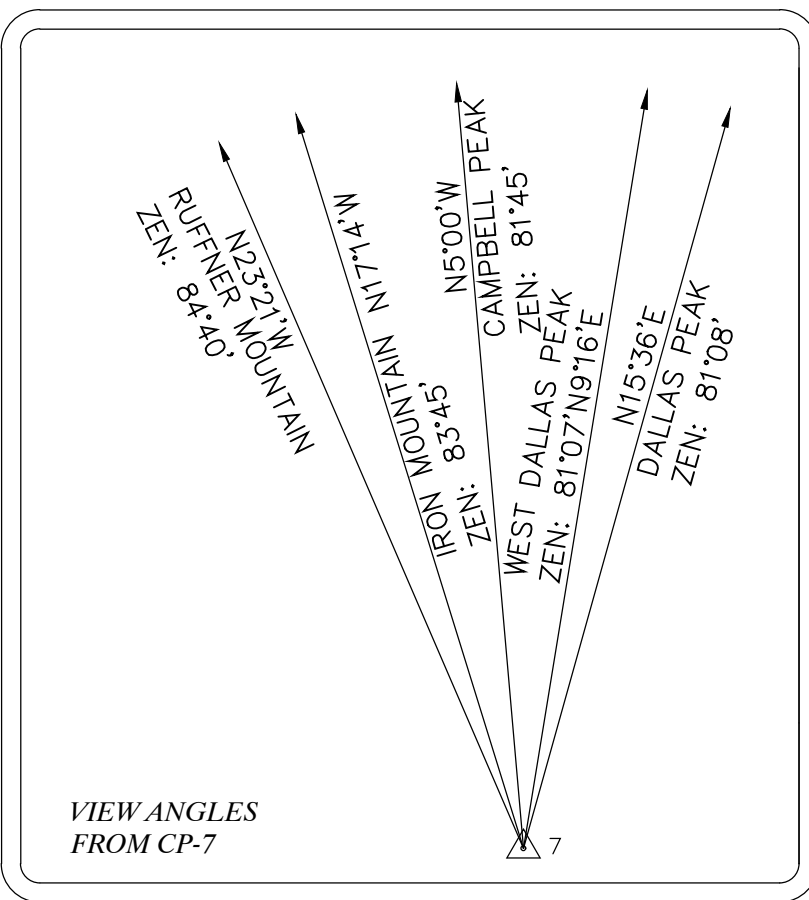

- LEGEND**
- FOUND #5 REBAR WITH 1 1/2" ALUMINUM CAP, LS 20632
 - SET 18" LONG #5 REBAR WITH 1 1/2" ALUMINUM CAP, LS 36577
 - FOUND #5 REBAR WITH 1 1/2" ALUMINUM CAP, LS 24963
 - FOUND #5 REBAR WITH 1 1/2" ALUMINUM CAP, LS 36577
 - PVC SEWER CLEAN OUT
 - ⊕ FIRE HYDRANT
 - ⊗ TELEPHONE PEDESTAL
 - CABLE PEDESTAL
 - ▲ ELECTRIC TRANSFORMER
 - ⊙ ASPEN TREE, NUMBER INDICATES CALIPER
 - SPRUCE TREE, NUMBER INDICATES CALIPER
 - FIR TREE, NUMBER INDICATES CALIPER

NOTICE:
According to Colorado Law, you must commence any legal action based upon any defect in this survey within three years after you first discover such defect. In no event may any action based upon any defect in this survey be commenced more than ten years from the date of the certification shown hereon.

- NOTES:**
- According to Flood Insurance Rate Map: 08113C0287 D, map revised September 30, 1992, this parcel lies within Zone X (Areas determined to be outside the 500-year flood plain).
 - Easement research from Land Title Guarantee Company, Policy No. ox8610066.2841430, Policy Date September 18, 2020 at 05:00 PM.
 - Vertical datum is based on the set South corner of Unit 3, an Aluminum Cap Rebar, LS 36577, having an elevation of 9892.96 feet NAVD88, as depicted. Elevations were determined by a GPS Static observation, reduced by NGS Opus website.
 - Lineal Units U.S. Survey Feet

PROPERTY DESCRIPTION:
Airspace Unit 4, Mountain View Estates, Town of Mountain Village, San Miguel County, according to the Map recorded November 28, 2005 in Plat Book 1 at page 3573, and as defined and described in the declaration of Common Interest Community of Mountain View Estates, recorded November 28, 2005 under Reception No. 379791 and as amended by instrument recorded December 5, 2018 under Reception No. 456332, and as amended by instrument recorded August 15, 2020 under Reception No. 464457
County of San Miguel,
State of Colorado
Airspace Unit 3, Mountain View Estates, Town of Mountain Village, San Miguel County, according to the Map recorded November 28, 2005 in Plat Book 1 at page 3573, and as defined and described in the declaration of Common Interest Community of Mountain View Estates, recorded November 28, 2005 under Reception No. 379791 and as amended by instrument recorded December 5, 2018 under Reception No. 456332, and as amended by instrument recorded August 15, 2020 under Reception No. 464457
County of San Miguel,
State of Colorado

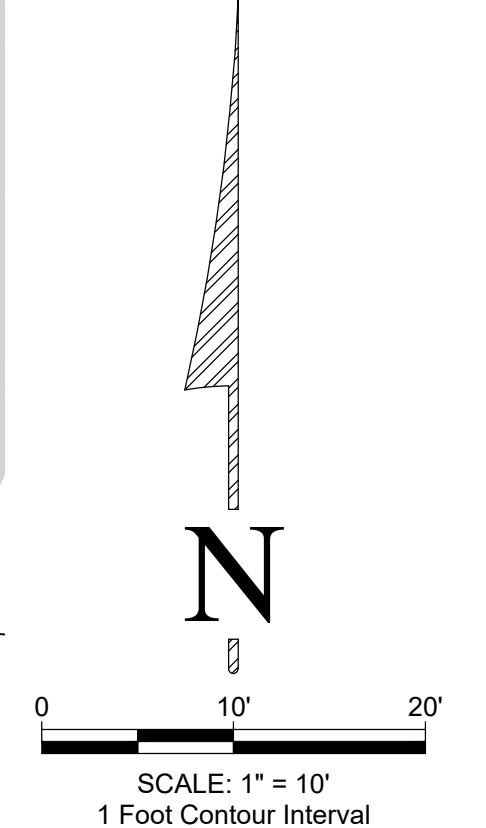

Christopher R. Kennedy
Christopher R. Kennedy, P.L.S. 36577
02/10/2021
COLORADO REGISTERED PROFESSIONAL LAND SURVEYOR

IMPROVEMENT SURVEY PLAT

AIRSPACE UNITS 3 & 4, MOUNTAIN VIEW ESTATES, TOWN OF MOUNTAIN VILLAGE

SAN JUAN SURVEYING
SURVEYING * PLANNING
102 SOCIETY DRIVE TELLURIDE, CO. 81435
(970) 728-1128 (970) 728-9201 fax
office@sanjuansurveying.net

DATE:	02/10/2021
JOB:	19028
DRAWN BY:	CRK
CHECKED BY:	KSK
REVISION DATES:	
SHEET:	1 OF 1

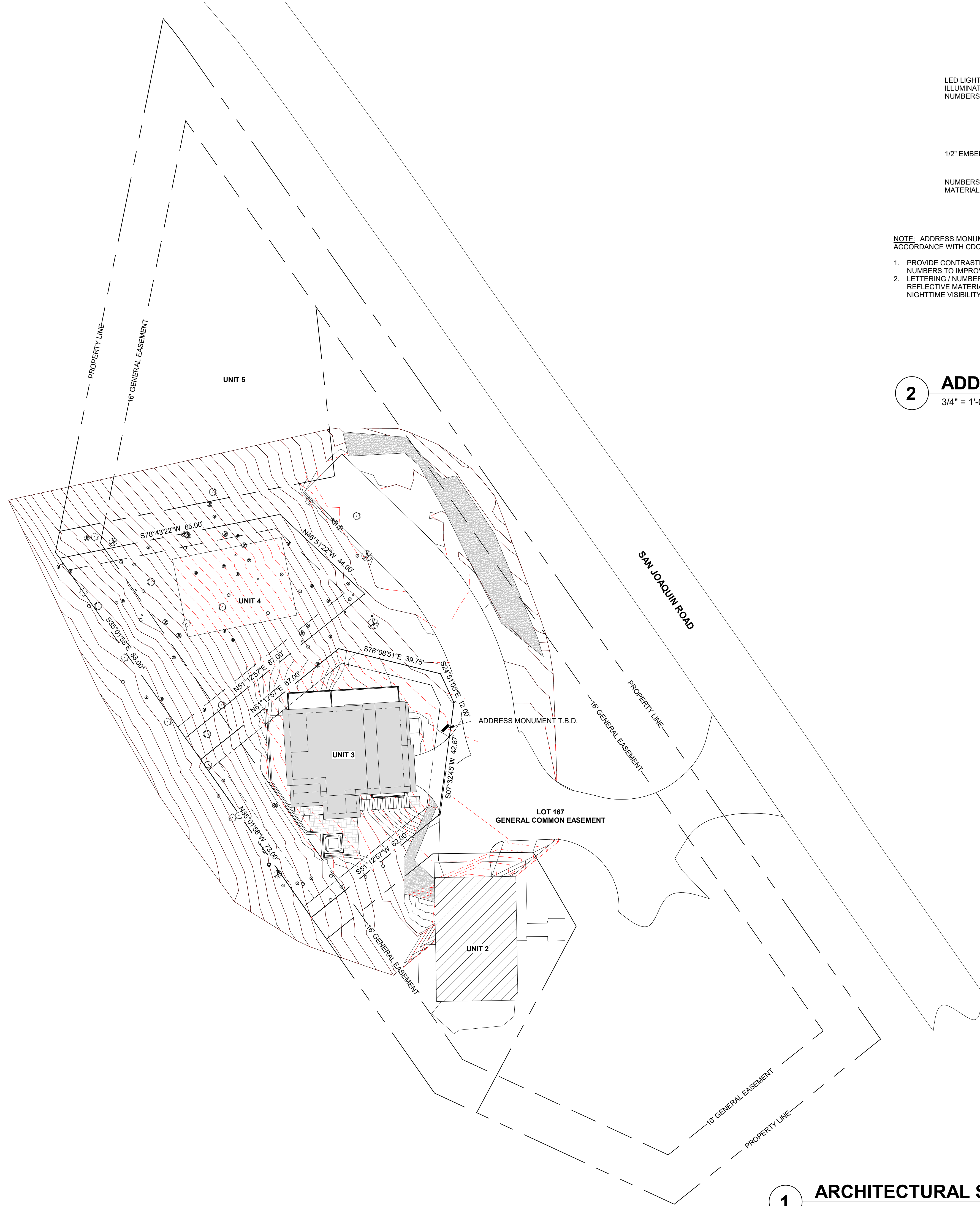

1 ARCHITECTURAL SITE PLAN
1" = 20'-0"

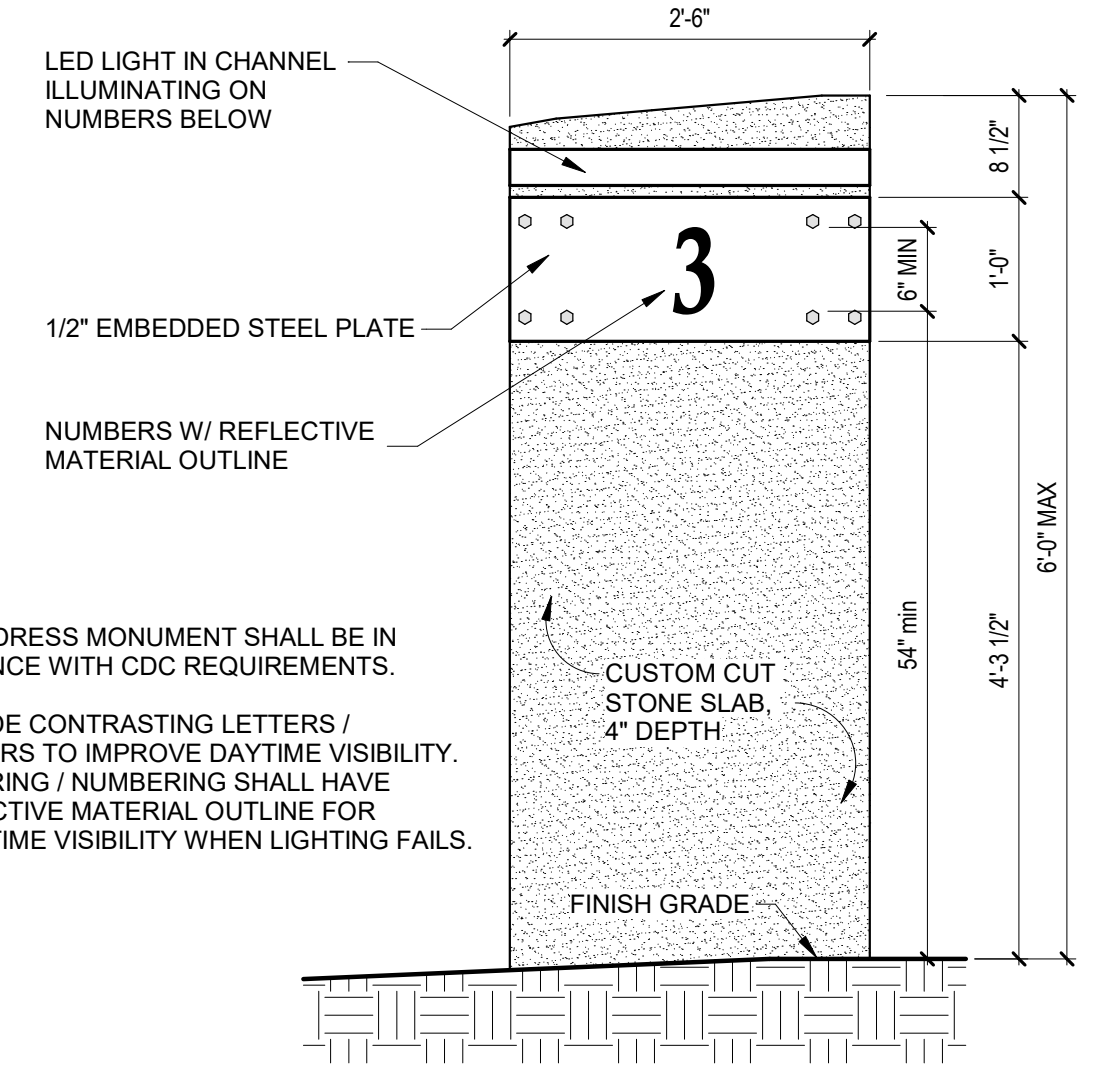

- NOTE:** ADDRESS MONUMENT SHALL BE IN ACCORDANCE WITH CDC REQUIREMENTS.
1. PROVIDE CONTRASTING LETTERS / NUMBERS TO IMPROVE DAYTIME VISIBILITY.
 2. LETTERING / NUMBERING SHALL HAVE REFLECTIVE MATERIAL OUTLINE FOR NIGHTTIME VISIBILITY WHEN LIGHTING FAILS.

2 ADDRESS MONUMENT ELEVATION
3/4" = 1'-0"

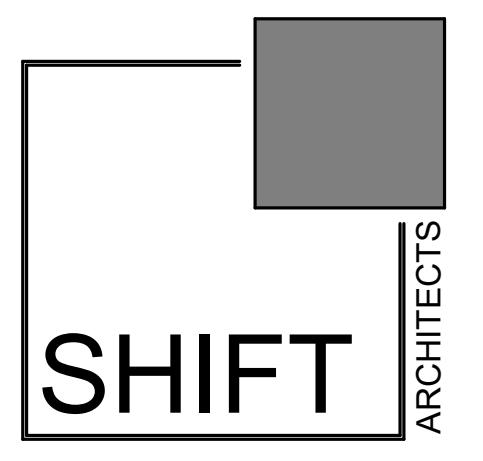

P.O. Box 3206
100 W. Colorado Suite 211
Telluride, Colorado 81435
p 970-728-8145
kristine@shift-architects.com
www.shift-architects.com

PROJECT ISSUE DATE:
02.01.21 DRB PRELIMINARY SUBMITTAL

REVISIONS

NO.	DATE	DESC.

MOUNTAIN VIEW ESTATES UNIT 3

162 SAN JOAQUIN RD. 3, MOUNTAIN VILLAGE, CO 81435
UNIT 3 MOUNTAIN VIEW ESTATES, TOWN OF MOUNTAIN VILLAGE, SAN MIGUEL COUNTY, ACCORDING TO THE MAP RECORDED NOVEMBER 28, 2005 IN PLAT BOOK 1 AT PAGE 3573, AND AS DEFINED AND DESCRIBED IN THE DECLARATION OF COMMON INTEREST COMMUNITY FOR MOUNTAIN VIEW ESTATES, RECORDED NOVEMBER 28, 2005 UNDER RECEPTION NO. 378791, AND AS AMENDED BY INSTRUMENT RECORDED DECEMBER 5, 2018 UNDER RECEPTION NO. 456632, COUNTY OF SAN MIGUEL, STATE OF COLORADO.

ARCHITECTURAL
SITE PLAN

SHEET NUMBER

A1.1

NOT FOR CONSTRUCTION

©shift architects

2/3/2021 9:23:10 AM

MOUNTAIN VIEW ESTATES UNIT 3

162 SAN JOAQUIN RD. 3, MOUNTAIN VILLAGE, CO 81435
 UNIT 3 MOUNTAIN VIEW ESTATES, TOWN OF MOUNTAIN VILLAGE, SAN MIGUEL COUNTY, ACCORDING TO THE MAP RECORDED NOVEMBER 28, 2005 IN
 PLAT BOOK 1 AT PAGE 3573, AND AS DEFINED AND DESCRIBED IN THE DECLARATION OF COMMON INTEREST COMMUNITY FOR MOUNTAIN VIEW
 ESTATES, RECORDED NOVEMBER 28, 2005 UNDER RECEPTION NO. 379791 AND AS AMENDED BY INSTRUMENT RECORDED DECEMBER 5, 2018 UNDER
 RECEPTION NO. 456632, COUNTY OF SAN MIGUEL, STATE OF COLORADO.

BUILDING SITE PLAN

SHEET NUMBER

A1.2

©shift architects

NOT FOR CONSTRUCTION

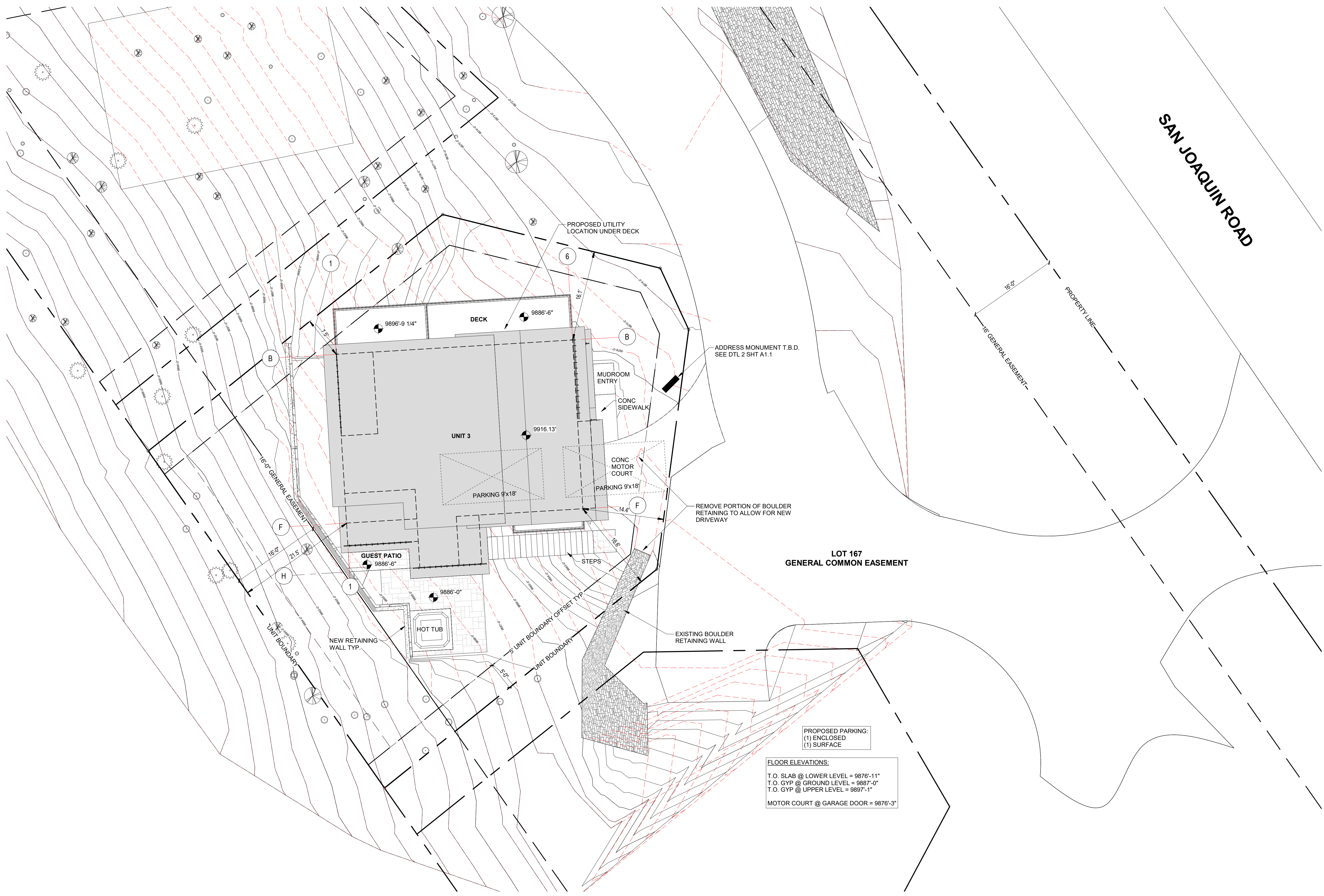

PROPOSED PARKING:
 (1) ENCLOSED
 (1) SURFACE

FLOOR ELEVATIONS:
 T.O. SLAB @ LOWER LEVEL = 9876'-11"
 T.O. GYP @ GROUND LEVEL = 9887'-0"
 T.O. GYP @ UPPER LEVEL = 9897'-1"
 MOTOR COURT @ GARAGE DOOR = 9876'-3"

1 BUILDING SITE PLAN
 1/8" = 1'-0"

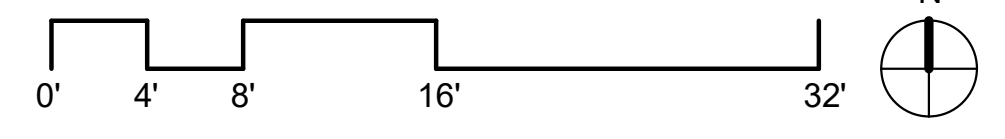

2/3/2021 9:23:11 AM

PLANT SCHEDULE			
BOTANICAL NAME	COMMON NAME	SIZE	QTY
POPULUS TREMULOIDES	QUAKING ASPEN	3" CAL. DBH	7
PICEA	SPRUCE	8-10 FT IN HT W/ 10% 30 FT OR LARGER	N/A
SHRUBS		5 GAL.	N/A
PERENNIALS - BED A			N/A
PERENNIALS - BED B			N/A

WATER USAGE CHART			
TYPE	MONTHLY USE	TOTAL #	TOTAL MONTHLY USAGE
REVEGETATION	2/ GAL S.F.	2,109	4,218 (FIRST SEASON)
PERENNIALS	4/ S.F.	N/A	N/A
ASPENS	10 GAL	7	70
NATIVE SHRUBS	5 GAL	N/A	N/A
COMPLETE MONTHLY USAGE (FOR ESTABLISHMENT)			4,288 GAL
(POST ESTABLISHMENT)			70 GAL

- ### IRRIGATION NOTES
- TAP WITH RAINBIRD PVB-075 BACKFLOW PREVENTER.
 - RAINBIRD RCM-12 ELECTROMECHANICAL CONTROLLER.
 - 1.5" WILKINS MODEL 500 PRESSURE REGULATOR.
 - RAINBIRD 150-PEB 1.5" ELECTRIC REMOTE CONTROL VALVE.
 - CLASS 200 PVC MAINLINE 1 1/2".
 - 1" 80NSF POLYLATERAL LINE.
 - WATER SENSOR BY RAINBIRD.

IRRIGATION SCHEDULE			
ZONE	LOCATION	HEAD	GPM
1	ASPEN TREES	DRIP EMITTERS	-
1	EVERGREEN TREES	DRIP EMITTERS	-
2	SHRUBS	DRIP EMITTERS	-
3	PERENNIALS	1806 POP UPS	-
4	REVEGETATION AREAS	ROTORS	24

- ### GENERAL NOTES:
- ALL TREES AND SHRUBS TO BE LOCATED BY PROJECT ARCHITECT / OWNER.
 - ALL TREES AND SHRUBS SHALL BE BACKED FILLED WITH A TOPSOIL / ORGANIC FERTILIZER MIXTURE AT A 2:1 RATIO.
 - NECESSARY TREES SHALL BE STAKED WITH 4" METAL POSTS. TREES SHALL BE GUYED WITH 12 GAUGE GALVANIZED WIRE AND POLYPROPYLENE TREE RACE STRIPS.
 - PERENNIAL PLANTING BEDS SHALL BE TILLED 6" DEPTH AND AMENDED WITH TOPSOIL AND ORGANIC FERTILIZER AT A 2:1 RATIO.
 - SEE PLANTING DETAILS FOR ALL DECIDUOUS AND EVERGREEN TREES.
 - MULCH ALL PERENNIAL BEDS WITH A PINE BARK SOIL CONDITIONER BY SOUTHWEST IMPORTERS; SHREDDED CEDAR BARK.
 - ALL PLANT MATERIAL TO MEET THE AMERICAN STANDARD FOR NURSERY STOCK.
 - LANDSCAPING AND TREE REMOVAL SHALL BE IN ACCORDANCE WITH CDC 17.5.9 LANDSCAPING REGULATIONS AND CDC 17.6.1 ENVIRONMENTAL REGULATIONS.
- NOXIOUS WEEDS:**
- ALL PLANTED MATERIALS INCLUDING SEEDS, SHALL BE NON NOXIOUS SPECIES AS SPECIFIED IN THE NOXIOUS WEED CDC TABLE 5-5 OR SUBSEQUENTLY DESIGNATED AS A NOXIOUS WEED BY THE STATE OF COLORADO, OR THE TOWN.
- LANDSCAPE MAINTENANCE NOTES:**
- TURF SHALL BE AERATED 2 TO 3 TIMES PER YEAR TO INCREASE THE WATER ABSORPTION RATE. NECESSARY ORGANIC FERTILIZATION AND AMENDMENT SHALL BE INCORPORATED AT THE SAME TIME.
 - NECESSARY ORGANIC FERTILIZERS AND AMENDMENT SHALL BE ADDED TO PERENNIAL BEDS SEASONALLY ALONG WITH MULCH.
 - ALL SHRUBS IN SNOW SHED AREAS TO BE CUT BACK IN FALL TO 12"-18" IN HEIGHT.
 - IRRIGATION SYSTEM TO BE BLOWN OUT BY OCTOBER 31ST EACH FALL AND TURNED ON BY JUNE 1ST EACH SPRING.
- ### REVEGETATION NOTES:
- SUBSOIL SURFACE SHALL BE TILLED TO A 4" DEPTH ON NON FILL AREAS.
 - TOPSOIL SHALL BE SPREAD AT A MINIMUM DEPTH OF 4" OVER ALL AREAS TO BE REEMITTED (EXCEPT ON SLOPES GREATER THAN 3:1) AND AMENDMENTS ROTOTILLED AT A RATE OF THREE CUBIC YARDS PER THOUSAND SQUARE FEET.
 - BROADCASTING OF SEED SHALL BE DONE IMMEDIATELY AFTER TOPSOIL IS APPLIED (WITHIN 10 DAYS) TO MINIMIZE EROSION AND WEEDS.
 - AREAS WHICH HAVE BEEN COMPACTED OR ARE RELATIVELY UNDISTURBED NEEDING SEEDING, SHALL BE SCARIFIED BEFORE BROADCASTING OF SEED.
 - BROADCASTING WITH SPECIFIED SEED MIX AND FOLLOW WITH DRY MULCHING, STRAW OR HAY SHALL BE UNIFORMLY APPLIED OVER SEEDED AREA AT A RATE OF 1.5 TONS PER ACRE FOR HAY OR 2 TONS PER ACRE FOR STRAW, CRIMP IN.
 - ON SLOPES GREATER THAN 3:1 EROSION CONTROL BLANKET SHALL BE APPLIED IN PLACE OF STRAW MULCH AND PINNED.
 - ALL UTILITY CUTS SHALL BE REVEGETATED WITHIN TWO WEEKS AFTER INSTALLATION OF UTILITIES TO PREVENT WEED INFESTATION.
 - SEED ALL AREAS LABELED NATIVE GRASS SEED WITH THE FOLLOWING MIXTURE AT A RATE OF 12 LBS. PER ACRE.
- | SPECIES | PURE LIVE SEED PER ACRE |
|---------------------|-------------------------|
| WESTERN YARROW | 5% |
| TALL FESCUE | 10% |
| ARIZONA FESCUE | 5% |
| HARD FESCUE | 5% |
| CREeping RED FESCUE | 10% |
| ALPINE BLUEGRASS | 15% |
| CANADA BLUEGRASS | 10% |
| PERENNIAL RYEGRASS | 15% |
| SLENDER WHEATGRASS | 10% |
| MOUNTAIN BROME | 15% |

LEGEND

	CONCRETE PAVERS		INDIGENOUS SHRUBS
	WILDFIRE MITIGATION BOUNDARY		EXISTING ASPEN TREE
	LIMIT OF DISTURBANCE		EXISTING ASPEN TREE TO BE REMOVED
	METAL GATE TO MATCH FENCE		NEW ASPEN TREE
	TREE PROTECTION FENCING		EXISTING EVERGREEN TREE
	REVEGETATE W/ NATIVE GRASS		EXISTING EVERGREEN TREE TO BE REMOVED
	DISTURBED AREAS		NEW EVERGREEN TREE
	MULCH LANDSCAPE BEDDING		
	PERENNIAL BEDDING		
	FLAGSTONE		
	STONE PAVER		
	SNOW MELT AREAS		

NOTE:
ALL EXISTING TREES TO BE PROTECTED THROUGHOUT CONSTRUCTION.

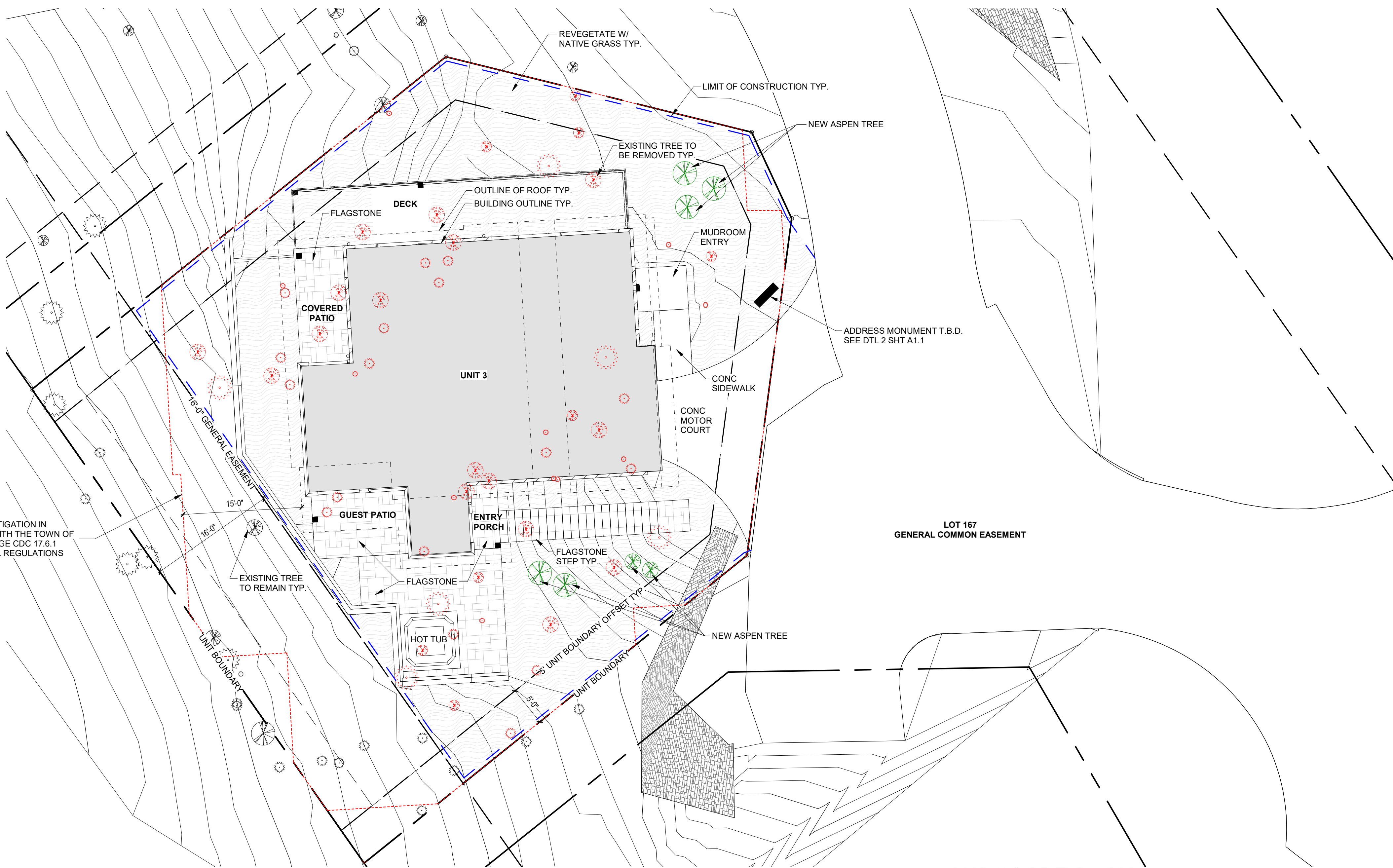

1 LANDSCAPE PLAN
1/8" = 1'-0"

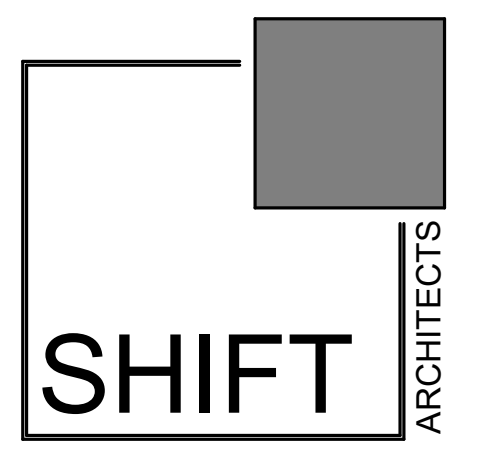
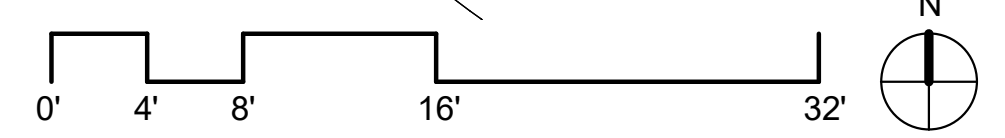

P.O. Box 3206
100 W. Colorado Suite 211
Telluride, Colorado 81435
p 970-728-8145
kristine@shift-architects.com
www.shift-architects.com

PROJECT ISSUE DATE:
02.01.21 DRB PRELIMINARY
SUBMITTAL

REVISIONS
NO. DATE DESC.

MOUNTAIN VIEW ESTATES UNIT 3
162 SAN JOAQUIN RD. 3, MOUNTAIN VILLAGE, CO 81435
UNIT 3 MOUNTAIN VIEW ESTATES, TOWN OF MOUNTAIN VILLAGE, SAN MIGUEL COUNTY, ACCORDING TO THE MAP RECORDED NOVEMBER 28, 2005 IN
PLAY BOOK 1 AT PAGE 3573, AND AS DEFINED AND DESCRIBED IN THE DECLARATION OF COMMON INTEREST COMMUNITY FOR MOUNTAIN VIEW
ESTATES, RECORDED NOVEMBER 28, 2005 UNDER RECEPTION NO. 379791 AND AS AMENDED BY INSTRUMENT RECORDED DECEMBER 5, 2018 UNDER
RECEPTION NO. 456632, COUNTY OF SAN MIGUEL, STATE OF COLORADO.

LANDSCAPE PLAN

SHEET NUMBER

A1.3

2/3/2021 9:23:12 AM

NOT FOR CONSTRUCTION

©shift architects



CONSTRUCTION MITIGATION LEGEND

	LIMITS OF CONSTRUCTION		EXISTING ASPEN TREE TO REMAIN
	TEMPORARY PARKING		EXISTING EVERGREEN TREE TO REMAIN
	REVEGETATION AREAS		
	CONSTRUCTION FENCING		
	TREE PROTECTION FENCING		

- ALL DEVELOPMENT SHALL COMPLY WITH CDC CONSTRUCTION MITIGATION REGULATIONS.
- COORDINATE LOCATION OF PORTA TOILET, TRASH, RECYCLE, MATERIAL STORAGE AND PARKING WITH THE TOWN OF MOUNTAIN VILLAGE.
- ALL EXISTING TREES TO BE PROTECTED THROUGHOUT CONSTRUCTION.

SHIFT ARCHITECTS

P.O. Box 3206
 100 W. Colorado Suite 211
 Telluride, Colorado 81435
 p 970-728-8145
 kristine@shift-architects.com
 www.shift-architects.com

PROJECT ISSUE DATE:
 02.01.21 DRB PRELIMINARY SUBMITTAL

REVISIONS

NO.	DATE	DESC.
-----	------	-------

MOUNTAIN VIEW ESTATES UNIT 3

162 SAN JOAQUIN RD. 3, MOUNTAIN VILLAGE, CO 81435
 UNIT 3 MOUNTAIN VIEW ESTATES, TOWN OF MOUNTAIN VILLAGE, SAN MIGUEL COUNTY, ACCORDING TO THE MAP RECORDED NOVEMBER 28, 2005 IN PLAT BOOK 1 AT PAGE 3573, AND AS DEFINED AND DESCRIBED IN THE DECLARATION OF COMMON INTEREST COMMUNITY FOR MOUNTAIN VIEW ESTATES, RECORDED NOVEMBER 28, 2005 UNDER RECEPTION NO. 379791 AND AS AMENDED BY INSTRUMENT RECORDED DECEMBER 5, 2018 UNDER RECEPTION NO. 4566332, COUNTY OF SAN MIGUEL, STATE OF COLORADO.

CONSTRUCTION MITIGATION PLAN

SHEET NUMBER

1 CONSTRUCTION MITIGATION PLAN
 1/8" = 1'-0"

0' 4' 8' 16' 32'

2/3/2021 9:23:12 AM

A1.4

NOT FOR CONSTRUCTION

©shift architects

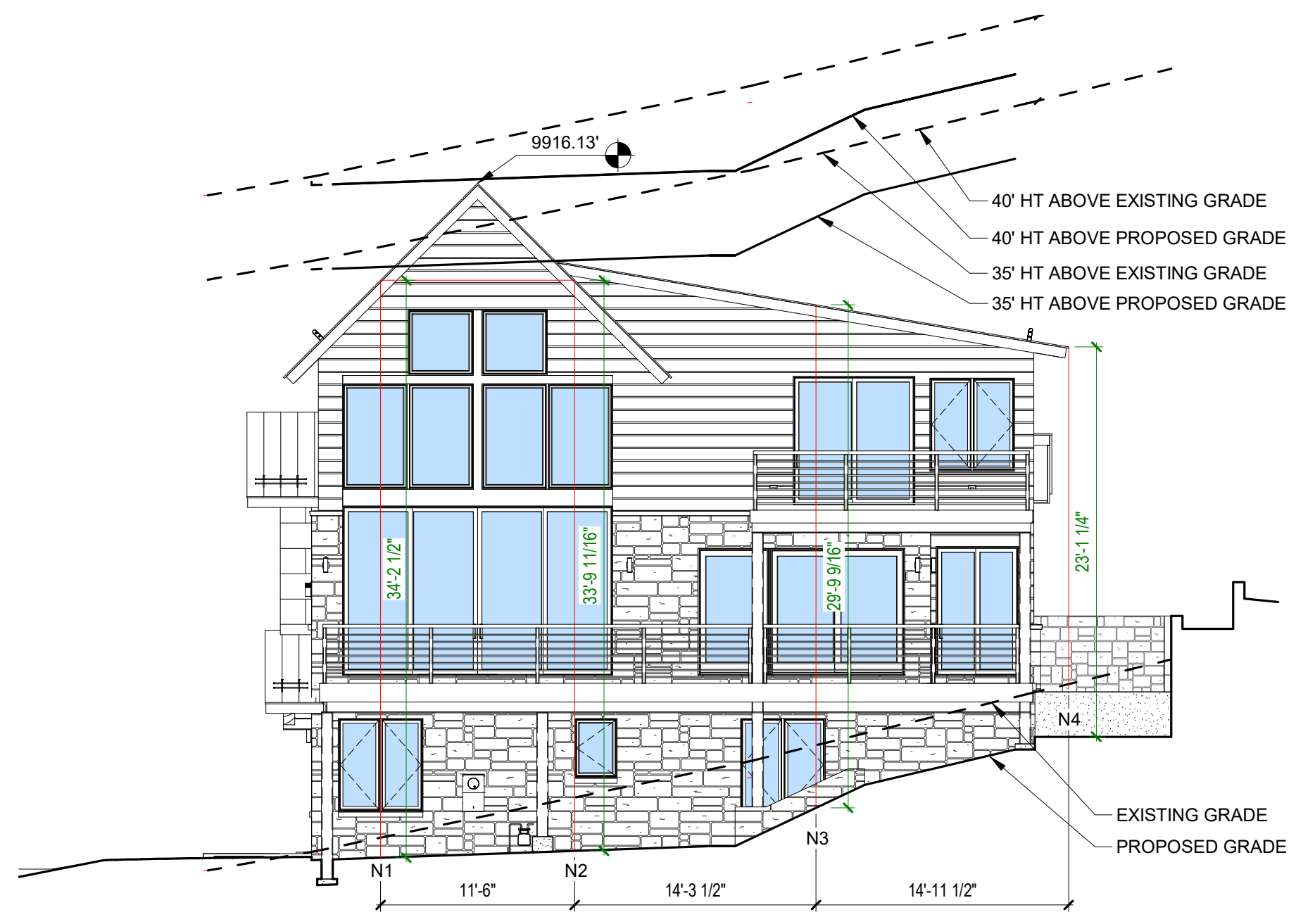

1 NORTH ELEVATION
1/8" = 1'-0"

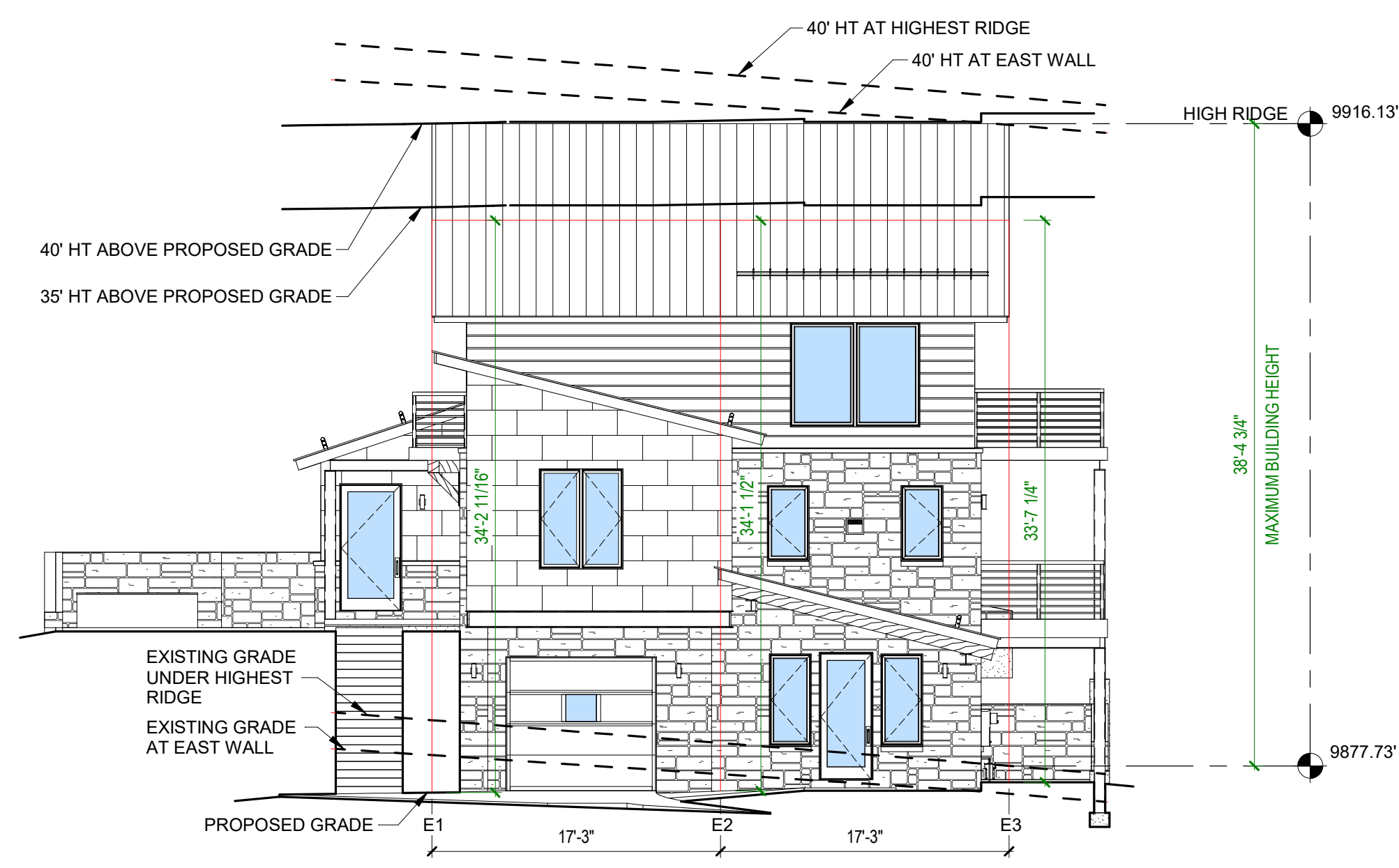

2 EAST ELEVATION
1/8" = 1'-0"

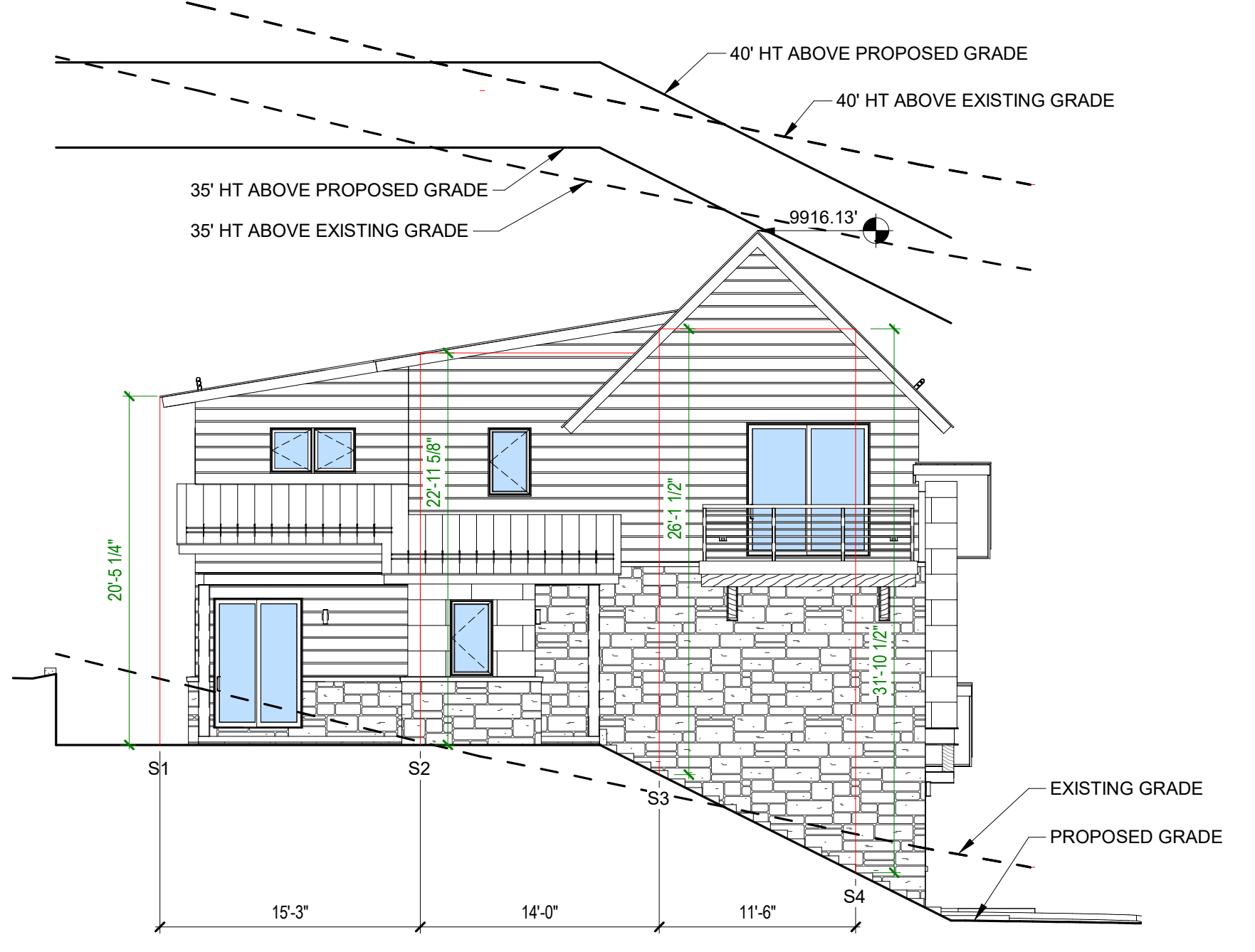

3 SOUTH ELEVATION
1/8" = 1'-0"

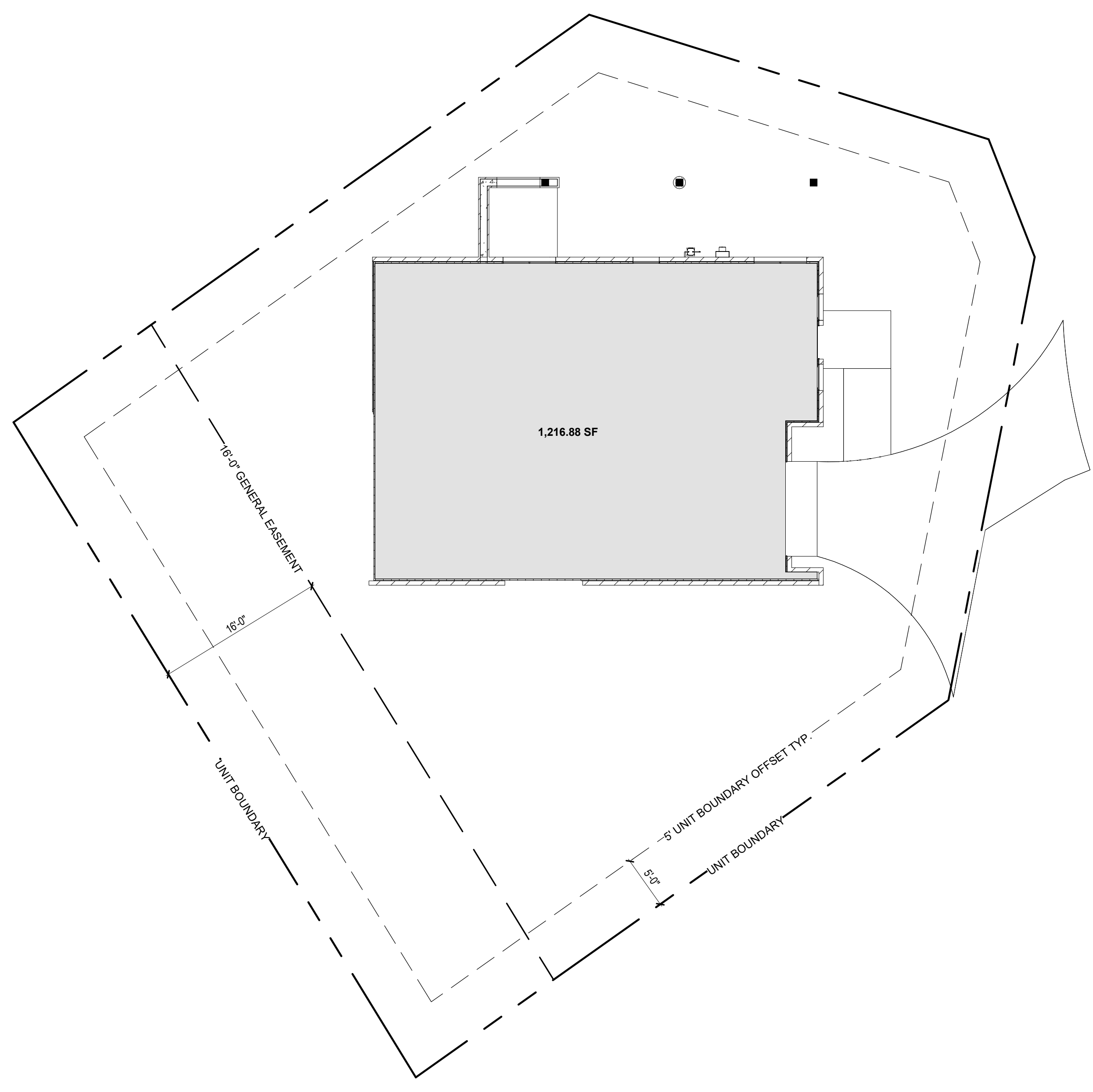

5 MAXIMUM RESIDENCE BUILDING FOOTPRINT
1/8" = 1'-0"

AVG ROOF HT :

NORTH ELEVATION	
N1	34'-2 1/2"
N2	33'-9 11/16"
N3	29'-9 9/16"
N4	20'-3 1/4"
SOUTH ELEVATION	
S1	20'-5 1/4"
S2	22'-11 5/8"
S3	26'-1 1/2"
S4	31'-10 1/2"
EAST ELEVATION	
E1	34'-2 11/16"
E2	34'-1 1/2"
E3	33'-7 1/4"
WEST ELEVATION	
W1	26'-7 3/8"
W2	22'-11 1/8"
W3	22'-11 1/4"
TOTAL:	22'-11 1/4"
NUMBER OF LOCATIONS:	14
AVERAGE:	28'-1"

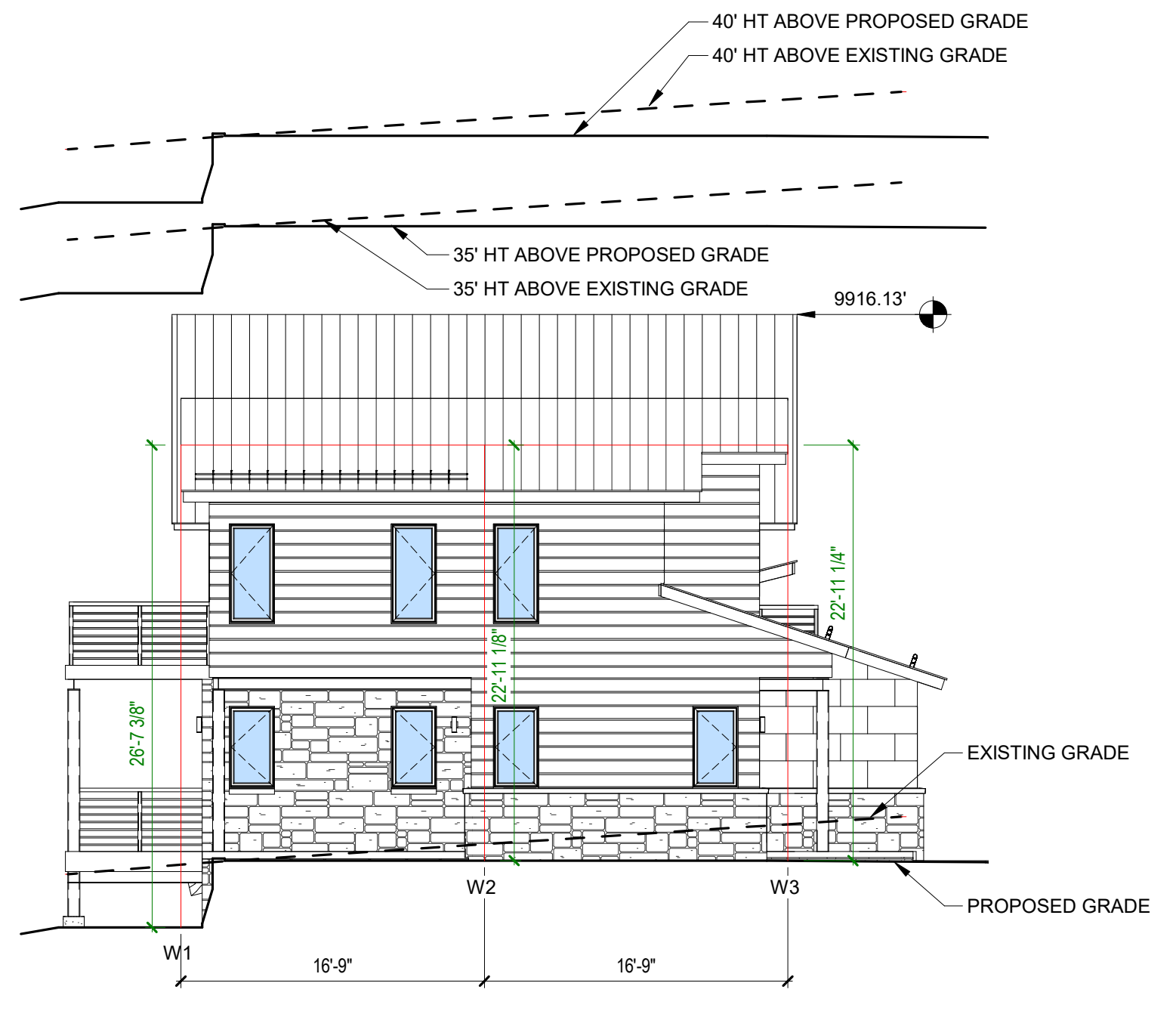

4 WEST ELEVATION
1/8" = 1'-0"

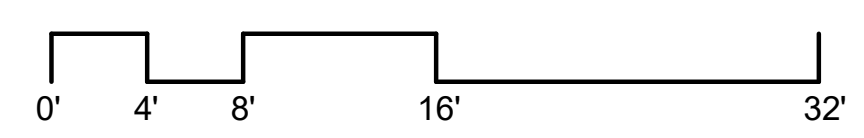

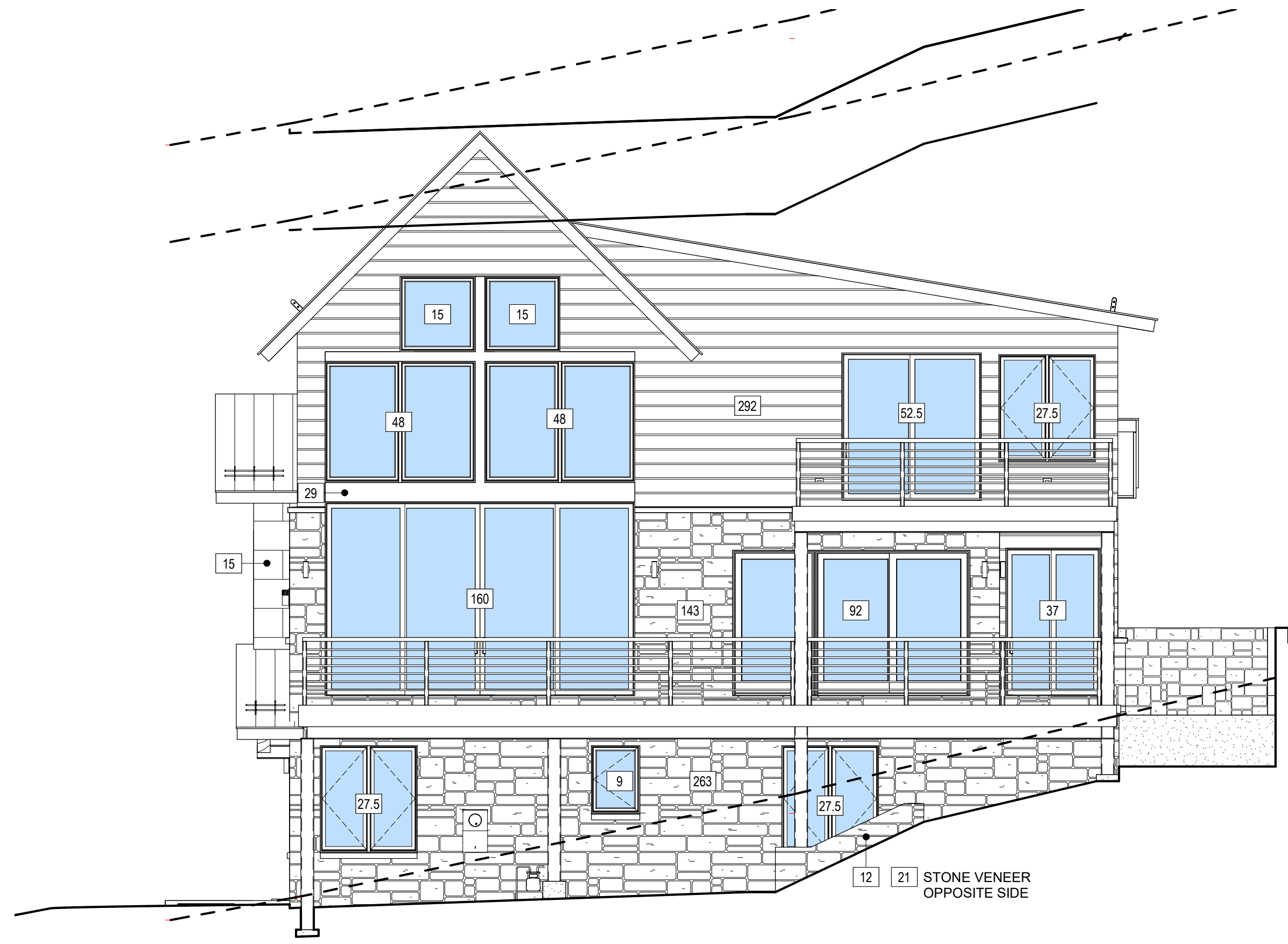

1 NORTH ELEVATION
3/16" = 1'-0"



2 EAST ELEVATION
3/16" = 1'-0"

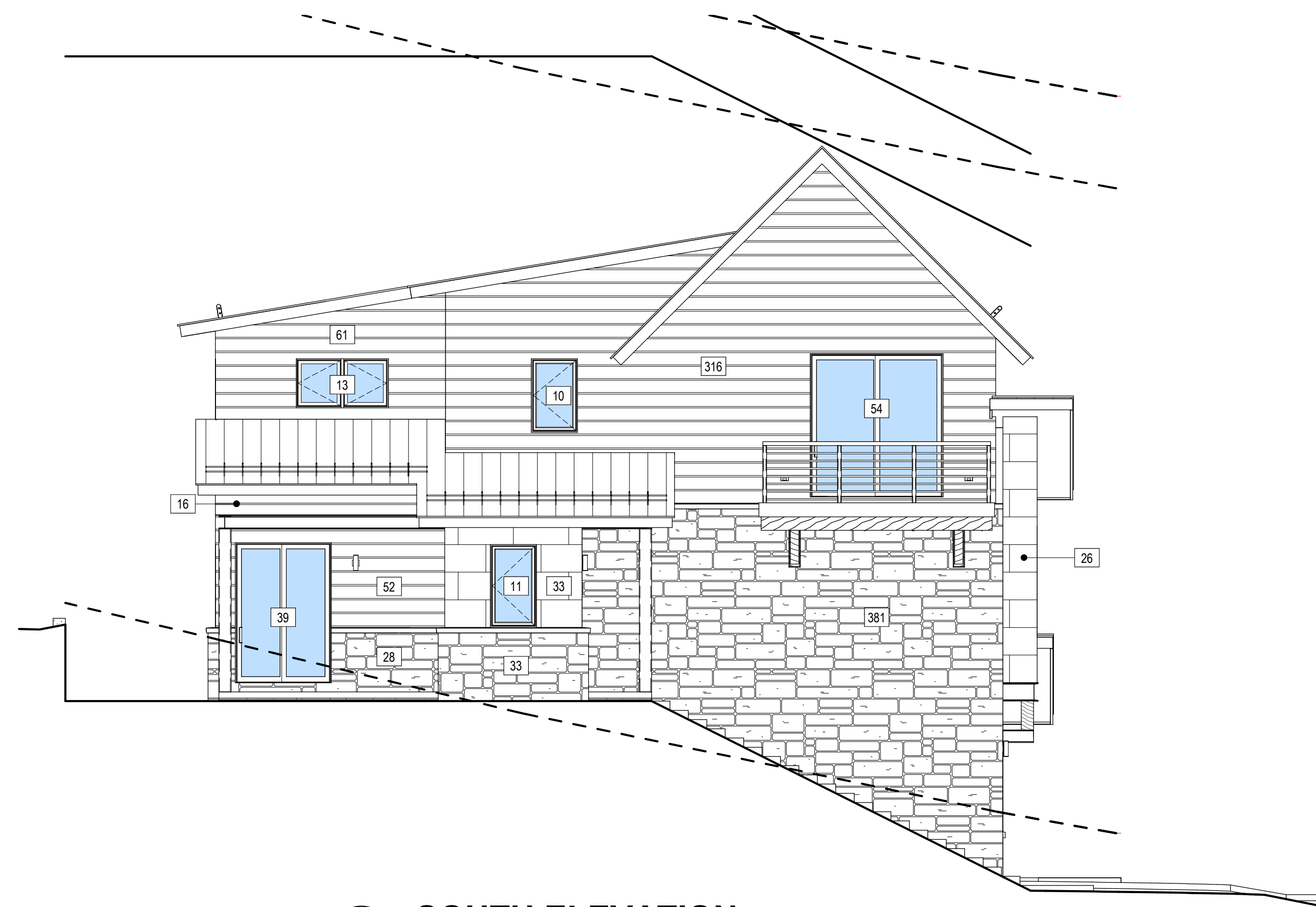

3 SOUTH ELEVATION
3/16" = 1'-0"

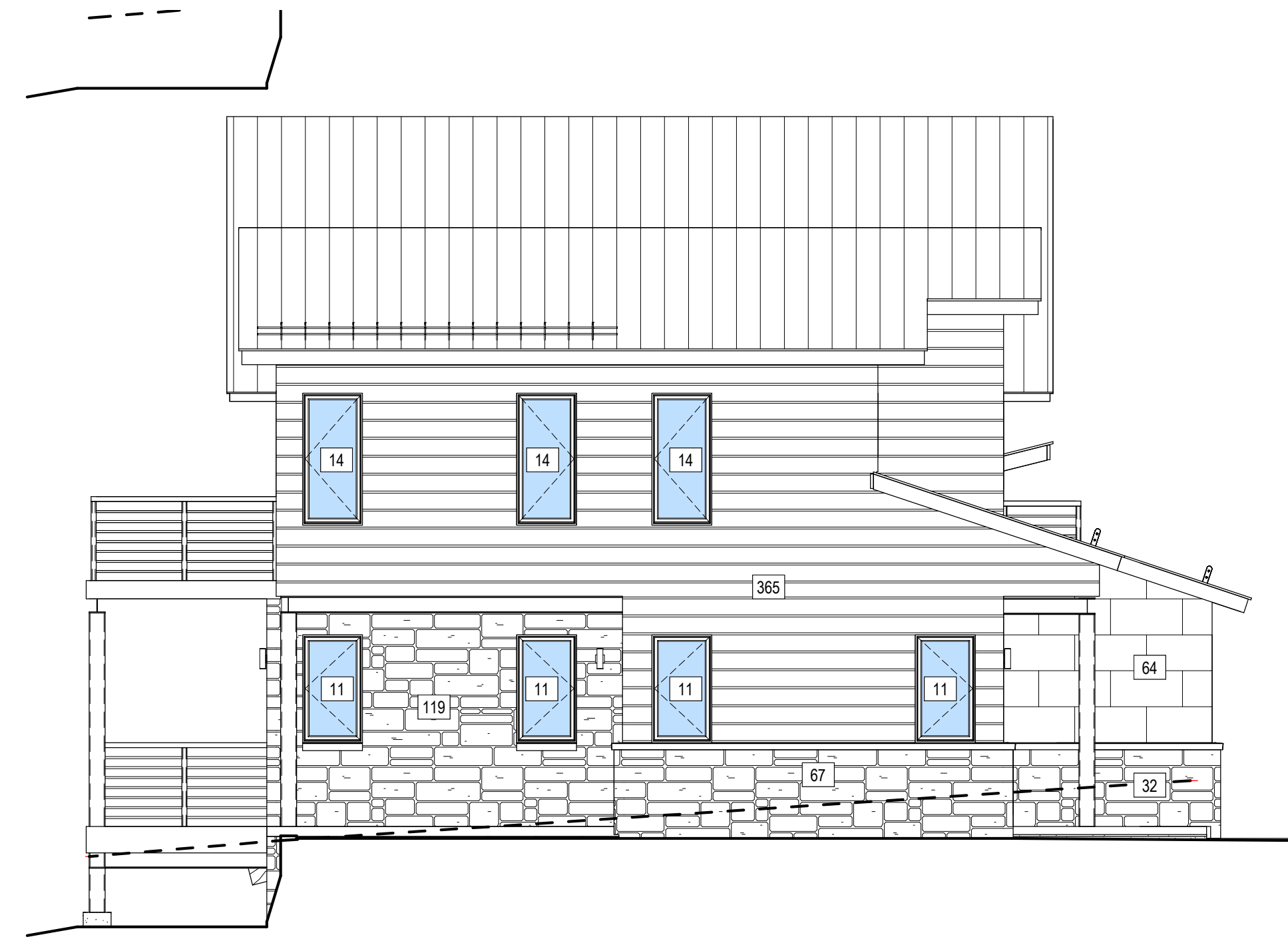

4 WEST ELEVATION
3/16" = 1'-0"

MATERIAL CALCULATIONS	
NORTH	
STONE	406 SF
STONE @ RETAINING WALL	33 SF
WOOD SIDING	292 SF
WINDOW/DOOR GLAZING	559 SF
METAL ACCENT	29 SF
METAL SIDING	15 SF
SOUTH	
STONE	442 SF
STONE @ RETAINING WALL	445 SF
WOOD SIDING	127 SF
METAL ACCENT	59 SF
EAST	
STONE	369 SF
STONE @ RETAINING WALL	34 SF
WOOD SIDING	186 SF
WINDOW/DOOR GLAZING	174 SF
METAL ACCENT	184 SF
GARAGE DOOR	72 SF
WEST	
STONE	218 SF
STONE @ RETAINING WALL	365 SF
WOOD SIDING	86 SF
METAL ACCENT	64 SF
TOTALS	
STONE	1,435 SF
STONE @ RETAINING WALL	67 SF
WOOD SIDING	1,288 SF
WINDOW/DOOR GLAZING	946 SF
METAL ACCENT	29 SF
METAL SIDING	322 SF
GARAGE DOOR	72 SF
TOTAL:	4,159 SF
PERCENTAGES	
STONE	35 %
STONE @ RETAINING WALL	2 %
WOOD SIDING	30 %
WINDOW/DOOR GLAZING	22 %
METAL ACCENT	1 %
METAL SIDING	8 %
GARAGE DOOR	2 %
TOTAL:	100 %
STONE VENEER CALCULATIONS ARE IN ACCORDANCE WITH TITLE 17 OF THE TOWN OF MOUNTAIN VILLAGE MUNICIPAL CODE CDC 17.5.6.E.1	

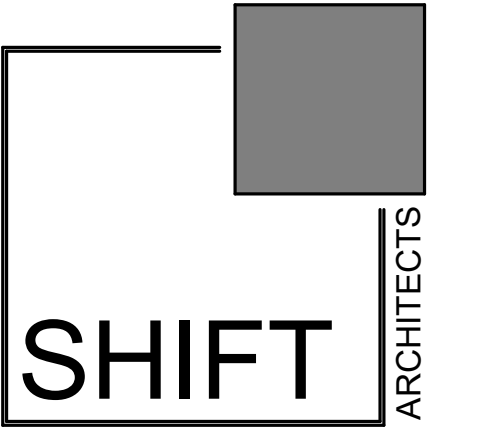

P.O. Box 3206
100 W. Colorado Suite 211
Telluride, Colorado 81435
p 970-728-8145
kristine@shift-architects.com
www.shift-architects.com

PROJECT ISSUE DATE:
02.01.21 DRB PRELIMINARY
SUBMITTAL

REVISIONS
NO. DATE DESC.

MOUNTAIN VIEW ESTATES UNIT 3
 162 SAN JOAQUIN RD. 3, MOUNTAIN VILLAGE, CO 81435
 UNIT 3 MOUNTAIN VIEW ESTATES, TOWN OF MOUNTAIN VILLAGE, SAN MIGUEL COUNTY, ACCORDING TO THE MAP RECORDED NOVEMBER 28, 2005 IN
 PLAY BOOK 1 AT PAGE 3573, AND AS DEFINED AND DESCRIBED IN THE DECLARATION OF COMMON INTEREST COMMUNITY FOR MOUNTAIN VIEW
 ESTATES, RECORDED NOVEMBER 28, 2005 UNDER RECEPTION NO. 379791 AND AS AMENDED BY INSTRUMENT RECORDED DECEMBER 5, 2018 UNDER
 RECEPTION NO. 456632, COUNTY OF SAN MIGUEL, STATE OF COLORADO.

MATERIAL
CALCULATIONS

SHEET NUMBER

A2.2

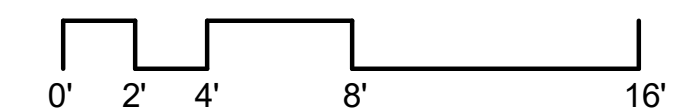

2/3/2021 9:23:16 AM

NOT FOR CONSTRUCTION

@shift architects

FLOOR PLAN GENERAL NOTES:

DIMENSIONS:
ALL PLAN DIMENSIONS ARE TO STRUCTURE (STUD, CONCRETE, ETC). ANY DISCREPANCIES ARE TO BE BROUGHT TO THE ATTENTION OF THE ARCHITECT.

DOORS ARE TO BE LOCATED IN THE CENTER OF THE WALL OR PROVIDE 5" WALL RETURNS U.N.O.

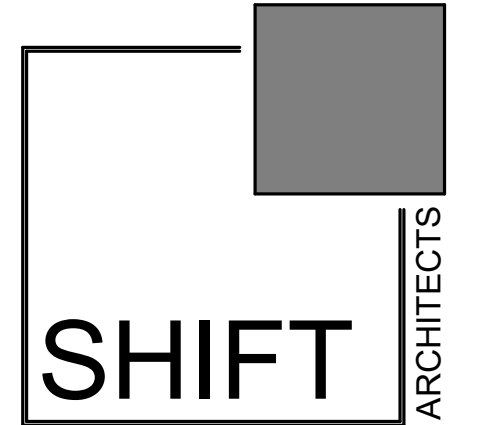

P.O. Box 3206
100 W. Colorado Suite 211
Telluride, Colorado 81435
p 970-728-8145
kristine@shift-architects.com
www.shift-architects.com

PROJECT ISSUE DATE:
02.01.21 DRB PRELIMINARY
SUBMITTAL

REVISIONS
NO. DATE DESC.

MOUNTAIN VIEW ESTATES UNIT 3
162 SAN JOAQUIN RD. 3, MOUNTAIN VILLAGE, CO 81435
UNIT 3 MOUNTAIN VIEW ESTATES, TOWN OF MOUNTAIN VILLAGE, SAN MIGUEL COUNTY, ACCORDING TO THE MAP RECORDED NOVEMBER 28, 2005 IN
PLAT BOOK 1 AT PAGE 3573, AND AS DEFINED AND DESCRIBED IN THE DECLARATION OF COMMON INTEREST COMMUNITY FOR MOUNTAIN VIEW
ESTATES, RECORDED NOVEMBER 28, 2005 UNDER RECEPTION NO. 379791 AND AS AMENDED BY INSTRUMENT RECORDED DECEMBER 5, 2018 UNDER
RECEPTION NO. 456632, COUNTY OF SAN MIGUEL, STATE OF COLORADO.

FLOOR PLANS

SHEET NUMBER

A3.1

NOT FOR CONSTRUCTION

©shift architects

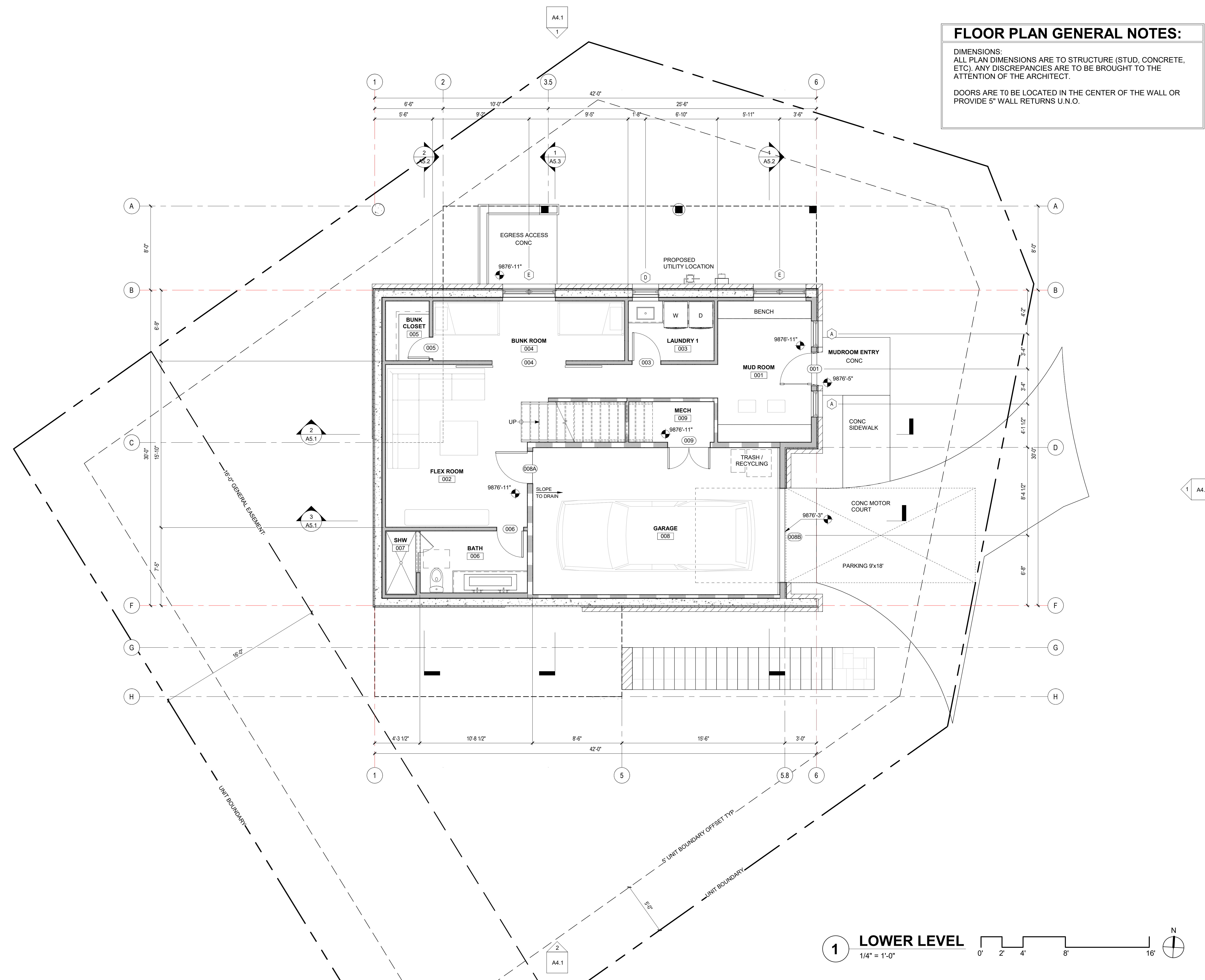

1 LOWER LEVEL
1/4" = 1'-0"

2/3/2021 9:23:17 AM

FLOOR PLAN GENERAL NOTES:

DIMENSIONS:
ALL PLAN DIMENSIONS ARE TO STRUCTURE (STUD, CONCRETE, ETC). ANY DISCREPANCIES ARE TO BE BROUGHT TO THE ATTENTION OF THE ARCHITECT.

DOORS ARE TO BE LOCATED IN THE CENTER OF THE WALL OR PROVIDE 5" WALL RETURNS U.N.O.

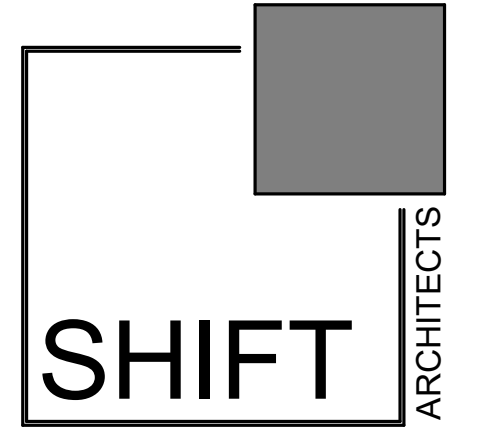

P.O. Box 3206
100 W. Colorado Suite 211
Telluride, Colorado 81435
p 970-728-8145
kristine@shift-architects.com
www.shift-architects.com

PROJECT ISSUE DATE:
02.01.21 DRB PRELIMINARY
SUBMITTAL

REVISIONS
NO. DATE DESC.

MOUNTAIN VIEW ESTATES UNIT 3
162 SAN JOAQUIN RD. 3, MOUNTAIN VILLAGE, CO 81435
UNIT 3 MOUNTAIN VIEW ESTATES, TOWN OF MOUNTAIN VILLAGE, SAN MIGUEL COUNTY, ACCORDING TO THE MAP RECORDED NOVEMBER 28, 2005 IN
PLAY BOOK 1 AT PAGE 3573, AND AS DEFINED AND DESCRIBED IN THE DECLARATION OF COMMON INTEREST COMMUNITY FOR MOUNTAIN VIEW
ESTATES, RECORDED NOVEMBER 28, 2005 UNDER RECEPTION NO. 379791 AND AS AMENDED BY INSTRUMENT RECORDED DECEMBER 5, 2018 UNDER
RECEPTION NO. 456632, COUNTY OF SAN MIGUEL, STATE OF COLORADO.

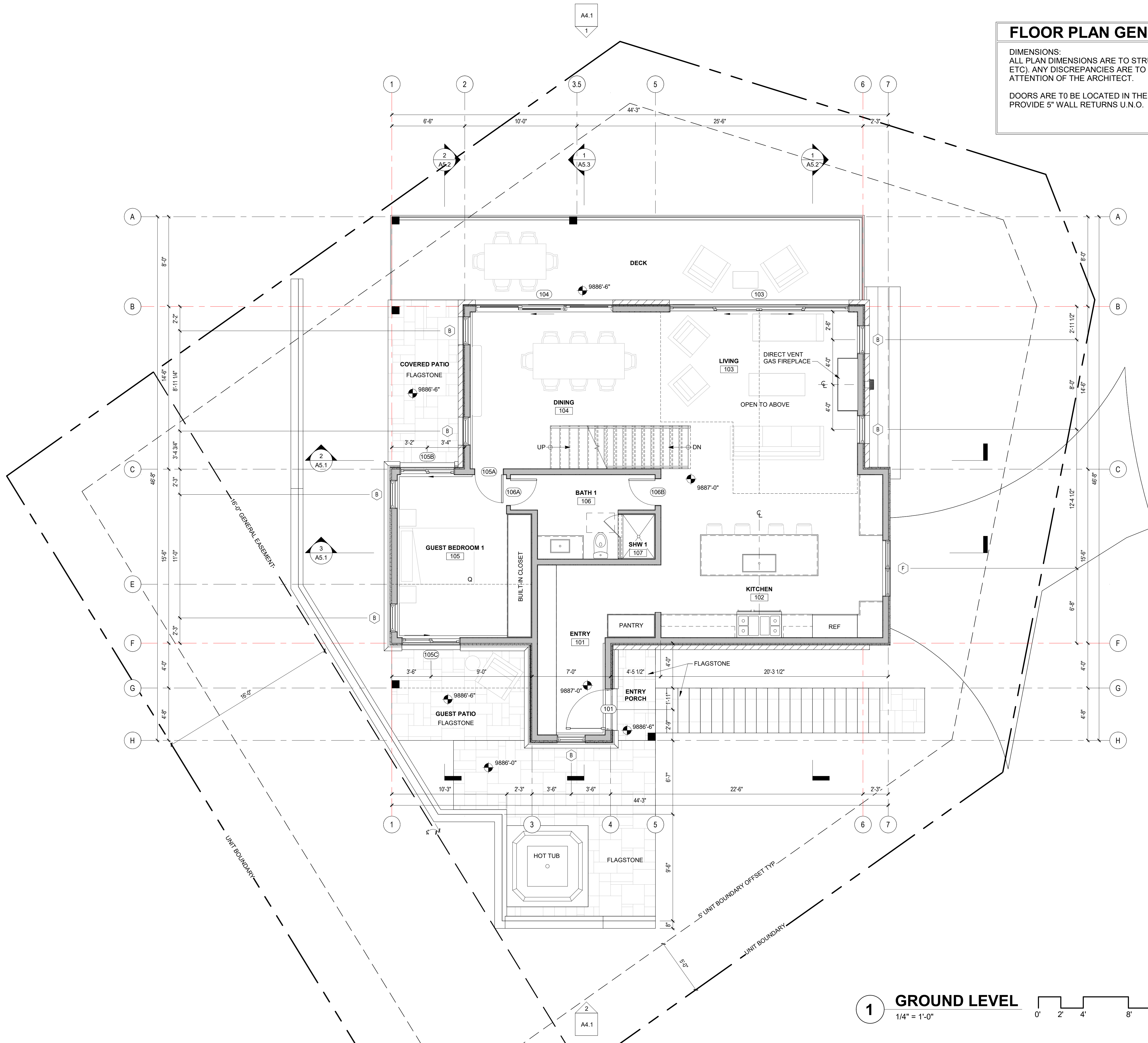

1 GROUND LEVEL
1/4" = 1'-0"

FLOOR PLANS

SHEET NUMBER

A3.2

2/3/2021 9:23:17 AM

NOT FOR CONSTRUCTION

©shift architects

FLOOR PLAN GENERAL NOTES:

DIMENSIONS:
ALL PLAN DIMENSIONS ARE TO STRUCTURE (STUD, CONCRETE, ETC). ANY DISCREPANCIES ARE TO BE BROUGHT TO THE ATTENTION OF THE ARCHITECT.

DOORS ARE TO BE LOCATED IN THE CENTER OF THE WALL OR PROVIDE 5" WALL RETURNS U.N.O.

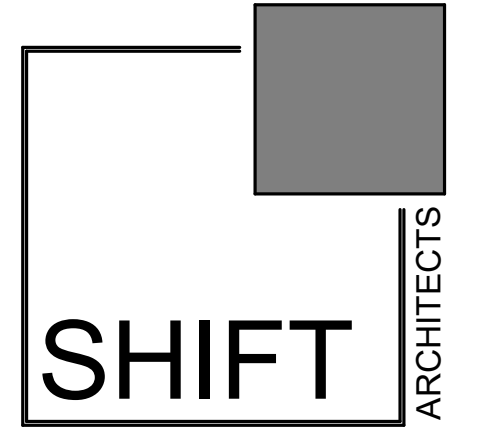

P.O. Box 3206
100 W. Colorado Suite 211
Telluride, Colorado 81435
p 970-728-8145
kristine@shift-architects.com
www.shift-architects.com

PROJECT ISSUE DATE:
02.01.21 DRB PRELIMINARY
SUBMITTAL

REVISIONS
NO. DATE DESC.

MOUNTAIN VIEW ESTATES UNIT 3
162 SAN JOAQUIN RD. 3, MOUNTAIN VILLAGE, CO 81435
UNIT 3 MOUNTAIN VIEW ESTATES, TOWN OF MOUNTAIN VILLAGE, SAN MIGUEL COUNTY, ACCORDING TO THE MAP RECORDED NOVEMBER 28, 2005 IN PLAT BOOK 1 AT PAGE 3573, AND AS DEFINED AND DESCRIBED IN THE DECLARATION OF COMMON INTEREST COMMUNITY FOR MOUNTAIN VIEW ESTATES, RECORDED NOVEMBER 28, 2005 UNDER RECEPTION NO. 379791 AND AS AMENDED BY INSTRUMENT RECORDED DECEMBER 5, 2018 UNDER RECEPTION NO. 456632, COUNTY OF SAN MIGUEL, STATE OF COLORADO.

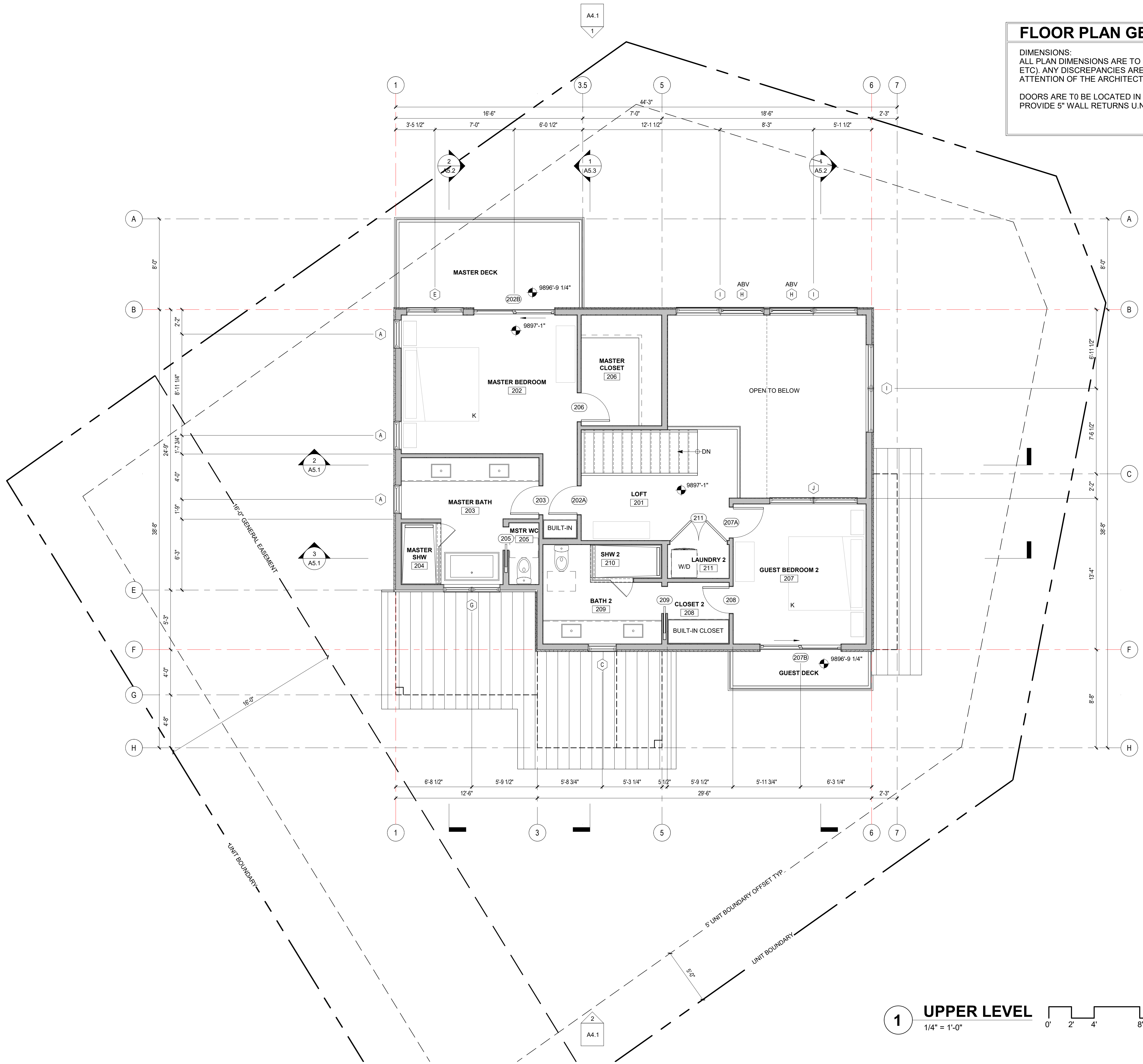

1 UPPER LEVEL
1/4" = 1'-0"

FLOOR PLANS

SHEET NUMBER

A3.3

2/3/2021 9:23:18 AM

NOT FOR CONSTRUCTION

©shift architects

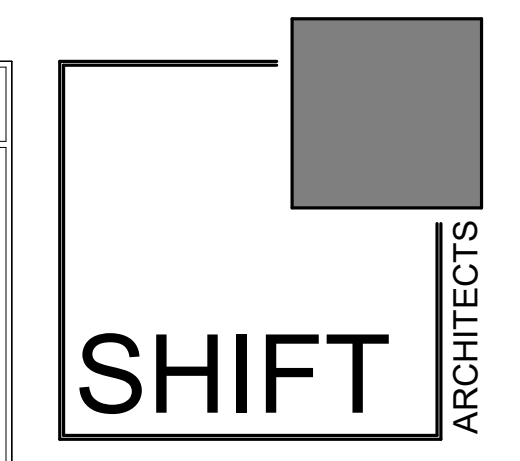

P.O. Box 3206
 100 W. Colorado Suite 211
 Telluride, Colorado 81435
 p 970-728-8145
 kristine@shift-architects.com
 www.shift-architects.com

PROJECT ISSUE DATE:
 02.01.21 DRB PRELIMINARY
 SUBMITTAL

REVISIONS
 NO. DATE DESC.

MOUNTAIN VIEW ESTATES UNIT 3
 162 SAN JOAQUIN RD. 3, MOUNTAIN VILLAGE, CO 81435
 UNIT 3 MOUNTAIN VIEW ESTATES, TOWN OF MOUNTAIN VILLAGE, SAN MIGUEL COUNTY, ACCORDING TO THE MAP RECORDED NOVEMBER 28, 2005 IN
 PLAT BOOK 1 AT PAGE 3573, AND AS DEFINED AND DESCRIBED IN THE DECLARATION OF COMMON INTEREST COMMUNITY FOR MOUNTAIN VIEW
 ESTATES, RECORDED NOVEMBER 28, 2005 UNDER RECEPTION NO. 379791 AND AS AMENDED BY INSTRUMENT RECORDED DECEMBER 5, 2018 UNDER
 RECEPTION NO. 456632, COUNTY OF SAN MIGUEL, STATE OF COLORADO.

ROOF PLAN

SHEET NUMBER

A3.4

NOT FOR CONSTRUCTION

©shift architects

- ROOF PLAN NOTES**
1. ROOFING SYSTEM TO BE INSTALLED IN ACCORDANCE WITH MANUFACTURER'S INSTRUCTIONS.
 2. ALL OVERHANG DIMENSIONS ARE FROM EXTERIOR FACE OF STUD (GRID) TO STRUCTURAL ROOF.
 3. PROVIDE SNOW RETENTION SYSTEM WHERE SHOWN. CONTRACTOR AND ROOF MANUFACTURER TO PROVIDE WATERPROOFING FOR FULL WARRANTY AT SNOW RETENTION PENETRATIONS TYP.
 4. REFERENCE MECHANICAL DRAWINGS FOR LOCATIONS OF ROOF PENETRATIONS.
 5. PAINT ALL ROOF APPURTENANCES TO MATCH ADJACENT ROOF.

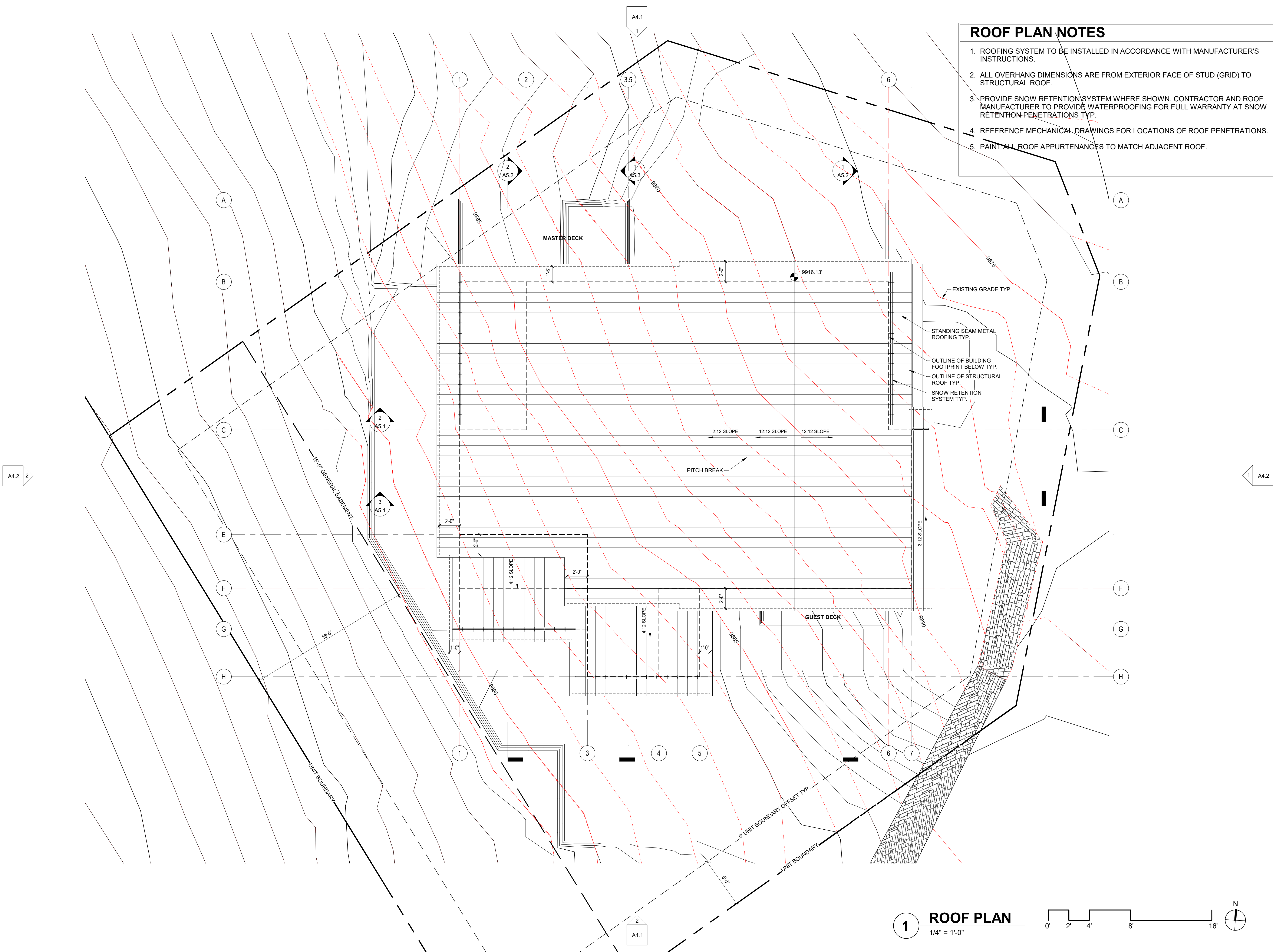

1 ROOF PLAN
 1/4" = 1'-0"

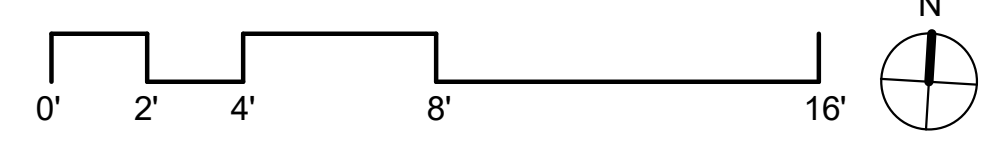

2/3/2021 9:23:19 AM

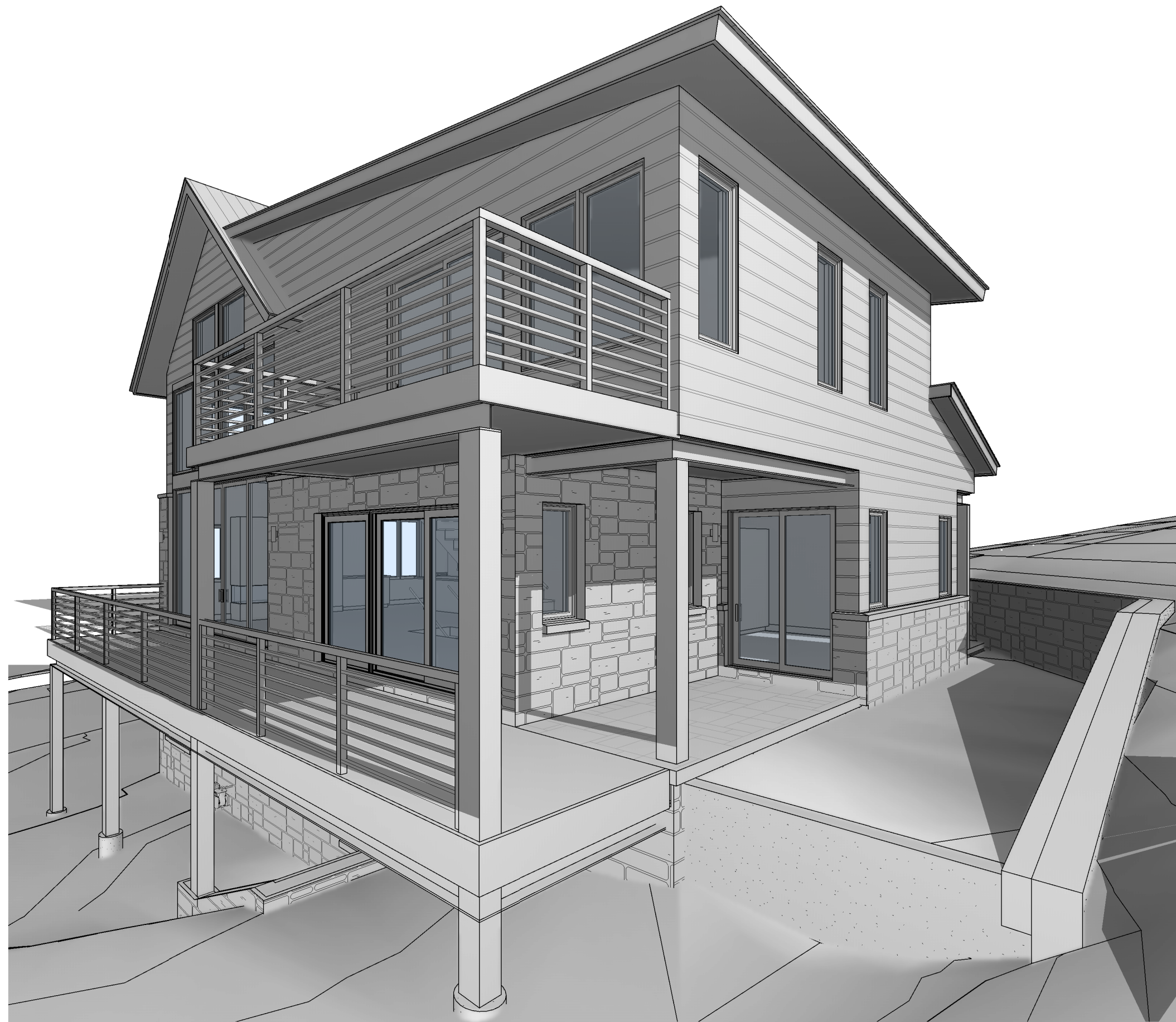

1 NORTHWEST

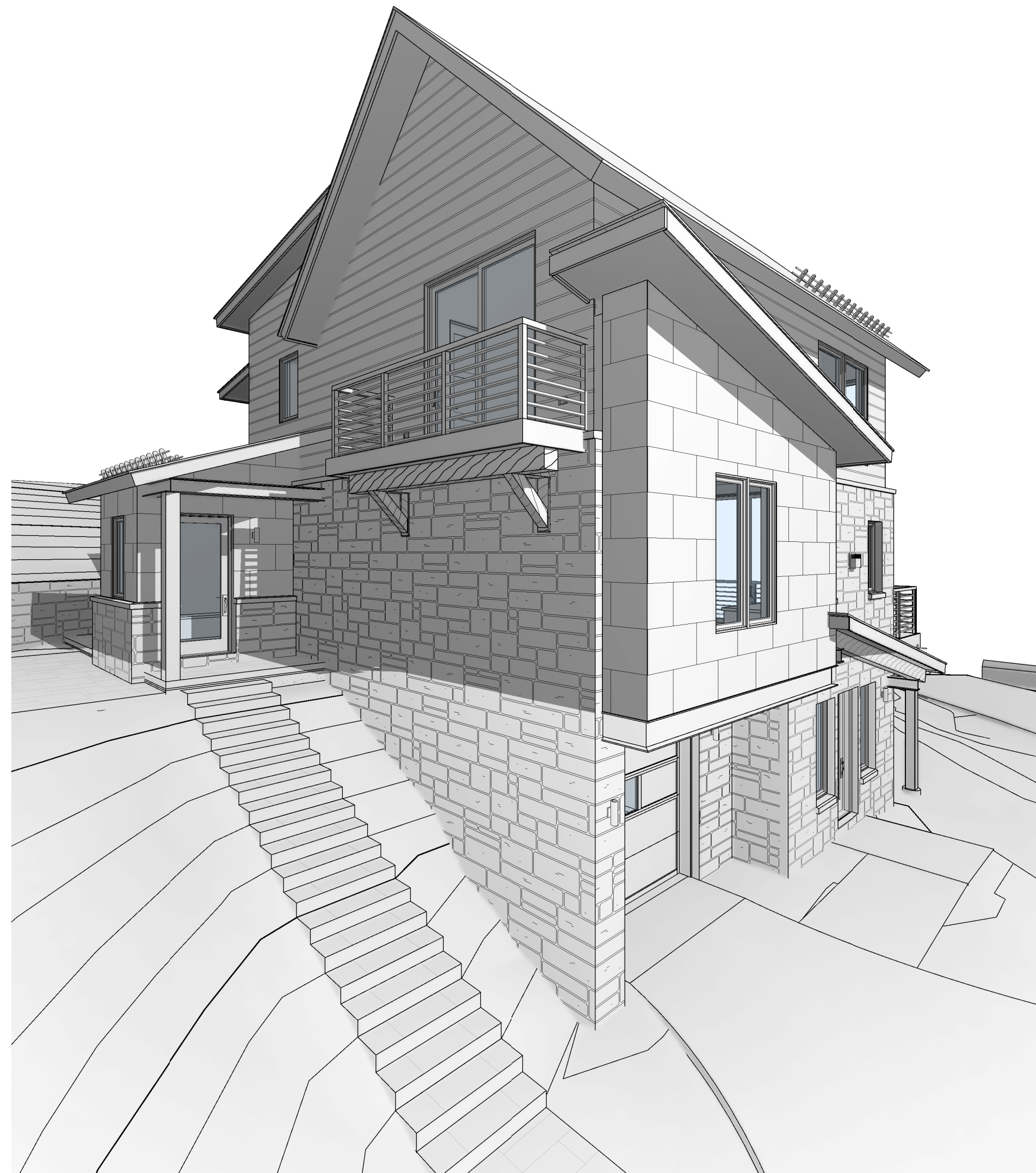

3 SOUTHEAST

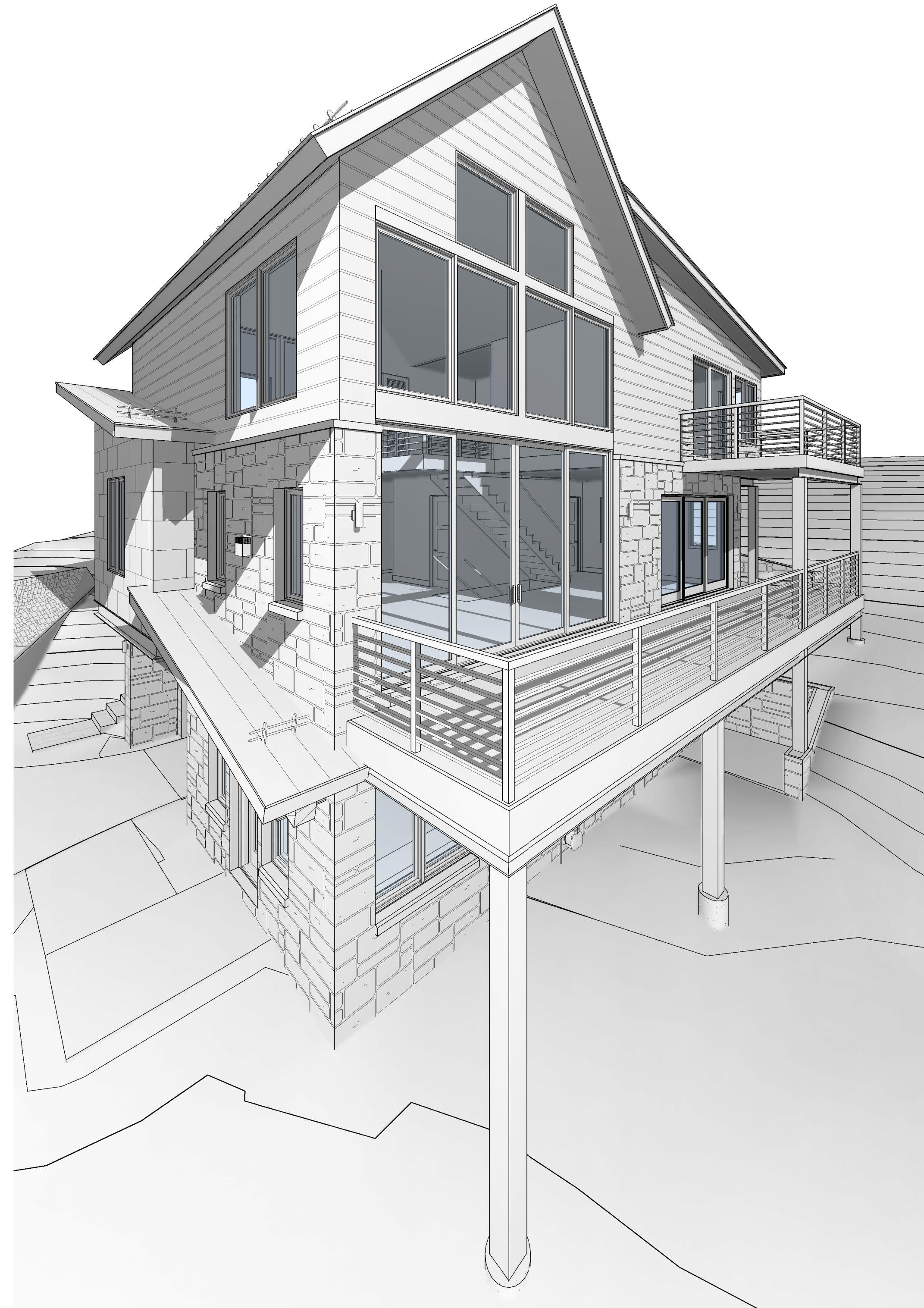

2 NORTHEAST

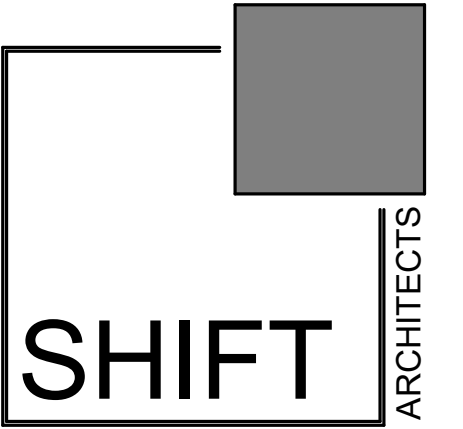

P.O. Box 3206
 100 W. Colorado Suite 211
 Telluride, Colorado 81435
 p 970-728-8145
 kristine@shift-architects.com
 www.shift-architects.com

PROJECT ISSUE DATE:
 02.01.21 DRB PRELIMINARY
 SUBMITTAL

REVISIONS
 NO. DATE DESC.

MOUNTAIN VIEW ESTATES UNIT 3
 162 SAN JOAQUIN RD. 3, MOUNTAIN VILLAGE, CO 81435
 UNIT 3 MOUNTAIN VIEW ESTATES, TOWN OF MOUNTAIN VILLAGE, SAN MIGUEL COUNTY, ACCORDING TO THE MAP RECORDED NOVEMBER 28, 2005 IN
 PLAT BOOK 1 AT PAGE 3573, AND AS DEFINED AND DESCRIBED IN THE DECLARATION OF COMMON INTEREST COMMUNITY FOR MOUNTAIN VIEW
 ESTATES, RECORDED NOVEMBER 28, 2005 UNDER RECEPTION NO. 379791 AND AS AMENDED BY INSTRUMENT RECORDED DECEMBER 5, 2018 UNDER
 RECEPTION NO. 456632, COUNTY OF SAN MIGUEL, STATE OF COLORADO.

AXONS

SHEET NUMBER

A4.0

2/3/2021 9:23:26 AM

©shift architects
 NOT FOR CONSTRUCTION

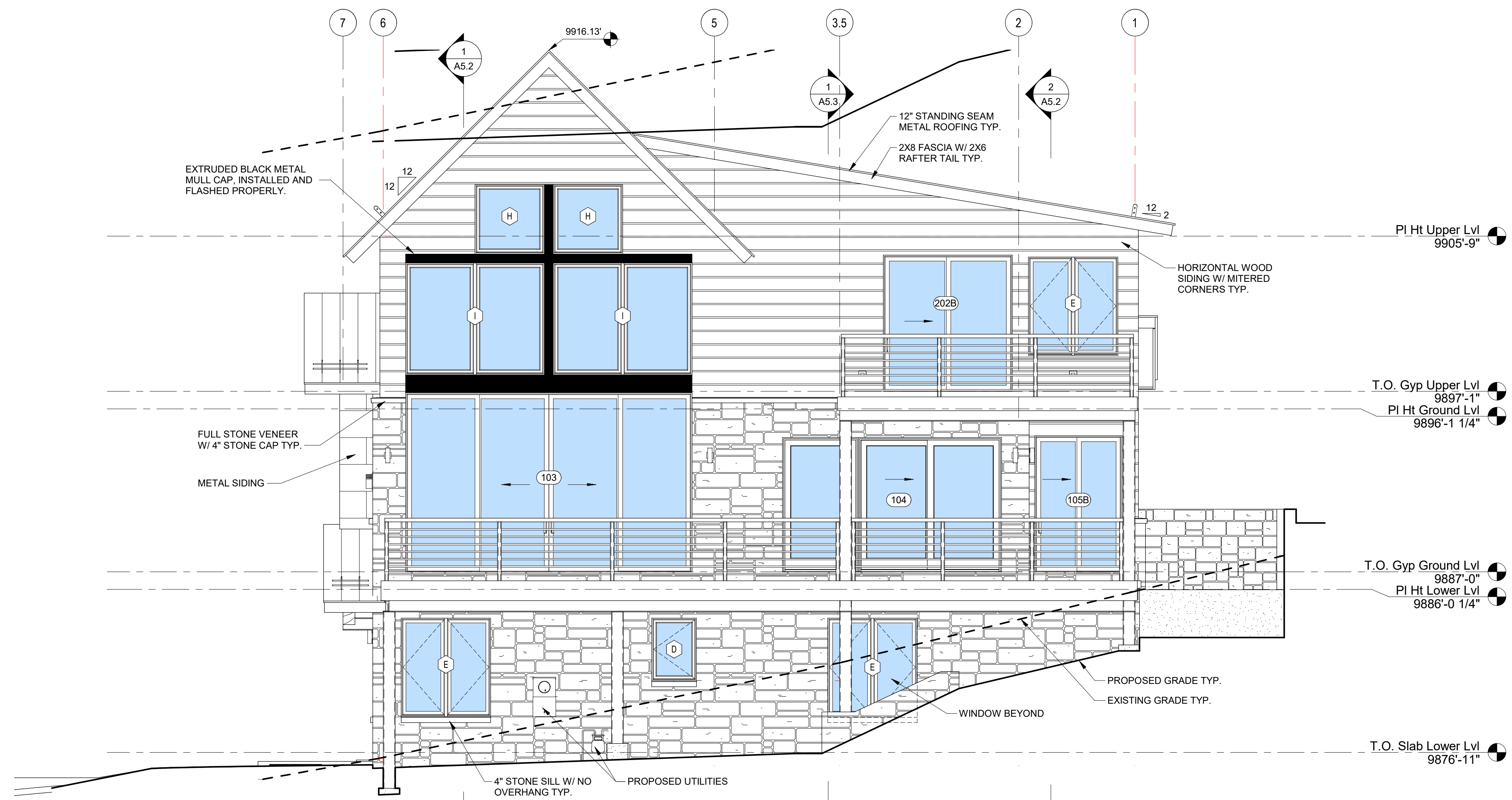

1 NORTH ELEVATION
1/4" = 1'-0"

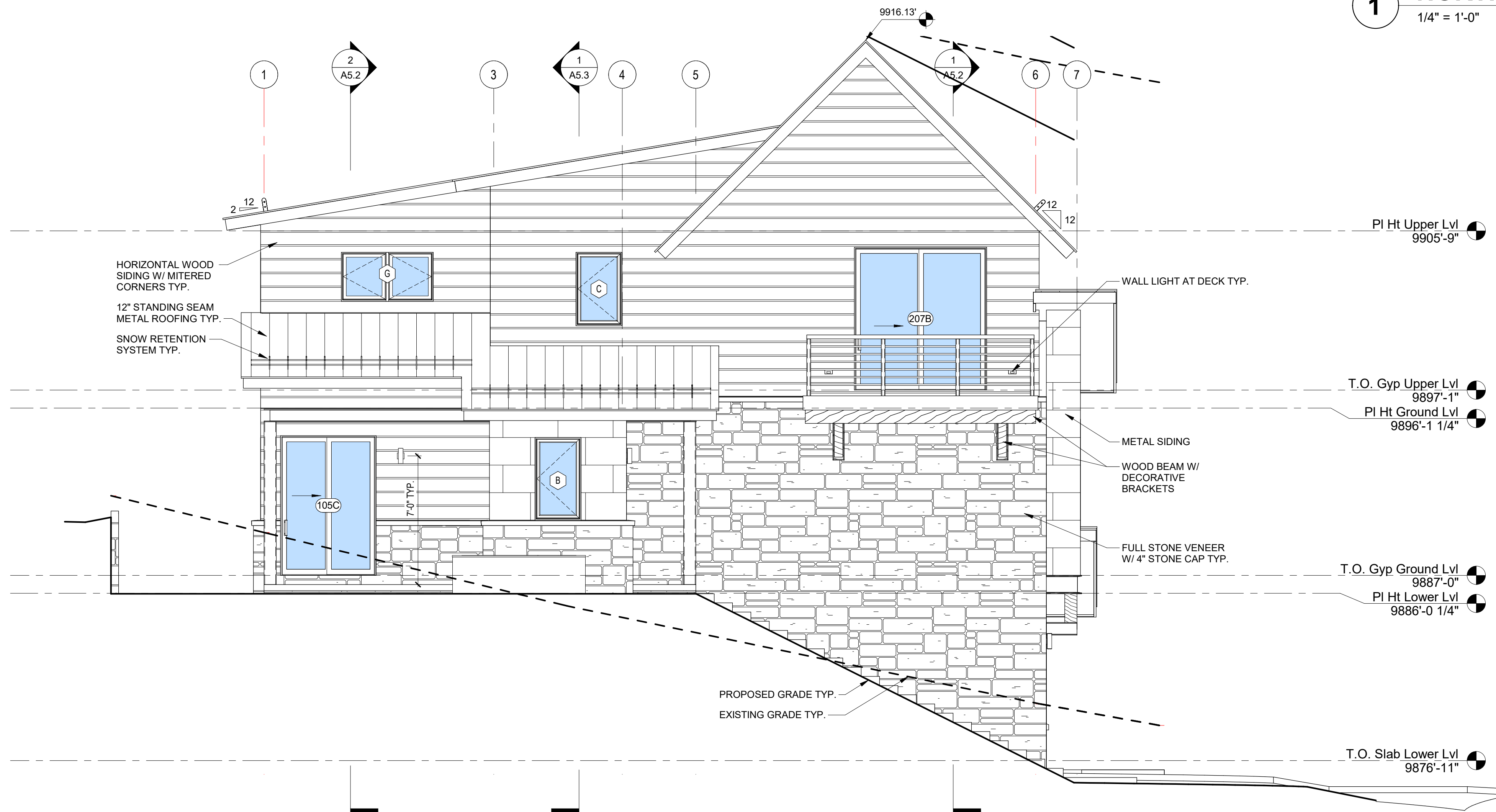

2 SOUTH ELEVATION
1/4" = 1'-0"



TELLURIDE STONE
GOLD COLLECTION
SKYLINE
FULL STONE VENEER

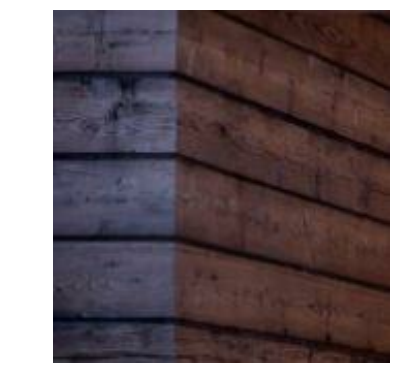

HORIZ WOOD SIDING:
8" DOUG FIR HORIZ SIDING W/ 1" METAL
RECESS. MITERED CORNERS

FINISH: TYPICAL STAIN, METAL PAINTED BLACK



TYPICAL STAIN:
CABOT CORDOVAN BROWN (SEMI-
TRANSPARENT)

STEEL BEAMS / COLUMNS:
FINISH: PAINTED BLACK

WOOD BEAMS:
FINISH: TYPICAL STAIN

FASCIA:
2X8 DOUG FIR FASCIA W/ 2X6 RAFTER TAIL
FINISH: TYPICAL STAIN

SOFFIT:
1X4 PINE
FINISH: TYPICAL STAIN



METAL SIDING:
18"X36" METAL PANEL
FINISH: RAW STEEL



ROOFING:
PAC-CLAD 150 12" STANDING SEAM
METAL ROOFING; MATTE BLACK



WINDOWS / DOORS:
LOEWEN ALUMN CLAD WOOD; BLACK

EXTERIOR MATERIALS

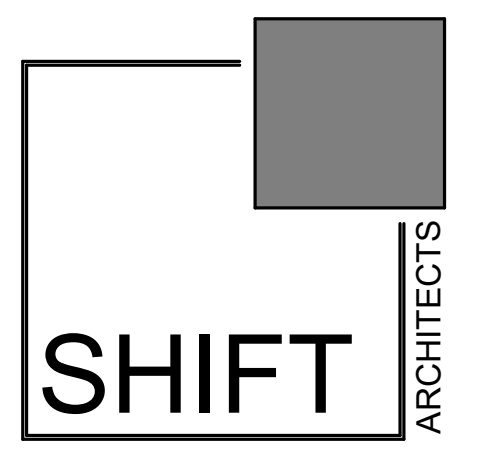

P.O. Box 3206
100 W. Colorado Suite 211
Telluride, Colorado 81435
p 970-728-8145
kristine@shift-architects.com
www.shift-architects.com

PROJECT ISSUE DATE:
02.01.21 DRB PRELIMINARY
SUBMITTAL

REVISIONS
NO. DATE DESC.

MOUNTAIN VIEW ESTATES UNIT 3
 162 SAN JOAQUIN RD. 3, MOUNTAIN VILLAGE, CO 81435
 UNIT 3 MOUNTAIN VIEW ESTATES, TOWN OF MOUNTAIN VILLAGE, SAN MIGUEL COUNTY, ACCORDING TO THE MAP RECORDED NOVEMBER 28, 2005 IN
 PLAY BOOK 1 AT PAGE 3573, AND AS DEFINED AND DESCRIBED IN THE DECLARATION OF COMMON INTEREST COMMUNITY FOR MOUNTAIN VIEW
 ESTATES, RECORDED NOVEMBER 28, 2005 UNDER RECEPTION NO. 379791 AND AS AMENDED BY INSTRUMENT RECORDED DECEMBER 5, 2018 UNDER
 RECEPTION NO. 456632, COUNTY OF SAN MIGUEL, STATE OF COLORADO.

EXTERIOR
ELEVATIONS

SHEET NUMBER

A4.1

NOT FOR CONSTRUCTION

©shift architects

2/3/2021 9:23:27 AM

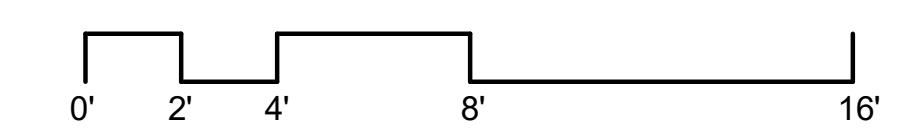

RAILING SYSTEM TO BE PAINTED BLACK

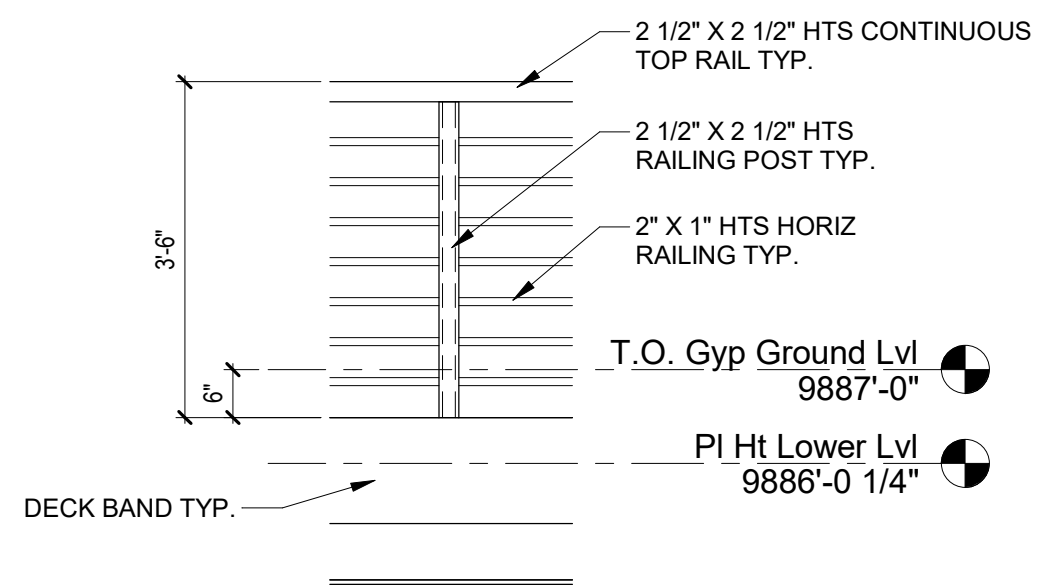

3 EXTERIOR METAL RAILING
1/2" = 1'-0"

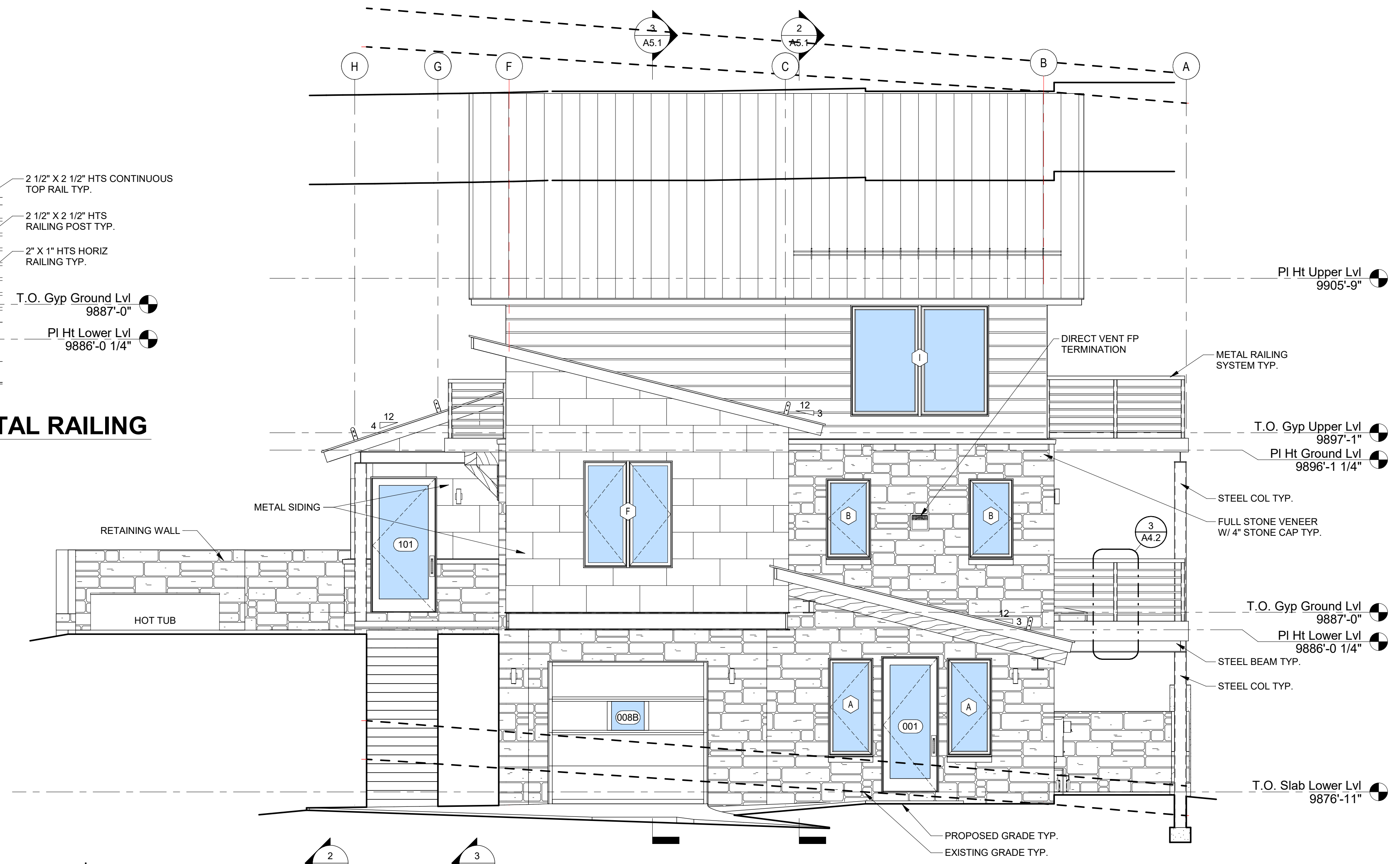

1 EAST ELEVATION
1/4" = 1'-0"

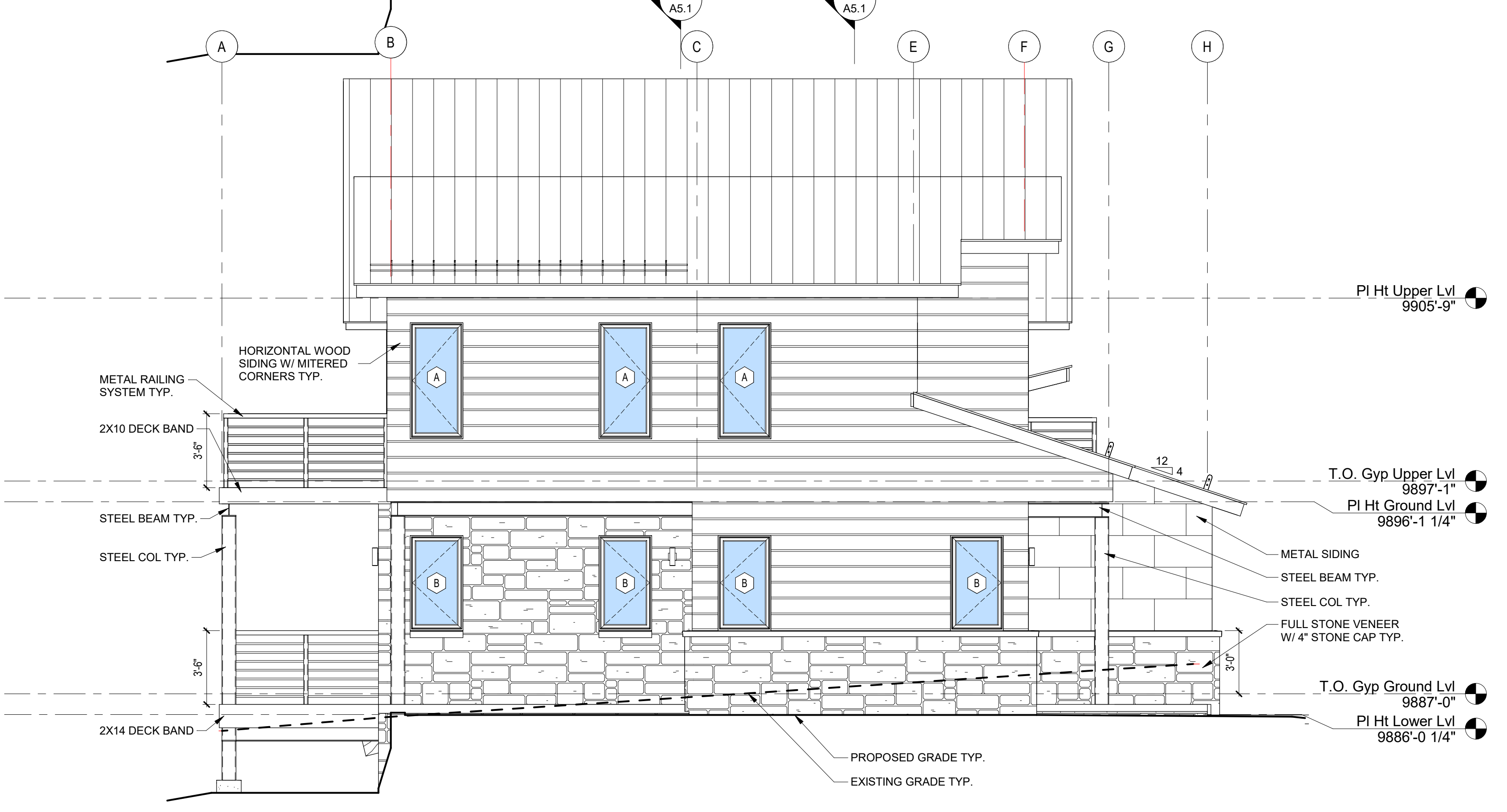

2 WEST ELEVATION
1/4" = 1'-0"



TELLURIDE STONE GOLD COLLECTION SKYLINE FULL STONE VENEER



HORIZ WOOD SIDING: 8" DOUG FIR HORIZ SIDING W/ 1" METAL RECESS. MITERED CORNERS

FINISH: TYPICAL STAIN, METAL PAINTED BLACK



TYPICAL STAIN: CABOT CORDOVAN BROWN (SEMI-TRANSPARENT)

STEEL BEAMS / COLUMNS: FINISH: PAINTED BLACK

WOOD BEAMS: FINISH: TYPICAL STAIN

FASCIA: 2X8 DOUG FIR FASCIA W/ 2X6 RAFTER TAIL FINISH: TYPICAL STAIN

SOFFIT: 1X4 PINE FINISH: TYPICAL STAIN



METAL SIDING: 18"X36" METAL PANEL FINISH: RAW STEEL

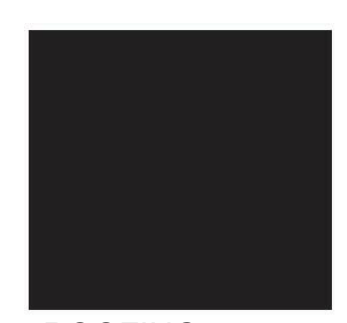

ROOFING: PAC-CLAD 150 12" STANDING SEAM METAL ROOFING; MATTE BLACK

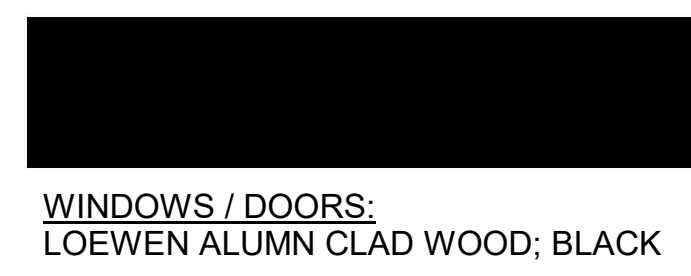

WINDOWS / DOORS: LOEWEN ALUMN CLAD WOOD; BLACK

EXTERIOR MATERIALS

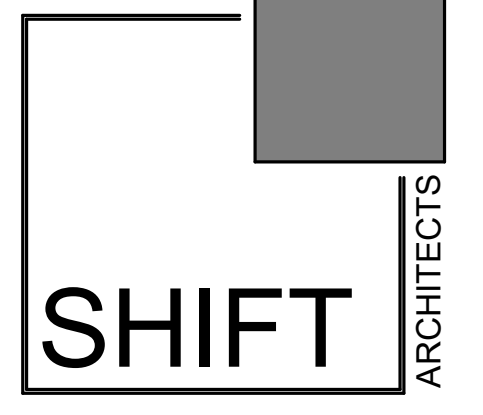
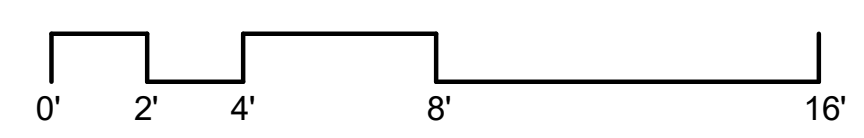

P.O. Box 3206
100 W. Colorado Suite 211
Telluride, Colorado 81435
p 970-728-8145
kristine@shift-architects.com
www.shift-architects.com

PROJECT ISSUE DATE:
02.01.21 DRB PRELIMINARY SUBMITTAL

REVISIONS
NO. DATE DESC.

MOUNTAIN VIEW ESTATES UNIT 3
 162 SAN JOAQUIN RD. 3, MOUNTAIN VILLAGE, CO 81435
 UNIT 3 MOUNTAIN VIEW ESTATES, TOWN OF MOUNTAIN VILLAGE, SAN MIGUEL COUNTY, ACCORDING TO THE MAP RECORDED NOVEMBER 28, 2005 IN PLAT BOOK 1 AT PAGE 3573, AND AS DEFINED AND DESCRIBED IN THE DECLARATION OF COMMON INTEREST COMMUNITY FOR MOUNTAIN VIEW ESTATES, RECORDED NOVEMBER 28, 2005 UNDER RECEPTION NO. 379791 AND AS AMENDED BY INSTRUMENT RECORDED DECEMBER 5, 2018 UNDER RECEPTION NO. 456632, COUNTY OF SAN MIGUEL, STATE OF COLORADO.

EXTERIOR ELEVATIONS

SHEET NUMBER

A4.2

NOT FOR CONSTRUCTION

©shift architects

2/3/2021 9:23:28 AM



1 NORTH ELEVATION
 3/16" = 1'-0"



2 EAST ELEVATION
 3/16" = 1'-0"



3 SOUTH ELEVATION
 3/16" = 1'-0"



4 WEST ELEVATION
 3/16" = 1'-0"

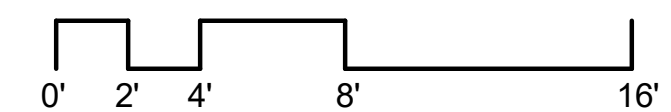

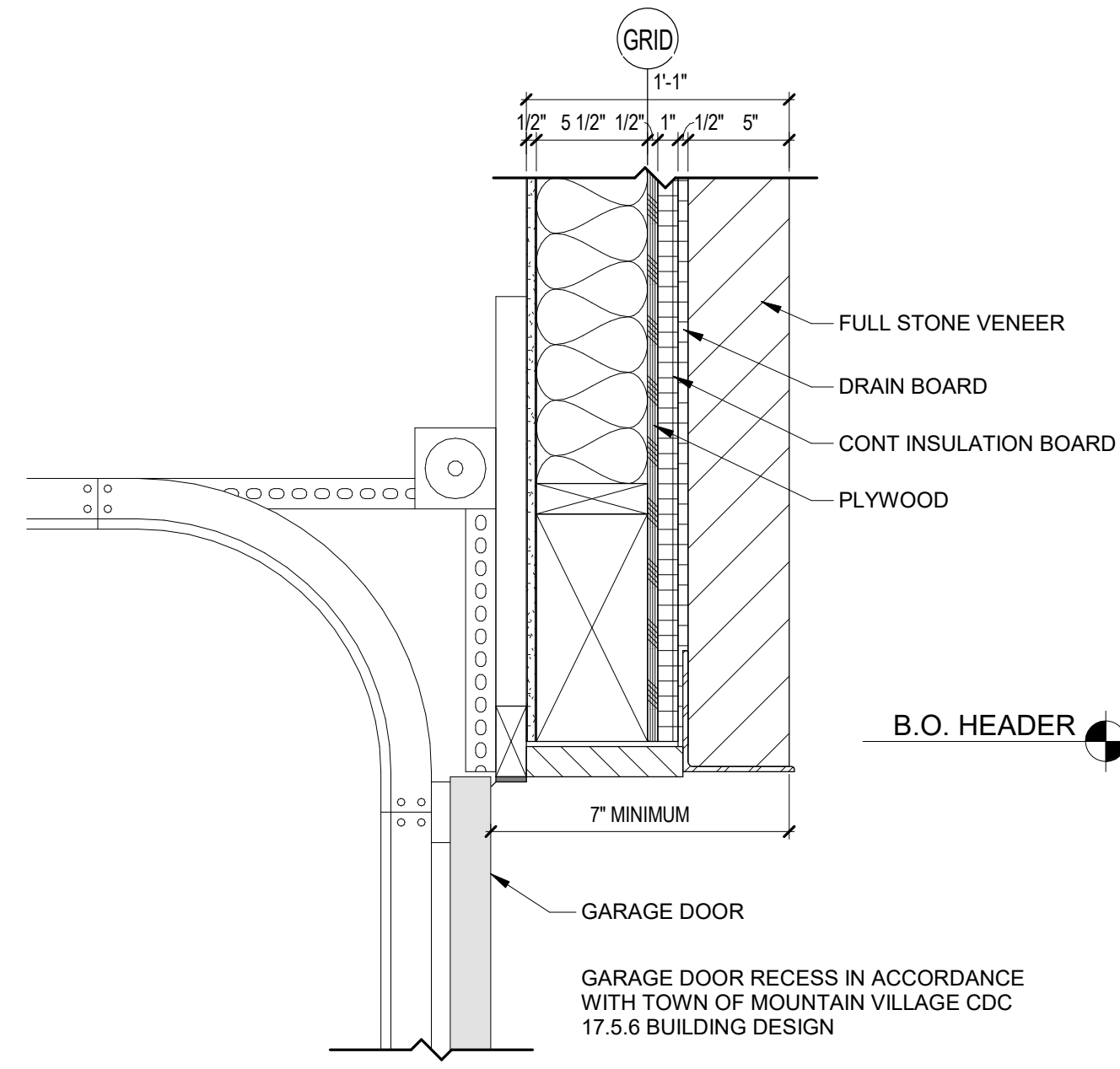

1 GARAGE DOOR RECESS
1 1/2" = 1'-0"

DOOR SCHEDULE									
MARK	ROOM NAME	TYPE MARK	WIDTH	HEIGHT	TYPE	MANUFACTURER	LOCATION	COMMENTS	
001	MUD ROOM	A	3'-0"	7'-6"	SWING	LOEWEN ALUMN CLAD WOOD; BLACK	EXTERIOR		
008B	GARAGE	E	9'-0"	8'-0"	OVERHEAD DOOR		EXTERIOR	BLACK METAL PANEL	
101	ENTRY	A	3'-6"	7'-6"	SWING	LOEWEN ALUMN CLAD WOOD; BLACK	EXTERIOR		
103	LIVING	C	15'-9 1/2"	9'-10 3/4"	SLIDING PATIO	LOEWEN ALUMN CLAD WOOD; BLACK	EXTERIOR		
104	DINING	D	8'-0"	7'-6"	SLIDING PATIO	LOEWEN ALUMN CLAD WOOD; BLACK	EXTERIOR		
105B	GUEST BEDROOM 1	B	4'-8"	7'-6"	SLIDING PATIO	LOEWEN ALUMN CLAD WOOD; BLACK	EXTERIOR		
105C	GUEST BEDROOM 1	B	5'-0"	7'-6"	SLIDING PATIO	LOEWEN ALUMN CLAD WOOD; BLACK	EXTERIOR		
202B	MASTER BEDROOM	B	7'-0"	7'-6"	SLIDING PATIO	LOEWEN ALUMN CLAD WOOD; BLACK	EXTERIOR		
207B	GUEST BEDROOM 2	B	7'-0"	7'-8"	SLIDING PATIO	LOEWEN ALUMN CLAD WOOD; BLACK	EXTERIOR		
003	LAUNDRY 1	F	2'-8"	7'-6"	SWING		INTERIOR		
004	BUNK ROOM	J	7'-0"	7'-6"	BARN DOOR DOUBLE		INTERIOR		
005	BUNK CLOSET	F	2'-0"	7'-6"	SWING		INTERIOR		
006	BATH	F	2'-6"	7'-6"	SWING		INTERIOR		
008A	GARAGE	F	3'-0"	7'-6"	SWING		INTERIOR	1 HOUR FIRE-RATED	
009	MECH	G	4'-0"	7'-6"	DOUBLE SWING		INTERIOR	1 HOUR FIRE-RATED	
105A	GUEST BEDROOM 1	F	2'-6"	7'-6"	SWING		INTERIOR		
106A	BATH 1	F	2'-4"	7'-6"	SWING		INTERIOR		
106B	BATH 1	F	2'-4"	7'-6"	SWING		INTERIOR		
202A	LOFT	F	2'-6"	7'-6"	SWING		INTERIOR		
203	MASTER BATH	F	2'-6"	7'-6"	SWING		INTERIOR		
205	MASTER BATH	H	2'-0"	7'-6"	POCKET		INTERIOR		
206	MASTER CLOSET	F	2'-6"	7'-6"	SWING		INTERIOR		
207A	GUEST BEDROOM 2	F	2'-8"	7'-6"	SWING		INTERIOR		
208	CLOSET 2	F	2'-4"	7'-6"	SWING		INTERIOR		
209	BATH 2	H	2'-4"	7'-6"	POCKET		INTERIOR		
211	LAUNDRY 2	I	5'-0"	7'-6"	DOUBLE SWING / LOUVERED		INTERIOR		

- DOOR NOTES:**
- DOOR INSTALLATION: INSTALL DOORS IN ACCORDANCE WITH MANUFACTURER'S INSTALLATION INSTRUCTIONS.
 - SEE ELEVATIONS FOR DOOR MULLION PATTERN.
 - DOOR HARDWARE TO BE BRUSHED NICKEL OR BRUSHED STEEL.
 - DOOR & WINDOW MANUFACTURER: LOEWEN ALUMN CLAD WOOD
 - VERIFY ROUGH OPENINGS WITH MANUFACTURER PRIOR TO FRAMING.

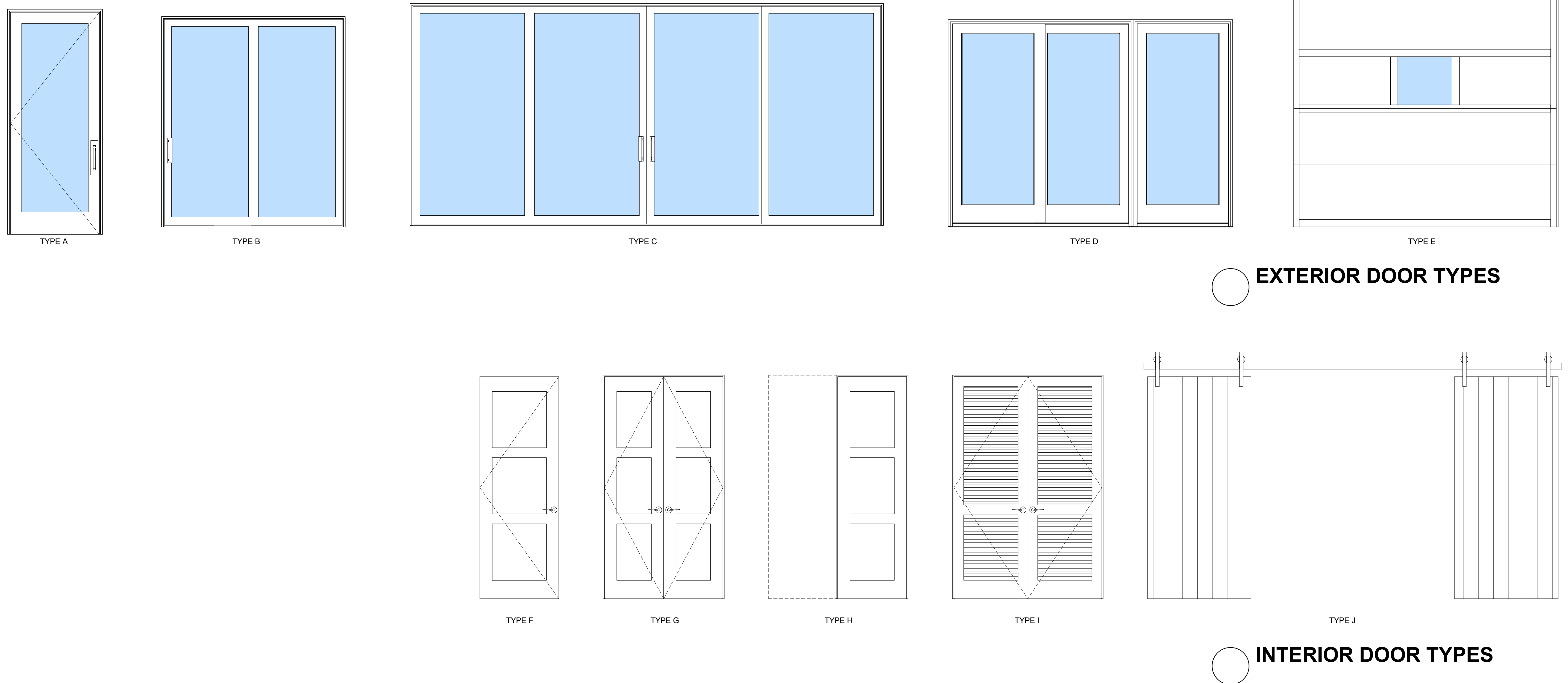

○ EXTERIOR DOOR TYPES

○ INTERIOR DOOR TYPES

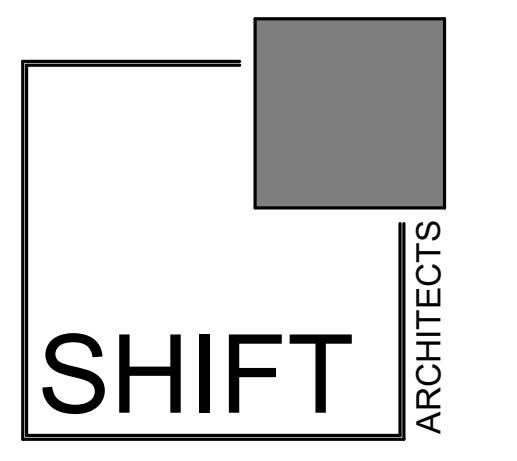

P.O. Box 3206
100 W. Colorado Suite 211
Telluride, Colorado 81435
p 970-728-8145
kristine@shift-architects.com
www.shift-architects.com

PROJECT ISSUE DATE:
02.01.21 DRB PRELIMINARY
SUBMITTAL

REVISIONS
NO. DATE DESC.

MOUNTAIN VIEW ESTATES UNIT 3
 162 SAN JOAQUIN RD. 3, MOUNTAIN VILLAGE, CO 81435
 UNIT 3 MOUNTAIN VIEW ESTATES, TOWN OF MOUNTAIN VILLAGE, SAN MIGUEL COUNTY, ACCORDING TO THE MAP RECORDED NOVEMBER 28, 2005 IN
 PLAT BOOK 1 AT PAGE 3573, AND AS DEFINED AND DESCRIBED IN THE DECLARATION OF COMMON INTEREST COMMUNITY FOR MOUNTAIN VIEW
 ESTATES, RECORDED NOVEMBER 28, 2005 UNDER RECEPTION NO. 379791 AND AS AMENDED BY INSTRUMENT RECORDED DECEMBER 5, 2018 UNDER
 RECEPTION NO. 456632, COUNTY OF SAN MIGUEL, STATE OF COLORADO.

DOOR SCHEDULE

SHEET NUMBER

A8.1

2/3/2021 9:23:31 AM

NOT FOR CONSTRUCTION

©shift architects

WINDOW NOTES:

1. WINDOW INSTALLATION: INSTALL WINDOWS IN ACCORDANCE WITH MANUFACTURER'S INSTALLATION INSTRUCTIONS.
2. SEE ELEVATIONS FOR WINDOW MULLION PATTERN.
3. WINDOW HARDWARE TO BE BRUSHED NICKEL OR BRUSHED STEEL.
4. VERIFY ROUGH OPENINGS WITH MANUFACTURER PRIOR TO FRAMING.
5. WINDOW MANUFACTURER TO VERIFY WINDOW SWINGS.
6. WINDOW MANUFACTURER TO PROVIDE SHOP DRAWINGS.
7. PROVIDE SCREENS FOR ALL OPERABLE WINDOWS.

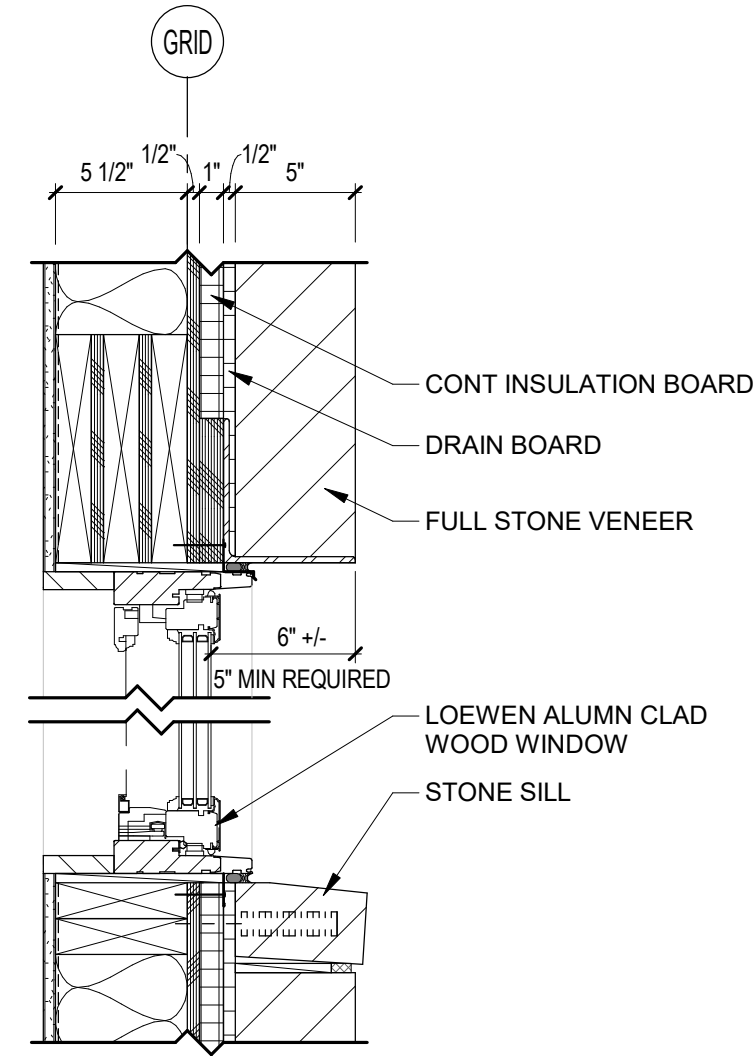

1 WINDOW HEAD/SILL STONE VENEER
1 1/2" = 1'-0"

WINDOW SCHEDULE

ROOM NUMBER	ROOM NAME	MARK	UNIT WIDTH	UNIT HEIGHT	TYPE MARK	TYPE	MANUFACTURER	COMMENTS
001	MUD ROOM	A	2'-6"	5'-6"	1	CASEMENT (1 WIDE)	LOEWEN ALUMN CLAD WOOD; BLACK	
001	MUD ROOM	A	2'-6"	5'-6"	1	CASEMENT (1 WIDE)	LOEWEN ALUMN CLAD WOOD; BLACK	
001	MUD ROOM	E	5'-0"	5'-6"	2	CASEMENT (2 WIDE)	LOEWEN ALUMN CLAD WOOD; BLACK	
003	LAUNDRY 1	D	2'-6"	3'-6"	1	CASEMENT (1 WIDE)	LOEWEN ALUMN CLAD WOOD; BLACK	
004	BUNK ROOM	E	5'-0"	5'-6"	2	CASEMENT (2 WIDE)	LOEWEN ALUMN CLAD WOOD; BLACK	
101	ENTRY	B	2'-6"	4'-6"	1	CASEMENT (1 WIDE)	LOEWEN ALUMN CLAD WOOD; BLACK	
102	KITCHEN	F	5'-0"	6'-0"	2	CASEMENT (2 WIDE)	LOEWEN ALUMN CLAD WOOD; BLACK	
103	LIVING	B	2'-6"	4'-6"	1	CASEMENT (1 WIDE)	LOEWEN ALUMN CLAD WOOD; BLACK	
103	LIVING	B	2'-6"	4'-6"	1	CASEMENT (1 WIDE)	LOEWEN ALUMN CLAD WOOD; BLACK	
103	LIVING	H	3'-10 1/2"	3'-10 1/2"	3	PICTURE (1 WIDE)	LOEWEN ALUMN CLAD WOOD; BLACK	
103	LIVING	H	3'-10 1/2"	3'-10 1/2"	3	PICTURE (1 WIDE)	LOEWEN ALUMN CLAD WOOD; BLACK	
103	LIVING	I	7'-9"	6'-3"	4	PICTURE (2 WIDE)	LOEWEN ALUMN CLAD WOOD; BLACK	
103	LIVING	I	7'-9"	6'-3"	4	PICTURE (2 WIDE)	LOEWEN ALUMN CLAD WOOD; BLACK	
103	LIVING	I	7'-9"	6'-3"	4	PICTURE (2 WIDE)	LOEWEN ALUMN CLAD WOOD; BLACK	
104	DINING	B	2'-6"	4'-6"	1	CASEMENT (1 WIDE)	LOEWEN ALUMN CLAD WOOD; BLACK	
104	DINING	B	2'-6"	4'-6"	1	CASEMENT (1 WIDE)	LOEWEN ALUMN CLAD WOOD; BLACK	
105	GUEST BEDROOM 1	B	2'-6"	4'-6"	1	CASEMENT (1 WIDE)	LOEWEN ALUMN CLAD WOOD; BLACK	
105	GUEST BEDROOM 1	B	2'-6"	4'-6"	1	CASEMENT (1 WIDE)	LOEWEN ALUMN CLAD WOOD; BLACK	
202	MASTER BEDROOM	A	2'-6"	5'-6"	1	CASEMENT (1 WIDE)	LOEWEN ALUMN CLAD WOOD; BLACK	
202	MASTER BEDROOM	A	2'-6"	5'-6"	1	CASEMENT (1 WIDE)	LOEWEN ALUMN CLAD WOOD; BLACK	
202	MASTER BEDROOM	E	5'-0"	5'-6"	2	CASEMENT (2 WIDE)	LOEWEN ALUMN CLAD WOOD; BLACK	
203	MASTER BATH	A	2'-6"	5'-6"	1	CASEMENT (1 WIDE)	LOEWEN ALUMN CLAD WOOD; BLACK	
203	MASTER BATH	G	5'-0"	2'-8"	2	CASEMENT (2 WIDE)	LOEWEN ALUMN CLAD WOOD; BLACK	
207	GUEST BEDROOM 2	J	7'-9"	6'-3"	4	PICTURE (2 WIDE)	LOEWEN ALUMN CLAD WOOD; BLACK	
209	BATH 2	C	2'-6"	4'-0"	1	CASEMENT (1 WIDE)	LOEWEN ALUMN CLAD WOOD; BLACK	

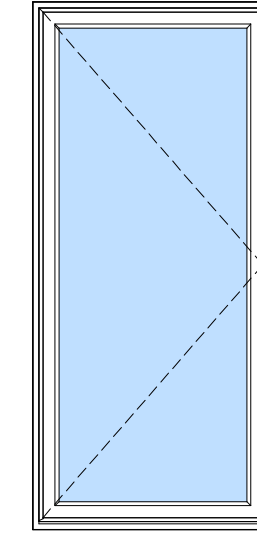

TYPE 1

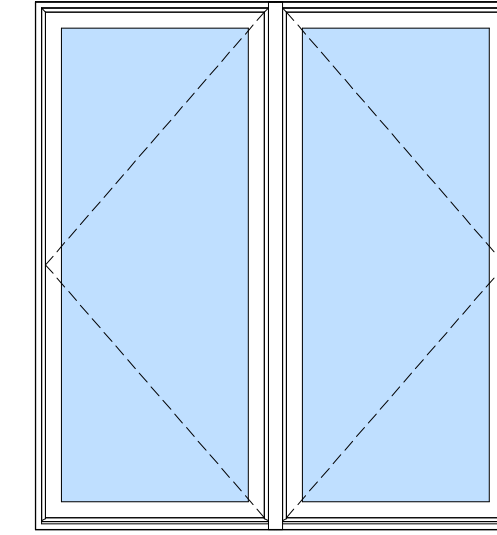

TYPE 2

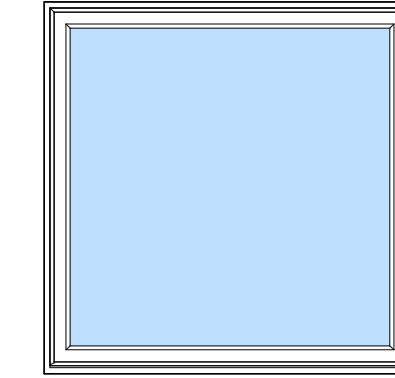

TYPE 3

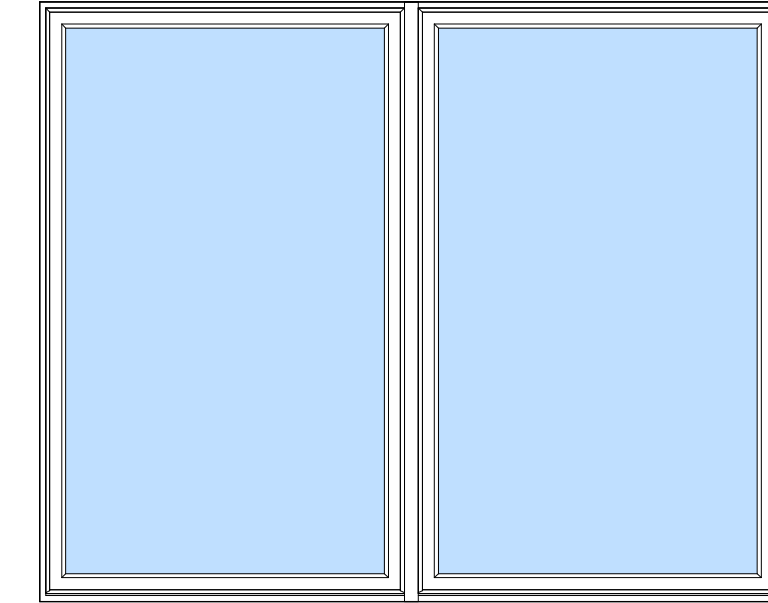

TYPE 4

WINDOW TYPES

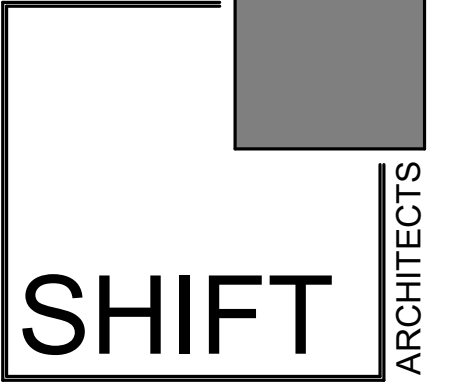

P.O. Box 3206
100 W. Colorado Suite 211
Telluride, Colorado 81435
p 970-728-8145
kristine@shift-architects.com
www.shift-architects.com

PROJECT ISSUE DATE:
02.01.21 DRB PRELIMINARY
SUBMITTAL

REVISIONS
NO. DATE DESC.

MOUNTAIN VIEW ESTATES UNIT 3
 162 SAN JOAQUIN RD. 3, MOUNTAIN VILLAGE, CO 81435
 UNIT 3 MOUNTAIN VIEW ESTATES, TOWN OF MOUNTAIN VILLAGE, SAN MIGUEL COUNTY, ACCORDING TO THE MAP RECORDED NOVEMBER 28, 2005 IN
 PLAT BOOK 1 AT PAGE 3573, AND AS DEFINED AND DESCRIBED IN THE DECLARATION OF COMMON INTEREST COMMUNITY FOR MOUNTAIN VIEW
 ESTATES, RECORDED NOVEMBER 28, 2005 UNDER RECEPTION NO. 379791 AND AS AMENDED BY INSTRUMENT RECORDED DECEMBER 5, 2018 UNDER
 RECEPTION NO. 456632, COUNTY OF SAN MIGUEL, STATE OF COLORADO.

WINDOW SCHEDULE

SHEET NUMBER

A8.2

2/3/2021 9:23:32 AM

NOT FOR CONSTRUCTION

©shift architects

EXTERIOR FIXTURE A:



LED OUTDOOR WALL LIGHT (9 TOTAL)

CALIBER MODEL "WS-W36610"	
FINISH:	BLACK
SIZE:	ONE-WAY LIGHT OPTION
MANUFACTURER:	WAC LIGHTING
WIDTH:	4.5"
HEIGHT:	10"
DEPTH:	4"
MATERIAL:	ALUMINUM HARDWARE W/ LENS DIFFUSER WEATHER RESISTANT POWDER COATED FINISH
WATTAGE:	11wLED
BULB:	1 X 11W, 120V LED MODULE, 3000K, 90CRI
DARK SKY:	YES
LED INFO:	
LUMENS:	735
LUMENS DELIVERED:	560
COLOR TEMPERATURE:	3000K
CRI:	90
DIMMABLE:	YES, 100%, 10% ELV
RATED LIFE:	72,000 HOURS
VOLTAGE:	120V
CERTIFICATION:	ETL & CETL WET LOCATION LISTED, IP 65, CEC TITLE 24

EXTERIOR FIXTURE B:



BK- Black Finish

EXTERIOR STEP AND WALL LIGHT (4 TOTAL)

WL-LED 100	
FINISH:	BLACK
MANUFACTURER:	WAC LIGHTING
ITEM:	WL-LED100-C-BK
MATERIAL:	DIE-CAST ALUMINUM
GLASS:	3000K
WIDTH:	5"
HEIGHT:	3"
LUMENS:	68
EFFICACY (lm/W):	8
CRI:	90
RATED LIFE:	50,000 HOURS
WATTAGE:	3.9W
DIMMABLE:	WITH ELECTRONIC LOW VOLTAGE (ELV) DIMMER
CERTIFICATION:	IP66, UL & cUL LISTED FOR WET LOCATIONS
LIGHT SOURCE:	PRIMARY BULB: X 3.90 WATTS INTEGRATED LED MODULE
VOLTAGE:	120V, DIRECT WIRING

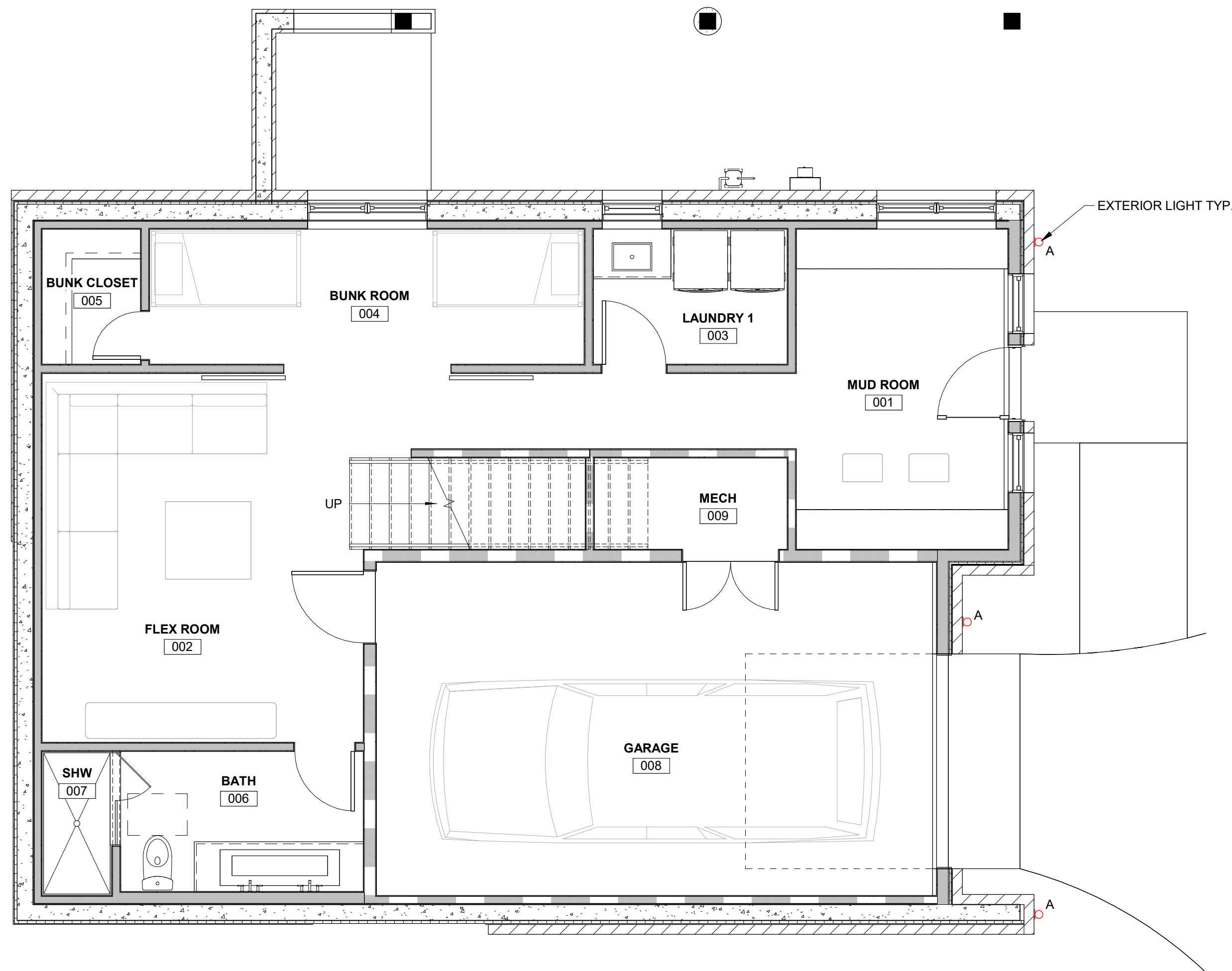

1 LOWER LEVEL
1/4" = 1'-0"



2 GROUND LEVEL
1/4" = 1'-0"

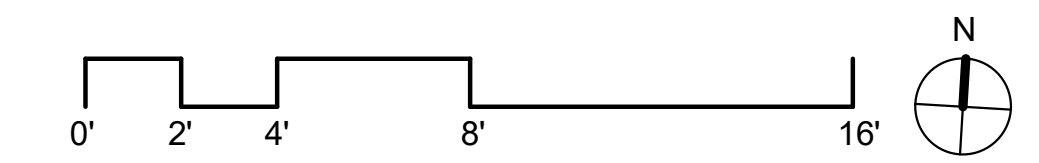

- LIGHTING NOTES:**
- FIELD VERIFY ALL LIGHTING LOCATIONS.
 - TYPICAL LIGHTING LOCATION AT STAIRS:
(1 EA) PER LANDING
(2 EA) PER RUN
 - CONTRACTOR SHALL TAKE CARE IN PLANNING ROUGH FRAMING LAYOUT AS IT RELATES TO THE NEED TO CENTER FIXTURES IN HALLWAYS, RECESSES AND OTHER AREAS WHERE RELATIONSHIPS DON'T OFFER ANY LATITUDE OR FIELD ADJUSTMENTS.
 - ALL RECESSED FIXTURES AT INSULATED CEILINGS TO BE IC RATED AND CERTIFIED AIR TIGHT CONSTRUCTION. ALL EXTERIOR FIXTURES, SHOWER FIXTURES AND FIXTURES OVER TUBS TO BE MARKED "SUITABLE FOR DAMP LOCATIONS".
 - LIGHTING SHALL BE IN ACCORDANCE WITH TOWN OF MOUNTAIN VILLAGE COMMUNITY DEVELOPMENT CODE 17.5.12 LIGHTING REGULATIONS
 - PROVIDE FULL CUT OFF FIXTURES WITH LED 10W 2500K-2700K BULBS PER CDC REQUIREMENTS.
 - MOUNT FIXTURES AT 7'-0" AFF MAX PER CDC REQUIREMENTS.

LIGHTING LEGEND

○ C1	RECESSED CAN	↕	DOUBLE HEADED MONO POINT
○ C2	RECESSED CAN; DIRECTIONAL	MS	MOTION SENSOR
○ C3	RECESSED CAN; WET LOCATIONS	○ P	PENDANT
○ EX	RECESSED CAN; EXTERIOR	--- UC	UNDER CABINET LED STRIP
✳	CEILING FAN	— R	RECESSED LED LIGHT
— C	2' LINEAR CLOSET FIXTURE	TL	TABLE LAMP RECEPTACLE
○ FN	EXHAUST FAN	FL	FLOOR LAMP RECEPTACLE
● FN	EXHAUST FAN WITH LIGHT	S	WALL MOUNTED SCONCE
▭ F	CEILING MOUNT FLUORESCENT LIGHT	ST	STEP LIGHT
⊕ CH	SURFACE MOUNT FIXTURE	2	TWO WAY SWITCH
⊕ CH	CHANDELIER	3	THREE WAY SWITCH
⊕ CH	MONO POINT FIXTURE	TV	TV OUTLET
		WG	WALL GRAZING
		X	EXTERIOR SCONCE
		---	FIXTURE LAYOUT GRID

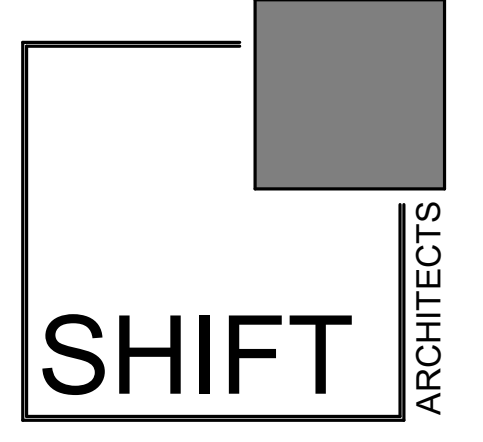

P.O. Box 3206
100 W. Colorado Suite 211
Telluride, Colorado 81435
p 970-728-8145
kristine@shift-architects.com
www.shift-architects.com

PROJECT ISSUE DATE:
02.01.21 DRB PRELIMINARY
SUBMITTAL

REVISIONS
NO. DATE DESC.

MOUNTAIN VIEW ESTATES UNIT 3
162 SAN JOAQUIN RD. 3, MOUNTAIN VILLAGE, CO 81435
UNIT 3 MOUNTAIN VIEW ESTATES, TOWN OF MOUNTAIN VILLAGE, SAN MIGUEL COUNTY, ACCORDING TO THE MAP RECORDED NOVEMBER 28, 2005 IN
PLAY BOOK 1 AT PAGE 3573, AND AS DEFINED AND DESCRIBED IN THE DECLARATION OF COMMON INTEREST COMMUNITY FOR MOUNTAIN VIEW
ESTATES, RECORDED NOVEMBER 28, 2005 UNDER RECEPTION NO. 379791 AND AS AMENDED BY INSTRUMENT RECORDED DECEMBER 5, 2018 UNDER
RECEPTION NO. 456632, COUNTY OF SAN MIGUEL, STATE OF COLORADO.

LIGHTING PLAN

SHEET NUMBER

LTG1.1

NOT FOR CONSTRUCTION

©shift architects

2/3/2021 9:23:36 AM

EXTERIOR FIXTURE A:



LED OUTDOOR WALL LIGHT (9 TOTAL)

CALIBER MODEL "WS-W36610"	
FINISH:	BLACK
SIZE:	ONE-WAY LIGHT OPTION
MANUFACTURER	WAC LIGHTING
WIDTH	4.5"
HEIGHT	10"
DEPTH	4"
MATERIAL	ALUMINUM HARDWARE W/ LENS DIFFUSER WEATHER RESISTANT POWDER COATED FINISH
WATTAGE	11wLED
BULB	1 X 11W, 120V LED MODULE, 3000K, 90CRI
DARK SKY	YES
LED INFO:	
LUMENS	735
LUMENS DELIVERED	560
COLOR TEMPERATURE	3000K
CRI	90
DIMMABLE	YES, 100%, 10% ELV
RATED LIFE	72,000 HOURS
VOLTAGE	120V
CERTIFICATION	ETL & CETL WET LOCATION LISTED, IP 65, CEC TITLE 24

EXTERIOR FIXTURE B:



BK- Black Finish

EXTERIOR STEP AND WALL LIGHT (4 TOTAL)

WL-LED 100	
FINISH:	BLACK
MANUFACTURER	WAC LIGHTING
ITEM	WL-LED100-C-BK
MATERIAL	DIE-CAST ALUMINUM
GLASS	3000K
WIDTH	5"
HEIGHT	3"
LUMENS	68
EFFICACY (lm/W)	8
CRI	90
RATED LIFE	50,000 HOURS
WATTAGE	3.9W
DIMMABLE	WITH ELECTRONIC LOW VOLTAGE (ELV) DIMMER
CERTIFICATION	IP66, UL & cUL LISTED FOR WET LOCATIONS
LIGHT SOURCE	PRIMARY BULB: X 3.90 WATTS INTEGRATED LED MODULE
VOLTAGE	120V, DIRECT WIRING

LIGHTING NOTES:

- FIELD VERIFY ALL LIGHTING LOCATIONS.
- TYPICAL LIGHTING LOCATION AT STAIRS:
(1 EA) PER LANDING
(2 EA) PER RUN
- CONTRACTOR SHALL TAKE CARE IN PLANNING
ROUGH FRAMING LAYOUT AS IT RELATES TO THE
NEED TO CENTER FIXTURES IN HALLWAYS,
RECESSES AND OTHER AREAS WHERE
RELATIONSHIPS DON'T OFFER ANY LATITUDE OR
FIELD ADJUSTMENTS.
- ALL RECESSED FIXTURES AT INSULATED CEILINGS
TO BE IC RATED AND CERTIFIED AIR TIGHT
CONSTRUCTION. ALL EXTERIOR FIXTURES,
SHOWER FIXTURES AND FIXTURES OVER TUBS TO
BE MARKED "SUITABLE FOR DAMP LOCATIONS".
- LIGHTING SHALL BE IN ACCORDANCE WITH TOWN
OF MOUNTAIN VILLAGE COMMUNITY DEVELOPMENT
CODE 17.5.12 LIGHTING REGULATIONS
- PROVIDE FULL CUT OFF FIXTURES WITH LED 10W
2500K-2700K BULBS PER CDC REQUIREMENTS.
- MOUNT FIXTURES AT 7'-0" AFF MAX PER CDC
REQUIREMENTS.

LIGHTING LEGEND

○ C1	RECESSED CAN	↕	DOUBLE HEADED MONO POINT
○ C2	RECESSED CAN; DIRECTIONAL	MS	MOTION SENSOR
○ C3	RECESSED CAN; WET LOCATIONS	○ P	PENDANT
○ EX	RECESSED CAN; EXTERIOR	--- UC	UNDER CABINET LED STRIP
✳	CEILING FAN	— R	RECESSED LED LIGHT
— C	2' LINEAR CLOSET FIXTURE	TL	TABLE LAMP RECEPTACLE
FN	EXHAUST FAN	FL	FLOOR LAMP RECEPTACLE
FN	EXHAUST FAN WITH LIGHT	S	WALL MOUNTED SCONCE
F	CEILING MOUNT FLUORESCENT LIGHT	ST	STEP LIGHT
⊕	SURFACE MOUNT FIXTURE	2	TWO WAY SWITCH
CH	CHANDELIER	3	THREE WAY SWITCH
⌞	MONO POINT FIXTURE	TV	TV OUTLET
		WG	WALL GRAZING
		X	EXTERIOR SCONCE
		---	FIXTURE LAYOUT GRID



1 UPPER LEVEL
1/4" = 1'-0"

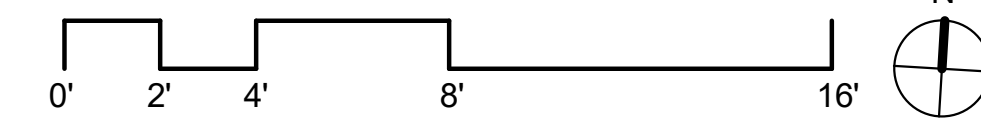

MOUNTAIN VIEW ESTATES UNIT 3

162 SAN JOAQUIN RD. 3, MOUNTAIN VILLAGE, CO 81435
 UNIT 3 MOUNTAIN VIEW ESTATES, TOWN OF MOUNTAIN VILLAGE, SAN MIGUEL COUNTY, ACCORDING TO THE MAP RECORDED NOVEMBER 28, 2005 IN
 PLAT BOOK 1 AT PAGE 3573, AND AS DEFINED AND DESCRIBED IN THE DECLARATION OF COMMON INTEREST COMMUNITY FOR MOUNTAIN VIEW
 ESTATES, RECORDED NOVEMBER 28, 2005 UNDER RECEPTION NO. 378791 AND AS AMENDED BY INSTRUMENT RECORDED DECEMBER 5, 2018 UNDER
 RECEPTION NO. 456632, COUNTY OF SAN MIGUEL, STATE OF COLORADO.

LIGHTING PLAN

SHEET NUMBER

LTG1.2

2/3/2021 9:23:37 AM

NOT FOR CONSTRUCTION

©shift architects

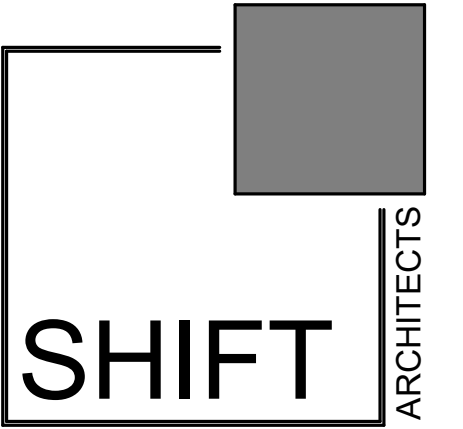

P.O. Box 3206
 100 W. Colorado Suite 211
 Telluride, Colorado 81435
 p 970-728-8145
 kristine@shift-architects.com
 www.shift-architects.com

PROJECT ISSUE DATE:
 02.01.21 DRB PRELIMINARY
 SUBMITTAL

REVISIONS
 NO. DATE DESC.

Staff Comments Lot 167R-3 162 San Joaquin Rd.

No public comment received as of 12/24/21

From: Finn KJome <FKJome@mtnvillage.org>

Sent: Monday, February 8, 2021 4:53 PM

To: Amy Ward <award@mtnvillage.org>

Subject: RE: Referral Lot 167, Unit 3, 162 San Joaquin Rd.

Hi Amy,

This lot did have all utilities stubbed out during the original development. They need to field very all existing utilities.

Finn



AGENDA ITEM 12
PLANNING & DEVELOPMENT SERVICE
PLANNING DIVISION
455 Mountain Village Blvd.
Mountain Village, CO 81435
(970) 728-1392

TO: Mountain Village Design Review Board
FROM: John Miller, Senior Planner
FOR: Design Review Board Public Hearing; March 4, 2021
DATE: February 22, 2021
RE: Staff Memo – Initial Architecture and Site Review, Lot 434

Work Session Overview

PROJECT GEOGRAPHY

Legal Description: LOT 434 TELLURIDE MOUNTAIN VILLAGE FILING 12 PLAT BK 1 PG 866 AS AMENDED AND RECORDED IN PLAT BK 1 PG 881 SAN MIGUEL COUNTY, STATE OF COLORADO

Address: 142 Touchdown Drive
Applicant/Agent: Chris Hawkins, Alpine Planning
Owner: Jennifer S. Birdwell Revocable Trust
Zoning: Single-Family
Existing Use: Vacant
Proposed Use: Single-Family
Lot Size: 0.717 Acres

Adjacent Land Uses:

- **North:** Single-Family
- **South:** Single-Family
- **East:** Active OS
- **West:** Single-Family

ATTACHMENTS

- Exhibit A: Application
- Exhibit B: Plan Set
- Exhibit C: Public / Referral Comments



Figure 1: Vicinity Map

Case Summary: Chris Hawkins of Alpine Planning (Applicant), working on behalf of the Jennifer S. Birdwell Revocable Trust (Owner), is requesting Design Review Board (DRB) approval of an Initial Architectural and Site Review (IASR) Application for a new single-family home on Lot 434, 142 Touchdown Drive. The Lot is approximately 0.717 acres and is zoned Single-Family. The overall square footage of the home is approximately 6,438 gross square feet and provides 4 interior parking spaces within the proposed garage.

The property is located at the intersection of Touchdown Drive and Highlands Way and consists of a forested parcel containing a number of existing slopes over 30% throughout the Lot. In addition, the lot borders TSG open space along the Galloping Goose ski run.

Applicable CDC Requirement Analysis: The applicable requirements cited may not be exhaustive or all-inclusive. The applicant is required to follow all requirements even if an applicable section of the CDC is not cited. ***Please note that Staff comments will be indicated by Italicized Text.***

Table 1

<u>CDC Provision</u>	<u>Requirement</u>	<u>Proposed</u>
Maximum Building Height	40' (gable) Maximum	39.68'
Maximum Avg. Building Height	35' (gable) Maximum	21.94'
Maximum Lot Coverage	40% Maximum	19.2%
General Easement Setbacks		
North	16' setback from lot line	21'-4"
South	16' setback from lot line	16'
East	16' setback from lot line	16'
West	16' setback from lot line	16'
Roof Pitch		
Primary		7:12
Secondary		9:12, 4.5:12, 2:12
Exterior Material**		
Stone	35% minimum	36.9%
Windows/Doors	40% maximum	24.5%
Parking	2 enclosed / 2 surface	3/1

Design Review Board Specific Approvals:

1. **Board Form Concrete**
2. **GE Encroachments**
3. **Metal Fascia**

Chapter 17.3: ZONING AND LAND USE REGULATIONS

17.3.12: Building Height Limits

Sections 17.3.11 and 17.3.12 of the CDC provide the methods for measuring Building Height and Average Building Height, along with providing the height allowances for specific types of buildings based on their architectural form. The proposed design incorporates both Gabled and Shed roof forms which are granted different height allowances in the CDC. Gabled roof forms are granted a maximum building height of 40 feet with shed roof forms limited to 35 feet. The maximum average height must be at or below 30 feet for shed roof forms and 35 feet for gable roof forms. The average height is an average of measurements from a point halfway between the roof ridge and eave. The points are generally every 20 feet around the roof. The maximum height is measured from the highest point on a roof directly down to the existing grade or finished grade, whichever is more restrictive.

Staff: As part of this application, the applicant has provided both a Maximum Building Height and Average Building Height analysis. Based on the heights provided, the applicant is 39.68 feet from the highest ridge to the grade below on the gabled portion of the home. Additionally, the applicant has provided a parallel plane analysis demonstrating that no portion of any shed roof forms penetrates the 35-foot parallel slope height allowance.

17.3.14: General Easement Setbacks

Lot 434 is burdened by a sixteen (16) foot General Easement (GE) which surrounds its perimeter. The CDC provides that the GE and other setbacks be maintained in a natural, undisturbed state to provide buffering to surrounding land uses. The CDC does provide for some development activity within the GE and setbacks such as Ski Access, Utilities, Address Monuments, and Fire Mitigation. All encroachments not listed above will require encroachment agreements between the property owner and the Town.

Staff: The proposal includes several GE encroachments that fall into the above category of permitted GE development activity including the following:

- *Driveway: The Driveway as shown currently takes access from the roundabout at the intersection of Touchdown Drive and Highlands Way.*
- *Address Monument: Although the address monument has not been shown at this time, it is assumed that the monument will be located within either the GE or Town ROW and will require an associated encroachment agreement.*
- *Utilities: The shallow utilities connections are currently located within the GE of Lot 434. The applicant has proposed connecting to those services and trenching them across the motor court to the home. The water and sewer are located within Touchdown Drive / Highlands Way and the applicant is proposing to connect to these services on opposite sides of the lot. It appears based on the civil drawings that the GE will need to be disturbed along both frontages in order to accommodate sewer grade.*

Staff: There are additional encroachments into the GE as shown within this proposal. These will require the DRB make a determination that this is appropriate. If not, then the applicant shall revise the plans to remove non-permitted GE encroachments.

- *Motor Court: The applicant has proposed a motor court and a portion of this area is located within the GE. Although not explicitly shown, this area could be used for surface parking which is not allowed by the CDC without approval by the DRB.*
- *Roof Overhang: The roof timbers over the Trash/Bike Enclosure create a vertical plane encroachment into the GE.*
- *Patio: The Patio along the southern façade of the home encroaches into the GE. This encroachment includes a retaining wall, a portion of a fireplace, and hardscape patio area.*

Chapter 17.5: DESIGN REGULATIONS

17.5.4: Town Design Theme

The Town of Mountain Village has established design themes aimed at creating a strong image and sense of place for the community. Due to the fragile high alpine environment,

architecture and landscaping shall be respectful and responsive to the tradition of alpine design – reflecting elements of alpine regions while blending influences that visually tie the town to mountain buildings. The town recognizes that architecture will continue to evolve and create a regionally unique mountain vernacular, but these evolutions must continue to embrace nature and traditional style in a way that respects the design context of the neighborhoods surrounding the site.

Staff: The home appears to blend well into the existing design theme of the Mountain Village given its strong material palette of stone, hewn timbers, barnwood siding, and metal accents. With that, there are certain aspects of the home that staff wants to discuss as part of this memo in order to understand the DRB's level of comfort.

- *Board Form Concrete Piers – The applicant is proposing to incorporate board form concrete into the foundation elements of the exterior decks. In the past, the DRB has preferred these elements to be faced with stone or metal.*
- *Exterior Decks: Generally, the deck design aligns with the design theme of other homes in the village with the exception of the large viewing platform that is elevated off of the rear of the home. Staff is not aware of any other examples of elevated platforms that are similar to this design. The DRB needs to determine the appropriateness of this design feature.*
- *Exposed wood / timber at or near grade: While the home does appear grounded, there are areas of the home where you have exposed timbers and wood siding at or in close proximity to the ground. This could be problematic over the long term with snow and water damage that could occur.*

It appears based on the applicant's submittal that the material palette for the project blends well with both the surrounding community, as well as the overall modern mountain vernacular, but the DRB must determine if the above items are appropriate. If they are not, the then applicant should revise accordingly.

17.5.5: Building Siting Design

The CDC requires that any proposed development blend into the existing landforms and vegetation.

Staff: The building siting for the proposed design is largely driven by both the shape and topography of the lot. Due to the topography, the home has been pushed towards the road frontages for a flatter homesite and access to the ski area. If the home was required to be pushed towards the rear of the lot, it would impact the site much more through grading and disturbances. The home, due to the existing grades of the road and landscaping berm appears to be visually subordinate to the existing landforms and vegetation that surrounds it. The motor court as proposed will require a large retaining wall - it may be worthwhile to better understand alternatives to this proposed parking plan to determine if the disturbance can be reduced and/or surface parking could be better provided without the use of a motor court.

17.5.6: Building Design

Staff: The CDC requires that building form and exterior wall forms portray a mass that is thick and strong with a heavy grounded foundation. In order to accomplish this, the applicant is proposing a warm grey "cottonwood" limestone siding in a 2'x4' buff tile pattern. The proposed siding is a bleached grey barnwood siding which is proposed in

different widths for vertical and horizontal arrangements (4" and 12", respectively). In addition to the siding, a prominent element of the home is the exposed vintage timbers. Overall, the contrast of the wood and arrangement of the stone appears to complement the design. Based on the plans provided, the applicant is meeting all materials requirements for Stone and Glazing.

Window and door trim are proposed as charcoal black product, but more detail should be provided related to the door design and garage door design prior to final review. The proposed roofing material is a rusted steel product, and the fascia of the home will match. According to the CDC, the use of metal fascia is a specific approval and the DRB will need to grant this approval as part of this application. The CDC allows for rusted standing seam roofing materials and this appears to meet that requirement. This material will need to be treated prior to produce rust prior to issuance of a CO.

Additionally, the home includes a detached garage that is approximately 484 square feet. The CDC allows for accessory structures no larger than 500 square feet and allows for detached garages for single-family residences. The garage aligns materially with the main home and complements the site well.

The applicant has not proposed any snowmelt at this time, but it is anticipated that this home will have exterior snowmelt. Prior to final, the applicant shall revise these plans to detail areas of exterior snowmelt and the associated square footages.

17.5.7: Grading and Drainage Design

Staff: The applicant has provided a grading and drainage plan in accordance with the CDC requirements. The siting of the home has enabled the design to largely minimize grading impacts on the Lot with the majority of the grading occurring in the area around the driveway and the rear of the home. The project includes positive drainage away from the home, but it should be noted that the existing landscaping berm along Touchdown Drive does limit the ability for the water to flow away from the home and instead this has necessitated the flow line to traverse the front of the home to a culvert under the driveway.

17.5.8: Parking Regulations

Staff: The CDC requires all single-family developments provide two interior and two surface parking spaces. The applicant has shown a total of 3 interior spaces but has not indicated on the plan set the location of the single surface parking space described in the narrative. Based on the motor court design, it appears that there would be adequate surface parking, but the following items should be noted:

- Because the parking area / motor court is partially located within the GE, the DRB will need to grant specific approval of the GE encroachments and parking within this area. It may be preferable to the applicant to designate surface parking areas that are not within the GE and/or redesign the motor court to remove the encroachment into the GE. As of now, there is no delineation between these areas and it's unclear to staff what would prohibit parking within the GE as currently shown.*
- The applicant has indicated within the narrative that 3 interior spaces and 1 exterior space meets the requirements of the CDC. Staff does not believe this to be true as its specifically stated that two surface spaces are required. In order for this request to meet the code, regardless of the motor court design and location, the DRB would need to grant approval for either*

tandem parking or waive the requirement for surface parking as permitted by the CDC. These provisions are intended and allowed for smaller lots less than 0.75 acres with unique site conditions such as steep slopes and unique shaped lots. Staff is not opposed to this option, but it should be discussed in more detail at the public hearing.

17.5.9: Landscaping Regulations

The applicant has provided a conceptual landscaping plan to for initial review. This plan demonstrates planting locations, revegetation notes, and other general requirements. Prior to final review, the plan shall be revised to include irrigation notes and locations. In addition, the applicant shall remove the limber pines shown in the wildfire zone 1. If the conifer species are intended to screen the home, then they shall be included in the drip line buffer of the home with zones 1 and 2 adjusting accordingly.

17.5.11: Utilities

Staff: All utilities are currently located within the Touchdown Dr/Highlands Way ROW and will only require connections from the road to the home. The applicant shall work with the Public Works Director before the final review to determine the specific locations of the connections for the home as these locations are conceptual only.

17.5.12: Lighting Regulations

Staff: The applicant has not provided a preliminary lighting plan at this time. It should be noted that the Lighting Plan is not required at IASR.

17.5.13: Sign Regulations

Staff: The applicant has not provided details on the address monument at this time. Prior to final review, the plans should be modified to demonstrate location, design, lighting, and all other standards of the CDC.

Chapter 17.6: SUPPLEMENTARY REGULATIONS

17.6.1: Environmental Regulations

Staff: Fire Mitigation and Forestry Management: The majority of the existing vegetation on the site is mature aspen trees. Staff does recommend that the applicants thin diseased and dying trees, but encourages the remaining healthy trees be maintained as they do not present a fire risk in Zone 2.

Steep Slopes: The building site does contain steep slopes and the applicant has intentionally designed the home to limit the impacts to those areas. This does result in the home being pushed towards the roadway but this is preferable to greater site disturbance on the steep slopes.

17.6.6: Roads and Driveway Standards

Staff: Although not shown on the plans explicitly, the driveway as shown meets the CDC standards with 12 feet width and 2-foot shoulders on each side. The maximum grade of the driveway appears to be approximately 3.5%. The CDC does not discuss motor courts, but staff believes this to be an extension of the driveway and as such needs to see additional grade information for this area. Currently, the civil plans only show the grade for the 50 feet of driveway from the ROW to the motor court. The retaining walls associated with the motor court do meet the requirements of the CDC for maximum heights.

It should also be noted that because of the location and grade of the driveway, the applicant is proposing a small portion of Highlands Way be sawcut and removed. This

modification to the roadway and Town ROW must be approved by the Public Works Director prior to final review.

17.6.8: Solid Fuel Burning Device Regulations

Staff: The applicant has indicated that the proposed home does include fireplaces and unless the owners procure a fireplace permit, these must operate on natural gas. Prior to Final Review, these plans should be revised to explicitly state that they are natural gas burning fireplaces.

Chapter 17.7: BUILDING REGULATIONS

17.7.19: Construction Mitigation

Staff: The applicant has not submitted a construction mitigation plan for this project but based on the location and topography of the Lot, staff believes this plan will be required to be phased in a way that allows for some parking along Touchdown Drive to occur as the parking and access to the Lot is developed. Once this occurs, the majority of the construction impacts can be shifted to the Lot rather than the ROW.

Staff Recommendation: Staff recommends the DRB approve the Initial Architectural and Site Review for Lot 434, 142 Touchdown Dr.

Staff Note: *It should be noted that reasons for approval or rejection should be stated in the findings of fact and motion.*

Proposed Motion:

If the DRB deems this application to be appropriate for approval, Staff requests said approval condition the items listed below in the suggested motion.

I move to approve the Initial Architectural and Site Review for a new single-family home located at Lot 434, 142 Touchdown Drive, based on the evidence provided within the Staff Report of record dated February 22, 2021, with the following and Specific Approvals:

Design Review Board Specific Approvals:

- 1) *Board Form Concrete*
- 2) *GE Encroachments, including parking*
- 3) *Metal Fascia*

And, with the following conditions:

- 1) Prior to submittal for a Final Architectural Review, the applicant shall either revise the motor court or provide an alternative analysis to demonstrate that the required GE encroachments cannot be addressed through minor modifications to the design of the home and parking area.
- 2) Prior to submittal for a Final Architectural Review, the applicant shall provide written sign off from Public Works for the removal of the portion of Highlands Way.
- 3) Prior to submittal for a Final Architectural Review, the applicant shall revise the landscaping plan to include irrigation details, and the Wildfire Mitigation plans to either remove coniferous species from Zone 1 or include within the dripline of the home.
- 4) Prior to submittal for a Final Architectural Review, the applicant shall demonstrate all areas of exterior snowmelt.
- 5) Prior to submittal for a Final Architectural Review, the applicant shall provide design and location details for the address monument, to include lighting details.

- 6) Prior to the submittal for a Final Architectural Review, the applicant shall provide an updated landscaping plan providing additional irrigation details.
- 7) Prior to the submittal for a Final Architectural Review, the applicant shall provide a detailed lighting plan to include specific fixture cut sheets, dimmer switch details, and a photometric study of the Lot demonstrating compliance with the CDC lighting standards.
- 8) Prior to the issuance of a building permit, the applicant shall field verify all utilities and submit a revised utility plan to the public works director identifying the location of utilities and connection points.
- 9) Consistent with town building codes, Unenclosed accessory structures attached to buildings with habitable spaces and projections, such as decks, shall be constructed as either non-combustible, heavy timber or exterior grade ignition resistant materials such as those listed as WUIC (Wildland Urban Interface Code) approved products.
- 10) Prior to issuance of a CO, the property owner will enter into a General Easement Encroachment Agreement, as applicable, with the Town of Mountain Village for the general easement encroachments approved.
- 11) A monumented land survey shall be prepared by a Colorado public land surveyor to establish the maximum building height and the maximum average building height.
- 12) A monumented land survey of the footers will be provided prior to pouring concrete to determine there are no additional encroachments into the GE.
- 13) Prior to the Building Division conducting the required framing inspection, a four-foot (4') by eight-foot (8') materials board will be erected on site consistent with the review authority approval to show:
 - a. The stone, setting pattern and any grouting with the minimum size of four feet (4') by four feet (4');
 - b. Wood that is stained in the approved color(s);
 - c. Any approved metal exterior material;
 - d. Roofing material(s); and
 - e. Any other approved exterior materials

/jjm

The Refuge



Lot 434 Design Review Process Application Initial Architecture and Site Review



Uncompahgre
Engineering, LLC



Site Context and Design

The Jennifer S. Bridwell Revocable Trust (“Owner”) is the owner of Lot 434 Mountain Village Filing No. 12 that has a parcel number 477904112434 (“Site”) that is currently vacant. The Owner intends to build a new single-family home on the Site that is located in the Single-family Zone District.

The Site is located east of OSP-41 that borders the Lower Galloping Goose Ski Run. The Site is a unique 0.717 acre triangle-shaped lot that is characterized by a bermed road cut for Touchdown Drive; a bowl-like ravine with slopes that are 30% or greater; and a declining aspen forest that has very little new tree regeneration. The Site has a low USGS topographic elevation of 9480 and a high elevation of 9528 for overall elevation gain of 48 feet.

The design intent of the new home is to minimize the impacts on the existing terrain; enhance the aspen forest outside of the home area; and maximize views for the home by locating it at the highest portion of the Site along Touchdown Drive. The design intent is to create a contemporary mountain refuge for the Owner that pays homage to traditional building forms with primary gable roof forms and secondary shed roof forms. The home is also sited to provide access to key Site views and to provide the best possible ski-in/ski-out access.

The DRB conducted a worksession on the proposed home on December 3, 2020. The Owner and development team appreciate the input received and revised the plans based on the DRB comments as presented in the initial review plan set.

Project Geography

Geography and Zoning Requirements		
	Existing/Requirement	Proposed (Approx.)
Lot Size	0.717 acres	No Change
Floor Area (Gross)	No floor area limit	5,091 sf livable 1,347 sf garage/mechanical
Zone District	Single-family Zone District	No Change
Maximum Building Height	35' + 5' for Gabled Roofs	39.68'
Maximum Average Building Height	35'	21.94' (Compliant by 8.05')
Lot Coverage	40%	19.2%
Setbacks		
Front - West	16 Feet	16'
Rear - East	16 Feet	16'
Side - North	16 Feet	21'-4"
Side - South	16 Feet	16'
Parking	2 enclosed spaces + 2 unenclosed	3 enclosed + 1 unenclosed

Steep Slope Regulations

As shown in Figure 2, the site has steep slopes greater than 30% on the eastern portion, southern portion and adjacent to Touchdown Drive on the eastern and north eastern boundaries. The steep slopes along Touchdown Drive were created by the road construction that essentially left a man made berm on the Site as shown in Figure 3. The steep slopes on the north side of the Site were created from the construction of Highlands Way.



Figure 1. The Site

Section 17.6.1(C)(2)(a) of the Community Development Code (“CDC”) states that:

“Building and development shall be located off slopes that are thirty percent (30%) or greater to the extent practical.

i. In evaluating practicable alternatives, the Town recognizes that it may be necessary to permit disturbance of slopes that are 30% or greater on a lot to allow access to key viewsheds, avoid other environmental issues, buffer development and similar site-specific design considerations.”

The development of the Site necessitates disturbance of steep slopes that are 30% or greater to allow access to key viewsheds while also avoiding most of the main steep slope areas in the bowl-like ravine. Our comments on compliance with the Steep Slope Regulations are shown in *italics*.

CDC Section 17.6.1(C)(2)(c) states:

“The review authority shall only allow for disturbance to slopes thirty percent (30%) or greater if it is demonstrated that there is not a practicable alternative to avoiding such activities and if the following criteria are met:”

i. The proposed steep slope disturbance is in general conformance with the Comprehensive Plan. *The proposed home is in general conformance with the Mountain Village Comprehensive Plan because it envisions Lot 434 with single-family land uses, and the new home will not adversely impact the environment.*

ii. The proposed disturbance is minimized to the extent practical. *The impact to the steep slope areas has been minimized to the extent practical with the home designed to fit into the current topography of the site.*

iii. A Colorado professional engineer or geologist has provided: (a) A soils report or, for a subdivision, a geologic report. *Trautner Geotech has prepared a soils report for the Site that will be utilized by the civil and structural engineers for the design of the home and associated improvements.*

(b) An engineered civil plan for the lot, including grading and drainage plans. *Uncompahgre Engineering designed the grading and drainage civil plan in coordination with Tommy Hein Architects.*

iv. And the proposal provides mitigation for the steep slope development in accordance with the engineered plans. *Impacts to steep slope areas are minimized by limiting the areas of grading; sensitive building design; and an erosion control plan and a revegetation plan.*

It is not practicable to avoid all steep slope areas due to the extent of such on the Site. Thus, there is no practicable alternative to avoiding disturbance to the steep slopes which is necessary to allow for the reasonable use of the property. The building design minimizes disturbance to steep slope areas by locating the home at the top of the site away from the bowl-like ravine.

General Easement (GE)

The Site has a narrow building area due to steep slope constraints and the need to access the Site's stunning views. The proposed Site development is seeking the following encroachments into the General Easement ("GE"):

1. Ski-in/Ski-out access grading retaining wall that is also proposed for an eastern terrace with an outdoor fireplace built into the wall.
2. Driveway, address monuments, relocated utility pedestals/transformer.

Community Development Code (CDC) Section 17.3.14(E) expressly allows the driveway and address monument and utilities to be placed in the GE.

CDC Section 17.3.14(F) states that the DRB may waive the General Easement setback or other setbacks and allow for prohibited activities provided such activities meet the following criteria, with our comments shown in *italics*:

1. The applicant has demonstrated that avoiding grading and disturbance in the general easement setback would create a hardship, and there is not a practicable alternative that allows for reasonable use of the lot. *The topography of the site with the bowl-shaped ravine and steep slopes and need to access views limit development to the upper portion of the Site adjacent to the western and southern GE. The Site is a ski-in/ski-out lot with a narrow area for ski access that allows for easier traversing to and from the ski run to the east. The proposed retaining wall in the western and southern GE is primarily designed to provide for this ski access to the home and full solar access to the terrace. The ski-in/ski out access allows for the consideration of the eastern ski terrace in the GE as a flat space that allows for putting on and taking off snow riding gear and also a nice sun terrace/snow beach for eastern and southern sun with an outdoor amenity space. We would argue that providing ski access and solar access are a key part of allowing reasonable use for the Site, and there is not a practicable alternative to avoiding the GE. This ski access provides for both terrace and ski lounge access at the lower level. The berm grading along Touchdown further necessitates the proposed retaining wall as shown as a natural progression of the home design sited and nestled adjacent to the GE to access the views.*

2. The disturbance in the general easement setback is due to natural features of the site, such as steep slopes, wetlands and streams. *The proposed improvements in the GE are due to the topography of the site with the bowl-shaped ravine and steep slopes and need to access views limit development to the upper portion of the Site adjacent to the western and southern GE. The berm grading for Touchdown further necessitates a wall in the GE as proposed.*

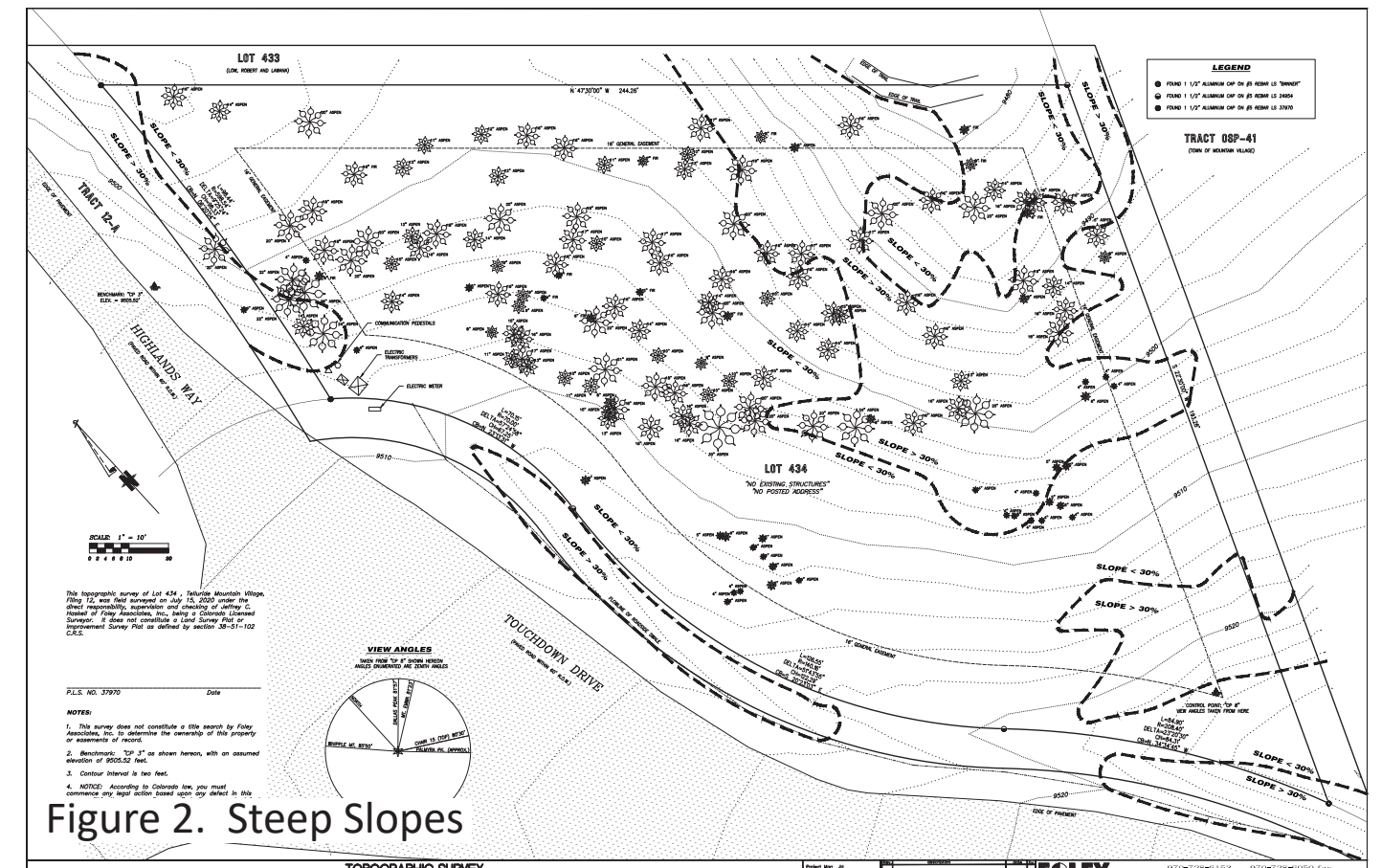

Figure 2. Steep Slopes



Figure 3. Touchdown Berm

3. No unreasonable negative impacts result to the surrounding properties. *The GE encroachment does not result in negative impacts to adjacent properties because it is adjacent to either the public Touchdown Right-of-Way or the public open space. The ski access retaining wall and terrace are located into what appears to be a human-made berm that was created by grading for Touchdown Drive construction. The property owners to the south and west, and motorists, pedestrians and cyclists on the road should not readily see the retaining wall or the terrace, with the proposed landscaping providing additional buffering along the human made berm. The closest home to the east is located over 340 feet away. There will not be any unreasonable, negative impacts to surrounding homes. Landscaping is proposed in the western GE to soften the architectural design for the Sharp Residence to the west and for people using the Touchdown Drive Right-of-Way.*

4. The general easement setback or other setback will be revegetated landscaped in a natural state. *Revegetation and landscaping are proposed in the GE as shown on the site and landscaping plans.*

5. The Public Works Department has approved the permanent above-grade and below-grade improvements. *This site proposal approval will be contingent upon receiving the approval from the Public Works Department.*

6. The applicant will enter into an encroachment agreement with the Town with the form and substances prescribed by the Town. *The Owner agrees to enter into an encroachment agreement with the Town in form acceptable by the Town.*

7. Encroachments into the general easement setback or other setbacks are mitigated by appropriate landscaping, buffering and other measures directly related to mitigating the encroachment impacts. *The landscaping plan proposed native species to be planted adjacent to the encroachment as shown on the landscaping plan that providing buffering to the public from the right of way.*

Landscaping

The primary goal of the landscaping plan is to retain as much of the existing vegetation as possible. Where disturbance is necessary, or as is the case of the General Easement, where the site is bare and devoid of vegetation, the proposed landscaping consists of native species that will blend into the existing character of the neighborhood. They are also species proposed that will thrive in the high alpine environment and mature into healthy vegetation. The proposed landscaping plan is shown on Sheet L1.0 through L4.0. The landscaping plan is proposing the use of 5 narrow leaf cottonwoods; 24 aspens; 7 limber pines; 3 skyland spruces; 41 shrubs; and ornamental grasses and perennials. Revegetation will be provided by a native grass seed mix. The Owner intends to retain a qualified forester to evaluate the Site and determine if the aspen forest can be managed to regenerated new aspen growth. A plan for such aspen regeneration may be submitted with the Final Architectural Review submittal.

Design Regulation Compliance

Mountain Village Design Theme. The proposed design meets the Mountain Village Design Theme. The project has been designed to sensitively fit the Site in order to minimize impacts to steep slopes and trees. The natural features of the site have informed the design of the home. The proposed home design is respectful and responsive to the tradition of alpine design with sturdy building forms, primary gable roof forms, secondary shed roof forms and a heavy grounded base. The massing is simple and form and is designed into the existing topography.

Building Siting Design. The home has been sited to blend into the existing landscape and landforms.

Building Design. The addition has been designed with a stone and board form concrete base that provides a grounded building form to withstand high alpine conditions. The overall building form is simple in design. The roof has been designed with a composition of multiple forms that emphasize sloped plans, varied ridge lines and vertical offsets. The proposed standing seam steel roof provides a durable roof material that will withstand



the high alpine climate conditions. Exterior materials are provided consistent with the Design Regulations as presented on Sheet A3.0. The exterior colors harmonize with the natural landscape and are natural, warm and subtle. Windows have been designed to be integral part of the structure's complete design and in accordance with the window regulations.

Grading Design. Grading has been designed to relate to and blend into the surrounding topographic landscape.

Parking Regulations. The proposal provides three (3) interior garage spaces and one (1) exterior surface spaces which meets the Parking Regulation requirements.

Exterior Material & Roof Design

The proposed home is designed with the following exterior materials:

- Cottonwood Limestone (36.9% or greater)
- 4" Vertical Bleached Grey Barnwood Siding
- Board Form Concrete
- Steel Windows and Doors (24.5% Fenestration)
- Standing Seam Rusted Steel Roof
- Vintage Wood Timbers
- Exposed Steel Structure

Lighting

The lighting plan will be submitted for during Final Plan Review consistent with the Design Review Process submittal requirements.

EXTERIOR MATERIALS				
				
MATERIAL PALLETTE	BLEACHED GREY BARNWOOD NATURAL - ROUGH VERTICAL SIDING AND SOFFITS - 4" BOARDS HORIZONTAL SIDING - 12" BOARDS MILLED, BUTT JOINTS, 1/4" DARK STAIN REVEAL.	W1 	STONE VENEER "COTTONWOOD" LIMESTONE 4-5" THICK NEUTRAL WARM GREY LARGE BLOCK PATTERN	S1 
			VINTAGE WOOD TIMBERS ROUGH-Hewn FADED WITH LIGHT WEATHERPROOF STAIN APPROX SIZE PER PLAN	W2 
				F1 STEEL WINDOWS & DOORS PAINTED CHARCOAL BLACK PER SCHEDULE
				DYNAMIC

EXTERIOR MATERIALS				
				
R1 ROOFING STEEL - RUSTED PATINA STANDING SEAM - 16" RIMS O.C.	S2 FLAGSTONE PATIO "COTTONWOOD" LIMESTONE 4-5" THICK NEUTRAL WARM GREY BUFF TILE PATTERN 2' X 4'	C1 BOARDFORM CONCRETE HIGHLY TEXTURED NEUTRAL WARM GREY	M1 EXPOSED STEEL STRUCTURE W, C, OR 3/16 BENT PLATE STEEL, PENETRICK PATINA FINISH BLACK FOR INTERIOR, PAINTED BROZE PATINA FOR EXTERIOR	





Tommy Hein
ARCHITECTS



Uncompahgre
Engineering, LLC



LOT COVERAGE & FLOOR AREA CALCULATIONS		
STANDARDS	REQUIRED	PROPOSED
LOT COVERAGE		
LOT AREA (S.F. AND ACREAGE)		0.72 ACRES= 31,239.78 S.F. MAX COVERAGE = 12,4895.91 S.F. COVERAGE SF= 5,985.0 S.F. COVERAGE %= 19.2% (19.2% IS 20.8% BELOW THE ALLOWABLE 40%)
LOT COVERAGE	<40%	
FLOOR AREA CALCULATIONS		
		SHEET A2.0 FOR ALL AREA CALCULATIONS
MISC REQUIREMENTS		
BUILDING SETBACKS	16'	- SEE A1.1 FOR BUILDING SETBACKS
BUILDING HEIGHT - MAXIMUM - AVERAGE	- 35' + 5' - 30'	- SEE A1.3 - SEE A1.3
NUMBER OF UNITS BY TYPE	- 1 RESIDENTIAL	- 1 RESIDENTIAL
PARKING SPACES - ENCLOSED - SURFACE	- 2 - 2	- 2 - 2
EXTERIOR MATERIALS	-SEE A3.0	-SEE A3.0
CODE SUMMARY		
ZONING - SINGLE FAMILY RESIDENTIAL BUILDING CODE - IRC-2012 DESCRIPTION - 3.0 STORY OCCUPANCY CLASSIFICATION - IRC 1&2 AUTOMATIC FIRE SPRINKLERS NFPA13D – SPRINKLERED GREATER THAN 3,600 S.F. FIRE RESISTIVE RAITING SHAFT ENCLOSURES – 1HR. EXIT ENCLOSURE RATING 1 HR. ELEVATOR SHAFT N/A		
REGULATORY COMPLIANCE		
THE CONTRACTOR SHALL ENSURE THAT THE WORK AND CONSTRUCTION ADMINISTRATION PROCESSES COMPLY WITH ALL APPLICABLE GOVERNMENTAL AND PRIVATE REGULATIONS, INCLUDING BUT NOT LIMITED TO THE TOWN OF TELLURIDE LAND USE CODE (LUC), DESIGN GUIDELINES, HISTORIC AND ARCHITECTURAL REVIEW COMMISSION (HARC) CONDITIONS, CERTIFICATES OF APPROPRIATENESS (CAS) AND IMPACT STATEMENTS; THE TOWN OF MOUNTAIN VILLAGE COMMUNITY DEVELOPMENT CODE (CDC) AND DESIGN REVIEW BOARD (DRB) CONDITIONS; SAN MIGUEL COUNTY BUILDING REGULATIONS; AND ALL COVENANTS, CONDITIONS & RESTRICTIONS, DECLARATIONS, ARCHITECTURAL GUIDELINES AND RULES AND REGULATIONS ESTABLISHED BY ANY PRIVATE OWNERS ASSOCIATIONS THAT GOVERN THE PROJECT SITE		

GENERAL NOTES

CONTRACT DOCUMENTS:
 CONTRACT DOCUMENTS CONSIST OF THE AGREEMENT, GENERAL CONDITIONS, SPECIFICATIONS, AND DRAWINGS, WHICH ARE COOPERATIVE AND CONTINUOUS. WORK INDICATED OR REASONABLY IMPLIED IN ANY ONE OF THE DOCUMENTS SHALL BE SUPPLIED AS THOUGH FULLY COVERED IN ALL. ANY DISCREPANCIES BETWEEN THE PARTS SHALL BE REPORTED TO THE ARCHITECT PRIOR TO COMMENCEMENT OF WORK.

THESE DRAWINGS ARE PART OF THE CONTRACT DOCUMENTS FOR THIS PROJECT. THESE DRAWINGS ARE THE GRAPHIC ILLUSTRATION OF THE WORK TO BE ACCOMPLISHED.

ORGANIZATION:
 THE DRAWINGS FOLLOW A LOGICAL, INTERDISCIPLINARY FORMAT: ARCHITECTURAL DRAWINGS (A SHEETS), INTERIOR DRAWINGS (I SHEETS), STRUCTURAL DRAWINGS (S SHEETS), MECHANICAL AND PLUMBING DRAWINGS (M SHEETS), ELECTRICAL (E SHEETS), AND LIGHTING (LP SHEETS). THESE DRAWINGS ARE ORGANIZED BY BUILDING UNIT.

THOUGH THE ENTIRE PROJECT IS DEFINED AS A SINGLE STRUCTURE DUE TO THE CONNECTED PARTS, EACH BUILDING HAS ITS OWN CORRESPONDING SET OF ARCHITECTURAL AND ENGINEERING DOCUMENTS. THE GARAGE IS CONSIDERED ITS OWN ENTITY, AS ARE THE RENOVATIONS OF THE EXISTING LOBBY INTO SPA FACILITIES.

SYSTEMS AND DETAILS HAVE BEEN STANDARDIZED AS MUCH AS POSSIBLE THROUGHOUT EACH STRUCTURE FOR ECONOMY AND EASE OF UNDERSTANDING; SOME DETAILS ARE THEREFORE REPLICATED IN BUILDINGS FOR CONTRACTOR AND SUBCONTRACTOR CONVENIENCE.

CODE COMPLIANCE:
 ALL WORK, MATERIALS, AND ASSEMBLIES SHALL COMPLY WITH APPLICABLE STATE AND LOCAL CODES, ORDINANCES, AND REGULATIONS. THE CONTRACTOR, SUBCONTRACTORS AND JOURNEMEN OF THE APPROPRIATE TRADES SHALL PERFORM WORK TO THE HIGHEST STANDARDS OF CRAFTSMANSHIP.

INTENT:
 THESE DOCUMENTS ARE INTENDED TO INCLUDE ALL LABOR, MATERIALS, EQUIPMENT AND SERVICES REQUIRED TO COMPLETE THE WORK DESCRIBED HEREIN.

COORDINATION:
 THE CONTRACTOR SHALL CAREFULLY STUDY AND COMPARE THE DOCUMENTS, VERIFY THE ACTUAL CONDITIONS, AND REPORT ANY DISCREPANCIES, ERRORS, OR OMISSIONS TO THE ARCHITECT IN A TIMELY MANNER. THE ARCHITECT SHALL CLARIFY OR PROVIDE REASONABLE ADDITIONAL INFORMATION REQUIRED FOR SUCCESSFUL EXECUTION. THE CONTRACTOR SHALL VERIFY AND COORDINATE ALL OPENINGS THROUGH FLOORS, CEILINGS AND WALLS WITH ALL ARCHITECTURAL, INTERIOR, STRUCTURAL, MECHANICAL AND PLUMBING, ELECTRICAL, AND LIGHTING DRAWINGS.

SHEET INDEX

SHEET NUMBER	SHEET NAME
A0.0	COVER & PROJECT INFORMATION
A0.1	SITE PHOTOS
A0.2	PROJECT RENDERINGS TOPOGRAPHIC SITE SURVEY
CIVIL SERIES	
C1	CIVIL ENGINEERING GENERAL NOTES
C2	GRADING AND DRAINAGE WITH DRIVEWAY PROFILE
C3	UTILITIES
LANDSCAPE SERIES	
L1.0	LANDSCAPE ILLUSTRATIVE PLAN
L2.0	LANDSCAPE PLANTING PLAN
L3.0	WILDFIRE MITIGATION PLAN
L4.0	LANDSCAPE ILLUSTRATIVE IMAGERY
ARCHITECTURAL SERIES	
A1.0	SITE CONTEXT
A1.1	COMPILED SITE & LANDSCAPE PLAN
A1.2	BUILDING HEIGHT CALCS.
A1.3	SITE SECTIONS
A2.0	FLOOR AREA SUMMARY
A2.1	MOTOR COURT & ENTRY PLAN
A2.2	LOWER LEVEL PLAN
A2.3	MAIN LEVEL PLAN
A2.4	EAST ROOF PLAN
A2.5	UPPER LEVEL PLAN
A3.0	EXTERIOR MATERIALS
A3.1	COMPILED EAST & WEST ELEVATIONS
A3.2	COMPILED NORTH & SOUTH ELEVATIONS

PROJECT TEAM

OWNER:
 JENNIFER BIRDWELL

ARCHITECT:
 TOMMY HEIN ARCHITECTS
 108 S OAK ST | PO BOX 3327
 TELLURIDE CO, 81435
 P. 970.728.1220 | F. 970.728.6457
 TOMMY@TOMMYHEIN.COM

PROJECT PLANNER:
 ALPINE PLANNING, LLC
 CHRIS HAWKINS
 P.O. BOX 645
 RIDGWAY, CO 81432
 970.964.7927
 CHRIS@ALPINEPLANNINGLLC.COM

CONTRACTOR:
 Fortenberry Ricks, LLC
 PAUL RICKS
 52 Pilot Knob Ln.
 Telluride CO 81435
 970.728.4321
 PAUL@FORTENBERRY.COM

INTERIORS
 SAGE HOUSE DESIGN
 CHRISTY BROWN
 220 E COLORADO AVE. UNIT 103
 TELLURIDE, CO 81435
 817.909.3959
 CHRISTY@SAGEHOUSEDESIGNS.COM

LANDSCAPE:
 SUPERBLOOM
 STACY PASSMORE
 23 LINCOLN STREET, SUITE 200
 DENVER, CO 80203
 214.228.1517
 stacy@superbloom.la

CIVIL:
 UNCOMPAGRE ENGINEERING, LLC
 DAVID BALLODE, P.E.
 P.O. BOX 3945
 TELLURIDE, CO 81435
 970.729.0683
 DBALLODE@MSN.COM

STRUCTURAL:
 COLORADO STRUCTURAL
 MIKE ARBANEY
 315 BELLEVUE, SUITE 2B
 P.O. BOX 2544
 CRESTED BUTTE, CO 81224
 970.349.5922
 MIKE@COLORADOSTRUCTURAL.COM

MECHANICAL, ELECTRICAL, PLUMBING:
 HUGHES CONSULTING ENGINEERING
 DIMITRI MERRILL
 220W. COLORADO AVE.
 TELLURIDE, CO 81435
 970.239.1949
 DIMITRI@HCE-PA.COM

LIGHTING:
 TBD

SURVEYOR:
 JEFF HASKELL
 125 W PACIFIC, SUITE B-1
 TELLURIDE, CO 81501
 970.728.6153
 JHASKELL@FOLEYASSOC.COM

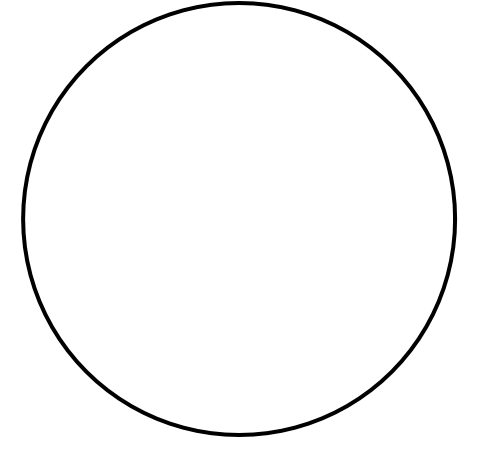

SUBMISSIONS

DATE:	SUBMISSION
09.22.2020	CLIENT MEETING
09.29.2020	CLIENT MEETING
10.16.2020	PLAN REVIEW
11.05.2020	DRB REVIEW
01.25.2021	CLIENT REVIEW
02.03.2021	DRB SKETCH REVIEW

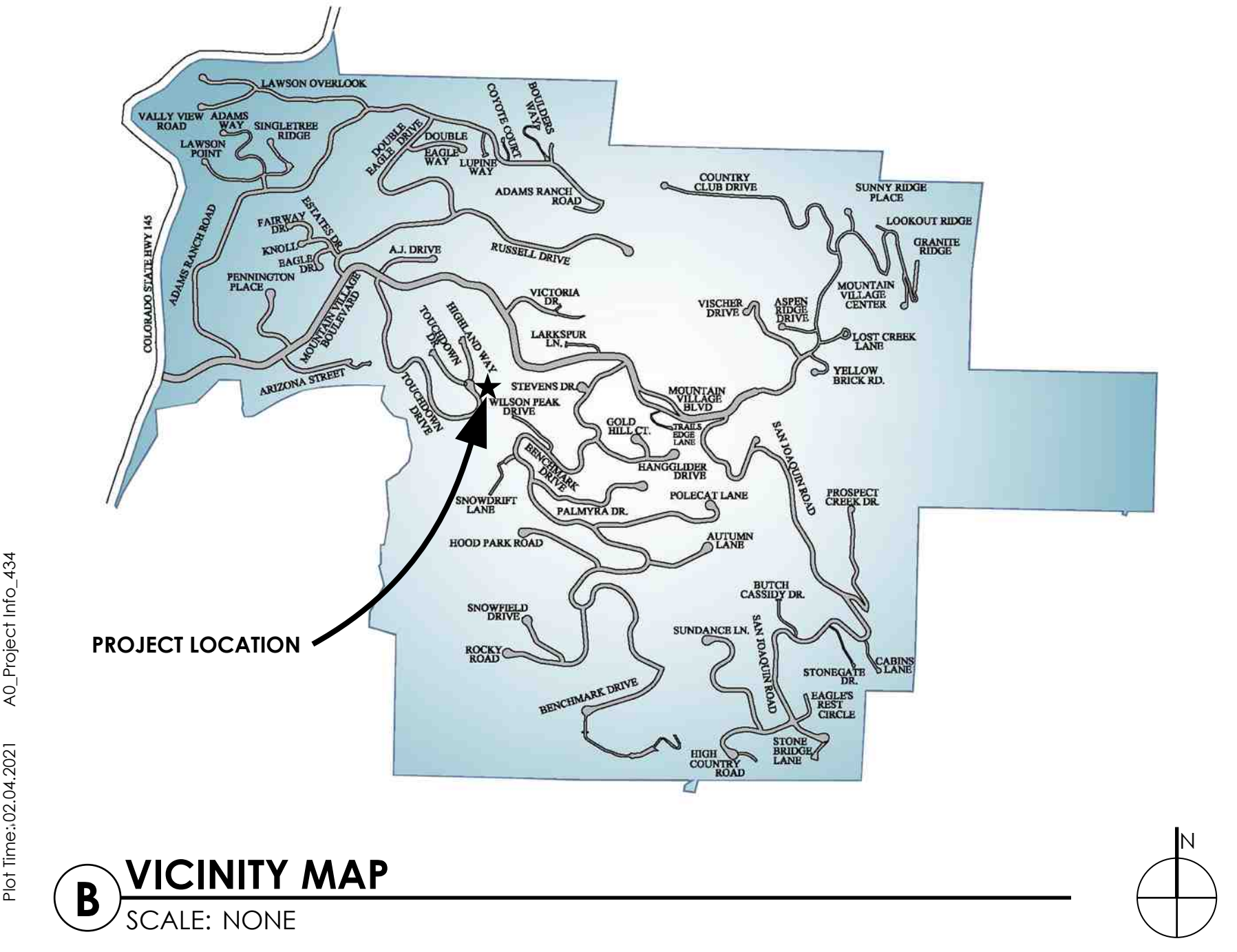

LOT 434
 TOUCHDOWN DR
 MTN. VILLAGE
 COLORADO

COVER /
 PROJECT
 INFO



Plot Title: 02.04.2021 A0_Project Info_434



1 SITE PANORAMA LOOKING WEST



2 SITE PHOTO LOOKING NORTH EAST



3 SITE PANORAMA NORTH TO EAST



4 VIEW TO SKI AREA

Tommy Hein
ARCHITECTS
Box 3327 Telluride, Colorado 970.728.1220 | 108 S. Oak St. Colorado 81435 | Penthouse 81435 www.TommyHein.com

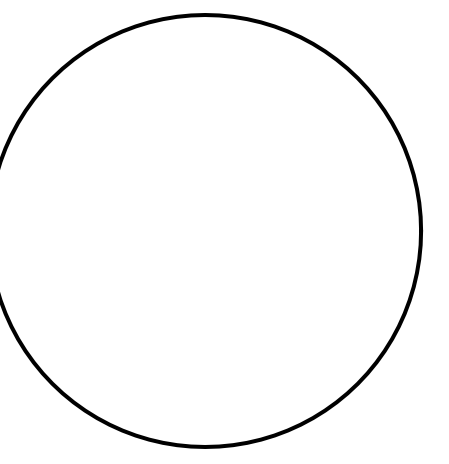

SUBMISSIONS

DATE	SUBMISSION
09.22.2020	CLIENT MEETING
09.29.2020	CLIENT MEETING
10.16.2020	PLAN REVIEW
11.05.2020	DRB REVIEW
01.25.2021	CLIENT REVIEW
02.03.2021	DRB SKETCH REVIEW

The Refuge

LOT 434
TOUCHDOWN DR
MTN. VILLAGE
COLORADO

SITE PHOTOS

A.1



1 NORTH WEST AERIAL VIEW



2 EAST VIEW



3 DRIVE ENTRY VIEW



4 NORTH WEST VIEW



5 SOUTH STREET VIEW



6 PATIO VIEW



7 ENTRY VIEW



8 EAST VIEW

Tommy Hein
ARCHITECTS

Box 3327 Telluride, CO 81435
108 S. Oak St. Penthouse Colorado 81435
970.728.1220 www.TommyHein.com

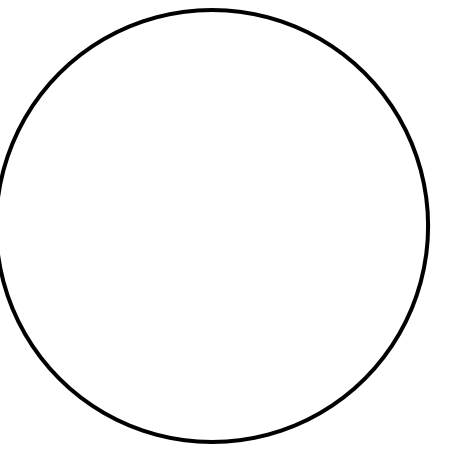

SUBMISSIONS

DATE:	SUBMISSION
09.22.2020	CLIENT MEETING
09.29.2020	CLIENT MEETING
10.16.2020	PLAN REVIEW
11.05.2020	DRB REVIEW
01.25.2021	CLIENT REVIEW
02.03.2021	DRB SKETCH REVIEW

The Refuge

LOT 434
TOUCHDOWN DR
MTN. VILLAGE
COLORADO

**PROJECT
RENDERINGS**

A.0.2

CIVIL ENGINEERING GENERAL NOTES:

1. THE EXISTING UTILITY LINES SHOWN ON THE PLANS ARE APPROXIMATE. AT LEAST TWO (2) FULL WORKING DAYS PRIOR TO COMMENCING CONSTRUCTION, THE CONTRACTOR SHALL CONTACT THE UTILITY NOTIFICATION CENTER OF COLORADO @ 1-800-922-1987 OR 811 TO GET ALL UTILITIES LOCATED. IF ANY OF THESE UNDERGROUND UTILITIES ARE IN CONFLICT WITH THE CONSTRUCTION PLANS, THE CONTRACTOR SHALL NOTIFY THE ENGINEER AND WORK WITH THE ENGINEER TO FIND A SOLUTION BEFORE THE START OF CONSTRUCTION.

INSTALLATION AND SEPARATION REQUIREMENTS SHALL BE COORDINATED WITH THE INDIVIDUAL UTILITY PROVIDERS.

THE UTILITY PROVIDERS ARE:
SEWER, WATER, CABLE TV AND FIBEROPTIC: TOWN OF MOUNTAIN VILLAGE
NATURAL GAS: BLACK HILLS ENERGY
POWER: SAN MIGUEL POWER
TELEPHONE: CENTURY LINK

2. PRIOR TO BEGINNING ANY CONSTRUCTION ACTIVITIES, ALL NECESSARY PERMITS SHALL BE OBTAINED BY THE OWNER OR CONTRACTOR.

3. IT IS THE CONTRACTOR'S RESPONSIBILITY TO INSURE THAT EXCAVATED SLOPES ARE SAFE AND COMPLY WITH OSHA REQUIREMENTS. REFER TO THE SITE-SPECIFIC REPORT FOR THIS PROJECT FOR ADDITIONAL INFORMATION..

4. ALL TRENCHES SHALL BE ADEQUATELY SUPPORTED OR LAID BACK PER OSHA REGULATIONS.

5. ALL MATERIALS AND CONSTRUCTION SHALL BE IN CONFORMANCE WITH THE TOWN OF MOUNTAIN VILLAGE DESIGN STANDARDS LATEST EDITION. ALL CONSTRUCTION WITHIN EXISTING STREET OR ALLEY RIGHT-OF-WAY SHALL BE SUBJECT TO TOWN OF MOUNTAIN VILLAGE INSPECTION.

6. THE CONTRACTOR SHALL HAVE ONE COPY OF THE STAMPED PLANS ON THE JOB SITE AT ALL TIMES.

7. THE CONTRACTOR SHALL NOTIFY THE TOWN 48 HOURS PRIOR TO THE START OF CONSTRUCTION.

8. THE CONTRACTOR IS RESPONSIBLE FOR IMPLEMENTING AND MAINTAINING EROSION AND SEDIMENT CONTROL MEASURES AT ALL TIMES DURING CONSTRUCTION. THE ADJOINING ROADWAYS SHALL BE FREE OF DEBRIS AT THE END OF CONSTRUCTION ACTIVITIES EACH DAY.

9. THE CONTRACTOR SHALL PROVIDE, ERECT AND MAINTAIN PROPER TRAFFIC CONTROL DEVICES UNTIL THE SITE IS OPEN TO TRAFFIC. ANY TRAFFIC CLOSURES MUST BE COORDINATED WITH THE TOWN OF MOUNTAIN VILLAGE.

10. ALL DAMAGE TO PUBLIC STREETS AND ROADS, INCLUDING HAUL ROUTES, TRAILS, OR STREET IMPROVEMENTS, OR TO PRIVATE PROPERTY, SHALL BE REPAIRED AT THE SOLE EXPENSE OF THE CONTRACTOR TO THE ORIGINAL CONDITIONS.

11. WHEN AN EXISTING ASPHALT STREET IS CUT, THE STREET MUST BE RESTORED TO A CONDITION EQUAL TO OR BETTER THAN ITS ORIGINAL CONDITION. THE FINISHED PATCH SHALL BLEND SMOOTHLY INTO THE EXISTING SURFACE. ALL LARGE PATCHES SHALL BE PAVED WITH AN ASPHALT LAY-DOWN MACHINE.

12. IF DEWATERING IS REQUIRED, THE CONTRACTOR SHALL NOTIFY THE ENGINEER. ANY DISCHARGE REQUIREMENTS SHALL BE COORDINATED WITH THE TOWN OF MOUNTAIN VILLAGE.

13. CONTRACTOR SHALL NOTIFY ALL RESIDENTS IN WRITING 24 HOURS PRIOR TO ANY SHUT-OFF IN SERVICE. THE NOTICES MUST HAVE CONTRACTOR'S PHONE NUMBER AND NAME OF CONTACT PERSON, AND EMERGENCY PHONE NUMBER FOR AFTER HOURS CALLS. ALL SHUT-OFF'S MUST BE APPROVED BY THE TOWN AND TOWN VALVES AND APPURTENANCES SHALL BE OPERATED BY TOWN PERSONNEL.

14. CONTRACTOR SHALL KEEP SITE CLEAN AND LITTER FREE (INCLUDING CIGARETTE BUTTS) BY PROVIDING A CONSTRUCTION DEBRIS TRASH CONTAINER AND A BEAR-PROOF POLY-CART TRASH CONTAINER, WHICH IS TO BE LOCKED AT ALL TIMES.

15. CONTRACTOR MUST BE AWARE OF ALL TREES TO REMAIN PER THE DESIGN AND APPROVAL PROCESS AND PROTECT THEM ACCORDINGLY.

16. THE CONTRACTOR SHALL PROVIDE UNDERGROUND UTILITY AS-BUILTS TO THE TOWN.

17. ALL STRUCTURAL FILL UNDER HARDSCAPE OR ROADS MUST BE COMPACTED TO 95% MODIFIED PROCTOR (MIN.) AT PLUS OR MINUS 2% OF THE OPTIMUM MOISTURE CONTENT. NON-STRUCTURAL FILL SHALL BE PLACED AT 90% (MIN.) MODIFIED PROCTOR.

18. UNSUITABLE MATERIAL SHALL BE REMOVED AS REQUIRED BY THE SOILS ENGINEER. ALL MATERIALS SUCH AS LUMBER, LOGS, BRUSH, TOPSOIL OR ORGANIC MATERIALS OR RUBBISH SHALL BE REMOVED FROM ALL AREAS TO RECEIVE COMPACTED FILL.

19. NO MATERIAL SHALL BE COMPACTED WHEN FROZEN.

20. NATIVE TOPSOIL SHALL BE STOCKPILED TO THE EXTENT FEASIBLE ON THE SITE FOR USE ON AREAS TO BE REVEGETATED.

21. THE CONTRACTOR SHALL BE RESPONSIBLE FOR DUST ABATEMENT AND EROSION CONTROL MEASURES DEEMED NECESSARY BY THE TOWN, IF CONDITIONS WARRANT THEM.

22. ALL DISTURBED GROUND SHALL BE RE-SEEDED WITH A TOWN-APPROVED SEED MIX. REFER TO THE LANDSCAPE PLAN.

23. THE CONTRACTOR IS REQUIRED TO PROTECT ALL EXISTING SURVEY MONUMENTS AND PROPERTY CORNERS DURING GRADING AND CONSTRUCTION.

24. ALL UNDERGROUND PIPE SHALL BE PROTECTED WITH BEDDING TO PROTECT THE PIPE FROM BEING DAMAGED.

25. HOT TUBS SHALL DRAIN TO THE SANITARY SEWER (OR PUMPED TO AA CLEAN-OUT).

26. THE UTILITY PLAN DEPICTS FINAL UTILITY LOCATIONS BUT HAS BEEN COMPLETED AT A PRELIMINARY STAGE. CONTRACTOR SHALL VERIFY ALIGNMENTS WITH THE ARCHITECT PRIOR TO CONSTRUCTION.

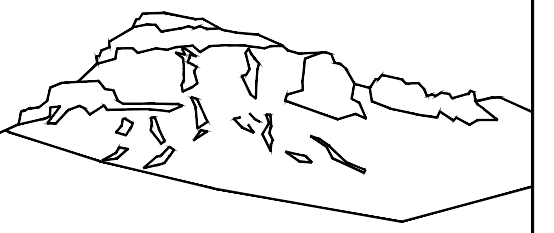

Uncompahgre
Engineering, LLC

P.O. Box 3945
Telluride, CO 81435
970-729-0683

SUBMISSIONS:

DRB 2021-02-02

The Bridwell Residence
Lot 434
Touchdown Drive
Mtn. Village, CO



CONTRACTOR TO REVIEW AND COMPARE ALL CHAPTERS AND INTERDISCIPLINARY DRAWINGS AND REPORT ANY DISCREPANCIES TO THE ARCHITECT PRIOR TO ANY FIELD WORK BEING DONE IN ACCORDANCE WITH AIA DOCUMENT A201

Civil
Engineering

General Notes

C1

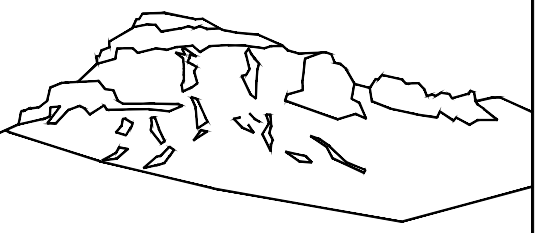

Uncompahgre Engineering, LLC

P.O. Box 3945
Telluride, CO 81435
970-729-0683

SUBMISSIONS:
DRB 2021-02-02

The Bridwell Residence
Lot 434
Touchdown Drive
Mtn. Village, CO



CONTRACTOR TO REVIEW AND COMPARE ALL CHAPTERS AND INTERDISCIPLINARY DRAWINGS AND REPORT ANY DISCREPANCIES TO THE ARCHITECT PRIOR TO ANY FIELD WORK BEING DONE IN ACCORDANCE WITH AIA DOCUMENT A201

Grading and Drainage
with Driveway Profile

C2

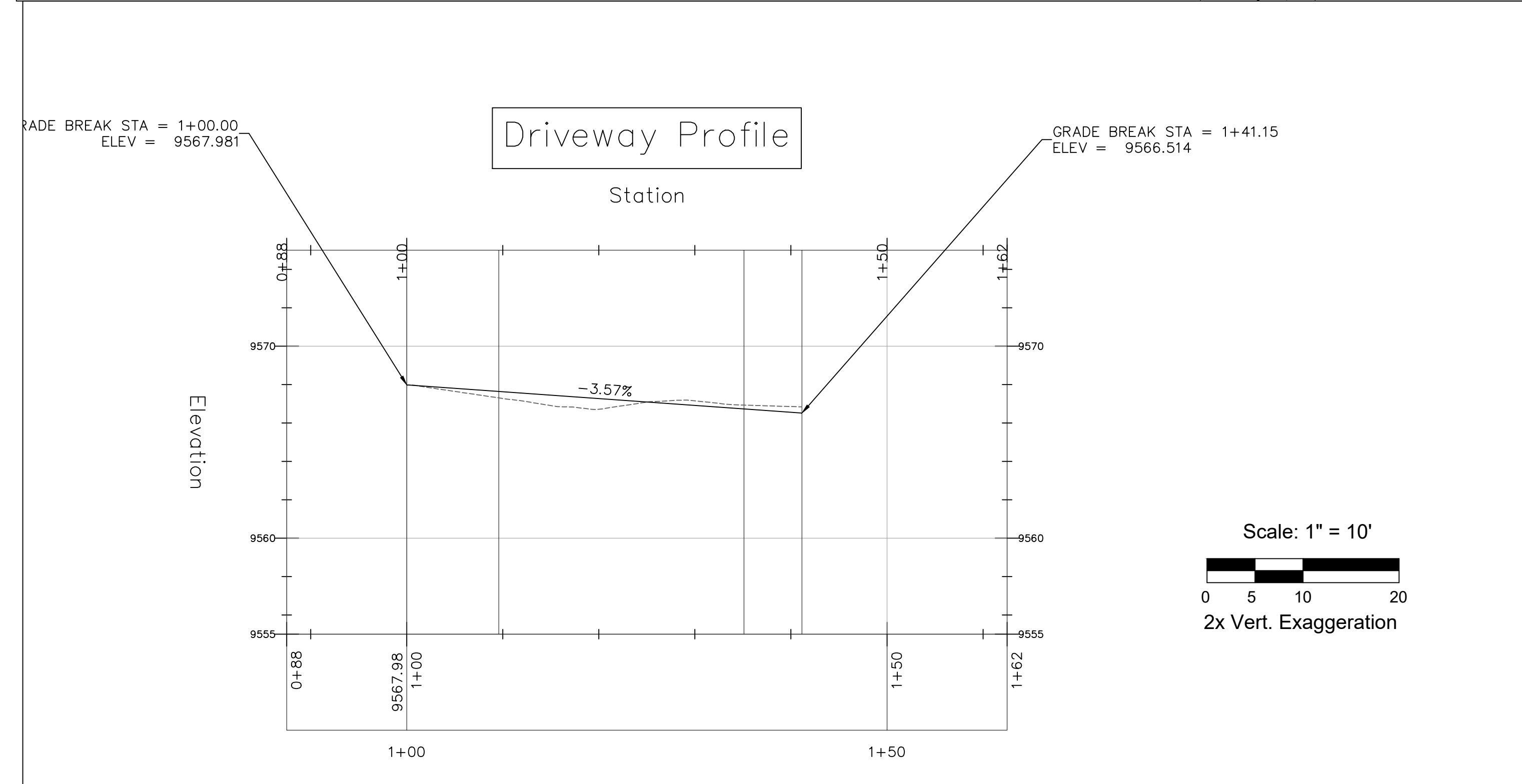
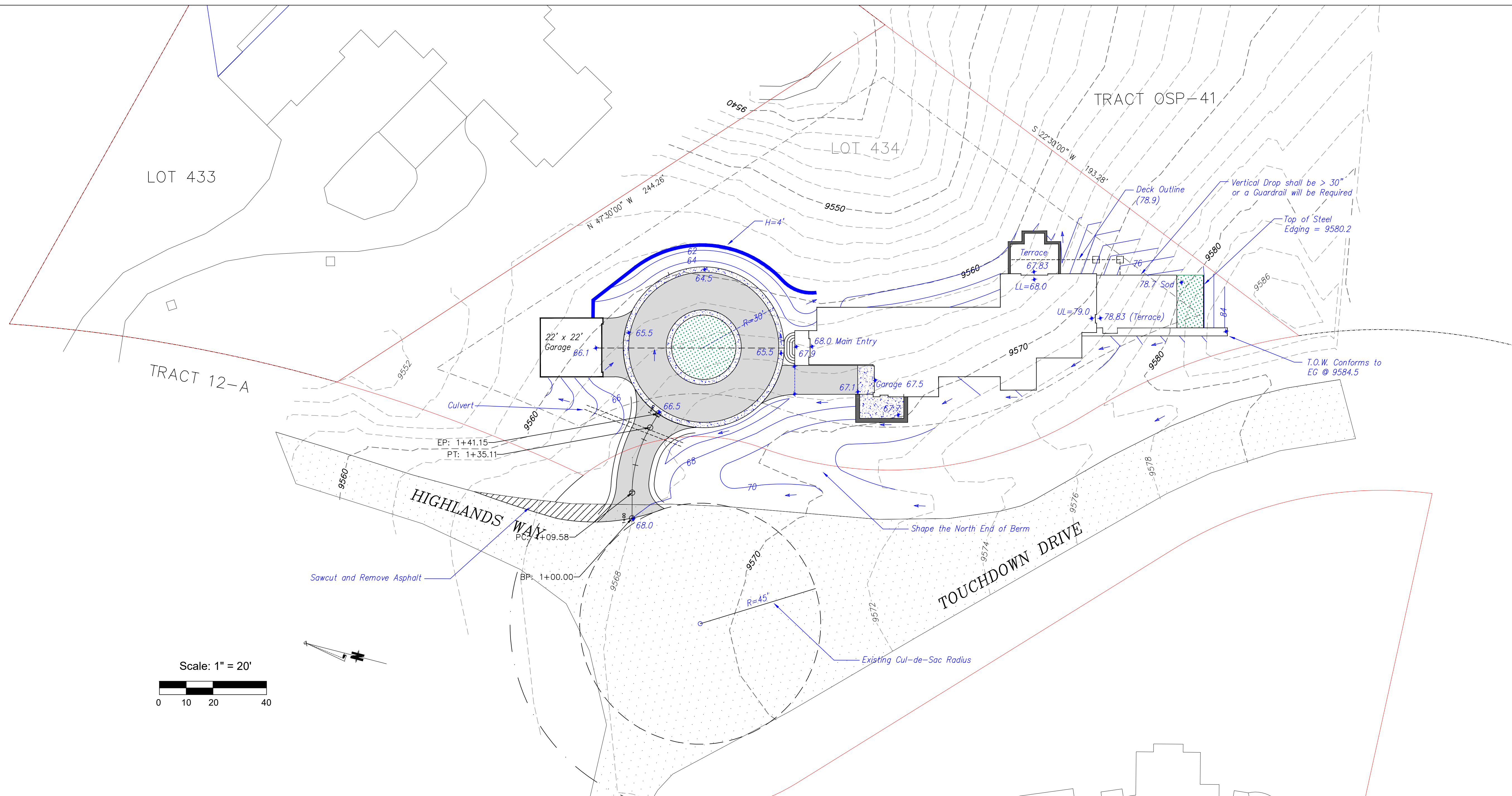

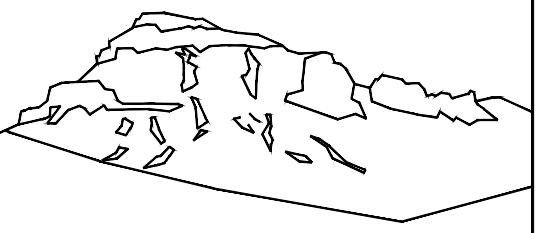

Uncompahgre
Engineering, LLC

P.O. Box 3945
Telluride, CO 81435
970-729-0683

SUBMISSIONS:
DRB 2021-02-02

The Bridwell Residence
Lot 434
Touchdown Drive
Mtn. Village, CO



CONTRACTOR TO REVIEW AND COMPARE ALL
CHAPTERS AND INTERDISCIPLINARY DRAWINGS
AND REPORT ANY DISCREPANCIES TO THE
ARCHITECT PRIOR TO ANY FIELD WORK BEING
DONE IN ACCORDANCE WITH AIA DOCUMENT A201

Utilities

C3

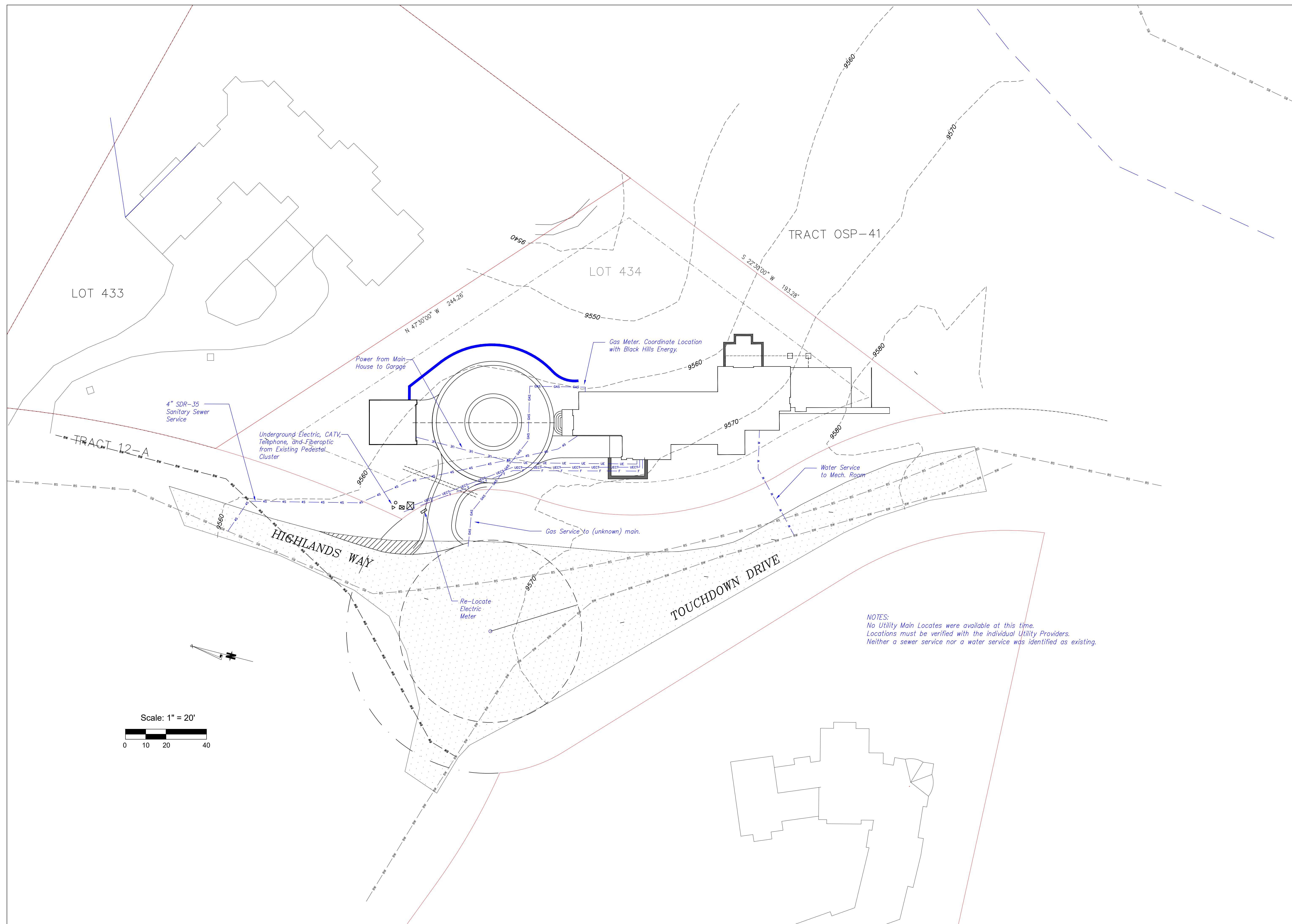

NOTES:
No Utility Main Locates were available at this time.
Locations must be verified with the individual Utility Providers.
Neither a sewer service nor a water service was identified as existing.

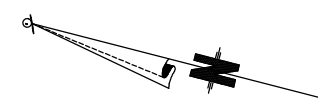
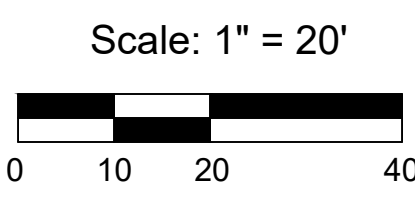

ILLUSTRATIVE LANDSCAPE PLAN

LOT 434 / TOUCHDOWN DRIVE | MOUNTAIN VILLAGE, CO

LANDSCAPE SHEET INDEX

- L1.0 ILLUSTRATIVE LANDSCAPE PLAN
- L2.0 LANDSCAPE PLANTING PLAN
- L3.0 WILDFIRE MITIGATION PLAN
- L4.0 LANDSCAPE IMAGERY

LANDSCAPE NARRATIVE

Formalized Nature/Naturalized Rarities:
 The landscape concept draws inspiration from the site's position overlapping between a thick aspen forest and the open meadows of the ski area open space. The design introduces new aspen plantings, but in an orderly design to complement but contrast the existing aspens. The central island in the driveway and radial plantings include rain gardens with plants that will enjoy the summer monsoons and spring snow. A striking water fountain also lives in the island, welcoming visitors to the property and framing views of the mountain beyond. Clean, modern lines of native grasses and shrubs meet embedded, naturalized placement of unique specimen selected for color, texture and seasonality.

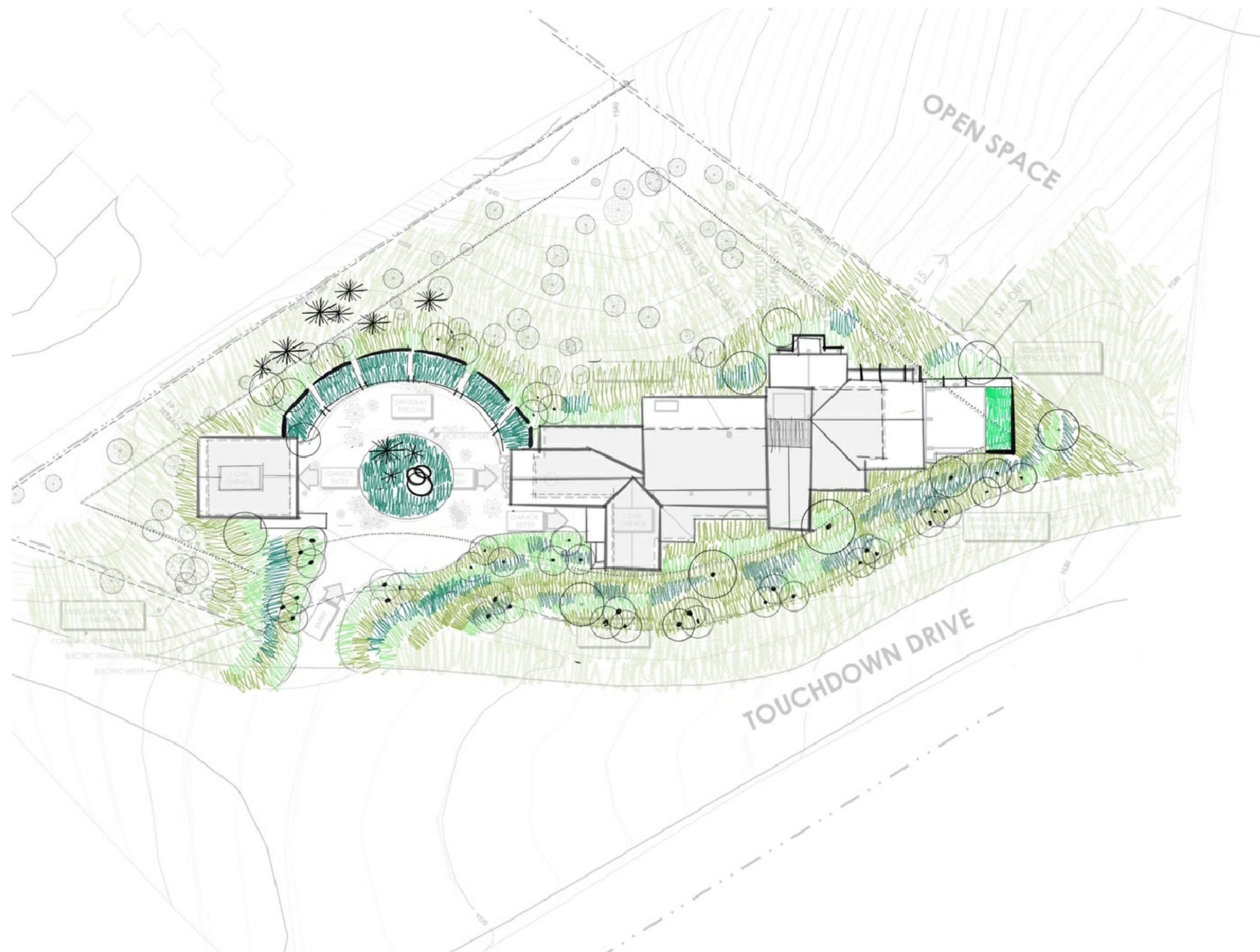

SUPERBLOOM

23 Lincoln Street, Suite 200
Denver, Colorado 80203
214.288.1517

Submissions

DRB SKETCH 2021.02.02

**NOT FOR
CONSTRUCTION**

**THE
REFUGE**

LOT 434
TOUCHDOWN DR.
MOUNTAIN VILLAGE,
CO | 81435

**LANDSCAPE
ILLUSTRATIVE
PLAN**

CONTRACTOR TO REVIEW AND COMPARE ALL CHAPTERS AND INTERDISCIPLINARY DRAWINGS AND REPORT ANY DISCREPANCIES TO THE ARCHITECT PRIOR TO ANY FIELD WORK BEING DONE IN ACCORDANCE WITH AIA DOCUMENT A201

L1.0

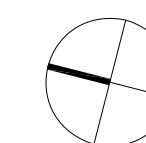

SCALE 0 1 2 3 4 1" = 20'-0"

L1.0 Landscape Site Plan-434MV.dwg

PLANTING SCHEDULE

SYMBOL	KEY	COMMON NAME	BOTANICAL NAME	SIZE	SPACING	TYPE	#
DECIDUOUS TREES (Minimum 2.5" dbh for Multi-Stem, 3" dbh for Single-Stem)							
POA		Narrowleaf Cottonwood	<i>Populus angustifolia</i>	3" dbh	as shown	B & B	5
POT		Quaking Aspen (single-stem) Exiting Tree to Remain	<i>Populus Tremuloides</i>	3" dbh	as shown	B & B	24

EVERGREEN TREES (Minimum 10-15' in height, with 30% 15' or larger)							
PIF		Limber Pine	<i>Pinus Flexilis</i>	10'-20' height	as shown	B & B	7
PIA		Skylands Spruce	<i>Picea orientalis 'Skylands'</i>	10'-20' height	as shown	B & B	3

SHRUBS							
SYMBOL	KEY	COMMON NAME	BOTANICAL NAME	SIZE	SPACING	TYPE	#
RIC		Wax Currant	<i>Ribes cereum</i>	5 gal.	as shown		41

ORNAMENTAL GRASSES & PERENNIALS							
SYMBOL	KEY	COMMON NAME	BOTANICAL NAME	SIZE	SPACING	TYPE	#
AST		Aster	Aster spp.	1 gal	as shown		
BOG		Blonde Ambition Blue Grama	<i>Bouteloa gracilis 'Blonde Ambition'</i>	1 gal	as shown		
LUP		Lupine	Lupinus spp.	1 gal	as shown		
VER		Speedwell	Veronica spp.	1 gal	as shown		

SEEDED GRASSES, PERENNIALS + SODDED TURF							
SYMBOL	KEY	COMMON NAME	BOTANICAL NAME	SIZE	SEED RATE	TYPE	#
MIX A		PLANTED GARDEN MIX	-	1 gal	n/a		
		Calamagrostis canadensis 15%					
		Delphinium spp. mix 20%					
		Deschmipsla cespitosa 40%					
		Iris spp. mix 20%					
		Pulsatilla vulgaris 10%					
MIX B		NATIVE GRASS SEED MIX (Per Mountain Village CDC p. 143)	-	seed	re: specs (typ.)		
		Western Yarrow 5%	Alpine Bluegrass 15%				
		Tall Fescue 10%	Canada Bluegrass 10%				
		Arizona Fescue 5%	Perennial Ryegrass 15%				
		Hard Fescue 5%	Slender Wheatgrass 10%				
		Creeping Red Fescue 10%	Mountain Brome 15%				
SOD		FESCUE TURF MIX	FESTUCA RUBRA (OR EQUIVALENT)	sod	see specs		

- IRRIGATION SYSTEM NOTES**
- ALL TREES AND SHRUBS TO BE DRIP IRRIGATED
 - A BACKFLOW PREVENTER BY A COLORADO LICENSED PLUMBER SHALL BE INSTALLED AFTER RECEIVING A PLUMBING PERMIT FROM THE TOWN.
 - INTERIOR AND EXTERIOR DRAIN VALVES AND AN INTERIOR DRAIN SHALL BE PROVIDED.
 - HEAD-TO-HEAD OR DOUBLE COVERAGE SHALL BE PROVIDED.
 - A MASTER CONTROL VALVE SHALL BE PROVIDED.
 - A FLOW CONTROL DEVICE TO PREVENT WATER LOSS IN THE EVENT OF A BREAK IN THE IRRIGATION SYSTEM SHALL BE PROVIDED.
 - SELF-SEALING HEADS SHALL BE PROVIDED TO REDUCE RUN OUT AFTER ZONE SHUT DOWN.
 - LOW-ANGLE SPRAY HEADS TO REDUCE WIND EFFECT AND MISTING ON AREAS OF TURF AND LOW-GROWING VEGETATION SHALL BE PROVIDED.
 - BUILDING CONTRACTOR WILL PROVIDE A MINIMUM 1" HARD COPPERLINE TO THE EXTERIOR OF THE RESIDENCE. COPPER STUB OUT WILL BE SET AT 12" BELOW FINISH GRADE AND TERMINATE WITH A 1" FEMALE ADAPTOR. ALL MECHANICAL COMPONENTS TO BE INSTALLED BY A LICENSED PLUMBER AND MEET ALL CURRENT CODES AND REGS.
 - GENERAL CONTRACTOR TO PROVIDE AND INSTALL ADEQUATE SLEEVING UNDER ALL PAVED SURFACES NOTED ON THE PLAN. SCHEDULE 80 PVC IS REQUIRED AND SHOULD HAVE A DIAMETER OF 4".
 - GENERAL CONTRACTOR TO PROVIDE 110 POWER TO THE EXTERIOR OF THE RESIDENCE AT A POINT NOT MORE THAN 10' AWAY FROM WATER SOURCE STUB OUT. CONTROLLER TO BE PROVIDED, INSTALLED, AND WIRED BY IRRIGATION CONTRACTOR.
 - GENERAL CONTRACTOR TO ENSURE A FLOW RATE OF 24 GPM MINIMUM 55 PSI FROM THE PROVIDED SOURCE. 100% HEAD TO HEAD COVERAGE REQUIRED ON ALL POP UP AND ROTOR NOZZLES.
 - MAINLINE ISOLATION VALVE TO BE INSTALLED IN MECHANICAL ROOM BEFORE BACKFLOW RP VALVE.
 - HALF INCH LATERAL POLY LINE WITH TWO 2-GALLON EMITTERS OR SIMILAR FOR EACH SHRUB AND ONE RING IN-LINE EMITTER 1/4" TUBING FOR TREES.
 - HUNTER PRESSURE COMPENSATION SYSTEM WITH BUILT-IN CHECK VALVE TO PREVENT EMITTER CLOGGING AND WATER LOSS. AS WELL AS TO ENSURE EVEN FLOWS ON ALL TERRAINS AND LATERAL LENGTHS. IS RECOMMENDED.
 - VACUUM/AIR RELEASE BALL VALVE TO BE INSTALLED IF SYSTEM IS RUNNING LENGTHS OVER SIGNIFICANT ELEVATION CHANGES TO PREVENT PIPE COLLAPSE.
 - ALL ZONES TO RUN AT < 80% OF SYSTEM CAPACITY.
 - ALL ROTOR ZONES TO BE ABANDONED UPON ESTABLISHMENT OF REVEG AREAS OR AFTER THE THIRD GROWING SEASON.
 - WIFI READY CONTROLLER TO BE PAIRED WITH RAIN SENSOR; SENSOR TO BE LOCATED IN AN OPEN AREA.

IRRIGATION USE CHART

ASPEN TREES	@ 10 GAL/MO
SPRUCE/PINE	@ 10 GAL/MO
SHRUBS	@ 2 GAL/MO
SOD	@ 3 GAL/MO
PERENNIAL BEDS	@ 2.5 GAL/MO
NATIVE SEED/REVEG	@ 2 GAL/MO

(APPROXIMATE MONTHLY USAGE)

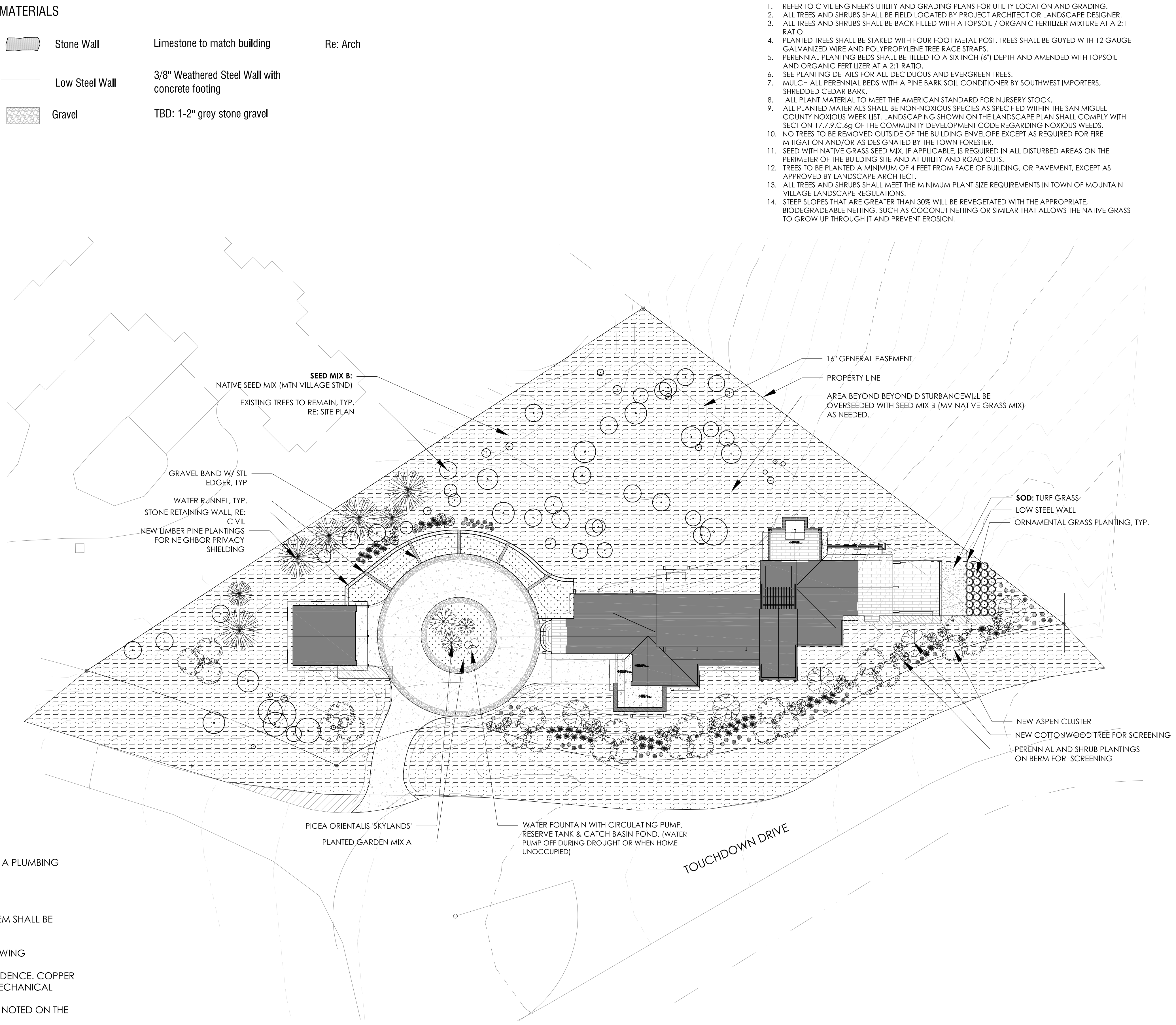

- LANDSCAPE GENERAL NOTES:**
- REFER TO CIVIL ENGINEER'S UTILITY AND GRADING PLANS FOR UTILITY LOCATION AND GRADING.
 - ALL TREES AND SHRUBS SHALL BE FIELD LOCATED BY PROJECT ARCHITECT OR LANDSCAPE DESIGNER.
 - ALL TREES AND SHRUBS SHALL BE BACK FILLED WITH A TOPSOIL / ORGANIC FERTILIZER MIXTURE AT A 2:1 RATIO.
 - PLANTED TREES SHALL BE STAKED WITH FOUR FOOT METAL POST. TREES SHALL BE GUYED WITH 12 GAUGE GALVANIZED WIRE AND POLYPROPYLENE TREE RACE STRAPS.
 - PERENNIAL PLANTING BEDS SHALL BE TILLED TO A SIX INCH (6") DEPTH AND AMENDED WITH TOPSOIL AND ORGANIC FERTILIZER AT A 2:1 RATIO.
 - SEE PLANTING DETAILS FOR ALL DECIDUOUS AND EVERGREEN TREES.
 - MULCH ALL PERENNIAL BEDS WITH A PINE BARK SOIL CONDITIONER BY SOUTHWEST IMPORTERS, SHREDDED CEDAR BARK.
 - ALL PLANT MATERIAL TO MEET THE AMERICAN STANDARD FOR NURSERY STOCK.
 - ALL PLANTED MATERIALS SHALL BE NON-NOXIOUS SPECIES AS SPECIFIED WITHIN THE SAN MIGUEL COUNTY NOXIOUS WEED LIST. LANDSCAPING SHOWN ON THE LANDSCAPE PLAN SHALL COMPLY WITH SECTION 17.7.9.C.6g OF THE COMMUNITY DEVELOPMENT CODE REGARDING NOXIOUS WEEDS.
 - NO TREES TO BE REMOVED OUTSIDE OF THE BUILDING ENVELOPE EXCEPT AS REQUIRED FOR FIRE MITIGATION AND/OR AS DESIGNATED BY THE TOWN FORESTER.
 - SEED WITH NATIVE GRASS SEED MIX. IF APPLICABLE. IS REQUIRED IN ALL DISTURBED AREAS ON THE PERIMETER OF THE BUILDING SITE AND AT UTILITY AND ROAD CUTS.
 - TREES TO BE PLANTED A MINIMUM OF 4 FEET FROM FACE OF BUILDING, OR PAVEMENT, EXCEPT AS APPROVED BY LANDSCAPE ARCHITECT.
 - ALL TREES AND SHRUBS SHALL MEET THE MINIMUM PLANT SIZE REQUIREMENTS IN TOWN OF MOUNTAIN VILLAGE LANDSCAPE REGULATIONS.
 - STEEP SLOPES THAT ARE GREATER THAN 30% WILL BE REVEGETATED WITH THE APPROPRIATE, BIODEGRADABLE NETTING, SUCH AS COCONUT NETTING OR SIMILAR THAT ALLOWS THE NATIVE GRASS TO GROW UP THROUGH IT AND PREVENT EROSION.

SUPERBLOOM

23 Lincoln Street, Suite 200
Denver, Colorado 80203
214.288.1517

Submissions

DRB SKETCH 2021.02.02

NOT FOR CONSTRUCTION

THE REFUGE

LOT 434
TOUCHDOWN DR.
MOUNTAIN VILLAGE,
CO | 81435

LANDSCAPE PLANTING PLAN



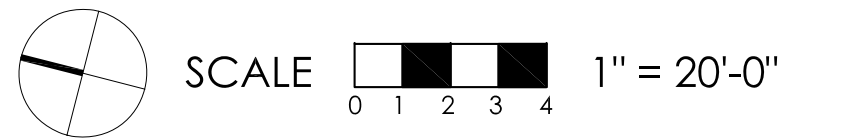

CONTRACTOR TO REVIEW AND COMPARE ALL CHAPTERS AND INTERDISCIPLINARY DRAWINGS AND REPORT ANY DISCREPANCIES TO THE ARCHITECT PRIOR TO ANY FIELD WORK BEING DONE IN ACCORDANCE WITH AIA DOCUMENT A201

L2.0



L1.0 Landscape Site Plan - 434MV.dwg

LEGEND

-  WILDFIRE MITIGATION ZONE 1
-  WILDFIRE MITIGATION ZONE 2
-  EXISTING TREE TO REMAIN
-  EXISTING TREE TO BE REMOVED

WILDFIRE MITIGATION NOTES

ZONE 1 (15' OFFSET FROM BUILDING DRIPLINE) - ALL EXISTING TREES GREATER THAN 4' CALIPER WILL BE REMOVED. TREES THAT ARE LOCATED OFF PROPERTY IN ZONE 1 WILL NOT BE REMOVED. ALL PROPOSED PLANTINGS IN ZONE 1 WILL BE SHURBS, GRASSES AND PERENNIALS SELECTED FROM A FIREWISE PLANT MATERIAL LIST AND WILL BE IRRIGATED. ALL PROPOSED PLANTINGS WILL NOT BE PLANTED DIRECTLY BENEATH WINDOWS OR NEXT TO FOUNDATION VENTS.

ZONE 2 - (THE REMAINING PORTION OF THE PROPERTY IS CONSIDERED ZONE 2) - ALL LADDER FUELS AND SLASH SHALL BE REMOVED FROM THE TEN FOOT (10') CROWN-TO-CROWN SEPARATION AREA. ALL STRESSED, DISEASED AND DYING TREES AND SHURBS AS IDENTIFIED BY STAFF, SHALL BE REMOVED. ALL CONIFEROUS TREES WILL BE ASSESSED AND CONFORM TO THE 10' CROWN TO CROWN SEPARATION AREA. TREES WILL BE ASSESSED AT THE TIME OF SITE PREPARATION FOR SPACING, HEALTH AND WIND THROW OR SNOW BREAKAGE POTENTIAL. REMAINING TREES IN ZONE 2 WILL HAVE BRANCHES PRUNED TO A HEIGHT OF 10' FROM THE GROUND BUT WILL NOT BE PRUNED TO MORE THAN $\frac{1}{3}$ OF THE TREE HEIGHT WITH THE FOLLOWING EXCEPTIONS:
 I.) ASPEN TREES, AND
 II.) ISOLATED SPRUCE AND FIR TREES

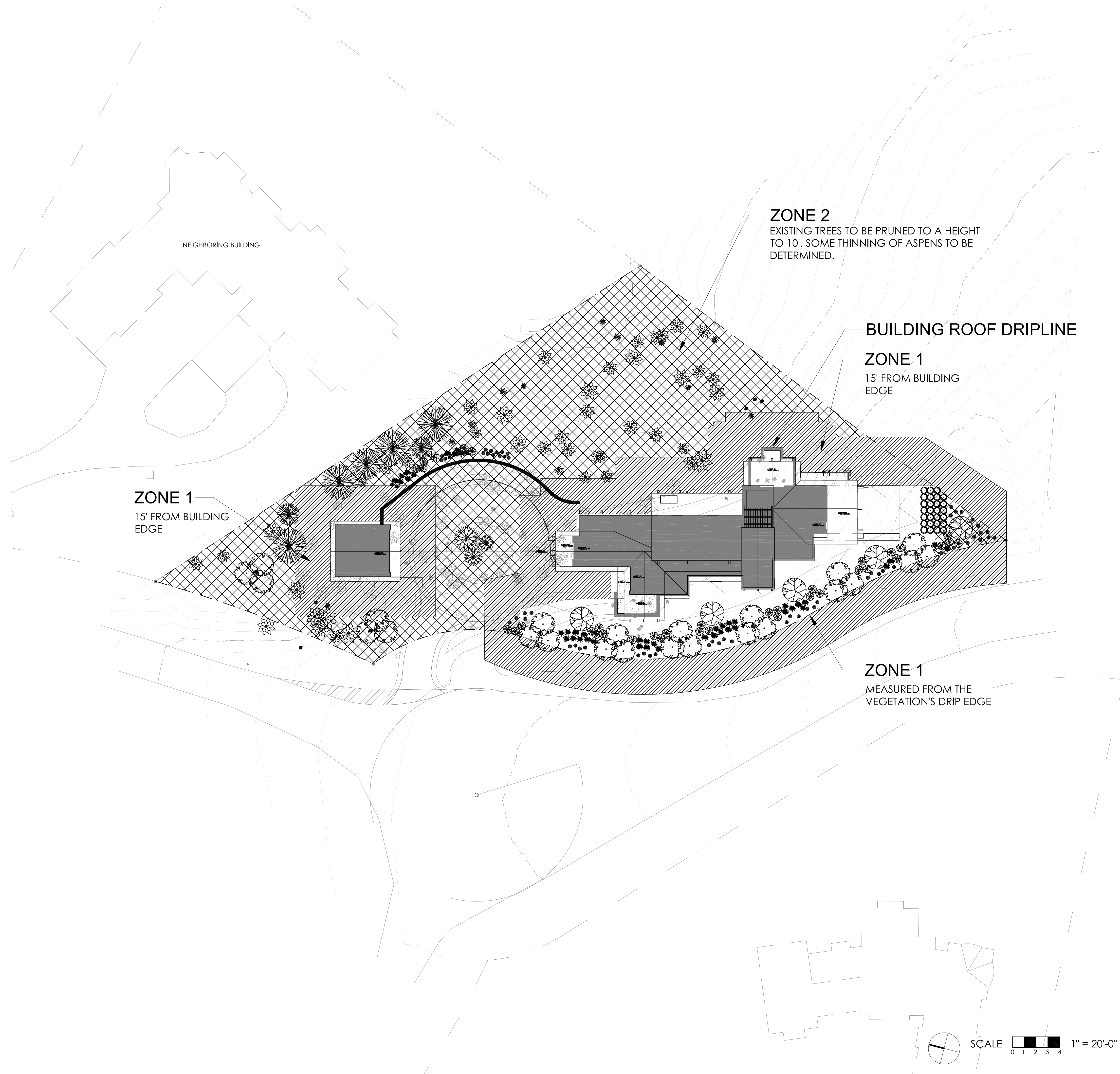

SUPERBLOOM

23 Lincoln Street, Suite 200
 Denver, Colorado 80203
 214.288.1517

Submissions

DRB SKETCH 2021.02.02

NOT FOR CONSTRUCTION

THE REFUGE

LOT 434
 TOUCHDOWN DR.
 MOUNTAIN VILLAGE,
 CO | 81435

WILDFIRE MITIGATION PLAN

CONTRACTOR TO REVIEW AND COMPARE ALL CHAPTERS AND INTERDISCIPLINARY DRAWINGS AND REPORT ANY DISCREPANCIES TO THE ARCHITECT PRIOR TO ANY FIELD WORK BEING DONE IN ACCORDANCE WITH AIA DOCUMENT A201

L3.0

L1.0 Landscape Site Plan-434MV.dwg

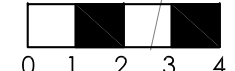
SCALE  1" = 20'-0"

PLANTING PRECEDENT IMAGES



STONE WALL EXAMPLE

Smooth cut with rough top stone boulder wall



RUNNEL EXAMPLE

Smooth cut with rough top stone boulder wall

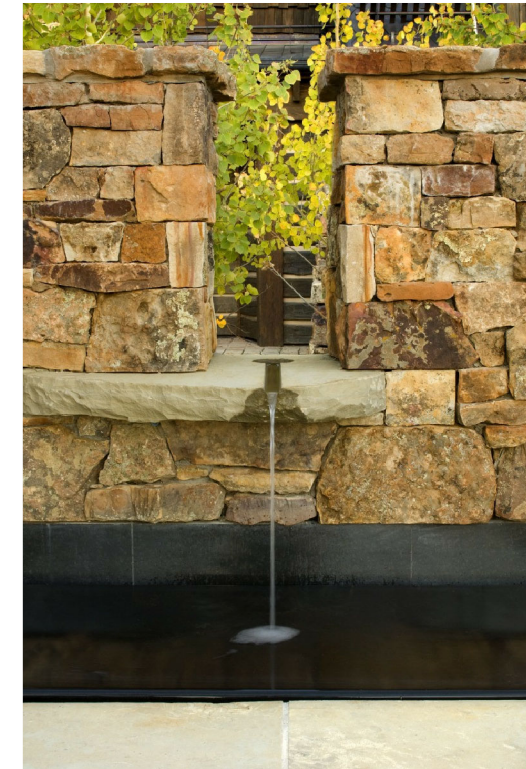

SUPERBLOOM

23 Lincoln Street, Suite 200
Denver, Colorado 80203
214.288.1517

Submissions

DRB SKETCH

2021.02.02

NOT FOR
CONSTRUCTION

THE
REFUGE

LOT 434
TOUCHDOWN DR.
MOUNTAIN VILLAGE,
CO | 81435

LANDSCAPE
ILLUSTRATIVE
IMAGERY

CONTRACTOR TO REVIEW AND COMPARE ALL CHAPTERS AND
INTERDISCIPLINARY DRAWINGS AND REPORT ANY
DISCREPANCIES TO THE ARCHITECT PRIOR TO ANY FIELD WORK
BEING DONE IN ACCORDANCE WITH AIA DOCUMENT A201

L4.0

L1.0 Landscape Site Plan-434MV.dwg

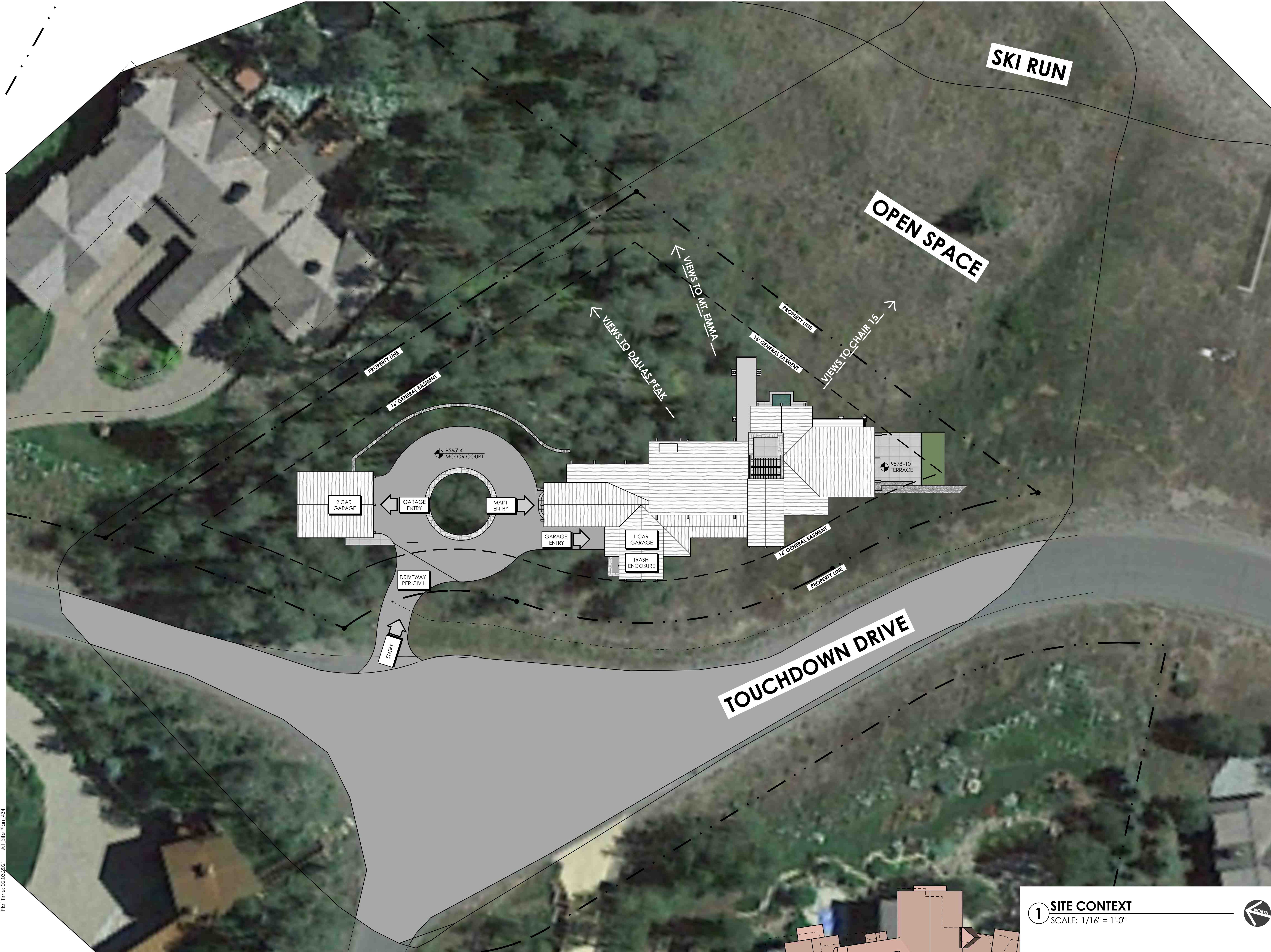

Plot Title: 02.03.2021 - A1 Site Plan_434

Tommy Hein
 ARCHITECTS
 Box 3327 Telluride, Colorado 970.728.1220 | 108 S. Oak St. Penthouse Colorado 81435 | www.TommyHein.com

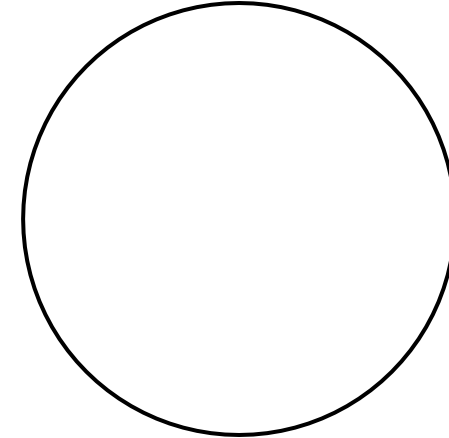

SUBMISSIONS

DATE:	SUBMISSION
09.22.2020	CLIENT MEETING
09.29.2020	CLIENT MEETING
10.16.2020	PLAN REVIEW
11.05.2020	DRB REVIEW
01.25.2021	CLIENT REVIEW
02.03.2021	DRB SKETCH REVIEW

The Refuge

LOT 434
 TOUCHDOWN DR
 MTN. VILLAGE
 COLORADO

SITE CONTEXT

A.1.0

1 SITE CONTEXT
 SCALE: 1/16" = 1'-0"



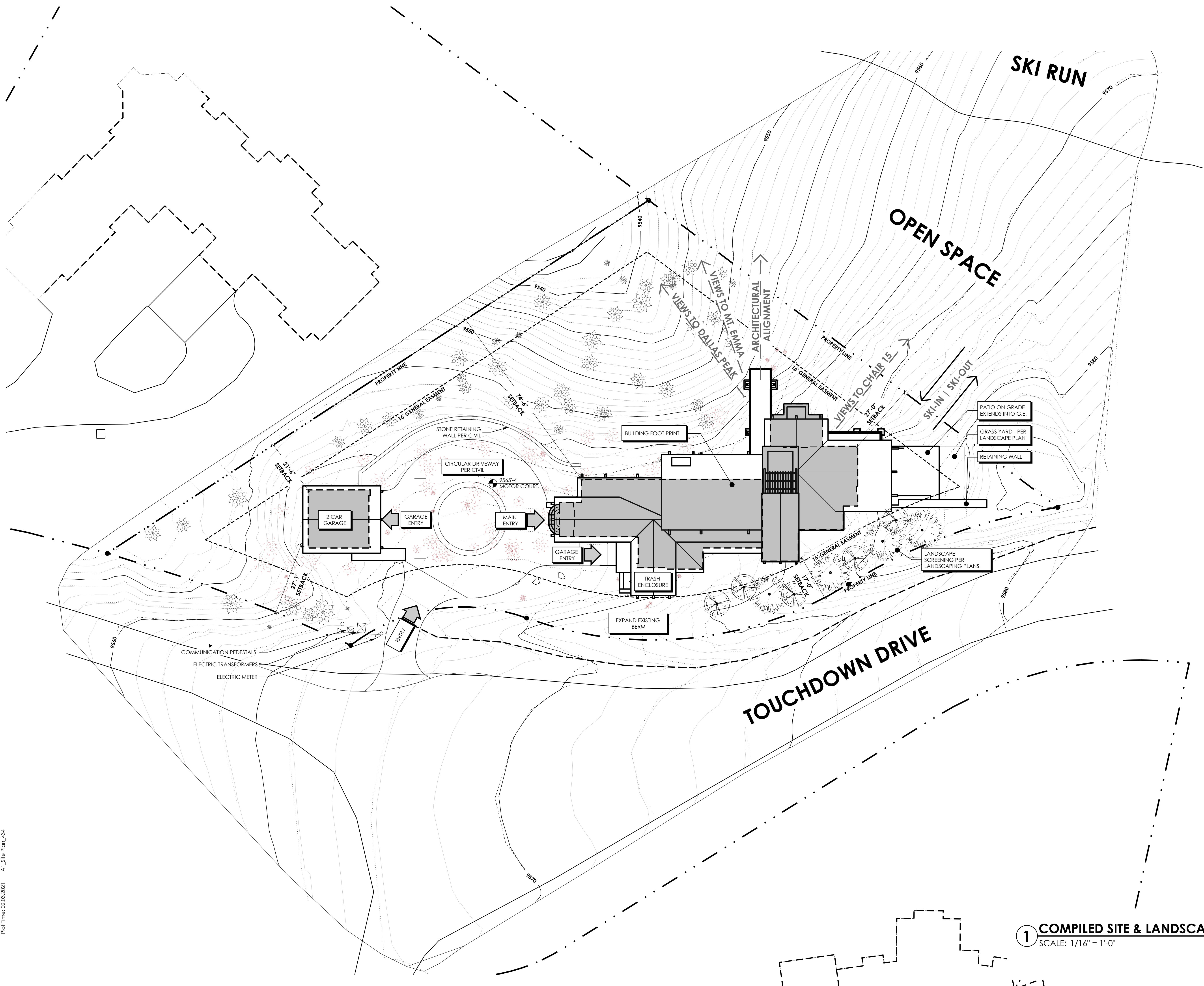

Tommy Hein
 ARCHITECTS
 Box 3327 Telluride, Colorado 970.728.1220 | 108 S. Oak St. Penthouse Colorado 81435 | www.TommyHein.com

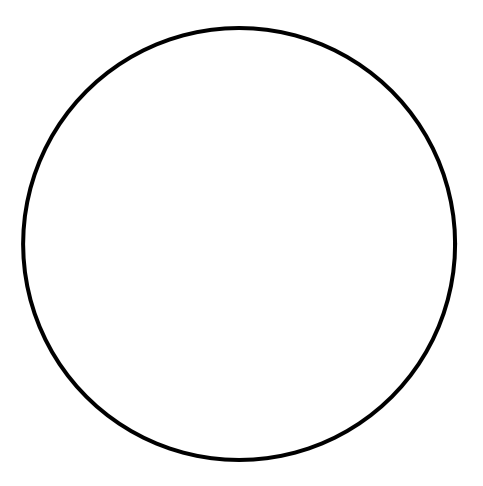

SUBMISSIONS

DATE	SUBMISSION
09.22.2020	CLIENT MEETING
09.29.2020	CLIENT MEETING
10.16.2020	PLAN REVIEW
11.05.2020	DRB REVIEW
01.25.2021	CLIENT REVIEW
02.03.2021	DRB SKETCH REVIEW

The Refuge

LOT 434
 TOUCHDOWN DR
 MTN. VILLAGE
 COLORADO

**COMPILED
 SITE &
 LANDSCAPE
 PLAN**

A.1.1

1 COMPILED SITE & LANDSCAPE PLAN
 SCALE: 1/16" = 1'-0"



Plot Title: 02.03.2021 - A1_Site Plan_434

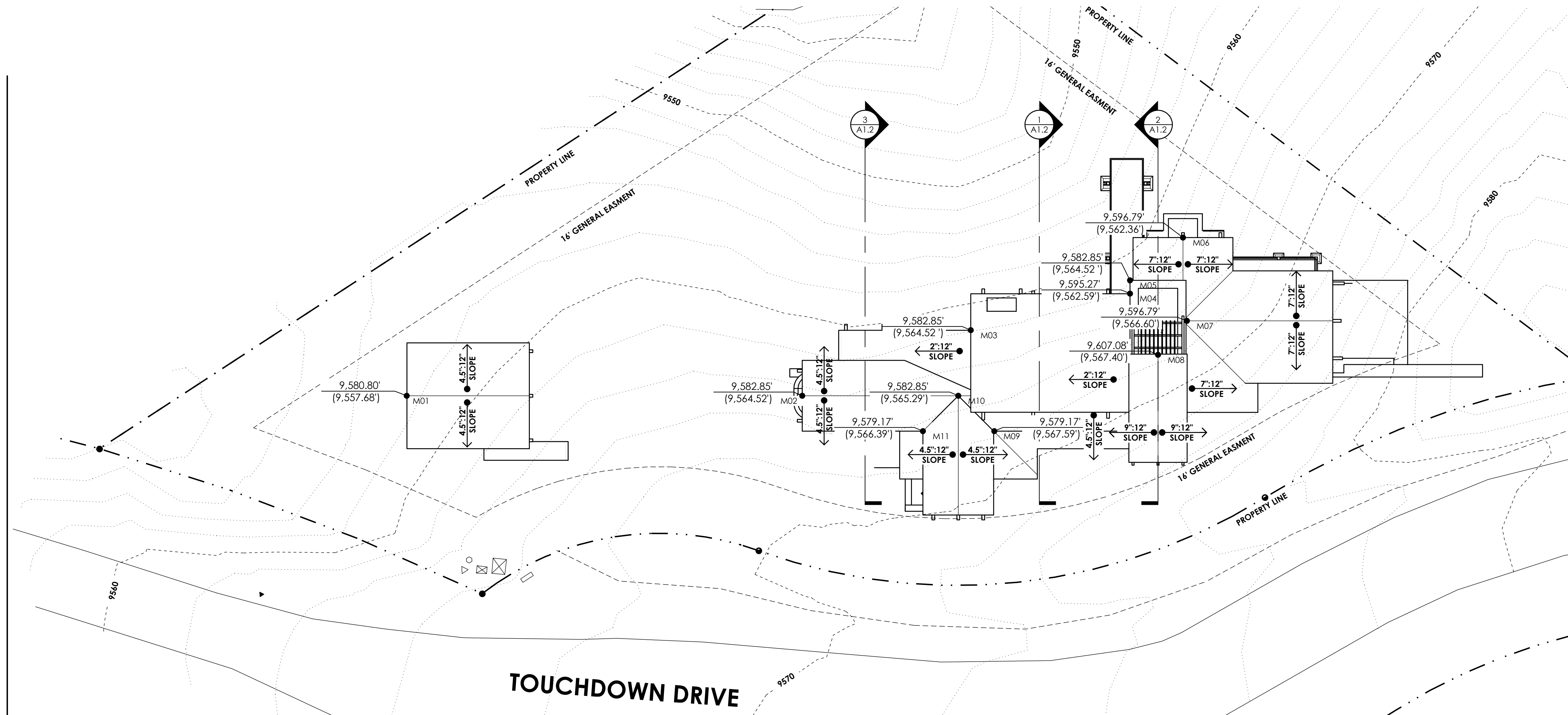

1 ROOF HEIGHT POINTS - MAXIMUM HEIGHTS
SCALE: 1/16" = 1'-0"

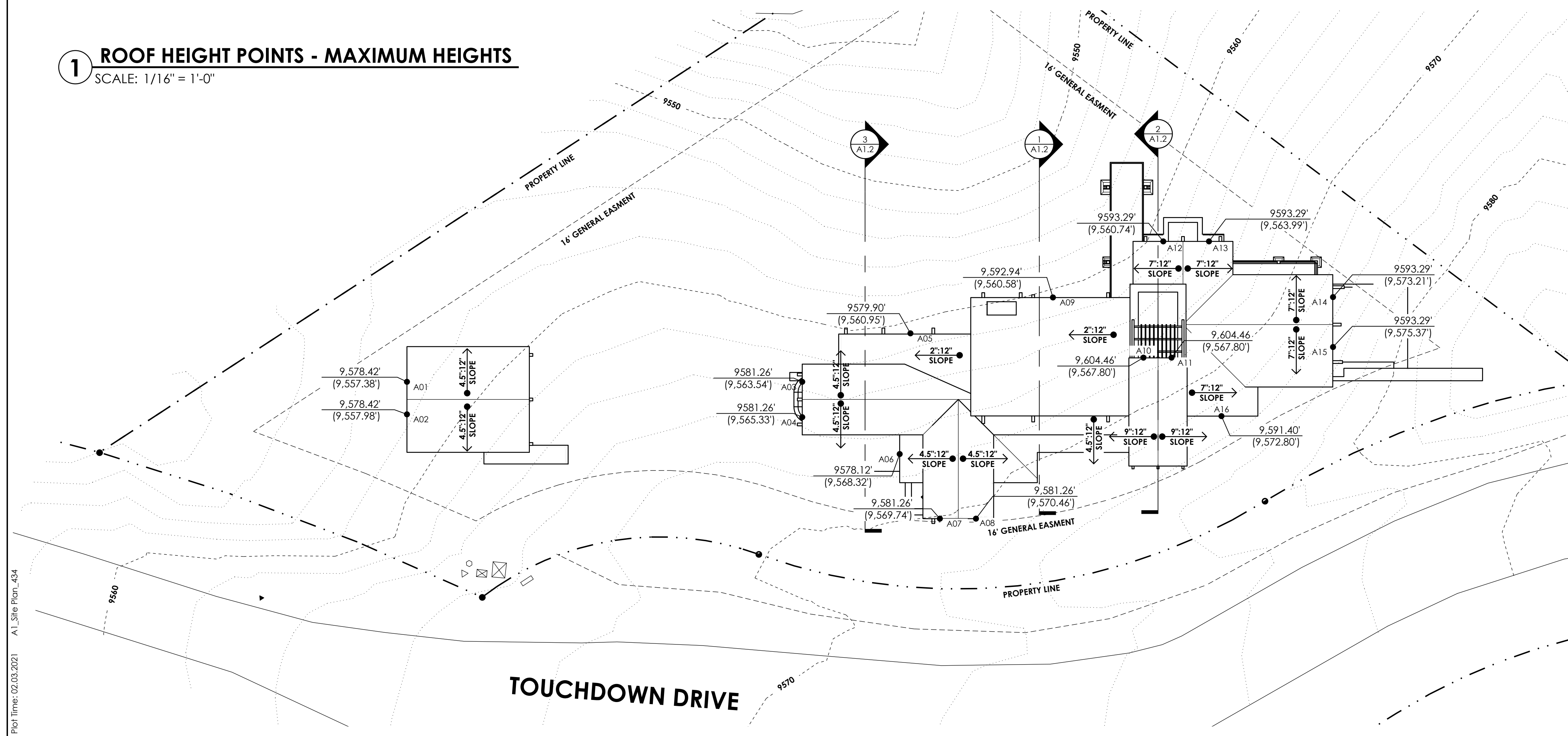

2 ROOF HEIGHT POINTS - MAXIMUM AVERAGE HEIGHTS
SCALE: 1/16" = 1'-0"

LOT 434 TOUCHDOWN DR					
TELLURIDE MOUNTAIN VILLAGE					02-02-21
MAXIMUM ROOF HEIGHT CALCULATIONS					
ROOF POINT #	ROOF POINT ELEVATION	NATURAL GRADE ELEVATION	CALCULATED ROOF HEIGHT (FEET) ABOVE NATURAL GRADE	PROPOSED GRADE ELEVATION BELOW	CALCULATED ROOF HEIGHT (FEET) ABOVE FINISH GRADE
M01	9,580.80	(9,557.68)	23.12	9,562.04	18.76
M02	9,582.85	(9,564.52)	18.33	9,565.33	17.52
M03	9,582.78	(9,562.06)	20.72	9,563.49	19.29
M04	9,595.27	(9,562.59)	32.68	9,564.74	30.53
M05	9,597.00	(9,561.86)	35.14	9,564.77	32.23
M06	9,596.79	(9,562.36)	34.43	9,565.43	31.36
M07	9,596.79	(9,566.60)	30.19	N/A	N/A
M08	9,607.08	(9,567.40)	39.68	N/A	N/A
M09	9,579.17	(9,567.59)	11.58	N/A	N/A
M10	9,582.85	(9,565.29)	17.56	N/A	N/A
M11	9,579.17	(9,566.39)	12.78	9,567.50	11.67

35' + 5' = MAX HEIGHT FOR GABLE ROOF FORMS
MAX HEIGHT = 39.68' (M08) | COMPLIANT BY 0.32

LOT 434 TOUCHDOWN DR				
TELLURIDE MOUNTAIN VILLAGE				02-02-21
MAXIMUM ROOF HEIGHT CALCULATIONS				
ROOF POINT #	ROOF ELEVATION	MOST RESTRICTIVE ELEVATION BELOW ROOF POINT	NG = NATURAL GRADE FG = FINISH GRADE	ROOF HEIGHT (FEET) ABOVE GRADE
A01	9,578.42	(9,557.38)	NG	21.04
A02	9,578.42	(9,557.98)	NG	20.44
A03	9,581.26	(9,563.54)	NG	17.72
A04	9,581.26	(9,565.33)	FG	15.93
A05	9,579.90	(9,560.95)	NG	18.95
A06	9,578.12	(9,568.32)	NG	9.80
A07	9,581.26	(9,569.74)	FG	11.52
A08	9,581.26	(9,570.46)	NG	10.80
A09	9,592.94	(9,560.58)	NG	32.36
A10	9,604.46	(9,566.99)	NG	37.47
A11	9,604.46	(9,567.80)	NG	36.66
A12	9,593.29	(9,560.74)	NG	32.55
A13	9,593.29	(9,563.99)	NG	29.30
A14	9,593.29	(9,573.21)	NG	20.08
A15	9,593.29	(9,575.37)	NG	17.92
A16	9,591.40	(9,572.80)	NG	18.60

AVERAGE HEIGHT: 21.94
MAX. AVERAGE ALLOWABLE: 30
COMPLIANT BY: 8.05

Tommy Hein
ARCHITECTS

Box 3327 108 S. Oak St. Penthouse
Telluride, Colorado 81435
970.728.1220 www.TommyHein.com

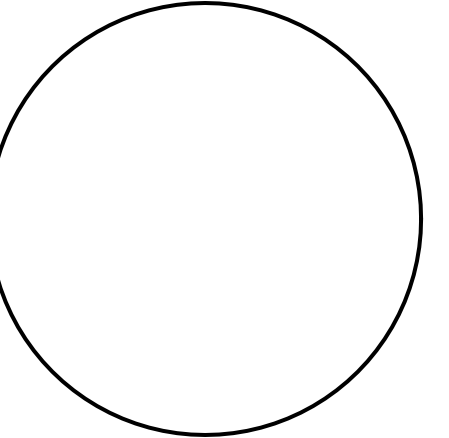

SUBMISSIONS

- | | |
|------------|-------------------|
| DATE: | SUBMISSION |
| 09.22.2020 | CLIENT MEETING |
| 09.29.2020 | CLIENT MEETING |
| 10.16.2020 | PLAN REVIEW |
| 11.05.2020 | DRB REVIEW |
| 01.25.2021 | CLIENT REVIEW |
| 02.03.2021 | DRB SKETCH REVIEW |

The Refuge

LOT 434
TOUCHDOWN DR
MTN. VILLAGE
COLORADO

**BUILDING
HEIGHT
CALCS.**

A1.2

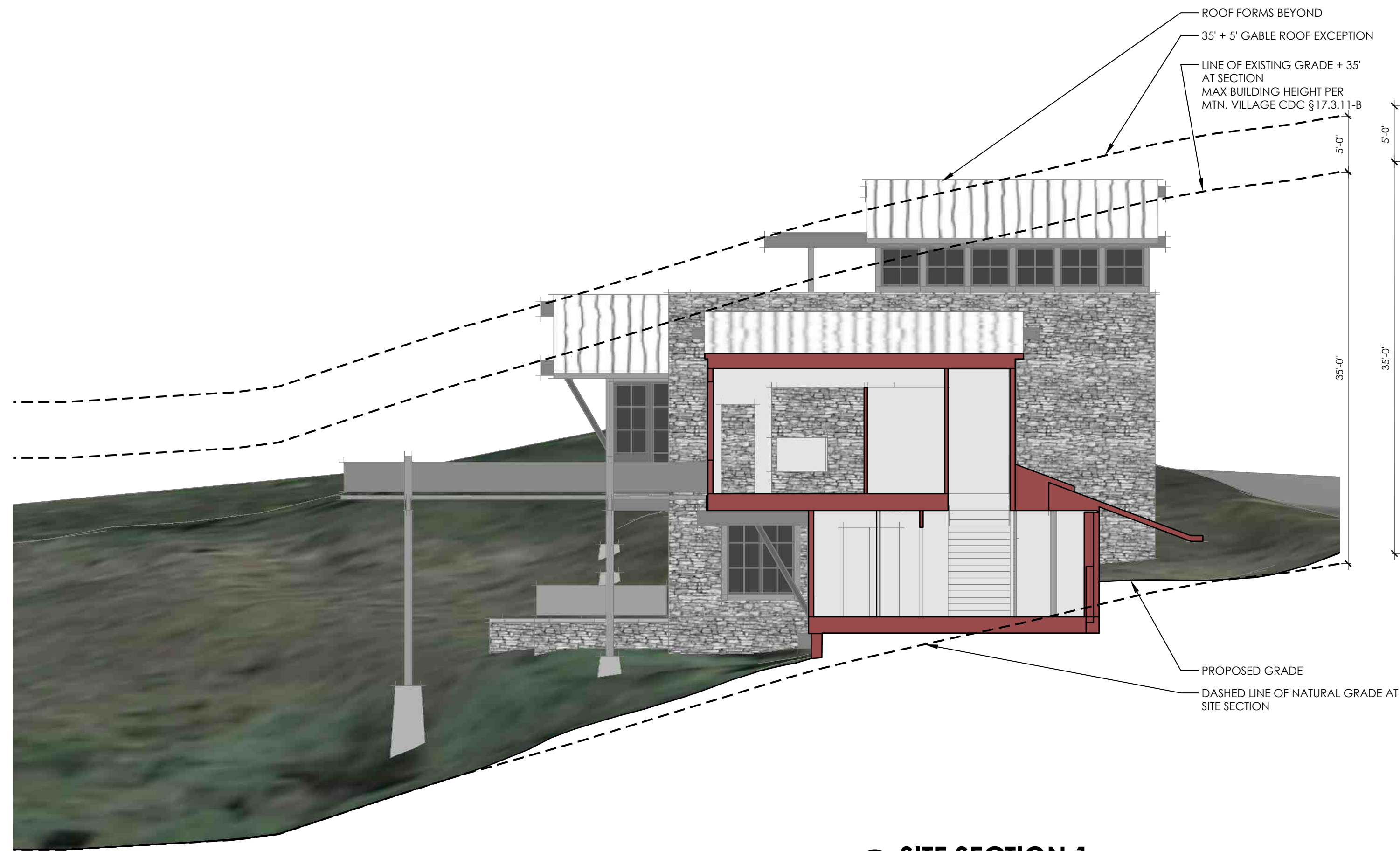

1 SITE SECTION 1
SCALE: 1/8" = 1'-0"

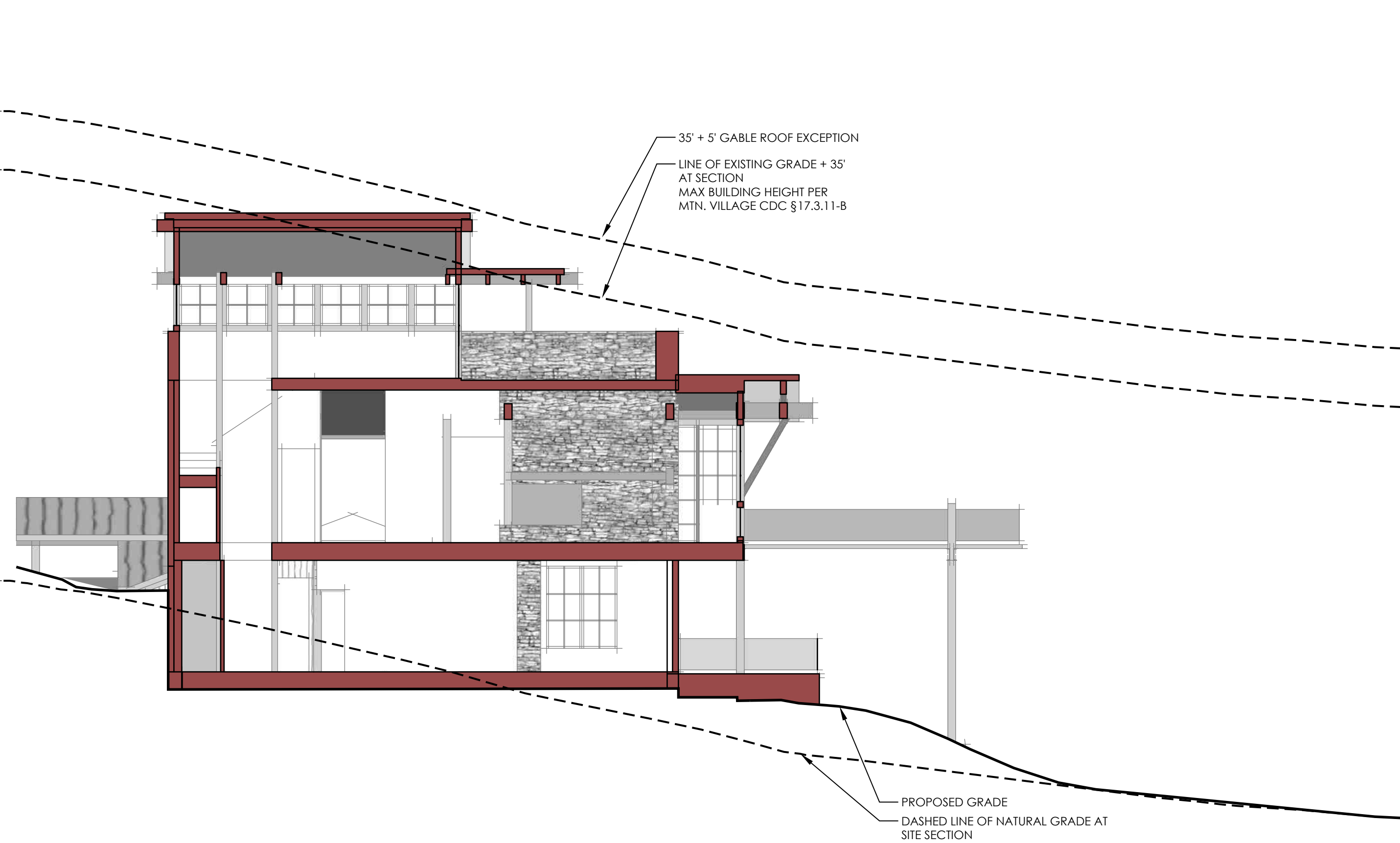

2 SITE SECTION 2 THROUGH HIGHEST RIDGE
SCALE: 1/8" = 1'-0"

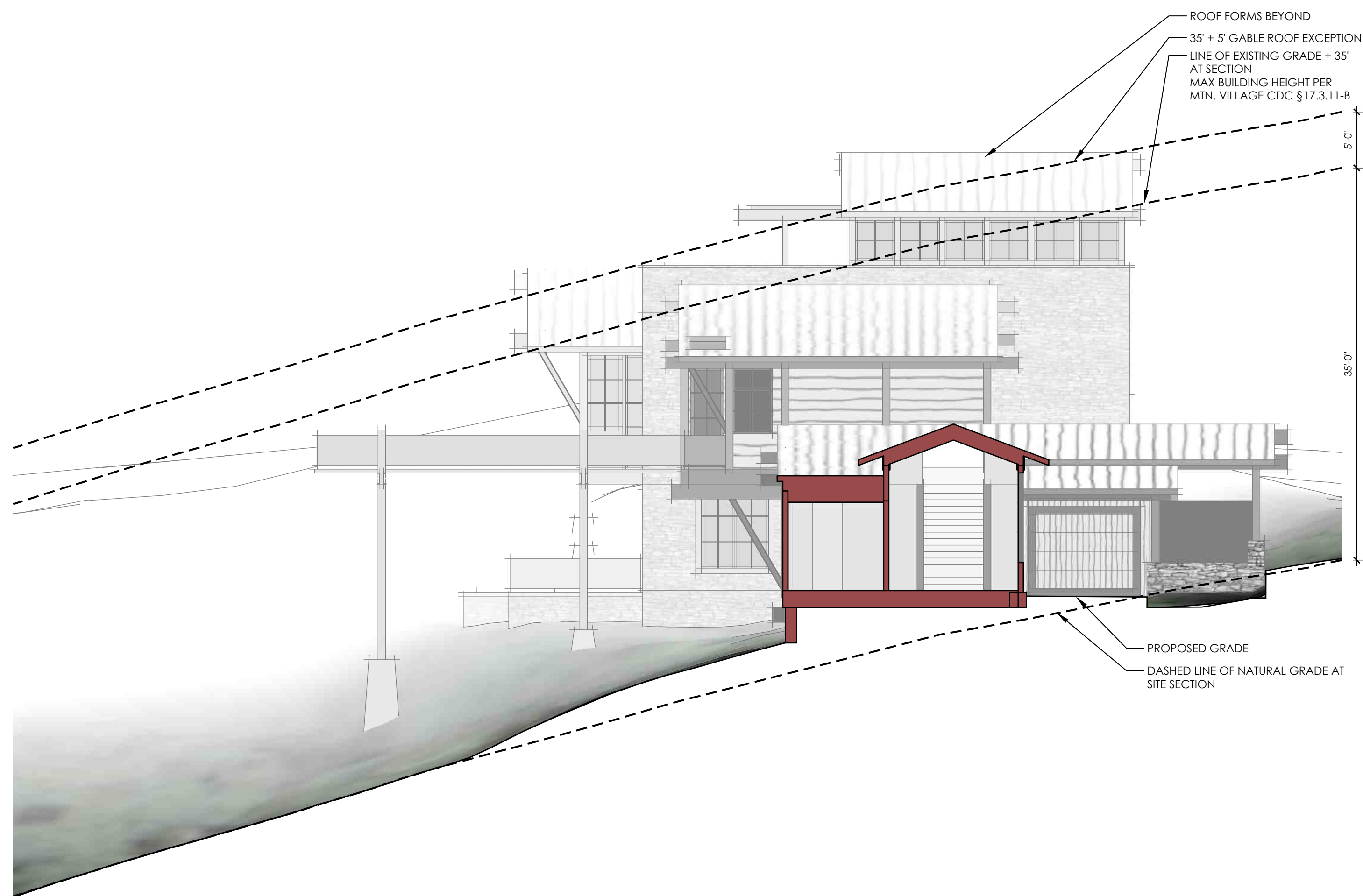

3 SITE SECTION 3
SCALE: 1/8" = 1'-0"



4 35' SITE OFFSET - 3D VIEW
SCALE: PERSPECTIVE

Tommy Hein
ARCHITECTS
Box 3327 Telluride, Colorado 970.728.1220 | 108 S. Oak St. Penthouse Colorado 81435 | www.TommyHein.com

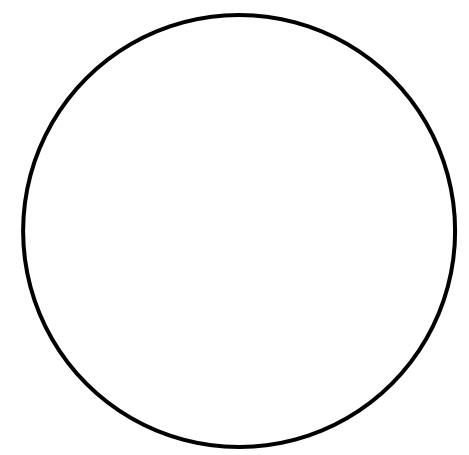

SUBMISSIONS

DATE	SUBMISSION
09.22.2020	CLIENT MEETING
09.29.2020	CLIENT MEETING
10.16.2020	PLAN REVIEW
11.05.2020	DRB REVIEW
01.25.2021	CLIENT REVIEW
02.03.2021	DRB SKETCH REVIEW

The Refuge

LOT 434
TOUCHDOWN DR
MTN. VILLAGE
COLORADO

SITE SECTIONS

A1.3

FLOOR AREA SUMMARY	
TOTAL LIVABLE:	4,883 FT ²
GARAGE/MECH:	1,147 FT ²
GROSS ENCLOSED:	6,030 FT ²
TERRACES & DECKS:	1,835 FT ²

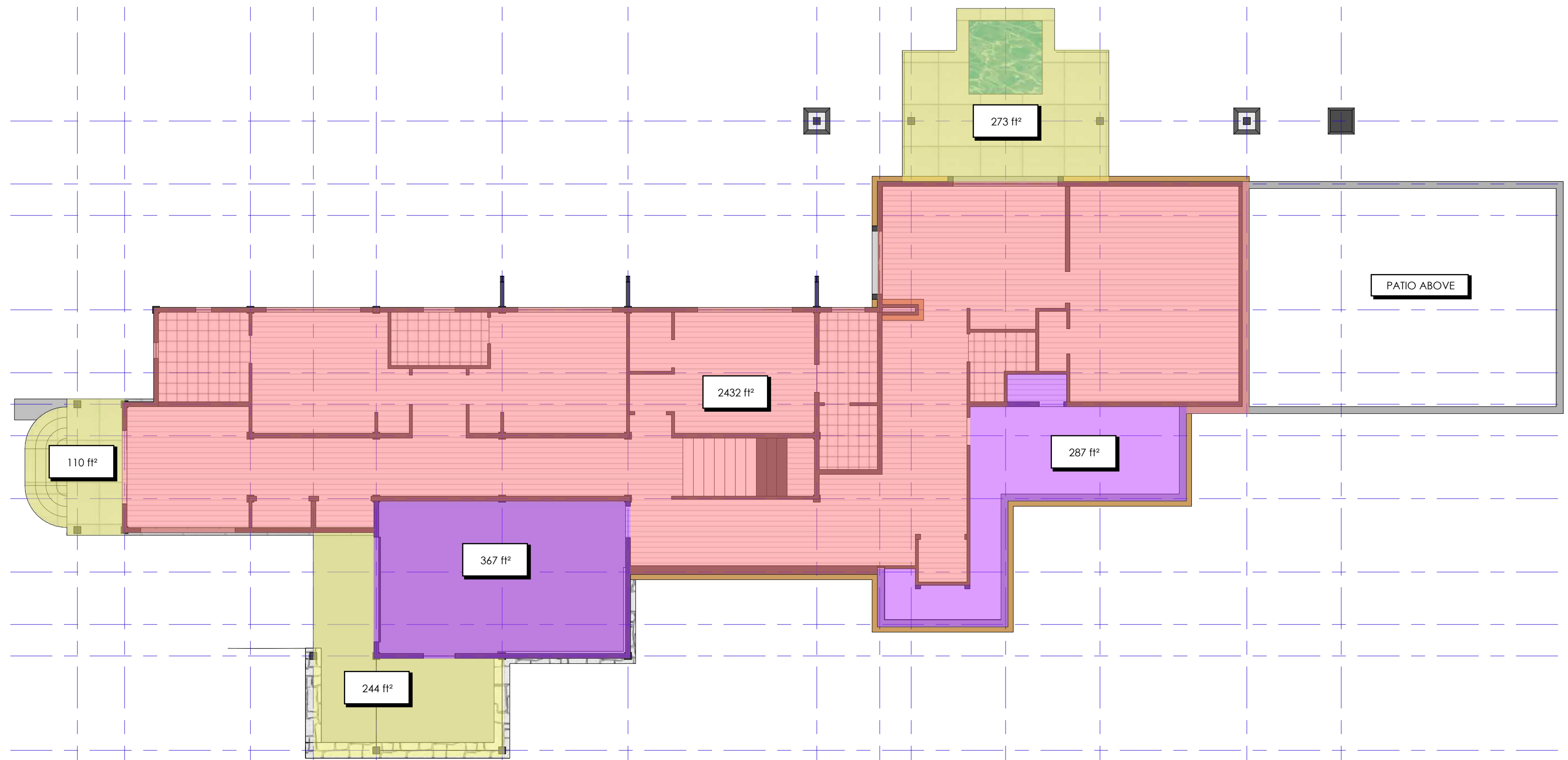
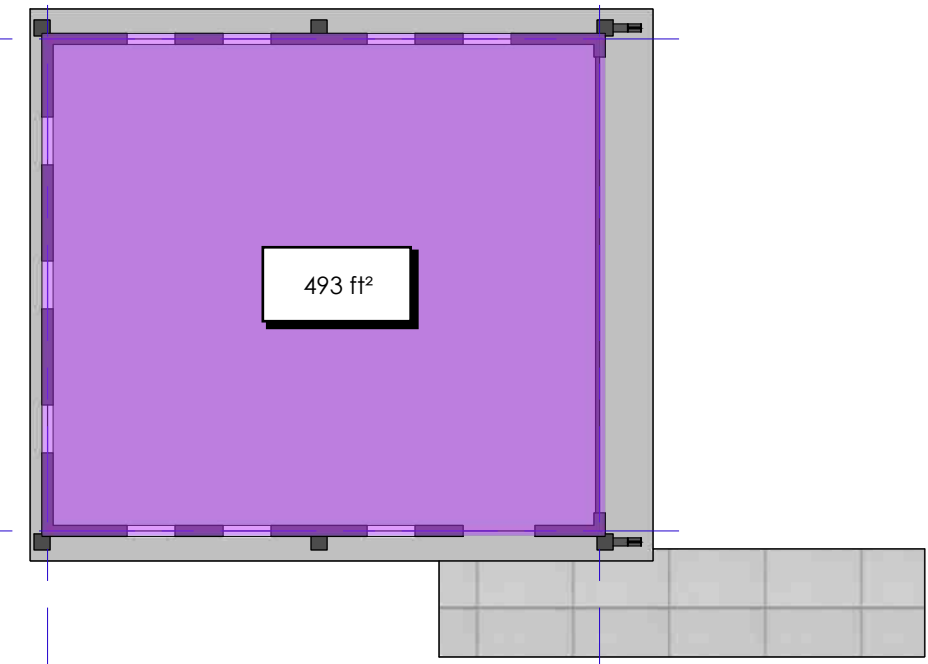

1 LEVEL 01 PLAN
SCALE: 1/8" = 1'-0"

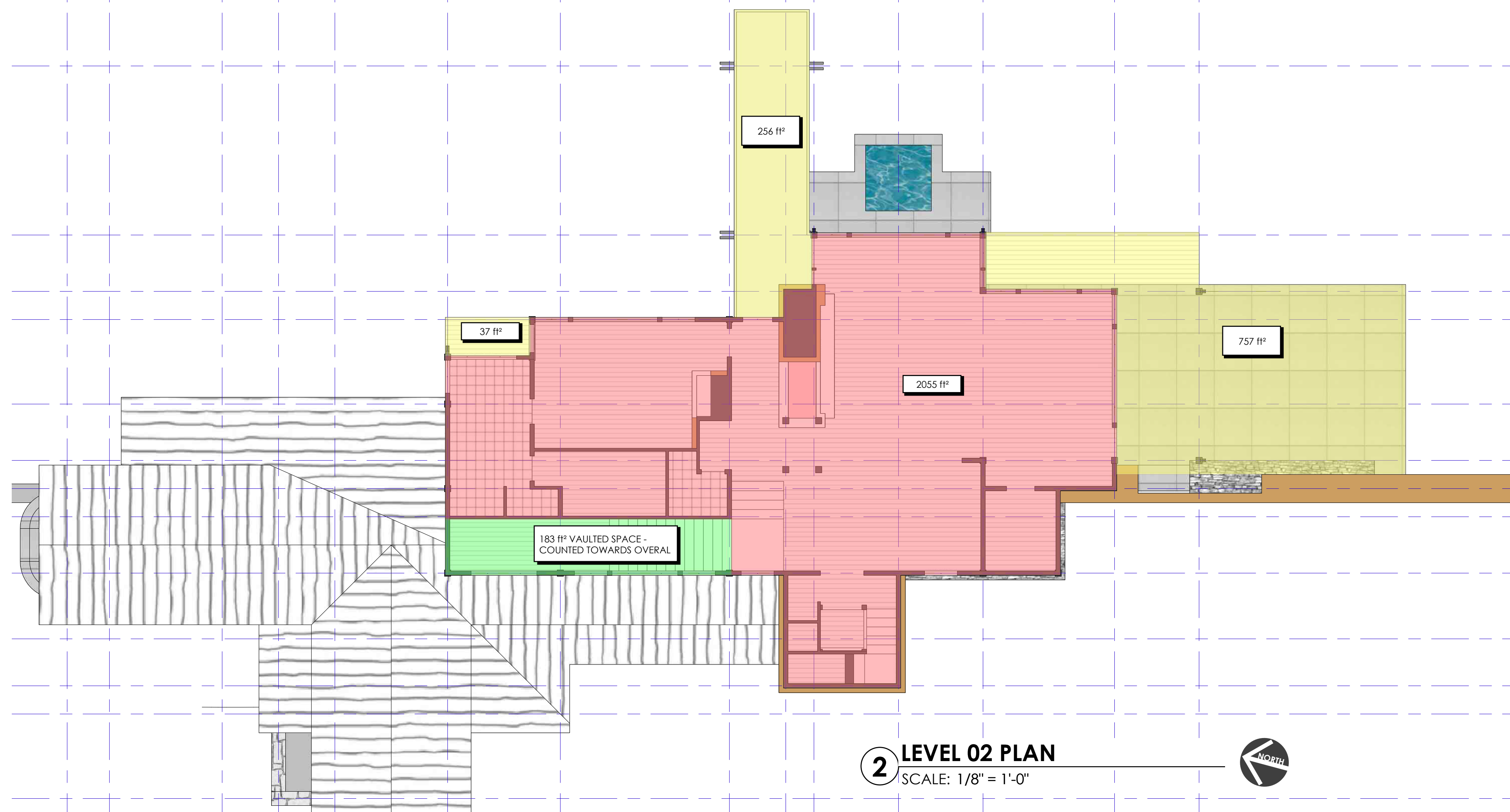

2 LEVEL 02 PLAN
SCALE: 1/8" = 1'-0"

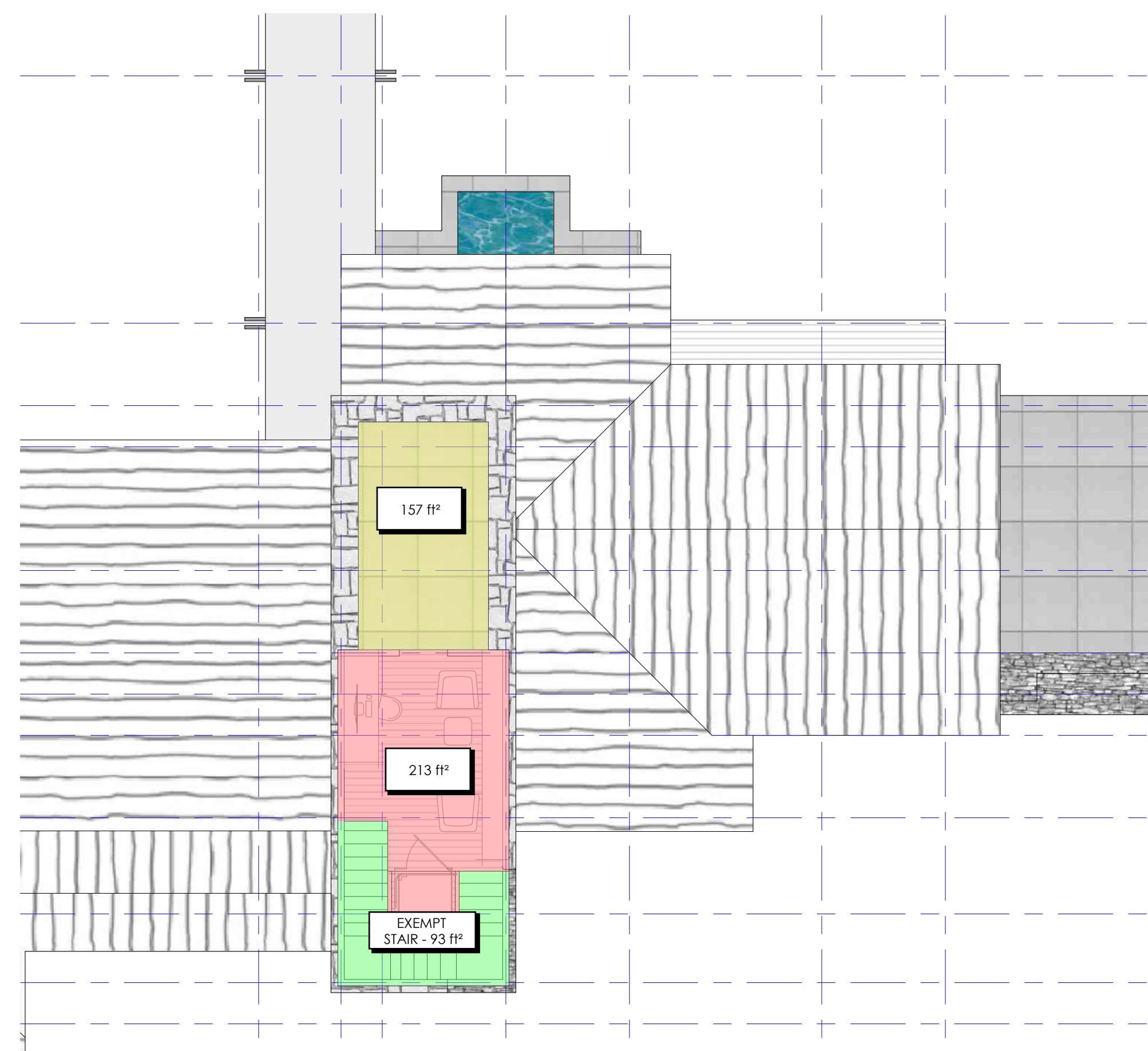

3 LEVEL 03 PLAN
SCALE: 1/8" = 1'-0"



Tommy Hein
ARCHITECTS
Box 3327 Telluride, Colorado 970.728.1220 | 108 S. Oak St. Colorado 81435 | Penthouse 81435 www.TommyHein.com

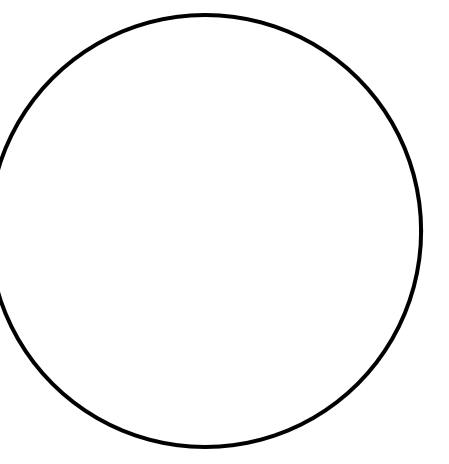

SUBMISSIONS	
DATE:	SUBMISSION
09.22.2020	CLIENT MEETING
09.29.2020	CLIENT MEETING
10.16.2020	PLAN REVIEW
11.05.2020	DRB REVIEW
01.25.2021	CLIENT REVIEW
02.03.2021	DRB SKETCH REVIEW

The Refuge

LOT 434
TOUCHDOWN DR
MTN. VILLAGE
COLORADO

FLOOR AREA
SUMMARY

A.2.0

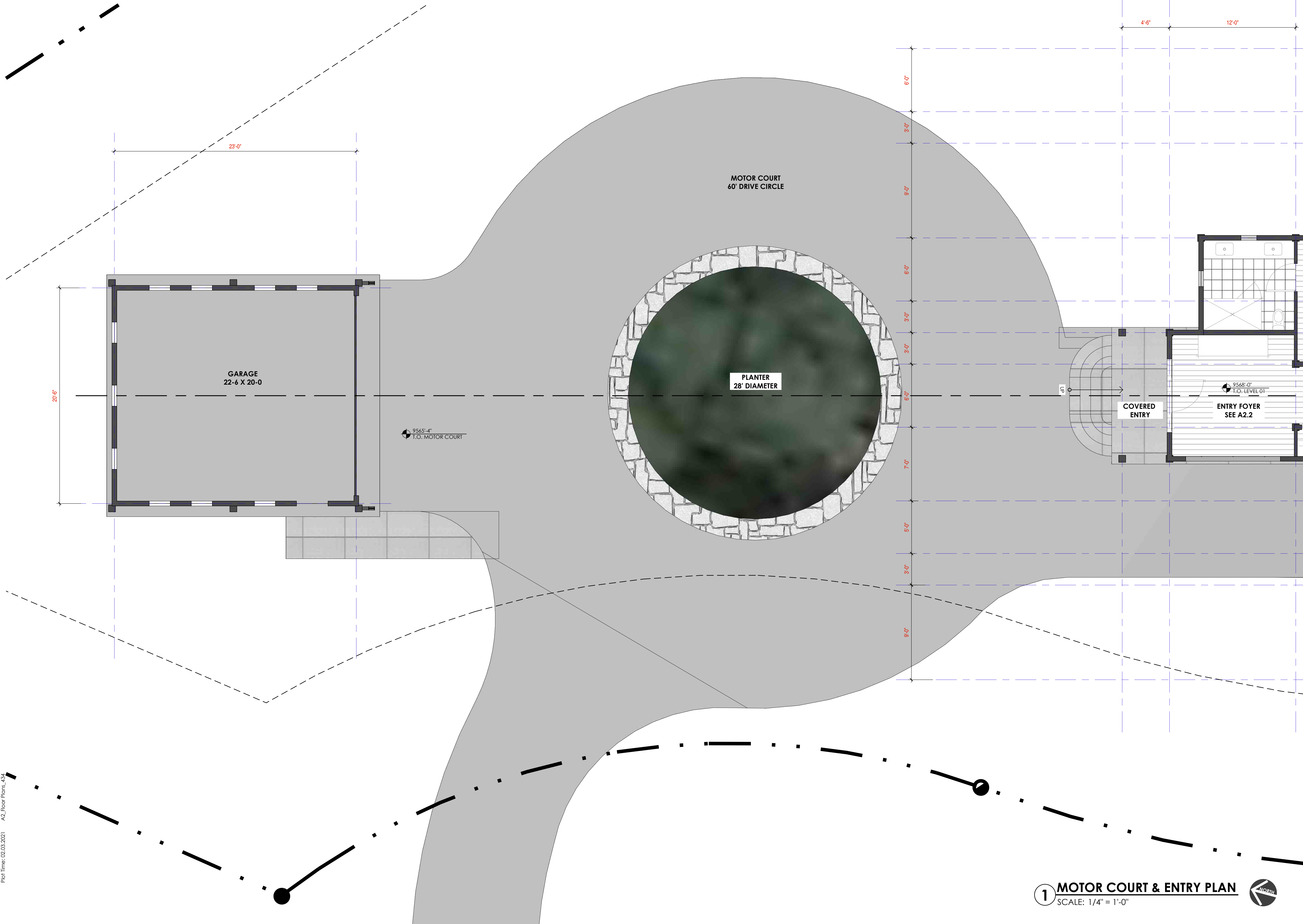

Tommy Hein
 ARCHITECTS
 Box 3327 Telluride, Colorado 970.728.1220 | 108 S. Oak St. Colorado 81435 | Penthouse 81435 www.TommyHein.com

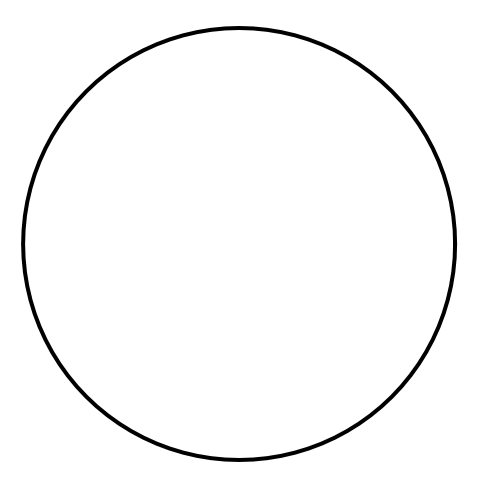

SUBMISSIONS

DATE	SUBMISSION
09.22.2020	CLIENT MEETING
09.29.2020	CLIENT MEETING
10.16.2020	PLAN REVIEW
11.05.2020	DRB REVIEW
01.25.2021	CLIENT REVIEW
02.03.2021	DRB SKETCH REVIEW

The Refuge

LOT 434
 TOUCHDOWN DR
 MTN. VILLAGE
 COLORADO

**MOTOR
 COURT &
 ENTRY PLAN**

A.1

1 MOTOR COURT & ENTRY PLAN
 SCALE: 1/4" = 1'-0"

Plot Time: 02.03.2021 A2_Floor Plans_A3

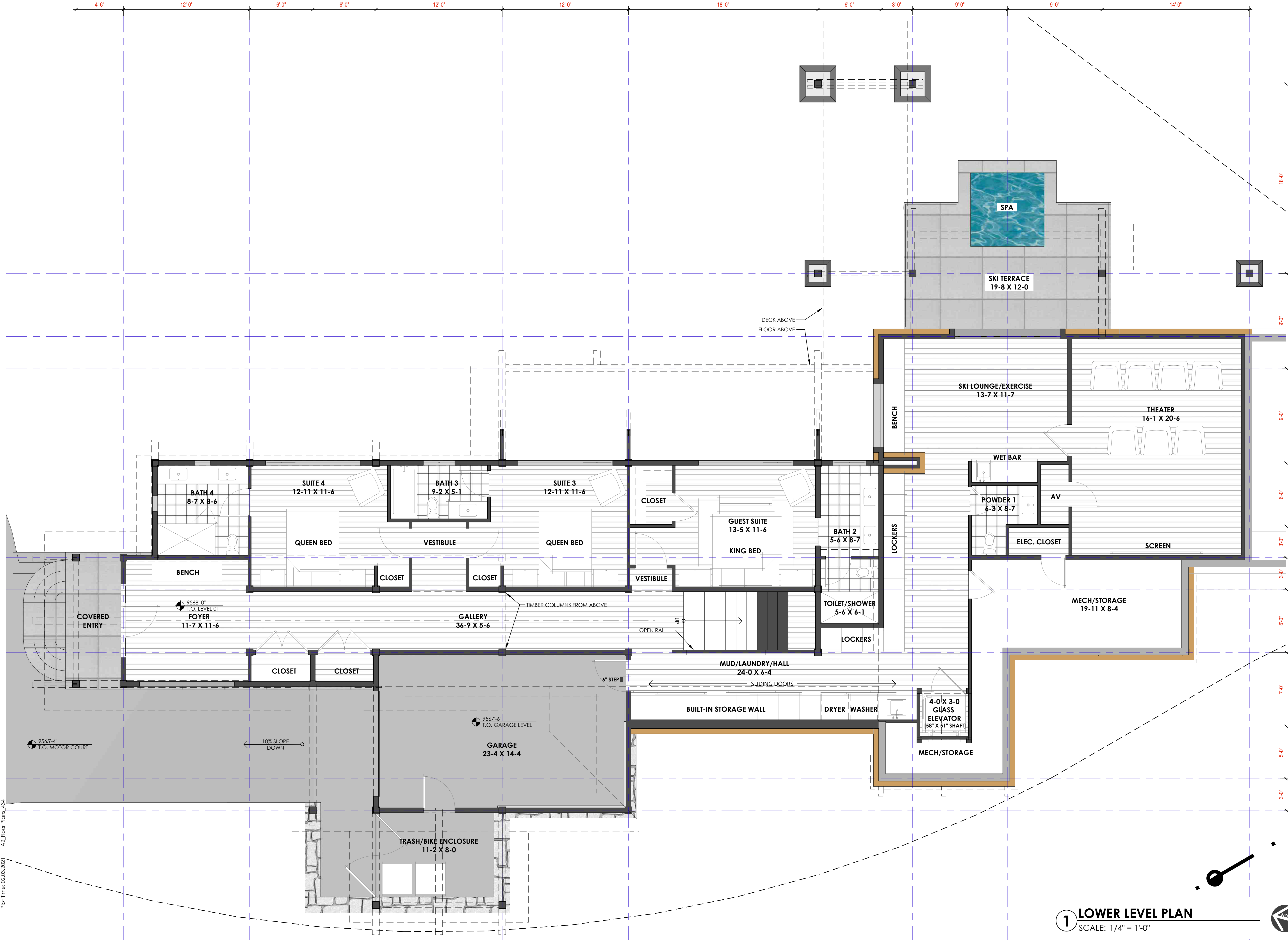

Tommy Hein
 ARCHITECTS
 Box 3327 Telluride, Colorado 970.728.1220 | 108 S. Oak St. Penthouse Colorado 81435 | www.TommyHein.com

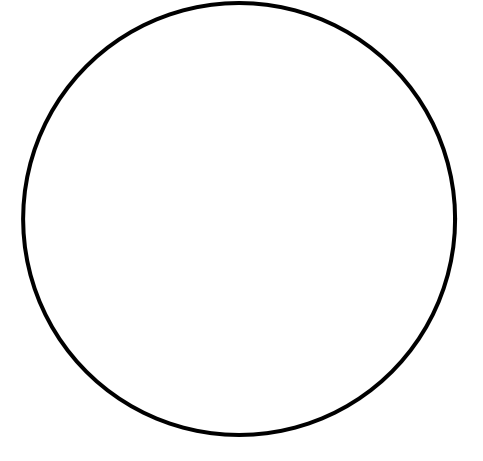

SUBMISSIONS

DATE:	SUBMISSION
09.22.2020	CLIENT MEETING
09.29.2020	CLIENT MEETING
10.16.2020	PLAN REVIEW
11.05.2020	DRB REVIEW
01.25.2021	CLIENT REVIEW
02.03.2021	DRB SKETCH REVIEW

The Refuge

LOT 434
 TOUCHDOWN DR
 MTN. VILLAGE
 COLORADO

**LOWER LEVEL
 PLAN**

A2.2

1 LOWER LEVEL PLAN
 SCALE: 1/4" = 1'-0"

Plot Time: 02.03.2021 A2_Floor Plans_434

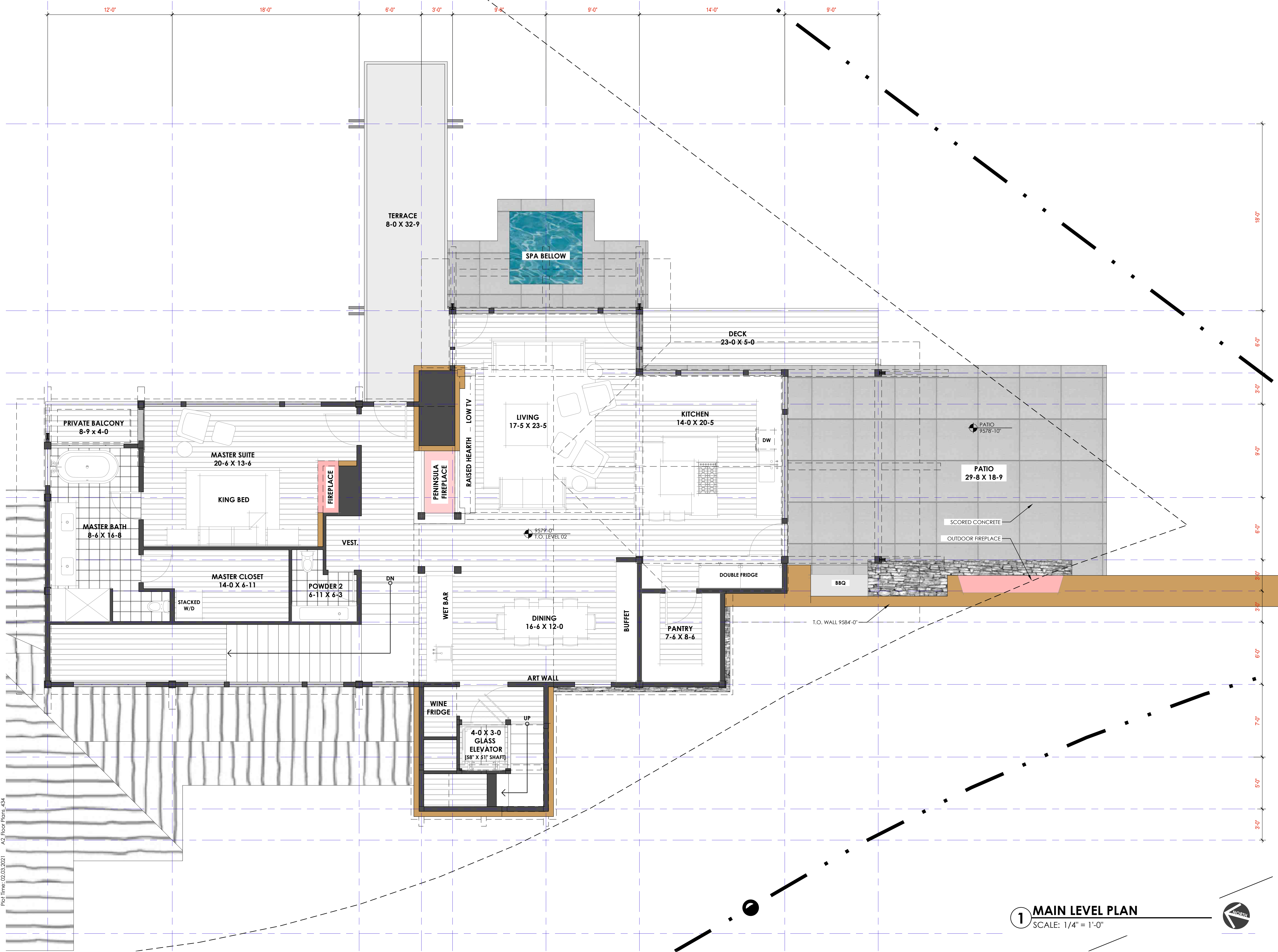

Plot Title: 02.03.2021 A2_Floor Plans_434

Tommy Hein
ARCHITECTS
Box 3327 Telluride, CO 970.728.1220 | 108 S. Oak St. Colorado 81435 | Penthouse 81435 www.TommyHein.com

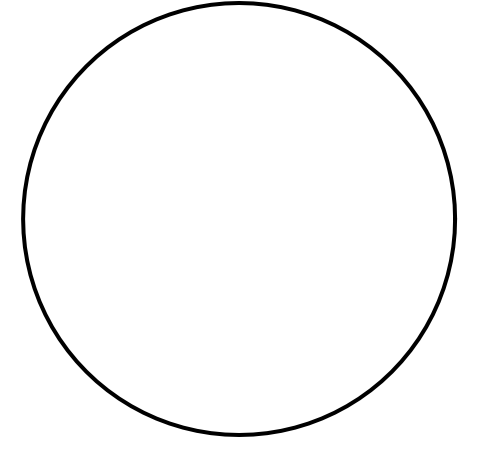

SUBMISSIONS

DATE:	SUBMISSION
09.22.2020	CLIENT MEETING
09.29.2020	CLIENT MEETING
10.16.2020	PLAN REVIEW
11.05.2020	DRB REVIEW
01.25.2021	CLIENT REVIEW
02.03.2021	DRB SKETCH REVIEW

The Refuge

LOT 434
TOUCHDOWN DR
MTN. VILLAGE
COLORADO

**MAIN LEVEL
PLAN**

A2.3

1 MAIN LEVEL PLAN
SCALE: 1/4" = 1'-0"



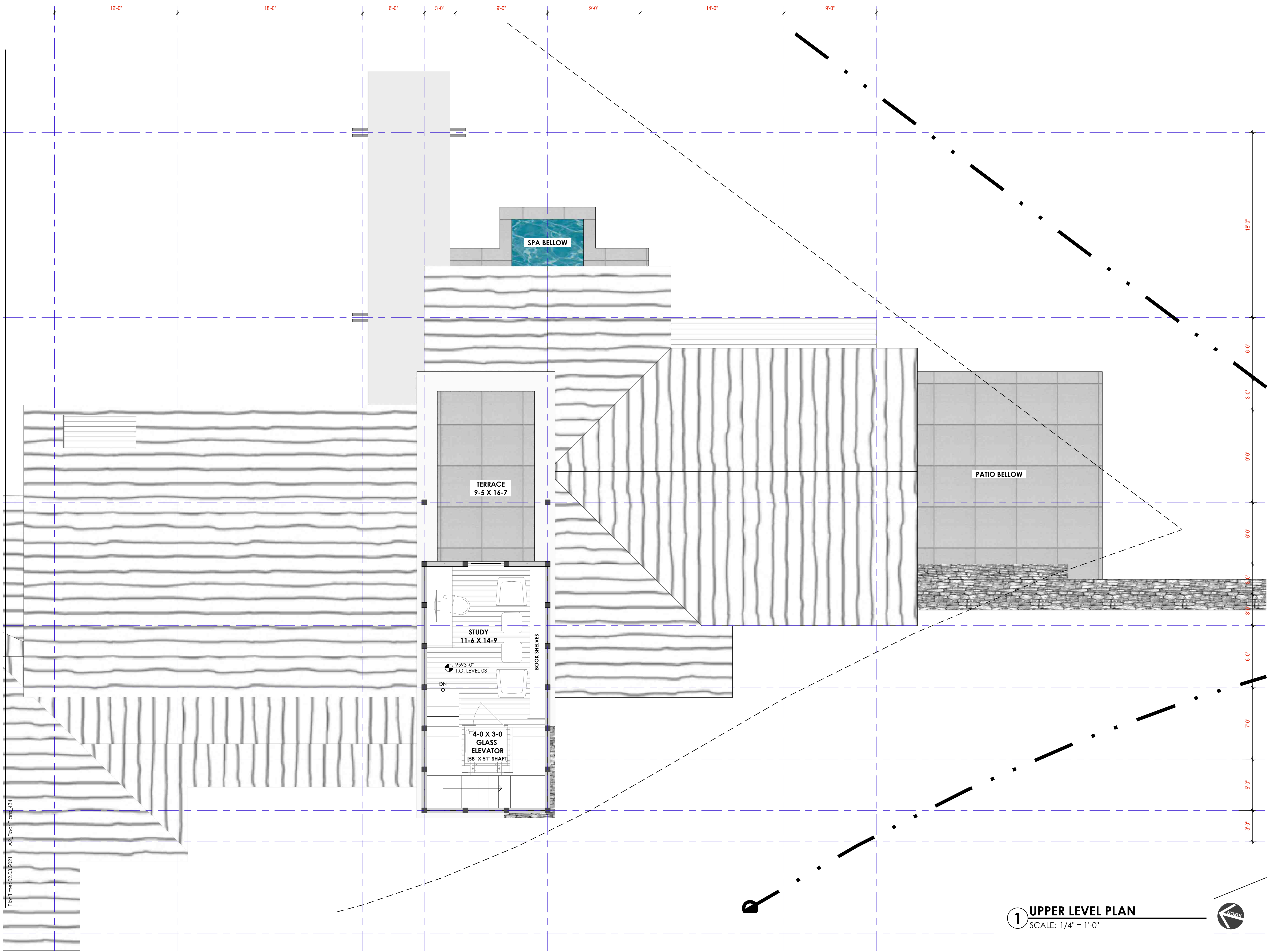

Tommy Hein
 ARCHITECTS
 Box 3327 Telluride, Colorado 970.728.1220 | 108 S. Oak St. Colorado 81435 | Penthouse 81435 www.TommyHein.com

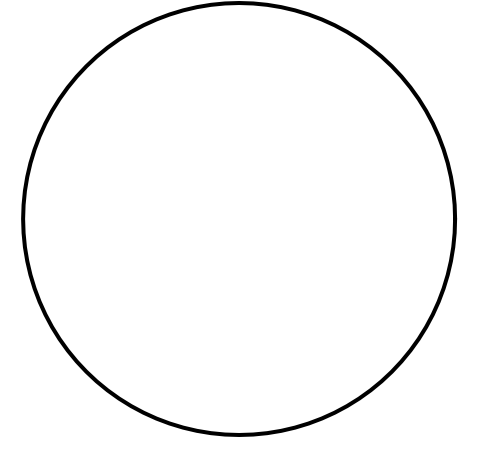

SUBMISSIONS

DATE	SUBMISSION
09.22.2020	SUBMISSION
09.29.2020	CLIENT MEETING
10.16.2020	CLIENT MEETING
11.05.2020	DRB REVIEW
01.25.2021	DRB REVIEW
02.03.2021	DRB SKETCH REVIEW

The Refuge
 LOT 434
 TOUCHDOWN DR
 MTN. VILLAGE
 COLORADO

UPPER LEVEL PLAN

A2.4

Pro Times 02.03.2021 A2_FloorPlan_434

1 UPPER LEVEL PLAN
 SCALE: 1/4" = 1'-0"



EXTERIOR MATERIALS

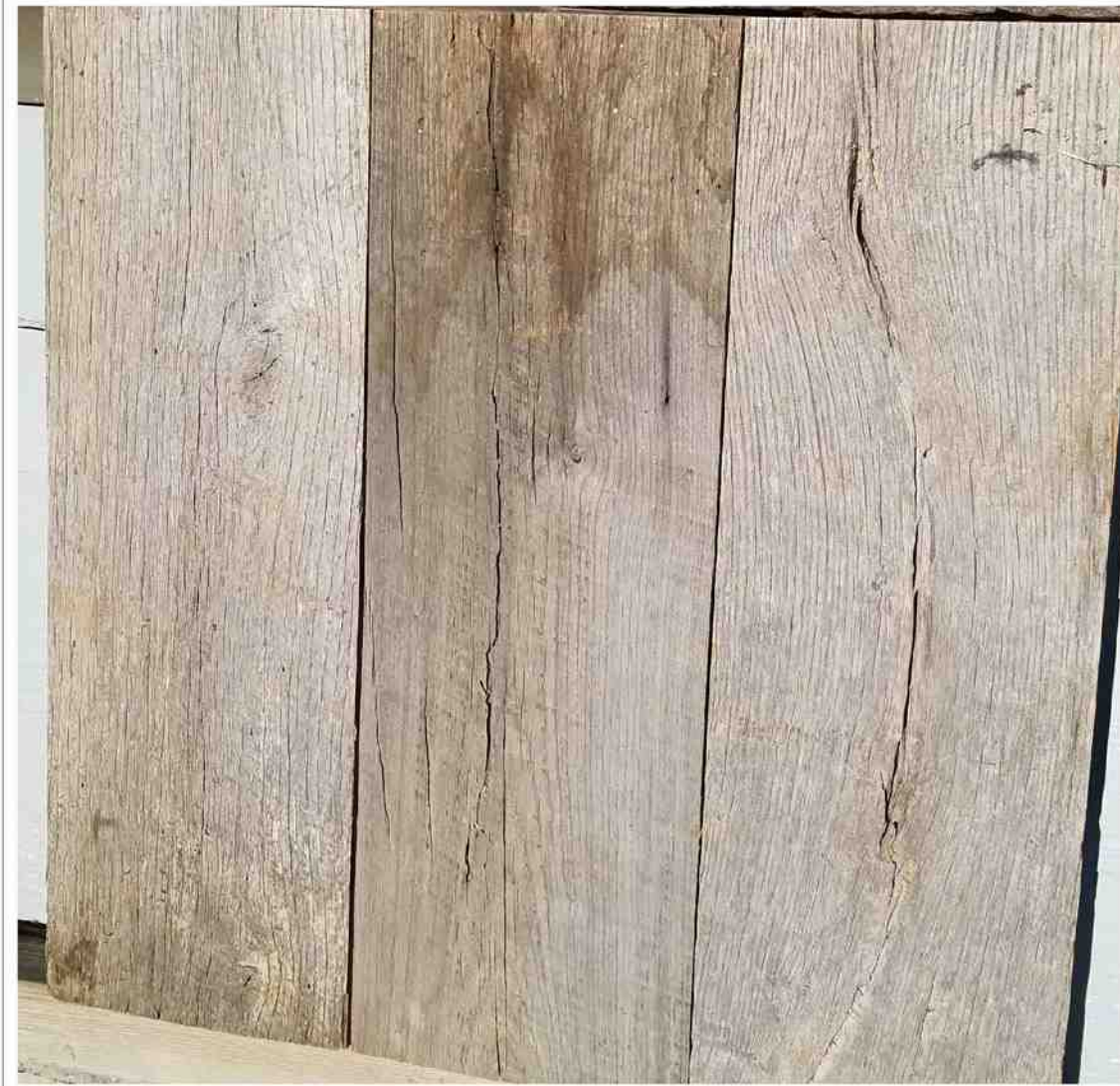

MATERIAL PALLETTE

BLEACHED GREY BARNWOOD
 NATURAL - ROUGH
 VERTICAL SIDING AND SOFFITS -
 4" BOARDS
 HORIZONTAL SIDING - 12" BOARDS
 MILLED, BUTT JOINTS, 1/4" DARK
 STAIN REVEAL

W1

STONE VENEER
 "COTTONWOOD" LIMESTONE
 4-5" THICK
 NUETRAL WARM GREY
 LARGE BLOCK PATTERN

S1

VINTAGE WOOD TIMBERS
 ROUGH-HEWN
 FADED WITH LIGHT
 WEATHERPROOF STAIN
 APPROX SIZE PER PLAN

W2

STEEL WINDOWS & DOORS
 PAINTED CHARCOAL BLACK
 PER SCHEDULE

F1

DYNAMIC

Tommy Hein
 ARCHITECTS
 Box 3327 Telluride, Colorado 970.728.1220 | 108 S. Oak St. Colorado 81435 | Penthouse 81435 www.TommyHein.com

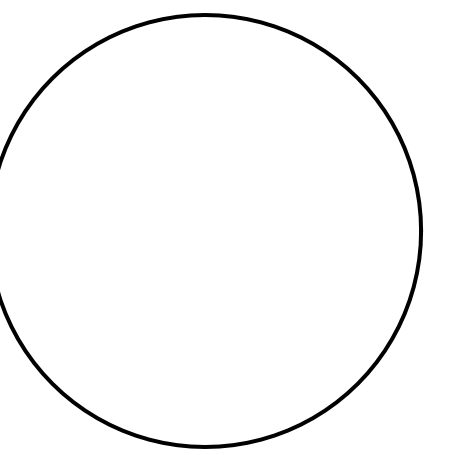

SUBMISSIONS

DATE: SUBMISSION
 09.22.2020 CLIENT MEETING
 09.29.2020 CLIENT MEETING
 10.16.2020 PLAN REVIEW
 11.05.2020 DRB REVIEW
 01.25.2021 CLIENT REVIEW
 02.03.2021 DRB SKETCH REVIEW

EXTERIOR MATERIALS



ROOFING
 STEEL - RUSTED PATINA
 STANDING SEAM - 16" RIMS O.C.

R1

FLAGSTONE PATIO
 "COTTONWOOD" LIMESTONE
 4-5" THICK
 NUETRAL WARM GREY
 BUFF TILE PATTERN 2' X 4'

S2

BOARDFORM CONCRETE
 HIGHLY TEXTURED
 NUETRAL WARM GREY

C1

EXPOSED STEEL STRUCTURE
 W. C. OR 3/16 BENT PLATE STEEL,
 PENETROL PATINA FINISH BLACK
 FOR INTERIOR, PAINTED BROZE
 PATINA FOR EXTERIOR

M1

The Refuge

LOT 434
 TOUCHDOWN DR
 MTN. VILLAGE
 COLORADO

EXTERIOR MATERIALS

A3.0



GROSS FACADE MATERIAL SUMMARY	
MATERIAL	AMOUNT IN SQ. FT.
STONE VENEER	3,043
WOOD & TIMBER SIDING	3,179
FENESTRATION	2,020
TOTAL VERT. SURFACE	8,242
TOTAL PERCENTAGE STONE:	36.92%
35% REQUIRED PER CDC COMPLIANT BY:	1.92%
TOTAL PERCENTAGE FENESTRATION:	24.50%
40% MAXIMUM PER CDC COMPLIANT BY:	15.49%

Tommy Hein
ARCHITECTS
Box 3327 108 S. Oak St. Penthouse
Telluride, Colorado 81435
970.728.1220 www.TommyHein.com

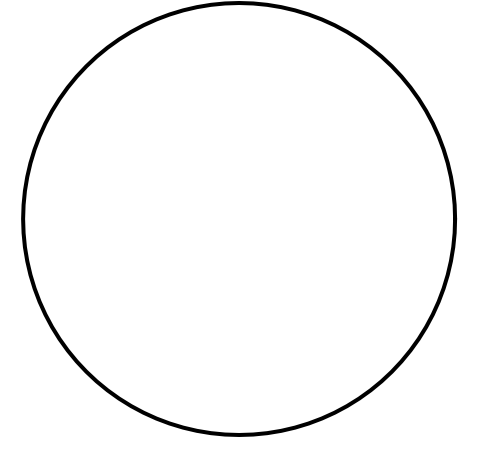

SUBMISSIONS
DATE: SUBMISSION
09.22.2020 CLIENT MEETING
09.29.2020 CLIENT MEETING
10.16.2020 PLAN REVIEW
11.05.2020 DRB REVIEW
01.25.2021 CLIENT REVIEW
02.03.2021 DRB SKETCH REVIEW

1 EAST ELEVATION
SCALE: 1/8" = 1'-0"

EAST ELEVATION MATERIAL SUMMARY	
MATERIAL	AMOUNT IN SQ. FT.
STONE VENEER	780
WOOD & TIMBER SIDING	878
FENESTRATION	650
UPPER TERRACE HIDDEN	0
TRASH ENCLOSURE HIDDEN	0

EAST GARAGE ELEV. MATERIAL SUMMARY	
MATERIAL	AMOUNT IN SQ. FT.
STONE VENEER	74
WOOD & TIMBER SIDING	201
FENESTRATION	32
UPPER TERRACE HIDDEN	0
TRASH ENCLOSURE HIDDEN	0

WEST GARAGE ELEV. MATERIAL SUMMARY	
MATERIAL	AMOUNT IN SQ. FT.
STONE VENEER	40
WOOD & TIMBER SIDING	185
FENESTRATION	48
UPPER TERRACE HIDDEN	0
TRASH ENCLOSURE HIDDEN	0

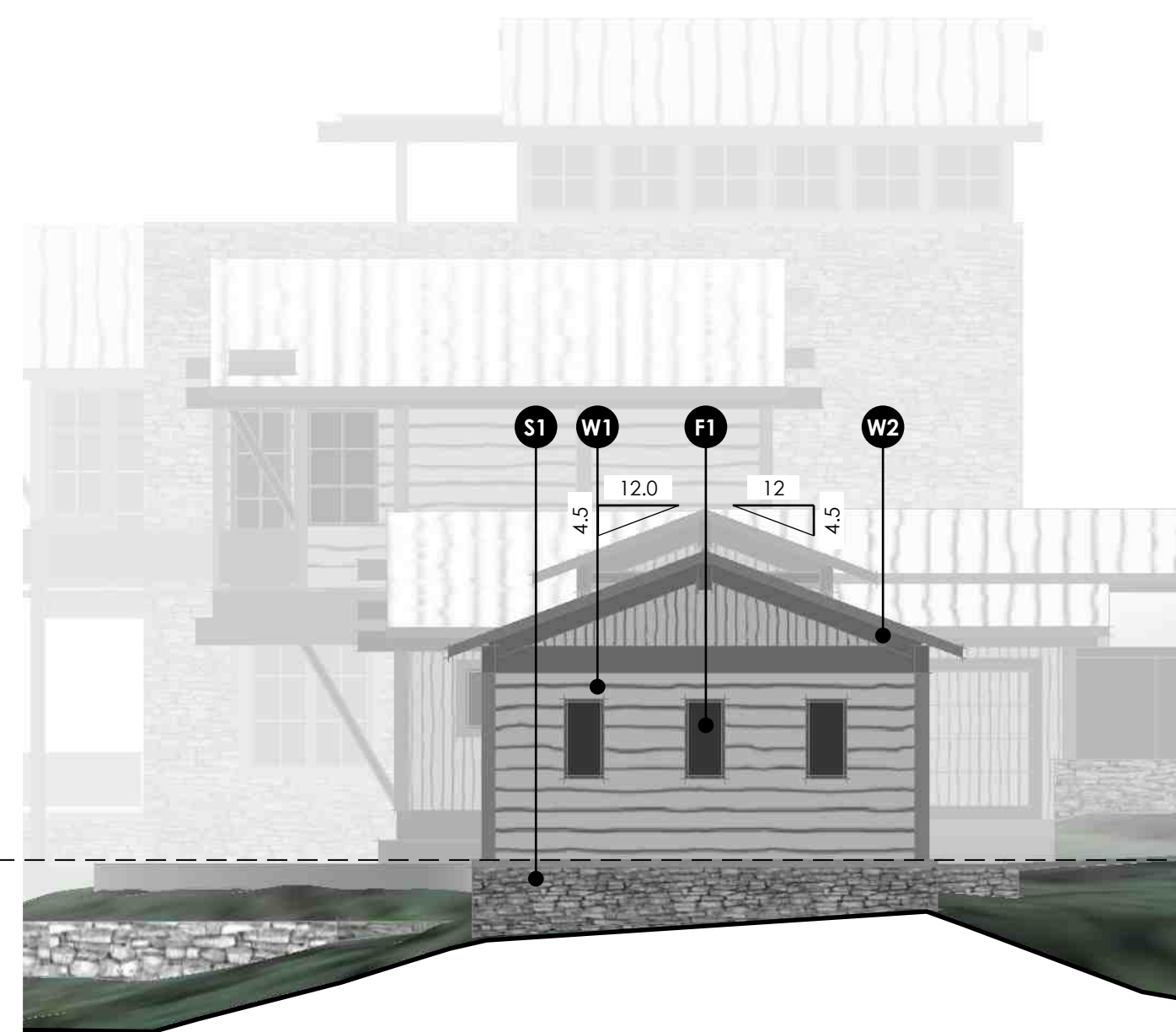

2 NORTH GARAGE ELEVATION
SCALE: 1/8" = 1'-0"

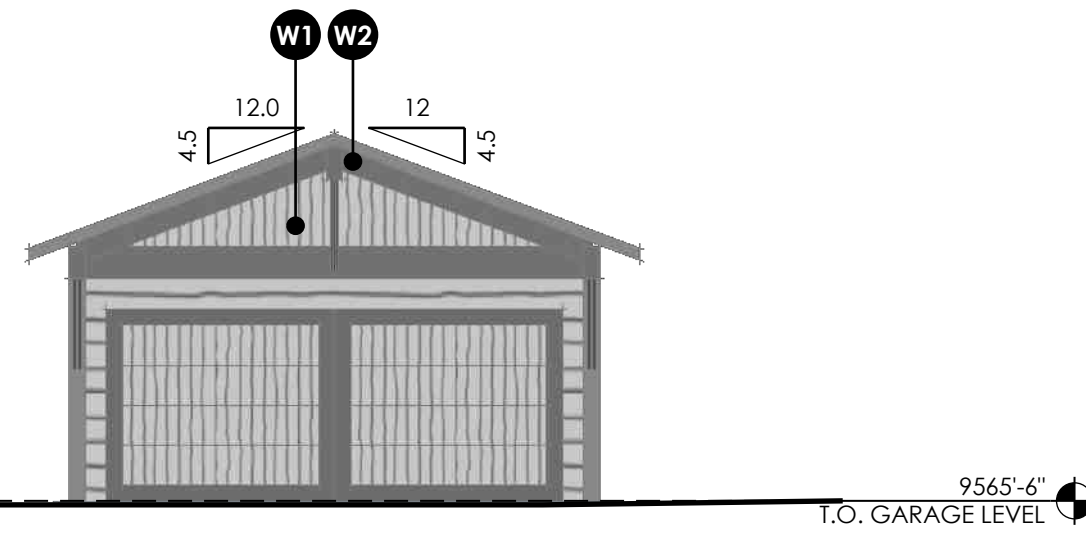

3 SOUTH GARAGE ELEVATION
SCALE: 1/8" = 1'-0"

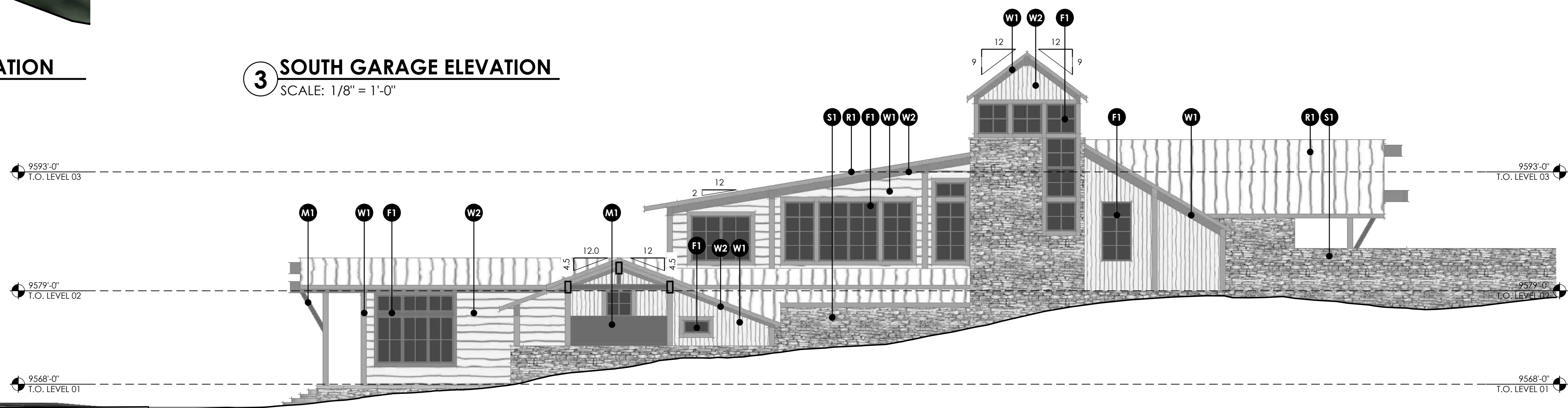

4 WEST ELEVATION
SCALE: 1/8" = 1'-0"

WEST ELEVATION MATERIAL SUMMARY	
MATERIAL	AMOUNT IN SQ. FT.
STONE VENEER	692
WOOD & TIMBER SIDING	1,043
FENESTRATION	391
UPPER TERRACE HIDDEN	38
TRASH ENCLOSURE HIDDEN	91

NORTH GARAGE ELEV. MATERIAL SUMMARY	
MATERIAL	AMOUNT IN SQ. FT.
STONE VENEER	60
WOOD & TIMBER SIDING	226
FENESTRATION	24
UPPER TERRACE HIDDEN	0
TRASH ENCLOSURE HIDDEN	0

SOUTH GARAGE ELEV. MATERIAL SUMMARY	
MATERIAL	AMOUNT IN SQ. FT.
STONE VENEER	0
WOOD & TIMBER SIDING	98
FENESTRATION	152
UPPER TERRACE HIDDEN	0
TRASH ENCLOSURE HIDDEN	0

The Refuge

LOT 434
TOUCHDOWN DR
MTN. VILLAGE
COLORADO

COMPILED
EAST & WEST
ELEVATIONS

A3.1

Plot Title: 02.03.2021 A3_Elevations_434

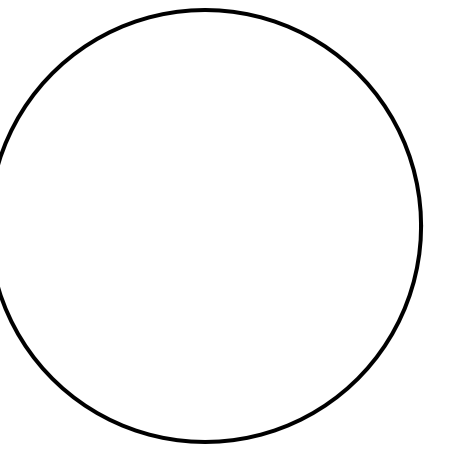

SUBMISSIONS

DATE:	SUBMISSION
09.22.2020	CLIENT MEETING
09.29.2020	CLIENT MEETING
10.16.2020	PLAN REVIEW
11.05.2020	DRB REVIEW
01.25.2021	CLIENT REVIEW
02.03.2021	DRB SKETCH REVIEW

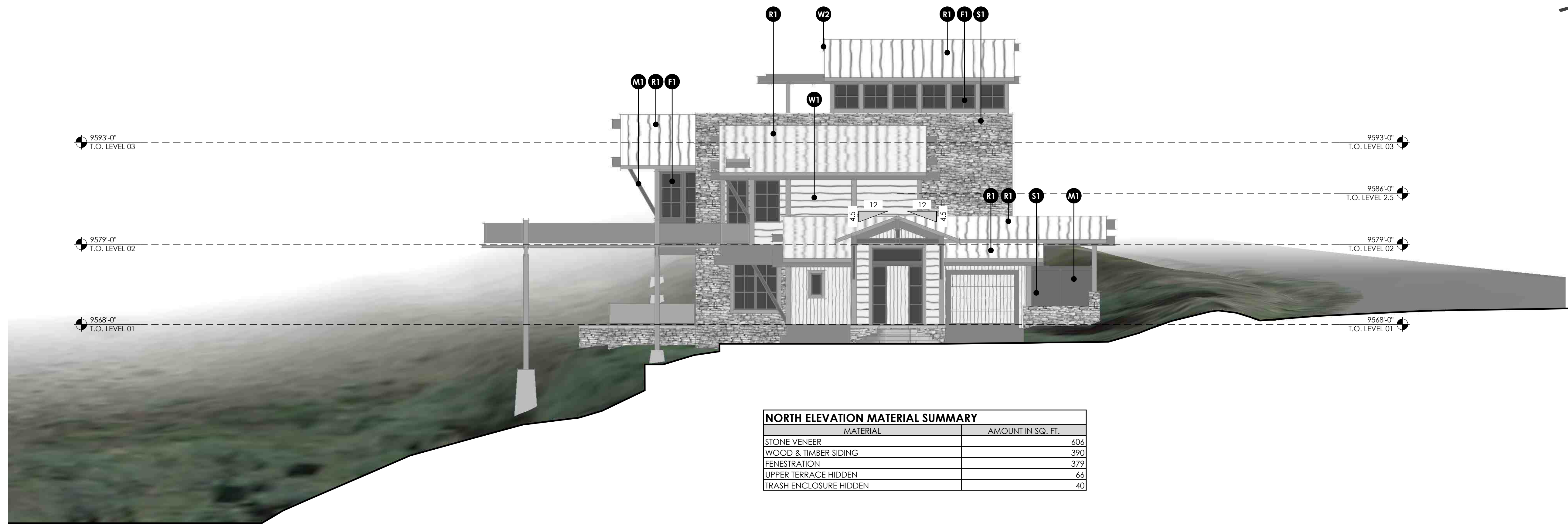

MATERIAL	AMOUNT IN SQ. FT.
STONE VENEER	606
WOOD & TIMBER SIDING	390
FENESTRATION	379
UPPER TERRACE HIDDEN	66
TRASH ENCLOSURE HIDDEN	40

1 NORTH ELEVATION
SCALE: 1/8" = 1'-0"

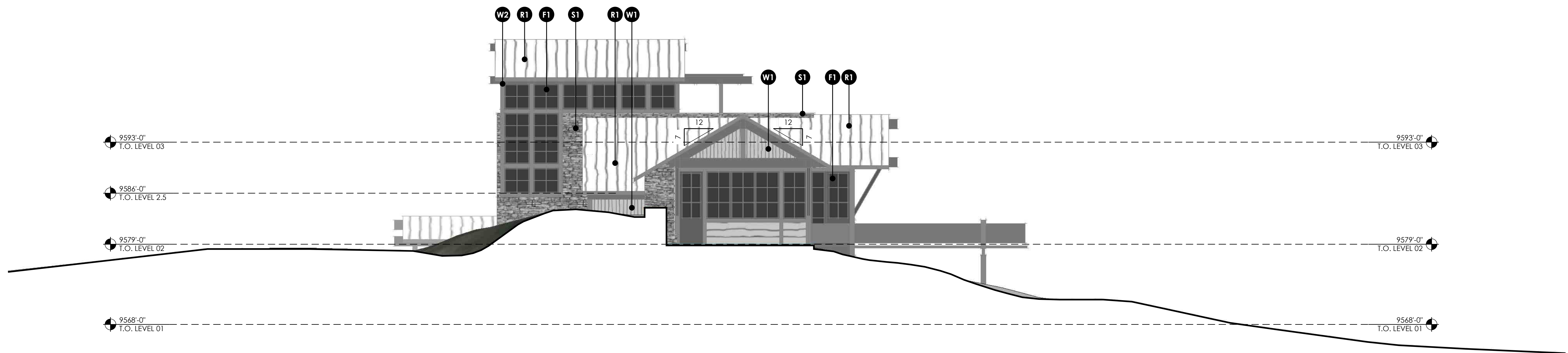

MATERIAL	AMOUNT IN SQ. FT.
STONE VENEER	464
WOOD & TIMBER SIDING	159
FENESTRATION	344
UPPER TERRACE HIDDEN	66
TRASH ENCLOSURE HIDDEN	27

2 SOUTH ELEVATION
SCALE: 1/8" = 1'-0"

The Refuge

LOT 434
TOUCHDOWN DR
MTN. VILLAGE
COLORADO

**COMPILED
NORTH &
SOUTH
ELEVATIONS**

A3.2

Tommy Hein
ARCHITECTS

Box 3327 108 S. Oak St. Penthouse
Telluride, Colorado 81435
970.728.1220 www.TommyHein.com

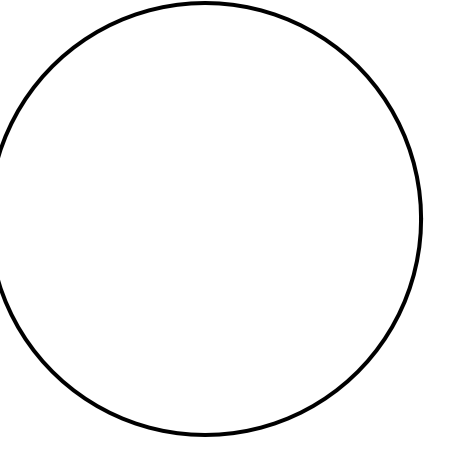

SUBMISSIONS

DATE:	SUBMISSION
09.22.2020	CLIENT MEETING
09.29.2020	CLIENT MEETING
10.16.2020	PLAN REVIEW
11.05.2020	DRB REVIEW
01.25.2021	CLIENT REVIEW
02.03.2021	DRB SKETCH REVIEW



The Refuge

LOT 434
TOUCHDOWN DR
MTN. VILLAGE
COLORADO

**EXTERIOR
PERSPECTIVE
VIEWS**

**A
3.3**



John A. Miller

From: Scott Heidergott <sheidergott@telluridefire.com>
Sent: Thursday, February 18, 2021 2:25 PM
To: John A. Miller
Subject: Re: Class 3 Referral - New Single Family Home @ 142 Touchdown Drive Lot 434

John,

Jim and I reviewed the plans and have some notes.

- 1) The livable space exceeds 3,600 sq ft, therefore it is required to have sprinklers throughout.
- 2) The suppression system shall be monitored.
- 3) The width of the driveway shall meet the code of 16' total width. 12' shall be a hard surface with the shoulders meeting the same compaction required as the hard surface and shall be an all weather driving surface. Just the drive up to the rotary.
- 4) The address monument shall be no less than 4'6" from the ground to the bottom of the address numbers. Address numbers shall be 6" in height, coated or outlined with coating

Kind regards

On Wed, Feb 17, 2021 at 4:37 PM John A. Miller <JohnMiller@mtnvillage.org> wrote:

Good Afternoon – attached you will find the plans for a Class 3 New single family home located at 142 Touchdown Drive.

https://townofmountainvillage.com/site/assets/files/34650/packet_for_referral_and_website.pdf

Please review and let me know if there are any issues or concerns.

Best,

J

John A Miller III

Senior Planner

Planning & Development Services