

**TOWN OF MOUNTAIN VILLAGE
SPECIAL DESIGN REVIEW BOARD MEETING
AGENDA**

THURSDAY JUNE 10, 2021 10:00 AM

MOUNTAIN VILLAGE TOWN HALL

455 MOUNTAIN VILLAGE BLVD, MOUNTAIN VILLAGE, COLORADO

TO BE HELD: <https://us02web.zoom.us/j/87580234046?pwd=VWE2eEhLaStCUk95UVBjTEc5ODhEQT09>

	Time	Min.	Presenter	Type	
1.	10:00	2	Chair		Call to Order
2.	10:02	3	Ward Applicant	Quasi-Judicial	Consideration of a Design Review: Initial Architecture and Site Review for a new Single Family Detached Condominium on Lot AR59, 129 Adams Way, pursuant to CDC Section 17.4.11. Staff is requesting that this item be continued to the July 1, 2021 Regular DRB Meeting.
3.	10:05	45	Miller Applicant	Quasi-Judicial	Consideration of a Design Review: Initial Architecture and Site Review for a new Single-Family home on Lot 226BR, 242 Benchmark Drive, pursuant to CDC Section 17.4.11. This item was continued from the 4.22.2021, and 6.3.2021 Regular Meeting.
4.	10:50	45	Miller Applicant	Quasi-Judicial	Consideration of a Design Review: Final Architectural Review for a new Single-Family residence on Lot 424, 121 Touchdown Drive, pursuant to CDC section 17.4.11. This item was continued from the 3.4.2021 Regular Meeting.
5.	11:35	45	Ward Applicant	Quasi-Judicial	Consideration of a Design Review: Initial Architecture and Site Review for a new Single-Family Home on Lot 214A, 209 Benchmark Drive, pursuant to CDC Section 17.4.11.
6.	12:20	45	Ward Applicant	Quasi-Judicial	Consideration of a Design Review: Initial Architecture and Site Review for a new Single Family Detached Condominium on Lot AR52R, 123 Adams Way, pursuant to CDC Section 17.4.11.
7.	1:05	45	Miller Applicant	Quasi-Judicial	Consideration of a Design Review: Initial Architecture and Site Review for a new Single-Family Home on Lot 510, 131 Russell Drive, pursuant to CDC Section 17.4.11.
8.	1:50		Chair		Adjourn

Join Zoom Meeting

<https://us02web.zoom.us/j/87580234046?pwd=VWE2eEhLaStCUk95UVBjTEc5ODhEQT09>

Meeting ID: 875 8023 4046

Passcode: 757374

One tap mobile

+1 346 248 7799 US

Please note that this Agenda is subject to change. (Times are approximate and subject to change)

455 Mountain Village Blvd., Suite A, Mountain Village, Colorado 81435

Phone: (970) 369-8242

Fax: (970) 728-4342

Individuals with disabilities needing auxiliary aid(s) may request assistance by contacting Town Hall at the above numbers or email: cd@mtnvillage.org. We would appreciate it if you would contact us at least 48 hours in advance of the scheduled event so arrangements can be made to locate requested auxiliary aid(s).



Agenda Item No. 2
**PLANNING AND DEVELOPMENT SERVICES
DEPARTMENT**

455 Mountain Village Blvd.
Mountain Village, CO 81435
(970) 369-8250

TO: Mountain Village Design Review Board

FROM: Amy Ward, Planner

FOR: Design Review Board Meeting; June 3, 2021

DATE: May 26, 2021

RE: Consideration of a Design Review: Initial Architecture and Site Review for a new Single-Family Detached Condominium on Lot AR59, 129 Adams Way, pursuant to CDC Section 17.4.11.

BACKGROUND: Staff is requesting a continuation of the Initial Architectural and Site Review to the July 1, 2021 Regular Meeting. The memo is being provided not to open the public hearing but solely for the purpose of the DRB providing a motion to continue to the Regular July 1 meeting date.

DRB also has the ability to table the item, which would require the applicant to re-notice the project at a time in the future.

RECOMMENDED MOTION: I move to continue, the consideration of a Design Review: Initial Architecture and Site Review for a new Single-Family home on Lot AR59, 129 Adams Way, pursuant to CDC Section 17.4.11.to the Regular Design Review Board Meeting on July 1, 2021.

/AW



TO: Mountain Village Design Review Board

FROM: John Miller, Senior Planner

FOR: Design Review Board Public Hearing; June 10, 2021

DATE: June 1, 2021

RE: Consideration of a Design Review: Initial Architecture and Site Review for a new Single-Family home on Lot 226BR, 242 Benchmark Drive, pursuant to CDC Section 17.4.11. (continued from April 22, 2021 and June 3, 2021)

Project Overview

PROJECT GEOGRAPHY

Legal Description: LOT 226-BR TMV ACC TO REPLAT OF LOTS 226A, 226B AND 404 REC 04 30 2010 IN PLAT BK 1 PG 4335-4336

Address: 242 Benchmark Drive
Applicant/Agent: Michael B. Donohue, Stillwater Architecture, LLC
Owner: JW Ranlan, LLC
Zoning: Single-Family
Existing Use: Vacant
Proposed Use: Single-Family
Lot Size: 0.60 Acres

Adjacent Land Uses:

- **North:** Single-Family
- **South:** Single-Family
- **East:** Single-Family
- **West:** Active OS

ATTACHMENTS

- Exhibit A: Application
- Exhibit B: Plan Set
- Exhibit C: Public / Referral Comments

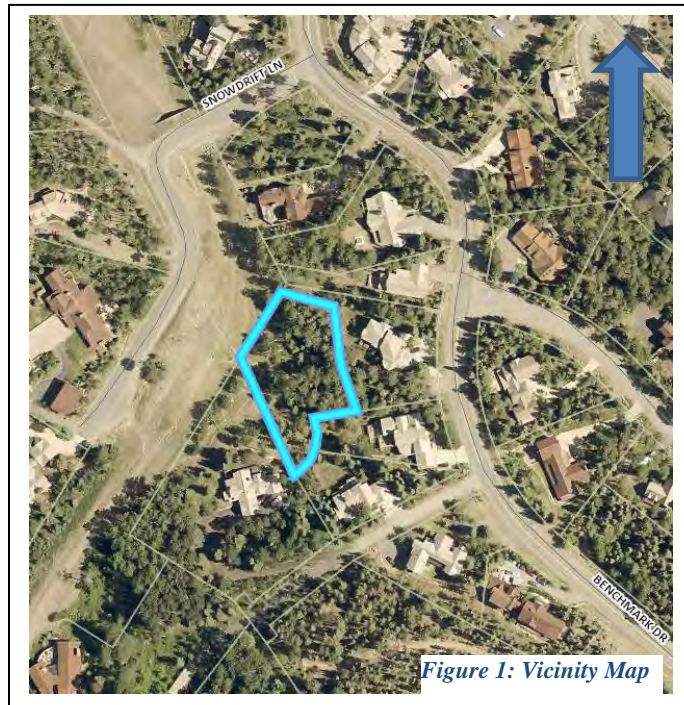

Figure 1: Vicinity Map

Case Summary: Michael B. Donohue of Stillwater Architecture (Applicant), working on behalf of JW RANLAN, LLC (Owner), is requesting Design Review Board (DRB) approval of an Initial Architectural and Site Review (IASR) Application for a new single-family home on Lot 226BR, 242 Benchmark Drive. The Lot is approximately 0.60 acres and is zoned Single-Family. The overall square footage of the home is approximately 6,321.55 gross square feet. The property is unique in that it does not have lot frontage on Benchmark Drive, and rather relies on an access easement crossing the southern General Easement (GE) of Lot 226AR. The lot is generally forested with a gentle slope, bordering the Galloping Goose Ski Run. At the April 22, 2021 Special DRB Meeting, the DRB continued this item in order for the applicant to make revisions to the driveway crossing the access easement – requesting that the retaining wall associated with the driveway be redesigned in such a way that reduces the impact to the neighboring homes. The applicant, working with the Fire Marshall, has revised the driveway in a way that meets access requirements for fire but also reduces the wall height as requested.

Applicable CDC Requirement Analysis: The applicable requirements cited may not be exhaustive or all-inclusive. The applicant is required to follow all requirements even if an applicable section of the CDC is not cited. ***Please note that Staff comments will be indicated by italicized Text.***

Table 1

CDC Provision	Requirement	Proposed
Maximum Building Height	35' (shed) Maximum	27'- 10 9/16"
Maximum Avg. Building Height	30' (shed) Maximum	24.89'
Maximum Lot Coverage	40% Maximum	18.9%
General Easement Setbacks	16' GE	Retaining wall encroachment
Roof Pitch		
Primary		1:12
Secondary		N/a
Exterior Material**		
Stone	35% minimum	33.53%
Windows/Doors	40% maximum	20.08%
Parking	2 enclosed / 2 surface	2/2

Design Review Board Design Variations

1. *Exterior Wall Materials – Stone Percentage*

Design Review Board Specific Approvals:

2. *General Easement Encroachment*

Chapter 17.3: ZONING AND LAND USE REGULATIONS

17.3.12: Building Height Limits

Sections 17.3.11 and 17.3.12 of the CDC provide the methods for measuring Building Height and Average Building Height, along with providing the height allowances for specific types of buildings based on their architectural form. The proposed design incorporates a 1:12 shed roof form. Homes with a primary shed roof form are granted a maximum building height of 35 feet. The maximum average height must be at or below 30 feet for shed roof forms. The average height is an average of measurements from a point halfway between the roof ridge and eave. The points are generally every 20 feet around the roof. The maximum height is measured from the highest point on a roof directly down to the existing grade or finished grade, whichever is more restrictive.

Staff: As part of this application, the applicant has provided both a Maximum Building Height and Average Building Height analysis. Based on the heights provided, the maximum building height just below 28 feet from the highest ridge to the grade below. The maximum average height is 24.89 feet. Both of these heights comply with the CDC requirements. Additionally, the applicant has provided a parallel plane analysis demonstrating that no portion of roof forms penetrates the 35-foot parallel slope height allowance. The limited height of this home at approx. 28 feet (-7ft) reduces the overall impacts to surrounding neighbors in comparison to a 40 foot gabled home.

17.3.14: General Easement Setbacks

Lot 226BR is burdened by a sixteen (16) foot General Easement (GE) which surrounds its perimeter with the exception of the northwest property line. The CDC provides that the GE and other setbacks be maintained in a natural, undisturbed state to provide buffering to surrounding land uses. The CDC does provide for some development activity within the GE and setbacks such as Ski Access, Natural Landscaping, Utilities, Address Monuments, and Fire Mitigation. All encroachments not listed above will require encroachment agreements between the property owner and the Town.

Staff: The proposal includes several GE encroachments that fall into the above category of permitted GE development activity including the following:

- *Driveway: The Driveway as shown currently takes access from the Benchmark Drive Right of Way (ROW) and traverses along a 25-foot access easement crossing Lot 226AR. Due to the grade of the site and the narrowness of the access easement, the driveway necessitates a retaining wall on either side that will also be located with the GE.*
- *Utilities: The majority of the utility connections are shown coming from Benchmark Drive, across the access easement for Lot 226AR and into Lot 226BR, with the exception of the Sewer service which is shown connecting into an existing main within the Galloping Goose Ski Run.*
- *Landscaping: The proposed landscaping is within the GE between Lots 226BR and 226AR. While natural landscaping is permitted, any associated irrigation must be approved by the DRB and any irrigation within the GE must be included in the GE Encroachment Agreement.*

Staff: The proposal also includes GE encroachments that fall into the category of GE development activity that requires DRB approval, including the following:

- *Rear Retaining Wall: The applicant has revised their plans since the April 22 meeting to remove the retaining wall to the rear of the home within the GE.*
- *Temporary Irrigation: The applicant has indicated that the landscaping surrounding the home will be irrigated on a temporary basis. Although temporary, this will require DRB approval.*

Chapter 17.5: DESIGN REGULATIONS

17.5.4: Town Design Theme

The Town of Mountain Village has established design themes aimed at creating a strong image and sense of place for the community. Due to the fragile high alpine environment, architecture and landscaping shall be respectful and responsive to the tradition of alpine design – reflecting elements of alpine regions while blending influences that visually tie the town to mountain buildings. The town recognizes that architecture will continue to evolve and create a regionally unique mountain vernacular, but these evolutions must continue to embrace nature and traditional style in a way that respects the design context of the neighborhoods surrounding the site.

Staff: The proposed home is very modern in form, incorporating reverse gabled style shed roofs, projecting at a 1:12 pitch in different directions. Although modern, the home does appear to blend with the existing design theme of the Mountain Village and especially the newer more modern homes. The design incorporates a material palette of what appears to be Telluride Goldstone, shiplap horizontal siding, and darker metal features such as windows and roofing.

Overall, it appears based on the applicant's submittal that the material palette for the project blends well with both the surrounding community, as well as the overall modern mountain vernacular. At the IASR, staff discussed the following items with the DRB:

- Architectural Grade Glue Lam Beams: The applicant has proposed Glue Lam beams accenting the home and particularly the porch areas. The DRB discussed this in April and expressed general comfort with the use of this material.*
- Contrast of Materials: The renderings have been slightly revised so that the home no longer presents so mono-chromatic. It appears that the renderings provided as part of the updated materials do not accurately capture the color of the wood stain shown in the material samples.*

17.5.5: Building Siting Design

The CDC requires that any proposed development blend into the existing landforms and vegetation.

Staff: The building siting for the proposed design is largely driven by the access easement for the site. Generally speaking, the site is relatively flat but the minor grade changes and the access easement development requirements do seem to necessitate somewhat of a driveway/parking pedestal that appears to stand out more than it would otherwise if the parking area was at or near existing grade. Visually, the impacts from this will be limited given the location of the Lot. It should be noted that this was discussed at the IASR, and the applicant did attempt to reduce the driveway retaining wall heights which further limit the appearance of the home siting on a plinth.

In terms of the project blending into the landscape and vegetation, the home is somewhat subdued in terms of height and massing, and staff does believe given the large amounts of existing vegetation surrounding the site that this home will be visually subordinate to its surroundings.

17.5.6: Building Design

Staff: The CDC requires that building form and exterior wall forms portray a mass that is thick and strong with a heavy grounded foundation. To accomplish this, the applicant is proposing what appears to be a Telluride gold stone in a random rectangular arrangement. The proposed siding and soffit materials are shiplap-stained siding 8" in width. In addition to the siding, a prominent element of the home is the Glu-Lam Beams described above. Based on the plans provided, the applicant is meeting all materials requirements for Stone and Glazing.

It should be noted that since the IASR in April, the applicant has revised the material calculations and the stone percentage now is just under the required 35%. This request will require the DRB to issue a design variation if they determine it to be appropriate. Staff does not recommend approval of the design variation at this time and instead recommend revising the plans prior to Final Review to increase the stone to the full required 35%

Window and door trim are proposed as black-clad wood windows, and the applicant has provided the preliminary window and door schedules, but more detail should be provided for the garage door materials before FAR. Any windows and or doors located within stone must be recessed per the CDC. The proposed roofing material is a black standing seam product, and the fascia of the home appears to the siding described above. The CDC allows for Black and Grey standing seam roofing materials and this appears to meet that requirement. It should be noted that the applicant has not shown snow fencing on the roof plan which is a requirement of the CDC but it's unclear to staff if this will be necessary given the slopes of the roof. Additionally, there is a chimney shown on the elevations and staff assumes this will necessitate a chimney cap, but this information has not been provided at this time.

Generally speaking, the applicant shall review the requirements of Section 17.5.6, and revise the plans to include all specific material details required prior to Final Architecture Review (FAR).

The civil drawings do show limited heated slabs with snowmelt, but the total square footage of this area has not been identified. Prior to FAR, the applicant shall revise these plans to detail areas of exterior snowmelt and the associated square footages.

17.5.7: Grading and Drainage Design

Staff: The applicant has provided a grading and drainage plan in accordance with the CDC requirements. The design of the home has enabled the project to minimize grading in most areas surrounding the home. The largest area of disturbance will be with the creation of the driveway but there will be minor grading occurring in areas around the rear of the home. The grading plan demonstrates final grades and that the home does generally have positive drainage.

17.5.8: Parking Regulations

Staff: The CDC requires all single-family developments to provide two interiors and two surface parking spaces. The applicant is currently meeting this requirement. Additionally, the applicant is meeting all other requirements of the CDC for parking.

17.5.9: Landscaping Regulations

The applicant has provided a preliminary landscaping plan for initial review. Generally speaking, staff does not oppose the proposed landscaping but has the following suggested revisions prior to final review:

1. *Due to the number of notes on the plan page A1.3, staff recommends separating the landscaping and fire mitigation plans into two separate documents.*
2. *Additional shrub plantings should be provided in addition to the trees identified.*
3. *The applicant could potentially work with neighboring owners to provide additional landscaping buffer along driveway retaining walls.*
4. *Native Seed Mix per the CDC requirements must be identified and any area of disturbance on the site must be identified for revegetation.*
5. *Existing trees on-site to remain shall be identified. If within proximity to construction, they should be protected, and the protection method should be detailed.*
6. *Irrigation notes related to flow usage, backflow preventor, etc. shall be added.*

17.5.11: Utilities

Staff: The majority of utilities are currently located within Benchmark Drive ROW and will only require connections from the road to the home. The exception to this is the Sanitary Sewer connection which will require a tie-in to the existing Sanitary Sewer main located in the Galloping Goose Ski Run. The applicant should work with TSG prior to the installation of this sewer connection. In addition, the applicant shall work with the Public Works Director before the issuance of a building permit to determine the specific locations of the connections for the home as these locations are conceptual only. It should be noted that the utility plan currently shows the utility meters in locations that appear to be screened.

17.5.12: Lighting Regulations

Staff: The applicant has not provided a lighting plan at this time but has provided some lighting information related to the specific fixtures that will be incorporated into a future plan. From these cut sheets, it appears that the LED strip light does not meet the CDC requirements for lumen output. The BLE fixture does appear to be able to be modifiable in a way that would meet the CDC requirements of lighting. Due to the size of the home, the applicant will be required to provide a photometric study. These items should be provided at Final per the requirements for submittal.

17.5.13: Sign Regulations

Staff: Due to the location of the home and the access easement across Lot 226AR, the address monument will need to be located off-site and adjacent to Benchmark Drive. The applicant has proposed a design for the address monument of a natural boulder with 6' metal black numbering. The address monument has been modified since the Initial Review to meet the requirements of the CDC. It may be preferable to shift the address monument slightly from the GE of Lot 226AR, into the Road ROW – this will require public works approval and the owner to enter into a RROW Encroachment Agreement with the Town for the monument.

Chapter 17.6: SUPPLEMENTARY REGULATIONS

17.6.1: Environmental Regulations

Staff: Fire Mitigation and Forestry Management: The applicants have provided a fire mitigation plan, but per the comments above within the Landscaping provisions, staff recommends that this plan be separated from the Landscaping Plan. Staff is also recommending that the owner work with the Town Forester to mark trees for removal on the site prior to the issuance of a building permit.

Steep Slopes: The building site does not contain steep slopes.

17.6.6: Roads and Driveway Standards

Staff: The civil plans provided indicate that the driveway from the edge of road pavement to the garage is approximately 226 feet. With that, the CDC requires a 16-foot paved surface. In order to accomplish this, the applicant has provided for 14 feet of asphalt, with an additional 2-foot concrete v-pan for drainage.

In the IASR in April, a number of concerns were raised by the neighbors related to the height of the retaining walls associated with the driveway. In order to mitigate these concerns, the applicant has reduced the overall heights of these walls with the majority of these walls at 1-3 feet in height. Currently, these walls are shown as concrete, but staff did want to discuss the following options for these walls as retaining walls are required to be faced.

- 1. Face the concrete wall with rusted metal or stone product.*
- 2. Request board form concrete specific approval from the DRB for the wall.*

Staff would like to better understand the DRB and applicants comfort with these options.

In addition, because of the retaining wall changes, the grade of the driveway was required to become steeper. Because of the size of the home, sprinklers are required, and the sprinkler system allows the driveway to be permitted as shown with a maximum grade of 11.90%.

17.6.8: Solid Fuel Burning Device Regulations

Staff: The applicant has indicated that the proposed home does include fireplaces and unless the owners procure a fireplace permit, these must operate on natural gas. Prior to Final Review, these plans should be revised to explicitly state that they are natural gas burning fireplaces.

Chapter 17.7: BUILDING REGULATIONS

17.7.19: Construction Mitigation

Staff: The applicant has submitted a construction mitigation plan in accordance with the requirements of the CDC. Given the extensive driveway construction that will be required to access the site, the applicant is requesting on-street parking for the initial portion of the project. It's unclear if the project will require a crane at this time. Generally speaking, the applicant is meeting the requirements of the stormwater mitigation and fencing. It will be very important to limit impacts of construction within the access easement given the proximity of neighbors. Staff is recommending that the applicant work through these details with the neighbors prior to construction.

Staff Recommendation: Staff recommends the DRB approve the Initial Architectural and Site Review for Lot 226BR, 242 Benchmark Drive.

Staff Note: *It should be noted that reasons for approval or rejection should be stated in the findings of fact and motion.*

Proposed Motion:

If the DRB deems this application to be appropriate for approval, Staff requests said approval condition the items listed below in the suggested motion.

I move to approve the Initial Architectural and Site Review for a new single-family home located at Lot 226BR, 242 Benchmark Drive, based on the evidence provided within the

Staff Report of record dated June 1, 2021, with the following and Design Variations and Specific Approvals:

Design Review Board Design Variation

- 1) *Exterior Wall Materials – Stone Percentage (not recommended by staff)*

Design Review Board Specific Approvals:

- 1) *General Easement Encroachment - Irrigation*

And, with the following conditions:

- 1) Prior to submittal for a Final Architectural Review, the applicant shall revise material calculations to increase the stone percentage to 35% minimum.
- 2) Prior to submittal for a Final Architectural Review, the applicant shall revise plans so that any area of fenestration within the stone façade shall be recessed and the recessed detail provided. Other proposed materials shall be updated to include specific details on the chimney cap, stone type, stain type, etc.
- 3) Prior to submittal for a Final Architectural Review, the applicant shall provide area calculations for snowmelt.
- 4) Prior to submittal for a Final Architectural Review, the applicant shall revise the landscaping and fire mitigation plan based on the comments within this report.
- 5) Prior to submittal for a Final Architectural Review, the applicant shall revise the location of the address monument so that it is within the RROW rather than Lot 226AR, or otherwise provide documentation that the access easement permits the construction of an address monument.
- 6) Prior to the submittal for a Final Architectural Review, the applicant shall provide a revised lighting plan, to include locations, fixture types, and cut sheets, as well as a photometric study of the home.
- 7) Prior to the issuance of a building permit, the applicant shall field verify all utilities and submit a revised utility plan to the public works director identifying the location of utilities and connection points.
- 8) Consistent with town building codes, Unenclosed accessory structures attached to buildings with habitable spaces and projections, such as decks, shall be constructed as either non-combustible, heavy timber, or exterior grade ignition resistant materials such as those listed as WUIC (Wildland Urban Interface Code) approved products.
- 9) Prior to issuance of a CO, the property owner will enter into a General Easement Encroachment Agreement, as applicable, with the Town of Mountain Village for the general easement encroachments approved.
- 10) A monumented land survey shall be prepared by a Colorado public land surveyor to establish the maximum building height and the maximum average building height.
- 11) A monumented land survey of the footers will be provided prior to pouring concrete to determine there are no additional encroachments into the GE.
- 12) Prior to the Building Division conducting the required framing inspection, a four-foot (4') by eight-foot (8') materials board will be erected on site consistent with the review authority approval to show:
 - a. The stone, setting pattern, and any grouting with the minimum size of four feet (4') by four feet (4');
 - b. Wood that is stained in the approved color(s);
 - c. Any approved metal exterior material;
 - d. Roofing material(s); and
 - e. Any other approved exterior materials.

13) It is incumbent upon an owner to understand whether above grade utilities and town infrastructure (fire hydrants, electric utility boxes) whether placed in the right of way or general easement, are placed in an area that may encumber access to their lot. Relocation of such above grade infrastructure appurtenances will occur at the owner's sole expense and in coordination with the appropriate entity (fire department, SMPA, Town of Mountain Village) so that the relocated position is satisfactory.

/jjm

Lot 226BR Project Narrative

General Description:

The project consists of an approximate 5200 square foot home in what we refer to as “Mountain Modern,” using natural materials in a more contemporary form. As currently proposed, the home is a two-story residence, including a walk out basement; the building height is an average of 24.89 feet above the most restrictive grade, and at the highest point is 28.00 feet above grade (7 feet under the allowable building height) to minimize impact on views for the surrounding properties.

The easement allowed for entrance to the property requires that the driveway be built up in order to meet the minimum requirements of driveway and fire protection services access. We have intentionally limited this as much as possible, again, to minimize the impact on views for the surrounding properties.

Materials:

Materials consist of Veneer Stone, Cedar Siding, Glue-Laminated Beams, Metal Roofing, Painted Metal Railings, Clad Wood Windows, and Expanded Metal Grating for stairs. Sheet AO.2 provides exterior perspectives and pictures of materials proposed for this project, all of which comply with the Mountain Village Design Guidelines.

Special Requests:

1. Drawing C2 shows a “dry stack wall to divert existing swale” and we respectfully request to remove that wall, and divert the runoff water through Lot 404-A. We are requesting this for the following reasons:
 - a. Lot 226BR and Lot 404-A are owned by the same owners, and;
 - b. Diverting the natural runoff through an existing swale requires less architectural and environmental impact on the property, and;
 - c. The construction of the dry stack wall would require a variance by itself.
2. Drawing C2 shows a driveway retaining wall 5'-0" high and we respectfully request a Design Variation from the maximum 4'-0" stepped wall requirement.
 - a. In order to meet the required fire protection width and grading for the driveway, the retaining wall separation distance do not allow us to step the wall as required in the design guidelines.
 - b. We have minimized the height of the wall to the maximum extent possible given the restraints.

If there are any questions, please do not hesitate to reach out.

Stillwater Architecture, LLC

Michael B. Donohue
312-655-0940

1657 N. Rockwell
Chicago, IL 60647

25 Lone Mountain Trail
Big Sky, MT 59716

P.O. Box 1742
Boulder, CO 80306

mdonohue@stillwaterarchitecture.com
www.stillwaterarchitecture.com

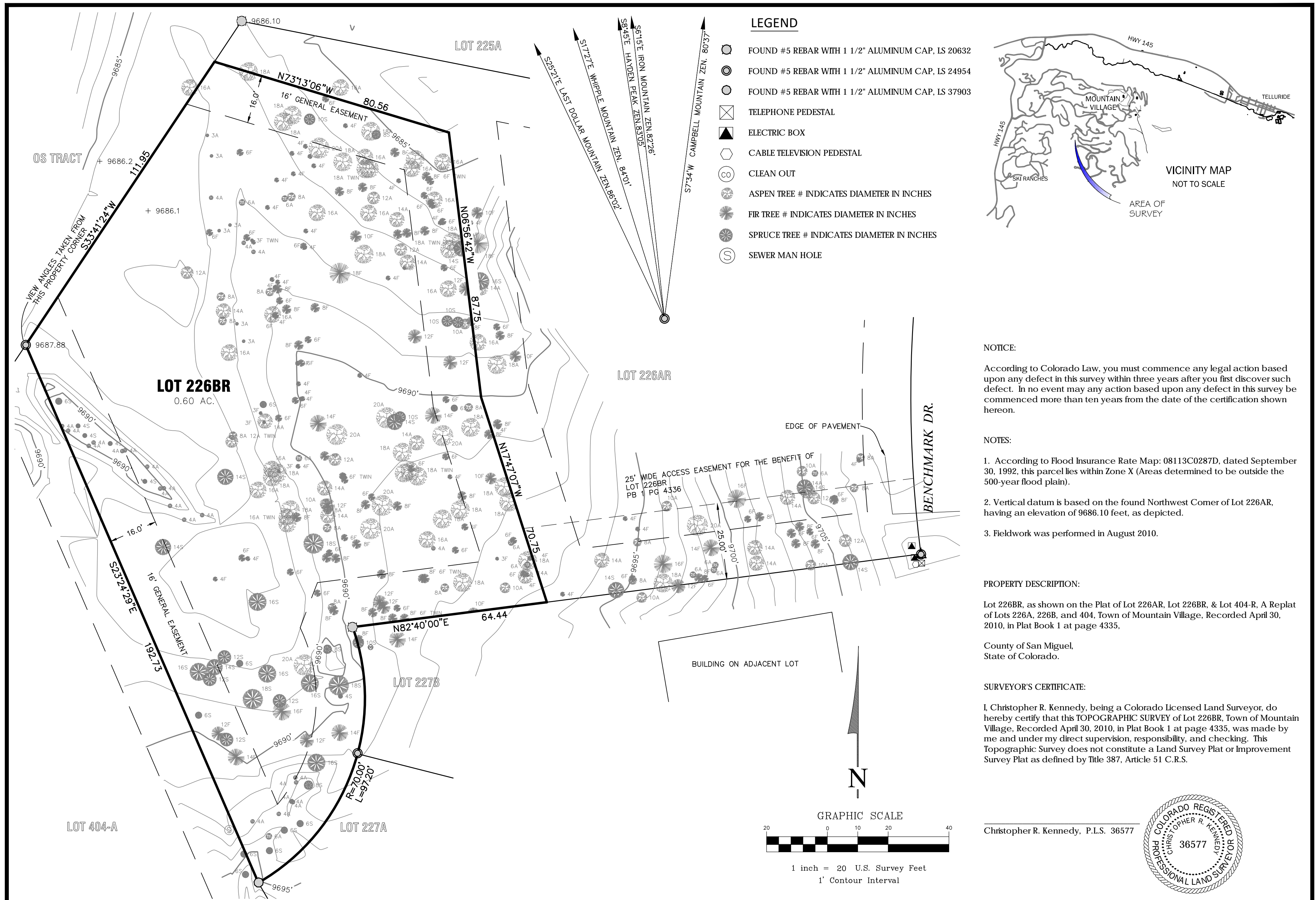

- LEGEND**
- FOUND #5 REBAR WITH 1 1/2" ALUMINUM CAP, LS 20632
 - FOUND #5 REBAR WITH 1 1/2" ALUMINUM CAP, LS 24954
 - FOUND #5 REBAR WITH 1 1/2" ALUMINUM CAP, LS 37903
 - ⊗ TELEPHONE PEDESTAL
 - ⬮ ELECTRIC BOX
 - CABLE TELEVISION PEDESTAL
 - CLEAN OUT
 - ASPEN TREE # INDICATES DIAMETER IN INCHES
 - FIR TREE # INDICATES DIAMETER IN INCHES
 - SPRUCE TREE # INDICATES DIAMETER IN INCHES
 - S SEWER MAN HOLE

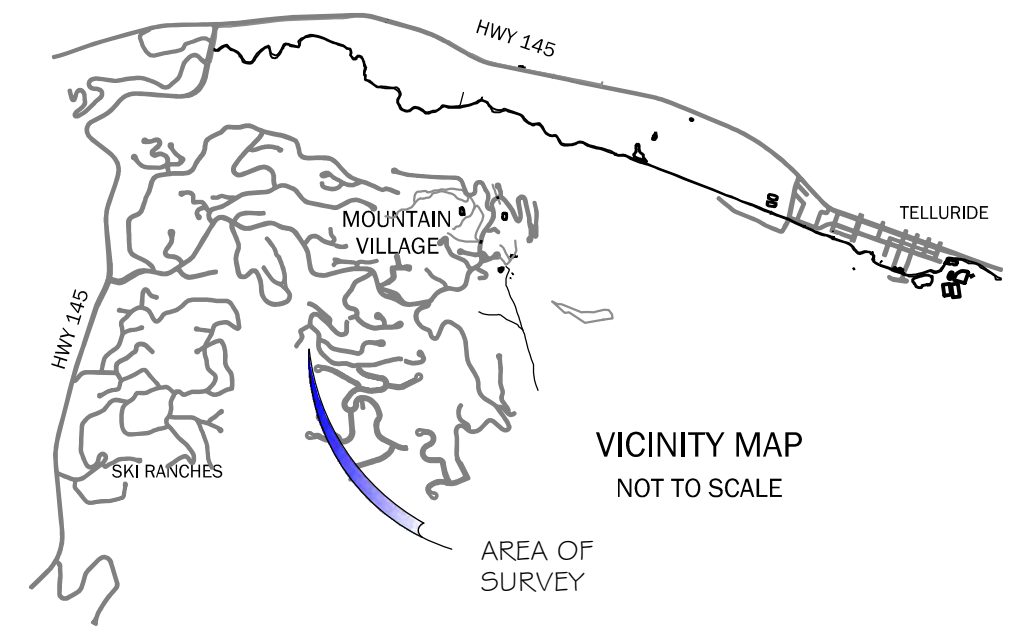

NOTICE:

According to Colorado Law, you must commence any legal action based upon any defect in this survey within three years after you first discover such defect. In no event may any action based upon any defect in this survey be commenced more than ten years from the date of the certification shown hereon.

NOTES:

1. According to Flood Insurance Rate Map: 08113C0287D, dated September 30, 1992, this parcel lies within Zone X (Areas determined to be outside the 500-year flood plain).
2. Vertical datum is based on the found Northwest Corner of Lot 226AR, having an elevation of 9686.10 feet, as depicted.
3. Fieldwork was performed in August 2010.

PROPERTY DESCRIPTION:

Lot 226BR, as shown on the Plat of Lot 226AR, Lot 226BR, & Lot 404-R, A Replat of Lots 226A, 226B, and 404, Town of Mountain Village, Recorded April 30, 2010, in Plat Book 1 at page 4335.

County of San Miguel,
State of Colorado.

SURVEYOR'S CERTIFICATE:

I, Christopher R. Kennedy, being a Colorado Licensed Land Surveyor, do hereby certify that this TOPOGRAPHIC SURVEY of Lot 226BR, Town of Mountain Village, Recorded April 30, 2010, in Plat Book 1 at page 4335, was made by me and under my direct supervision, responsibility, and checking. This Topographic Survey does not constitute a Land Survey Plat or Improvement Survey Plat as defined by Title 387, Article 51 C.R.S.

Christopher R. Kennedy, P.L.S. 36577

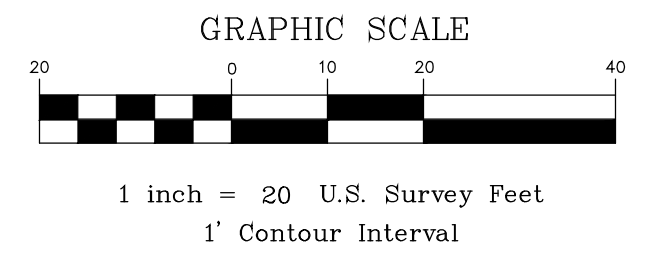

TOPOGRAPHIC SURVEY
LOT 226BR, TOWN OF MOUNTAIN VILLAGE

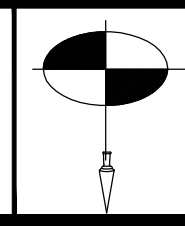

SAN JUAN SURVEYING
SURVEYING * PLANNING
160 D SOCIETY DRIVE TELLURIDE, CO. 81435
(970) 728 - 1128 (970) 728 - 9201 fax
office@sanjuansurveying.net

DATE:	08/18/10
JOB:	98002
DRAWN BY:	TAC
CHECKED BY:	CRK
REVISION DATES:	
SHEET:	1 OF 1

GENERAL CIVIL ENGINEERING NOTES:

1. THE EXISTING UTILITY LINES SHOWN ON THE PLANS ARE APPROXIMATE. AT LEAST TWO (2) FULL WORKING DAYS PRIOR TO COMMENCING CONSTRUCTION, THE CONTRACTOR SHALL CONTACT THE UTILITY NOTIFICATION CENTER OF COLORADO @ 1-800-922-1987 OR 811 TO GET ALL UTILITIES LOCATED. IF ANY OF THESE UNDERGROUND UTILITIES ARE IN CONFLICT WITH THE CONSTRUCTION PLANS, THE CONTRACTOR SHALL NOTIFY THE ENGINEER AND WORK WITH THE ENGINEER TO FIND A SOLUTION BEFORE THE START OF CONSTRUCTION.

INSTALLATION AND SEPARATION REQUIREMENTS SHALL BE COORDINATED WITH THE INDIVIDUAL UTILITY PROVIDERS.

THE UTILITY PROVIDERS ARE:
SEWER, WATER, CABLE TV AND FIBEROPTIC: TOWN OF MOUNTAIN VILLAGE
NATURAL GAS: BLACK HILLS ENERGY
POWER: SAN MIGUEL POWER
TELEPHONE: CENTURY LINK

2. PRIOR TO BEGINNING ANY CONSTRUCTION ACTIVITIES, ALL NECESSARY PERMITS SHALL BE OBTAINED BY THE OWNER OR CONTRACTOR.

3. IT IS THE CONTRACTOR'S RESPONSIBILITY TO INSURE THAT EXCAVATED SLOPES ARE SAFE AND COMPLY WITH OSHA REQUIREMENTS. REFER TO THE SITE-SPECIFIC REPORT FOR THIS PROJECT FOR ADDITIONAL INFORMATION..

4. ALL TRENCHES SHALL BE ADEQUATELY SUPPORTED OR LAID BACK PER OSHA REGULATIONS.

5. ALL MATERIALS AND CONSTRUCTION SHALL BE IN CONFORMANCE WITH THE TOWN OF MOUNTAIN VILLAGE DESIGN STANDARDS LATEST EDITION. ALL CONSTRUCTION WITHIN EXISTING STREET OR ALLEY RIGHT-OF-WAY SHALL BE SUBJECT TO TOWN OF MOUNTAIN VILLAGE INSPECTION.

6. THE CONTRACTOR SHALL HAVE ONE COPY OF THE STAMPED PLANS ON THE JOB SITE AT ALL TIMES.

7. THE CONTRACTOR SHALL NOTIFY THE TOWN 48 HOURS PRIOR TO THE START OF CONSTRUCTION.

8. THE CONTRACTOR IS RESPONSIBLE FOR IMPLEMENTING AND MAINTAINING EROSION AND SEDIMENT CONTROL MEASURES AT ALL TIMES DURING CONSTRUCTION. THE ADJOINING ROADWAYS SHALL BE FREE OF DEBRIS AT THE END OF CONSTRUCTION ACTIVITIES EACH DAY.

9. THE CONTRACTOR SHALL PROVIDE, ERECT AND MAINTAIN PROPER TRAFFIC CONTROL DEVICES UNTIL THE SITE IS OPEN TO TRAFFIC. ANY TRAFFIC CLOSURES MUST BE COORDINATED WITH THE TOWN OF MOUNTAIN VILLAGE.

10. ALL DAMAGE TO PUBLIC STREETS AND ROADS, INCLUDING HAUL ROUTES, TRAILS, OR STREET IMPROVEMENTS, OR TO PRIVATE PROPERTY, SHALL BE REPAIRED AT THE SOLE EXPENSE OF THE CONTRACTOR TO THE ORIGINAL CONDITIONS.

11. WHEN AN EXISTING ASPHALT STREET IS CUT, THE STREET MUST BE RESTORED TO A CONDITION EQUAL TO OR BETTER THAN ITS ORIGINAL CONDITION. THE FINISHED PATCH SHALL BLEND SMOOTHLY INTO THE EXISTING SURFACE. ALL LARGE PATCHES SHALL BE PAVED WITH AN ASPHALT LAY-DOWN MACHINE.

12. IF DEWATERING IS REQUIRED, THE CONTRACTOR SHALL NOTIFY THE ENGINEER. ANY DISCHARGE REQUIREMENTS SHALL BE COORDINATED WITH THE TOWN OF MOUNTAIN VILLAGE.

13. CONTRACTOR SHALL NOTIFY ALL RESIDENTS IN WRITING 24 HOURS PRIOR TO ANY SHUT-OFF IN SERVICE. THE NOTICES MUST HAVE CONTRACTOR'S PHONE NUMBER AND NAME OF CONTACT PERSON, AND EMERGENCY PHONE NUMBER FOR AFTER HOURS CALLS. ALL SHUT-OFF'S MUST BE APPROVED BY THE TOWN AND TOWN VALVES AND APPURTENANCES SHALL BE OPERATED BY TOWN PERSONNEL.

14. CONTRACTOR SHALL KEEP SITE CLEAN AND LITTER FREE (INCLUDING CIGARETTE BUTTS) BY PROVIDING A CONSTRUCTION DEBRIS TRASH CONTAINER AND A BEAR-PROOF POLY-CART TRASH CONTAINER, WHICH IS TO BE LOCKED AT ALL TIMES.

15. CONTRACTOR MUST BE AWARE OF ALL TREES TO REMAIN PER THE DESIGN AND APPROVAL PROCESS AND PROTECT THEM ACCORDINGLY.

16. THE CONTRACTOR SHALL PROVIDE UNDERGROUND UTILITY AS-BUILTS TO THE TOWN.

17. ALL STRUCTURAL FILL UNDER HARDSCAPE OR ROADS MUST BE COMPACTED TO 95% MODIFIED PROCTOR (MIN.) AT PLUS OR MINUS 2% OF THE OPTIMUM MOISTURE CONTENT. NON-STRUCTURAL FILL SHALL BE PLACED AT 90% (MIN.) MODIFIED PROCTOR.

18. UNSUITABLE MATERIAL SHALL BE REMOVED AS REQUIRED BY THE SOILS ENGINEER. ALL MATERIALS SUCH AS LUMBER, LOGS, BRUSH, TOPSOIL OR ORGANIC MATERIALS OR RUBBISH SHALL BE REMOVED FROM ALL AREAS TO RECEIVE COMPACTED FILL.

19. NO MATERIAL SHALL BE COMPACTED WHEN FROZEN.

20. NATIVE TOPSOIL SHALL BE STOCKPILED TO THE EXTENT FEASIBLE ON THE SITE FOR USE ON AREAS TO BE REVEGETATED.

21. THE CONTRACTOR SHALL BE RESPONSIBLE FOR DUST ABATEMENT AND EROSION CONTROL MEASURES DEEMED NECESSARY BY THE TOWN, IF CONDITIONS WARRANT THEM.

22. ALL DISTURBED GROUND SHALL BE RE-SEEDED WITH A TOWN-APPROVED SEED MIX. REFER TO THE LANDSCAPE PLAN.

23. THE CONTRACTOR IS REQUIRED TO PROTECT ALL EXISTING SURVEY MONUMENTS AND PROPERTY CORNERS DURING GRADING AND CONSTRUCTION.

24. ALL UNDERGROUND PIPE SHALL BE PROTECTED WITH BEDDING TO PROTECT THE PIPE FROM BEING DAMAGED.

25. HOT TUBS SHALL DRAIN TO THE SANITARY SEWER (OR PUMPED TO AA CLEAN-OUT).

26. THE UTILITY PLAN DEPICTS FINAL UTILITY LOCATIONS BUT HAS BEEN COMPLETED AT A PRELIMINARY STAGE. CONTRACTOR SHALL VERIFY ALIGNMENTS WITH THE ARCHITECT PRIOR TO CONSTRUCTION.

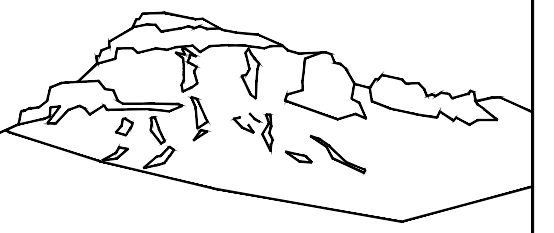

Uncompahgre
Engineering, LLC

P.O. Box 3945
Telluride, CO 81435
970-729-0683

SUBMISSIONS:

DRB 2020-07-25

Revised Driveway
through Easement 2021-05-25

Rante Residence
Lot 226BR
Benchmark Dr.
Mtn. Village



CONTRACTOR TO REVIEW AND COMPARE ALL CHAPTERS AND INTERDISCIPLINARY DRAWINGS AND REPORT ANY DISCREPANCIES TO THE ARCHITECT PRIOR TO ANY FIELD WORK BEING DONE IN ACCORDANCE WITH AIA DOCUMENT A201

Notes

C1

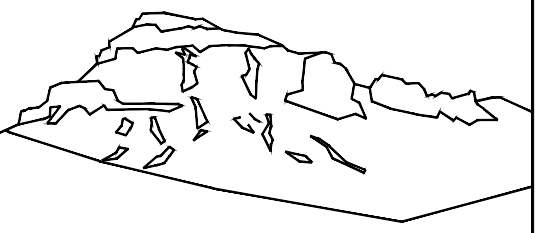

Uncompahgre Engineering, LLC

P.O. Box 3945
Telluride, CO 81435
970-729-0683

SUBMISSIONS:
DRB 2020-07-25
Revised Driveway through Easement 2021-05-25

Rante Residence
Lot 226BR
Benchmark Dr.
Mtn. Village



CONTRACTOR TO REVIEW AND COMPARE ALL CHAPTERS AND INTERDISCIPLINARY DRAWINGS AND REPORT ANY DISCREPANCIES TO THE ARCHITECT PRIOR TO ANY FIELD WORK BEING DONE IN ACCORDANCE WITH AIA DOCUMENT A201

Grading and Drainage with Driveway Plan and Profile
No Trees

C2.1

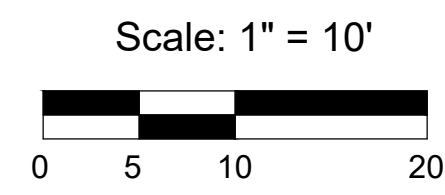
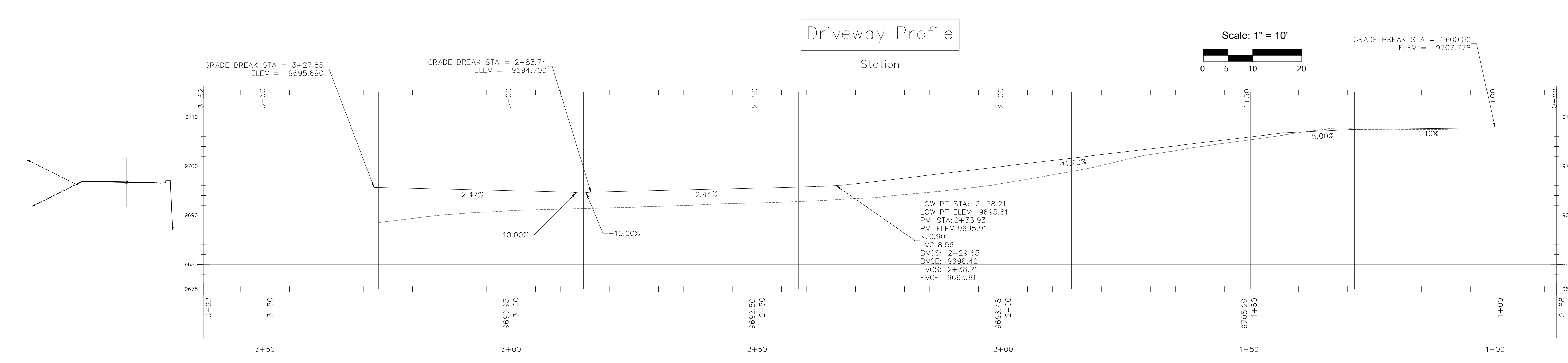
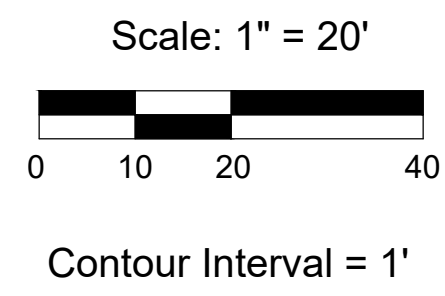
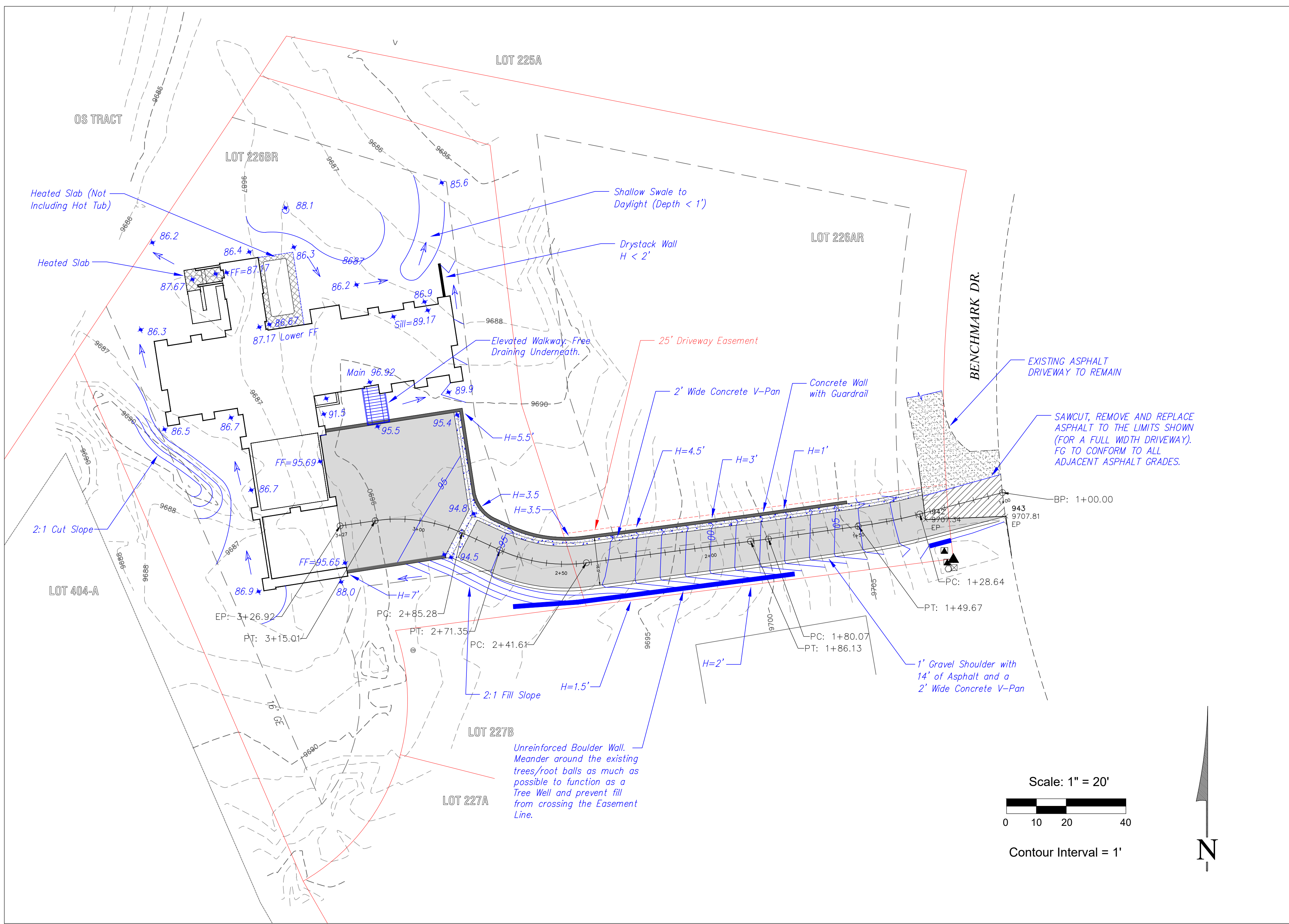

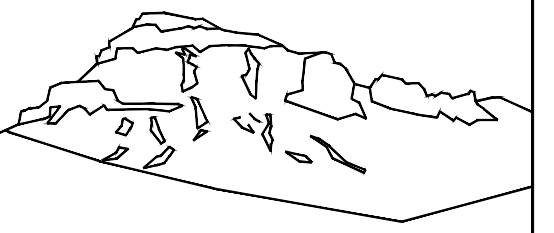

Uncompahgre Engineering, LLC

P.O. Box 3945
Telluride, CO 81435
970-729-0683

SUBMISSIONS:

DRB 2020-07-25
Revised Driveway through Easement 2021-05-25

Rante Residence
Lot 226BR
Benchmark Dr.
Mtn. Village



CONTRACTOR TO REVIEW AND COMPARE ALL CHAPTERS AND INTERDISCIPLINARY DRAWINGS AND REPORT ANY DISCREPANCIES TO THE ARCHITECT PRIOR TO ANY FIELD WORK BEING DONE IN ACCORDANCE WITH AIA DOCUMENT A201

Grading and Drainage with Driveway Plan and Profile with Trees

C2.5

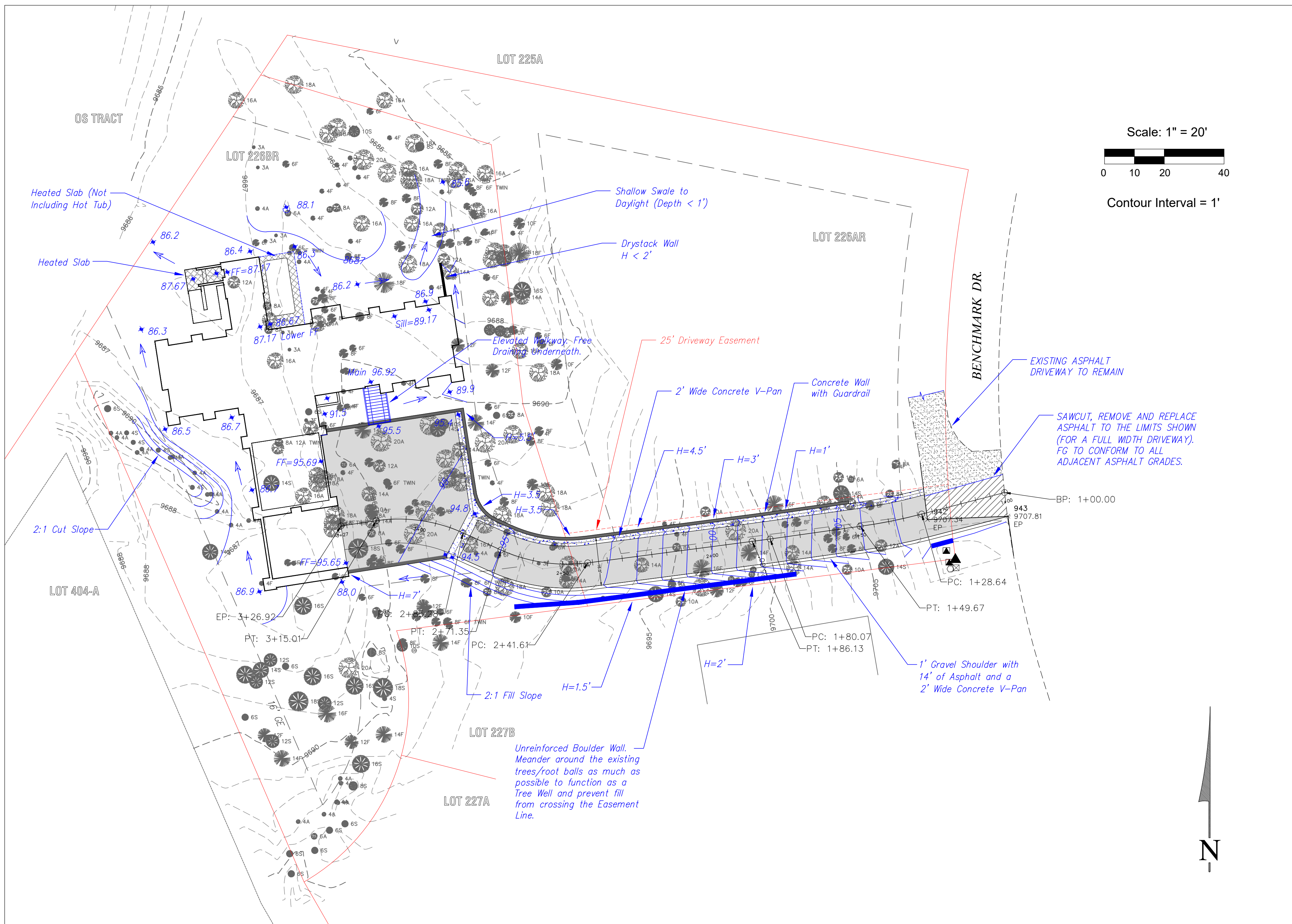

Scale: 1" = 20'
0 10 20 40
Contour Interval = 1'

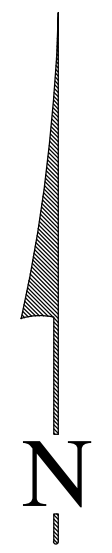

Driveway Profile

Station

Scale: 1" = 10'
0 5 10 20

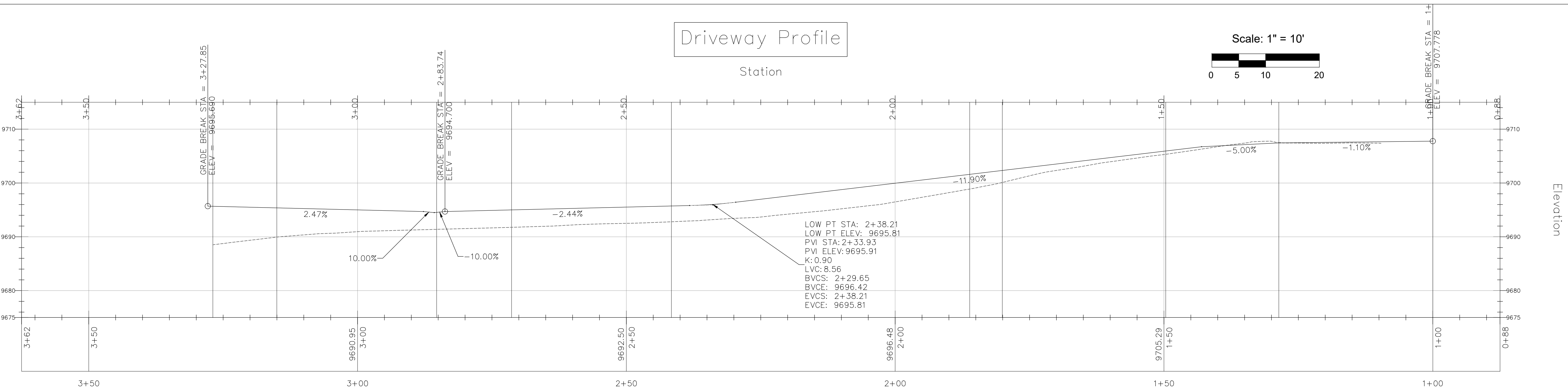

Elevation

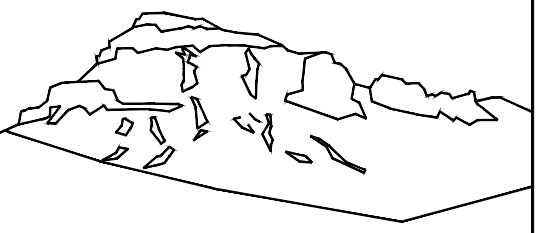

Uncompahgre Engineering, LLC

P.O. Box 3945
Telluride, CO 81435
970-729-0683

SUBMISSIONS:

DRB	2020-07-25
Revised Driveway through Easement	2021-05-25

Rante Residence
Lot 226BR
Benchmark Dr.
Mtn. Village



CONTRACTOR TO REVIEW AND COMPARE ALL CHAPTERS AND INTERDISCIPLINARY DRAWINGS AND REPORT ANY DISCREPANCIES TO THE ARCHITECT PRIOR TO ANY FIELD WORK BEING DONE IN ACCORDANCE WITH AIA DOCUMENT A201

Utilities

C3

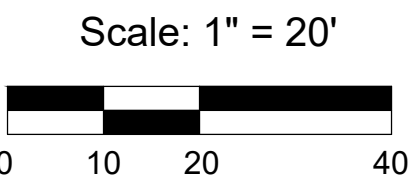
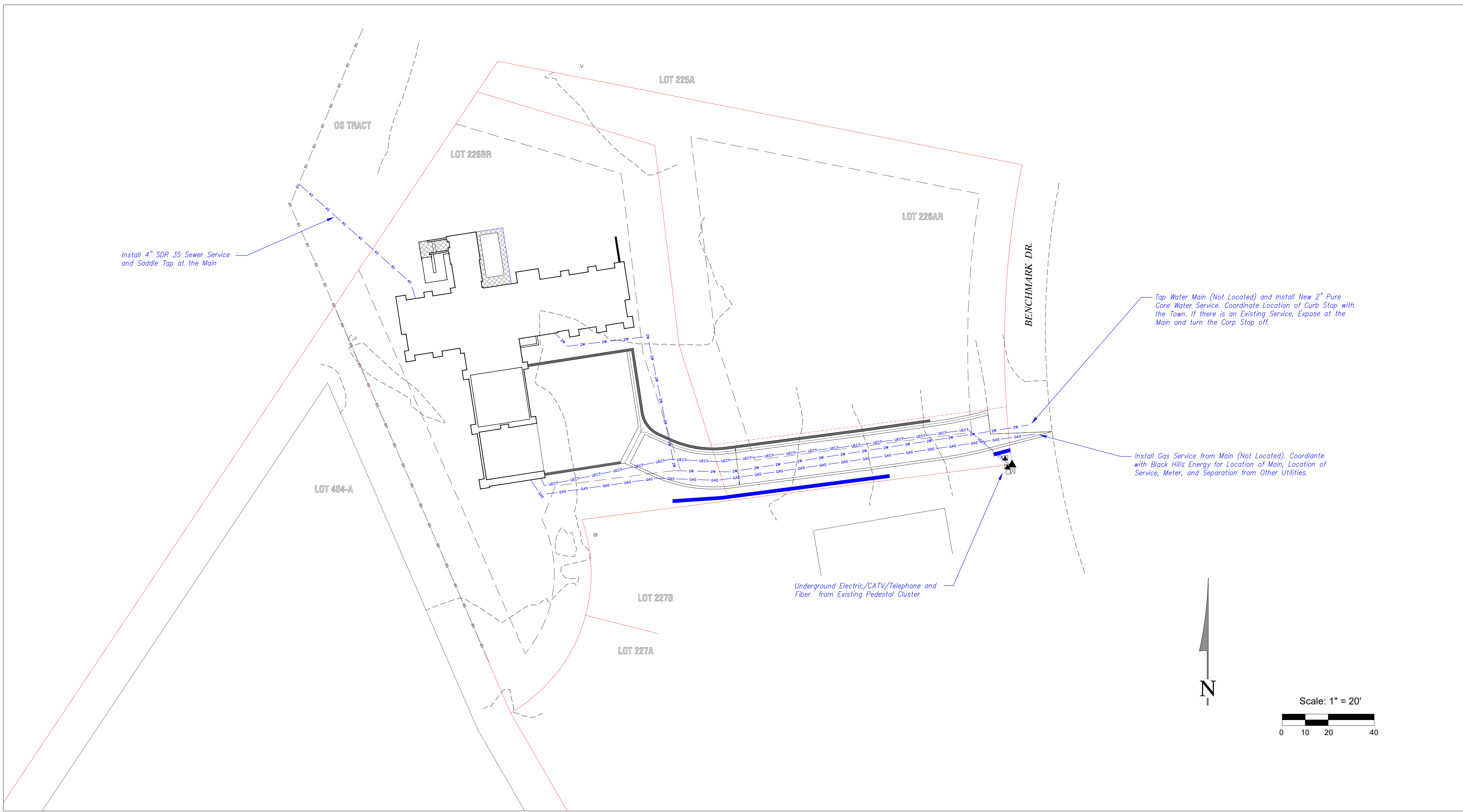

PROPOSED DEVELOPMENT CONDITIONS	
LOT AREA	25,961 SQ. FT.
ZONING	SINGLE FAMILY RESIDENTIAL
PARKING	(2) ENCLOSED SPACES, (2) EXTERIOR SPACES
FLOOR AREA	25,961 SQ. FT. (GROSS CONDITIONED/GARAGE/COVERED PARKING/PATIOS/DECKS SQUARE FOOTAGE)
LOT COVERAGE	4916.8 SQ. FT. (18.9%) (DOES NOT INCLUDE DRIVEWAY OR APRON)
BLDG. HT.	29'-6" (32'-4" AT T/ CHIMNEY)
	GROSS SQUARE FOOTAGES (INCLUDES ALL CONDITIONED SPACE, GARAGE, 4 BUTTRESSED STONE DETAILS)
LOWER LEVEL	3,261.11 SQ. FT.
MAIN LEVEL	3,059.84 SQ. FT.
TOTAL	6,321.55 SQ. FT.
AREA CALC'S	
	CONDITIONED SPACE
MAIN LEVEL	2,486.83 SQ. FT.
LOWER LEVEL	2,951.23 SQ. FT.
TOTAL	5,438.06 SQ. FT.
	EXTERIOR PATIOS & DECKS
MAIN LEVEL	815.41 SQ. FT.
LOWER LEVEL	341.13 SQ. FT.
TOTAL	1,162.60 SQ. FT.
	GARAGE AND COVERED PARKING
GARAGE	513.01 SQ. FT.
COV'd PRKG.	548.88 SQ. FT.
	SNOW MELT AREAS
WINDOW WELL	82.33 SQ. FT.
PATIOS	347.13 SQ. FT.
MST. DECKS	130.81 SQ. FT.
TOTAL	560.27 SQ. FT.
MATERIALS	
WINDOWS	1098.20 SQ. FT. / 19.64%
STONE	1951.30 SQ. FT. / 35.00% (DOES NOT INCLUDE DRIVEWAY)
WOOD	2098.90 SQ. FT. / 31.54%
METAL	431.39 SQ. FT. / 1.82%
TOTAL	5591 SQ. FT. / 100%

PROJECT TEAM	
OWNER	
JOHN, KELLY, & WILLIAM RANTE	
6500 S. ELM STREET	
BURR RIDGE, IL	
ARCHITECT	
STILLWATER ARCHITECTURE, LLC	
1657 N. ROCKWELL	
CHICAGO, IL 60647	
312-655-0940	
www.stillwaterarchitecture.com	
mdonohue@stillwaterarchitecture.com	
CIVIL ENGINEER	
UNCOMPAGRE ENGINEERING, LLC	
DAVID BALLODE	
P.O. BOX 3945	
TELLURIDE, CO 81435	
970-729-0683	
dbalode@men.com	
LIGHTING CONSULTANT	
LUMINOSITY	
CRAIG SPRING	
618 MOUNTAIN VILLAGE BLVD., SUITE 203A	
MOUNTAIN VILLAGE, CO 81435	
970.729.8892	
craig@luminosityald.com	
STRUCTURAL ENGINEER	
WAATTI ENGINEERING	
LEVI COUGHLIN	
2066 STADIUM DRIVE, SUITE 103	
BOZEMAN, MT 59715	
406.414.0220	
levi@waattiengineering.com	
HERS. CONSULTANT	
TO BE DETERMINED	

RELEVANT CODES		
YEAR	CODE	NOTES
2012	INTERNATIONAL RESIDENTIAL CODE	
2012	INTERNATIONAL ENERGY CODE	

VICINITY MAP	
LOT NUMBER	
LOT 226BR	
ADDRESS	
242 BENCHMARK DRIVE	
MOUNTAIN VILLAGE, CO 81435	



INDEX OF DRAWINGS		
DRB - SUBMITTAL I		
GENERAL INFORMATION		
A0	1	INDEX OF DRAWINGS / VICINITY MAP / RELEVANT CODES
	2	MATERIAL USAGE
SITE		
	1	ARCHITECTURAL SITE PLAN
	2	TOPOGRAPHIC SURVEY
	3	LANDSCAPE PLAN
	4	CONSTRUCTION STAGING PLAN
PLANS		
	0	LOWER LEVEL & ENTRY LEVEL FLOOR PLANS (1/8" = 1'-0")
	1	LOWER LEVEL FLOOR PLAN - NORTH
	2	LOWER LEVEL & MAIN LEVEL FLOOR PLANS - SOUTH
	3	MAIN LEVEL FLOOR PLAN - NORTH
	4	ROOF PLAN
ELEVATIONS		
A3	1	ELEVATIONS - NORTH & EAST ELEVATIONS
	2	ELEVATIONS - SOUTH & WEST ELEVATIONS
SECTIONS		
	1	SECTION A-A (OVERALL NORTH/SOUTH)
	2	SECTION B-B (OVERALL EAST/WEST)
	3	SECTION C-C (PARTIAL AT WEST MASTER SUITE)
	4	SECTION D-D (PARTIAL AT GREAT RM / EAST MASTER SUITE)
	5	WALL SECTIONS - GRID LINES A, B, C, & G
	6	WALL SECTIONS - GRID LINES H, I, J
	7	WALL SECTIONS - GRID LINES 5, 6, 8, 10
	8	WALL SECTIONS / STAIR DETAILS (FIREPLACES, WINDOW BEDS, INT. & EXT. STAIRS)
SCHEDULES AND DETAILS		
A5	1	DOOR / WINDOW SCHEDULES
	2	DETAILS - TRIM (INTERIOR & EXTERIOR)
	3	DETAILS - EAVE / BEAM / ROOF VENTING
ELECTRICAL		
E1	1	ELECTRICAL LEGENDS - ELECTRICAL / FIXTURE / APPLIANCE & EQUIPMENT / GENERAL NOTES
	1	LOWER LEVEL ELECTRICAL PLAN - NORTH
	2	LOWER LEVEL & MAIN LEVEL ELECTRICAL PLANS - SOUTH
	3	MAIN LEVEL ELECTRICAL PLAN - NORTH
STRUCTURAL		
	1	DETAILS - FOUNDATION
	2	DETAILS - FOUNDATION
S1	3	DETAILS - FLOOR AND ROOF FRAMING
	4	DETAILS - FLOOR AND ROOF FRAMING
	5	DETAILS - ROOF TRUSS CONFIGURATIONS
	0	OVERALL FOUNDATION PLAN (1/8" = 1'-0")
	1	FOUNDATION PLAN - NORTH
	2	FOUNDATION PLAN - SOUTH
S2	3	MAIN LEVEL FLOOR FRAMING PLAN
	4	MECHANICAL LEVEL FRAMING PLAN
	5	ROOF FRAMING PLAN - NORTH
	6	ROOF FRAMING PLAN - SOUTH
S3	1	TIMBER / STEEL FRAMING ELEVATIONS
	2	TIMBER / STEEL FRAMING ELEVATIONS
	3	TIMBER / STEEL FRAMING ELEVATIONS
	4	TIMBER / STEEL FRAMING ELEVATIONS

I HEREBY CERTIFY THAT THIS PLAN, SPECIFICATION, OR REPORT WAS PREPARED BY ME OR UNDER MY DIRECT SUPERVISION WITH MICHAEL DONOHUE AND THAT I AM A DULY LICENSED ARCHITECT UNDER THE LAWS OF THE STATE OF COLORADO.

THIS STAMP APPLIES TO ALL THE DRAWINGS LISTED IN THE INDEX OF DRAWINGS.

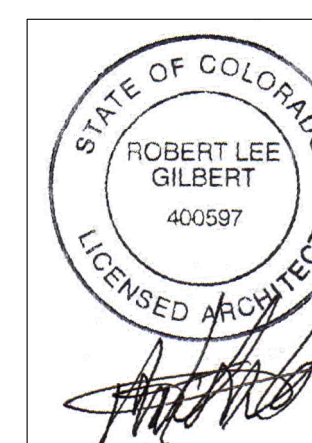

Project: LOT 226BR RESIDENCE

LOT 226BR MOUNTAIN VILLAGE, CO

stillwater architecture

25 Lone Mountain Trail
Big Sky, MT 59716
406-223-3009

P.O. Box 1742
Boulder, CO 80506
Ph. 720-441-7450

1657 North Rockwell St.
Chicago, IL 60647
Ph. 312-655-0940

© 2021

ISSUE	DATE
DRB SUBMITTAL	02.22.21
DRAWN BY:	M.B.D.
CHECKED BY:	R.L.G.
JOB No.:	1109

A0.I

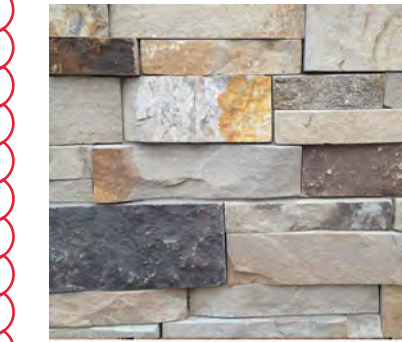

EXTERIOR STONE



EXTERIOR SIDING



EXTERIOR BEAMS/COL'S



EXT. ROOFING/METAL



EXTERIOR RAILING



EXTERIOR DECKING



EXT. WIN/DR. CLADDING

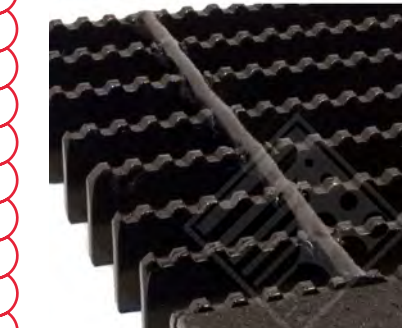

EXT. STAIR TREADS



MATERIAL	SQ. FT.	%
WINDOWS	1095.2	20.08%
STONE	1833.5	33.53%
WOOD	2088.9	38.38%
METAL	437.39	8.00%
TOTAL	5468	100.00%

Rante Telluride Residence
 Lot 226BR
 Mountain Village, CO

stillwater
 architecture

1657 N. Rockwell
 Chicago, IL 60647
 312-655-0940

P.O. Box 702
 Lyons, CO 80540
 720-441-7446

© 2018. All Rights Reserved

www.stillwaterarchitecture.com

No.	Date

Project No. Project
 Drawn By: WJRF
 Checked By: Checker

AI.O

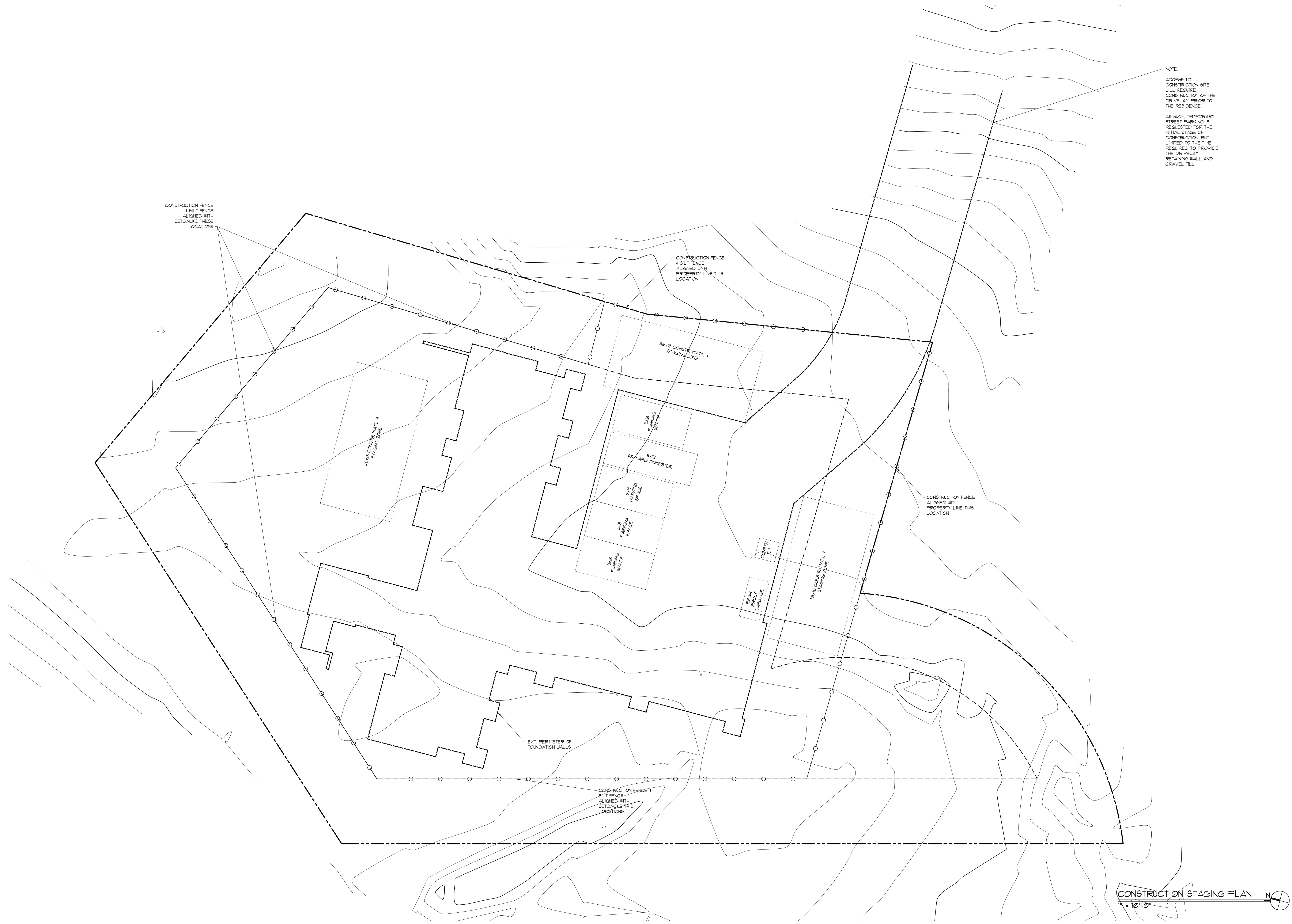

NOTE:
 ACCESS TO CONSTRUCTION SITE WILL REQUIRE CONSTRUCTION OF THE DRIVEWAY PRIOR TO THE RESIDENCE.
 AS SUCH, TEMPORARY STREET PARKING IS REQUESTED FOR THE INITIAL STAGE OF CONSTRUCTION, BUT LIMITED TO THE TIME REQUIRED TO PROVIDE THE DRIVEWAY RETAINING WALL AND GRAVEL FILL.

Project:
LOT 226BR RESIDENCE
 LOT 226BR
 MOUNTAIN VILLAGE, CO

stillwater
 architecture

25 Lone Mountain Trail
 Big Sky, MT 59716
 406-223-3009

P.O. Box 1742
 Boulder, CO 80506
 Ph. 720.441.7450

1657 North Rockwell St.
 Chicago, IL 60647
 Ph. 312-655-0940

© 2021

ISSUE	DATE
DRB SUBMITTAL	02.22.21

DRAWN BY: M.B.D.
 CHECKED BY: R.L.G.
 JOB No.: 1109

CONSTRUCTION STAGING PLAN
 1" = 10'-0" N

AI.4

Wildfire Mitigation Plan

Zone 1 is the area that consists of fifteen feet (5') around the building as measured from the outside edge of the building's drip line, including decks, planters or patios attached to the building.

The following provisions shall apply in Zone 1:

- All slash and flammable vegetation as identified by staff shall be removed from Zone 1.
- All trees and shrubs located within Zone 1 shall be removed.
- The following exceptions apply to Zone 1:
 - A tree or shrub may remain within Zone 1 provided the defensible space distance is measured commencing from the vegetation's drip edge rather than from the building plane (so the tree is considered part of an extension of the structure), and provided the distance is not limited by a lot line.
 - Flammable vegetation shall be allowed in planters attached to the building as long as the planter is within ten feet (10') of a building and vegetation is not planted directly beneath windows or next to foundation vents.
 - In the event Zone 1 encroaches upon the general easement, the review authority shall allow the creation of defensible space as required by this section.

Zone 2 is the area that extends from the outer edge of Zone 1 for the distance specified in Figure 6-1, Fire Mitigation Zones, based on slope, to the lot line, whichever is less.

The following provisions shall apply in Zone 2:

- Conifer and deciduous live trees with a dbh of four inches (4") or greater shall be spaced with a ten-foot (10') crown-to-crown separation. All ladder fuels and slash shall be removed from the ten-foot (10') crown-to-crown separation areas.
- All stressed, diseased, dead, or dying trees and shrubs, as identified by staff, shall be removed except for standing dead trees that staff indicates need to be maintained since standing dead trees provide important wildlife habitat.
- Shrubs over five feet (5') tall shall have an average spacing of ten feet (10') from shrub-to-shrub.
- The following exceptions apply to Zone 2:
 - Groupings of trees or shrubs may be allowed provided that all of the crowns in such group of trees or the edge of the shrubs are spaced ten feet (10') from crown-to-crown or from edge of shrub to any tree or shrub outside of such grouping.
 - Aspen, serotinous cottonwoods, willows and other trees and shrubs listed in CDU Cooperative Extension Publication 6305 Firewise Plant Materials as exempted from this rule may be spaced closer than the ten-foot (10') crown-to-crown separation as approved by staff.
 - Closer spacing of any trees may be allowed by staff upon a determination that the required ten-foot (10') crown-to-crown spacing would put the remaining trees at undue risk of wind-throw or snow breakage.
 - Tree removal for the creation of defensible space, if such tree removal is determined to be impractical by the Town due to steep slopes, wetland or other environmental constraints, and other mitigation is provided:
 - Trees remaining within Zone 2 shall have branches pruned to a height of ten feet (10') but not including said height requirement, branches need not be pruned to more than one-third (1/3) of the tree height with the following exceptions:
 - Aspen trees and
 - Isolated spruce and fir trees.
 - In the event that Zone 1 or 2 extends upon the general easement, the review authority shall allow the removal of trees to implement the wildfire mitigation plan.

- Chipped wood and small timber may be spread throughout either Zone 2 or Zone 3 provided the wood chips have a maximum depth of two to three inches (2" - 3") and small timber has a diameter of three inches (3") or less and is cut up into lengths that are three feet (3') or less.
- Zone 3 is the area extending beyond Zone 2 to the edge of the lot subject to development. In Zone 3, all diseased, beetle infested, dead or dying trees, as identified by staff, shall be removed except for standing dead trees (aka tree snags) that staff indicates need to be maintained since standing dead trees provide important wildlife habitat.
- For lots greater than five (5) acres in size, the Town shall only require that Zone 3 be implemented for a distance of 500 feet from the outside edge of Zone 2. A lot owner may propose to implement Zone 3 for all of the lot.

Firewood may only be stored on a lot that has a solid fuel burning device permit issued by the Town that meets the following limitations:

- Indoor storage can only occur within an enclosed room that is a part of the primary structure on the lot.
- Outdoor storage shall only occur in the rear yard.
- Up to ten (10) cubic feet of outdoor firewood storage may be located in Zone 1 or Zone 2.
- Outdoor firewood storage larger than ten (10) cubic feet shall have a minimum thirty-foot (30') distance from the structure.
- Outdoor firewood storage shall be screened from view from surrounding lots.

Prior to the issuance of any certificate of occupancy or certificate of completion, staff shall inspect the lot affected by the Fire Mitigation plan to ensure that such plan has been implemented in accordance with the approved wildfire mitigation plan.

The wildfire mitigation plan shall be maintained by the lot owner as required by this section.

Tree Preservation and Removal Policy

- Subject to review and approval by the review authority trees shall only be removed from a lot for:
 - Approved development as permitted by the CDC
 - Approved Fire Mitigation
 - Approved forest management
 - View corridors from windows provided the removal of such trees is minimized.
 - Utilities provided it is not practical for the utilities to follow the driveway or other corridors where trees are being removed as allowed by this section.
 - Renewable energy systems provided it is not possible to locate such on the buildings allowed on the lot, or within areas where trees are already being removed as allowed by this section.
 - Site area access as may be permitted by the review authority.
 - Potential damage to a structure or other constructed improvement of a lot, such as a utility line or utility meter, tranny or skimming equipment and/or
 - Protection of the public health, safety or welfare.
- No tree four inches (4") or greater dbh located on any lot within the town may be removed or naturally altered without the prior written approval of the review authority.
 - All dead or live trees with a diameter of four inches (4") or greater shall be preserved on the site unless the review authority has approved the removal of such trees as a part of the required development application process.
- A tree removal development application must be submitted to the Town prior to the removal or material alteration of any dead or living tree greater than four inches (4") dbh. Such development application shall include the information and plans as required by this section. d. Trees, living or dead, to be removed from the general easement or open space must be marked and field inspected prior to removal.
 - Trees removed by the ski resort operator in the ordinary operation of the ski area or golf course, including without limitation trees removed for utility and snow making installation, are exempt from the requirements of this section provided notice and information is provided to the Planning Division and it determines that the tree removal is part of the ordinary operation of the ski area or golf course. Other tree removal that is deemed by the Planning Division to not be a part of the ordinary operation of the ski or golf course operations requires the submission of a tree removal development application pursuant to the requirements of this section and the CDC.
- The Town has the right to remove any trees on Town-owned lot for forest health or fire mitigation provided the trees to be removed have been marked and staff inspects and approves the proposed tree removal.
 - Any tree deemed by staff to be a hazard to any building, structure, public facility, roadway, adjacent lot, gas line, well head, telephone, and/or electrical box shall be removed by the owner of the lot or the affected utility agency within a reasonable amount of time (as determined by the Town based on the nature of the hazard) after notification. Discussion of the hazard and the Town's approval of the tree removal shall be provided prior to the removal of the hazard tree.
 - In cases of an emergency, a hazard tree may be removed without prior approval if prior documentation of the hazard is provided to the Town that clearly shows the emergency nature of the tree removal. Such emergency tree removal shall be reported and the required documentation provided within forty-eight (48) hours of the tree removal.
- All development shall use the following best management practices to protect and preserve trees that will be retained on a project site:
 - All dead or live trees with a dbh of four inches (4") or greater that are to be saved that may be affected by construction shall be protected by placing and maintaining fencing at the tree's drip line.
 - The Building Regulations required construction mitigation plan shall show the location of all required fencing to protect trees in close proximity to grading or other construction activity.
 - Developers shall use extreme care during grading and excavation to avoid damage or removal of existing trees and shrubs to be retained on a project site and to preserve their root structures.
 - No vehicles shall be parked within the drip line of a tree or shrub to be retained.
 - No access shall be constructed within the drip lines of trees to be retained.
 - No grading shall occur on a site until approved fencing is placed at the drip line of trees and shrubs to be retained on the project site.
 - All trees to be retained shall be clearly marked on the project site to ensure such trees are not removed.
 - Timber and slash generated during development shall be removed from the site within thirty (30) days of cutting. No burning of wood or any other material is permitted.

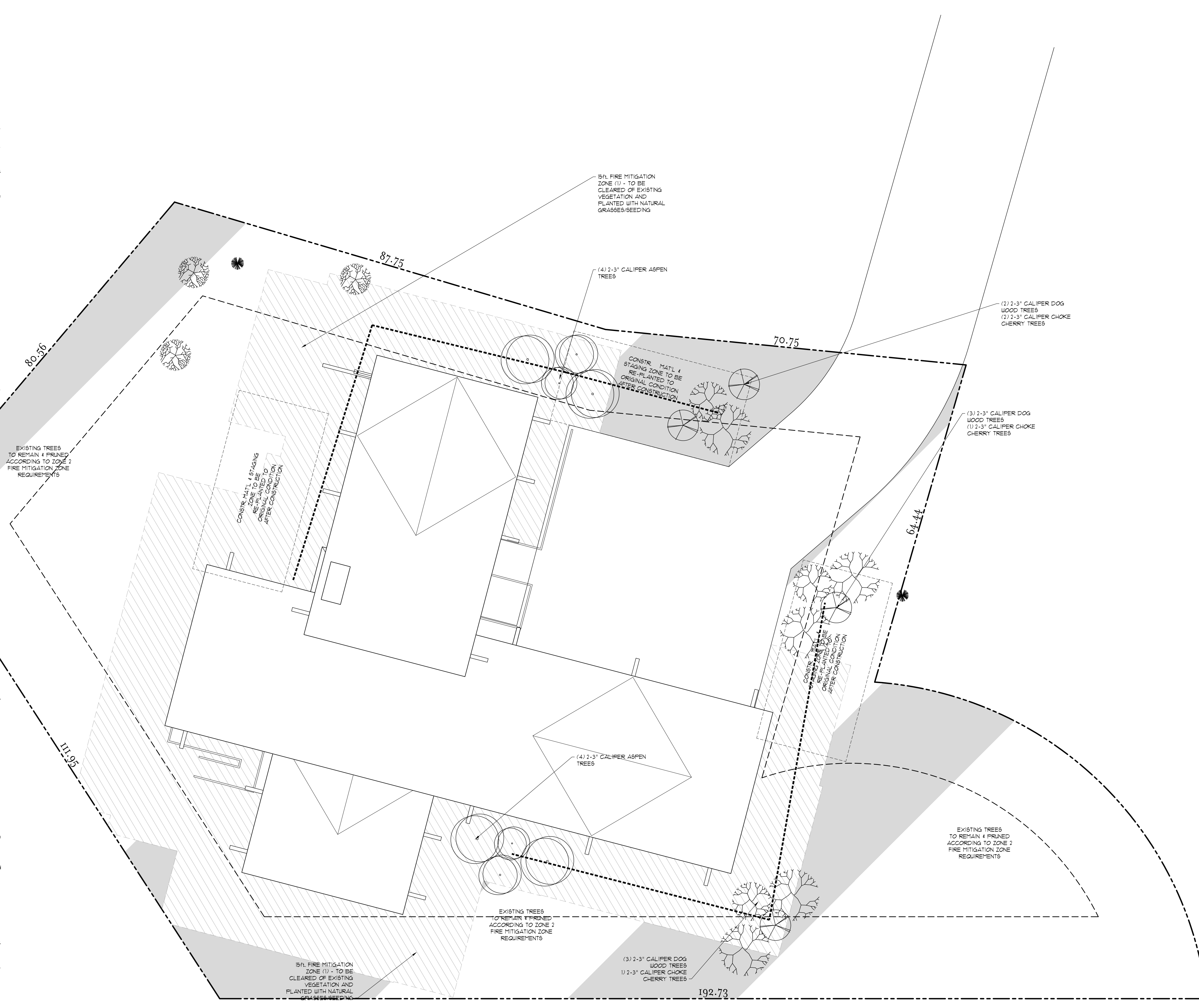

FIRE ZONE MITIGATION LEGEND

FIRE MITIGATION ZONE 1

FIRE MITIGATION ZONE 2

LANDSCAPE LEGEND

ASPEN TREES

DOGWOOD TREE

CHOKO CHERRY TREE

EXISTING TREE TO REMAIN

EXISTING TREE TO REMAIN

TEMPORARY IRRIGATION LINE TO ESTABLISH NEW TREES

LANDSCAPE PLAN

1" = 10'-0"

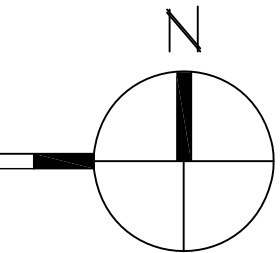

Project: **LOT 226BR RESIDENCE**
LOT 226BR
MOUNTAIN VILLAGE, CO

stillwater
architecture

25 Lone Mountain Trail
 Big Sky, MT 59716
 406-223-3009

P.O. Box 1742
 Boulder, CO 80506
 Ph. 720-441-7450

1657 North Rockwell St.
 Chicago, IL 60647
 Ph. 312-655-0947

© 2021

ISSUE	DATE
DRB SUBMITTAL	02.22.21

DRAWN BY: M.B.D.
 CHECKED BY: R.L.G.
 JOB No.: 1109

AI.3

Building Height Calculations		
Roof	Grade	Height
16.05	-11.78	27.83
16.05	-10.90	26.95
17.17	-10.83	28.00
15.17	-10.83	26.00
15.17	-8.30	23.47
17.17	-8.30	25.47
11.89	-8.99	20.87
11.89	-10.83	22.72
13.17	-9.87	23.03
13.17	-11.35	24.52
Average:		24.89

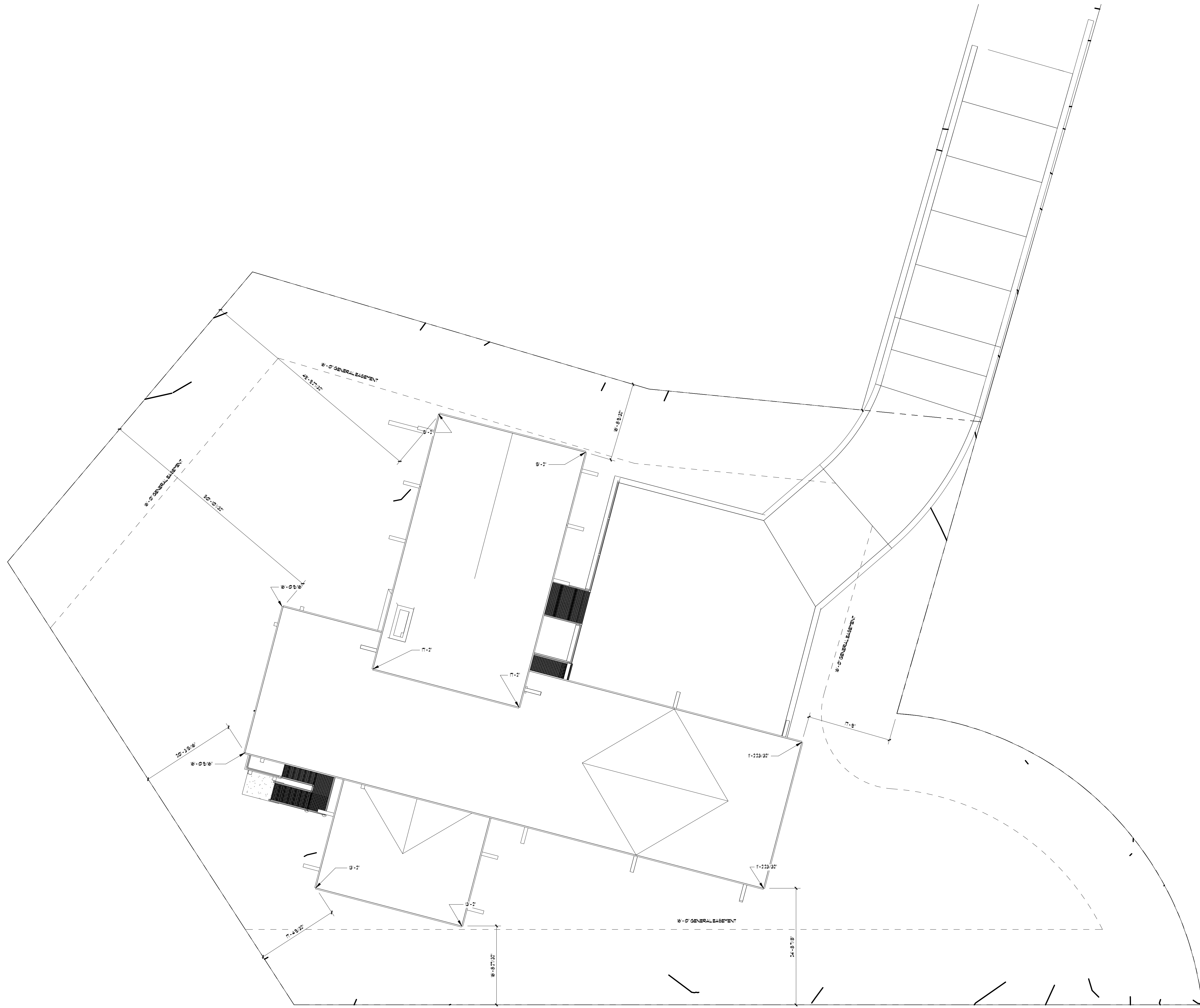

Site Plan
1" = 10'-0"

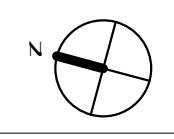

Rante Telluride Residence
Lot 226BR
Mountain Village, CO

stillwater
architecture

1657 N. Rockwell
Chicago, IL 60647
312-655-0940

P.O. Box 702
Lyons, CO 80540
720-441-746

© 2018. All Rights Reserved

www.stillwaterarchitecture.com

No.	Date

Project No. _____
Drawn By: *WJBP*
Checked By: _____

AI.I

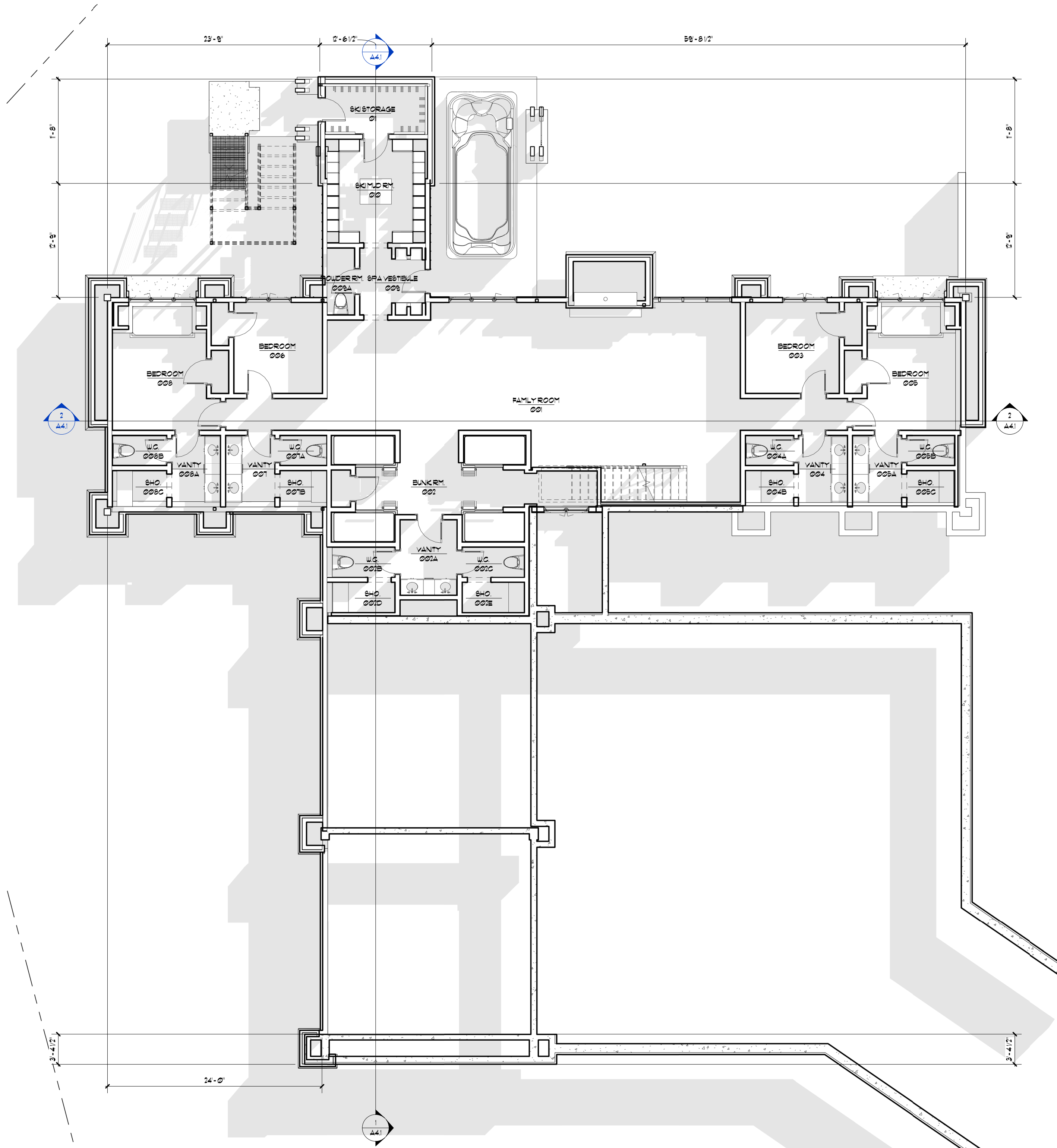

Lower Level Floor Plan
1/8" = 1'-0"

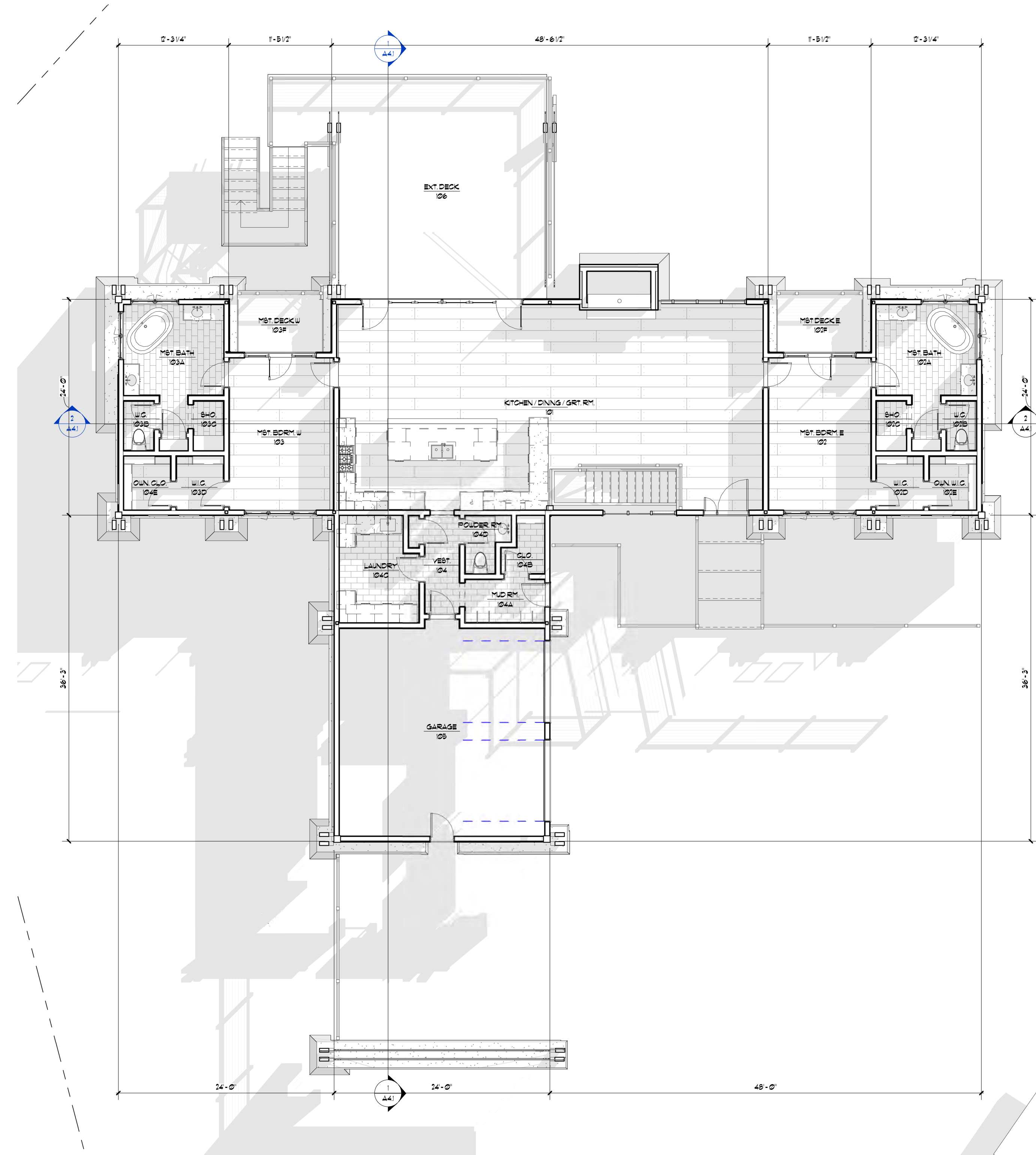

Main Level Floor Plan
1/8" = 1'-0"

Rante Telluride Residence
Lot 226BR
Mountain Village, CO

stillwater
architecture

1657 N. Rockwell
Chicago, IL 60647
312-655-0940
P.O. Box 702
Lyons, CO 80540
720-441-7446

© 2018. All Rights Reserved

www.stillwaterarchitecture.com

No.	Date

Project No: _____
Drawn By: *MAR*
Checked By: _____
Project *MAR*
Checker _____

A2.0

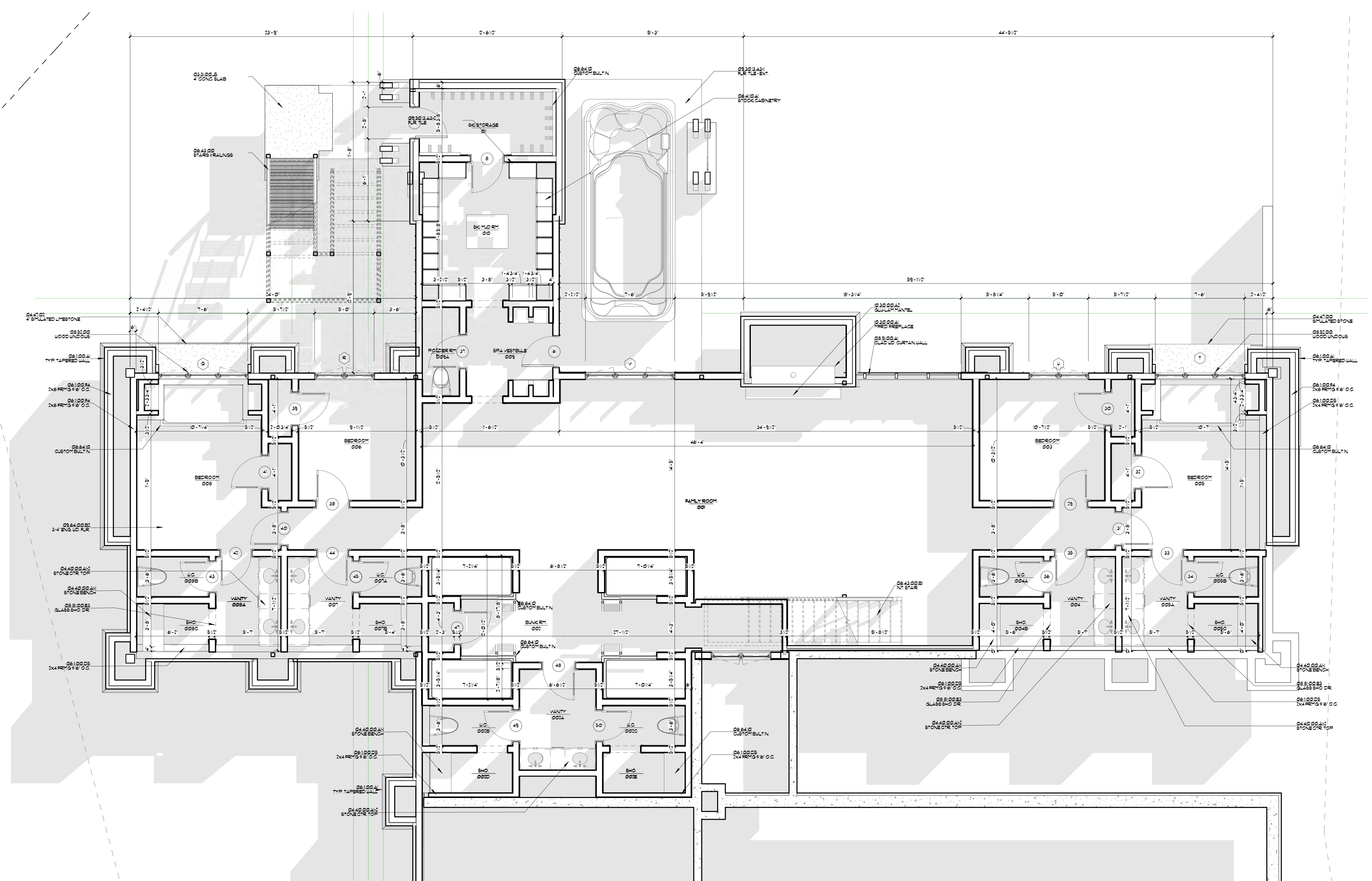

Lower Level Floor Plan - North
 1/4" = 1'-0"

Rante Telluride Residence
 Lot 226BR
 Mountain Village, CO

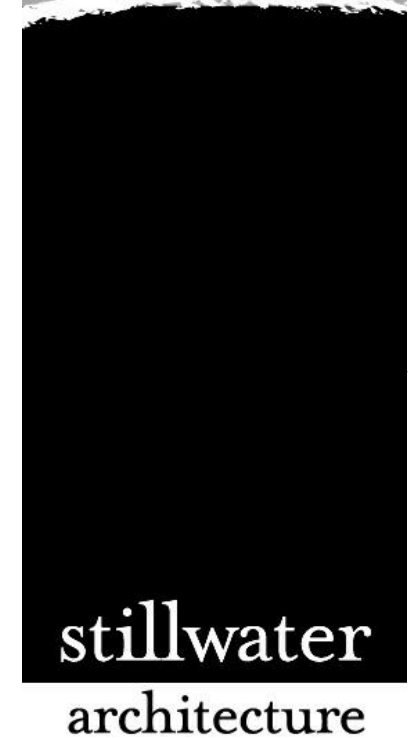

1657 N. Rockwell
 Chicago, IL 60647
 312-655-0940
 P.O. Box 702
 Lyons, CO 80540
 720-441-7446

© 2018. All Rights Reserved

www.stillwaterarchitecture.com

No.	Date

Project No. _____ Project Name _____
 Drawn By _____
 Checked By _____

A2.I

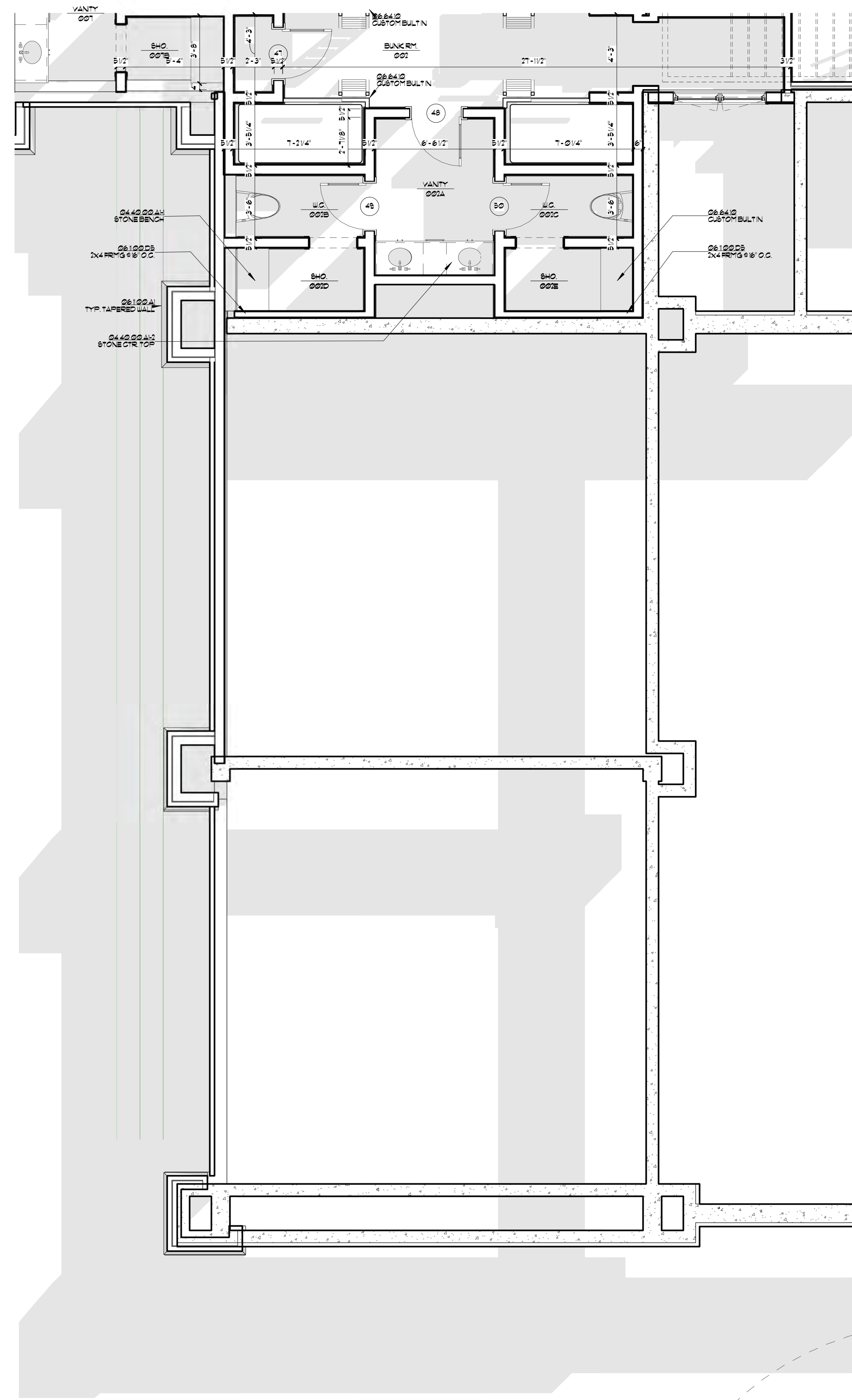

Lower Level Floor Plan - South
1/4" = 1'-0"

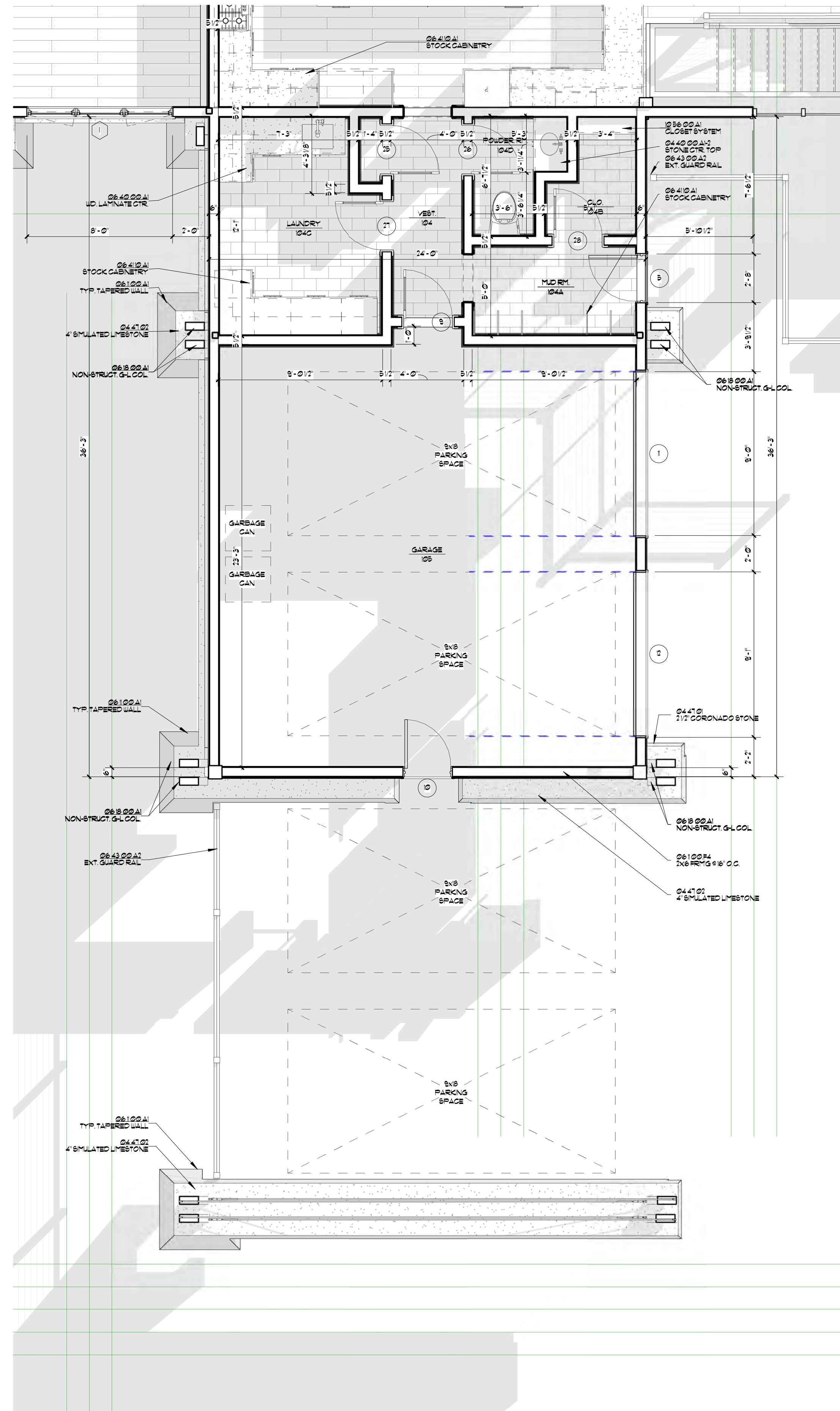

Main Level Floor Plan - South
1/4" = 1'-0"

Rante Telluride Residence
Lot 226BR
Mountain Village, CO

stillwater
architecture

1657 N. Rockwell
Chicago, IL 60647
312-655-0940
P.O. Box 702
Lyons, CO 80540
720-441-7416

© 2018. All Rights Reserved

www.stillwaterarchitecture.com

No.	Date

Project No: Project
Drawn By: Name
Checked By: Checker

A2.2

Rante Telluride Residence
 Lot 226BR
 Mountain Village, CO



1657 N. Rockwell
 Chicago, IL 60647
 312-655-0940
 P.O. Box 702
 Lyons, CO 80540
 720-441-7446

© 2018. All Rights Reserved

www.stillwaterarchitecture.com

No.	Date

Project No.
 Drawn By:
 Checked By:
 Project
 Manager
 Checker

A2.3

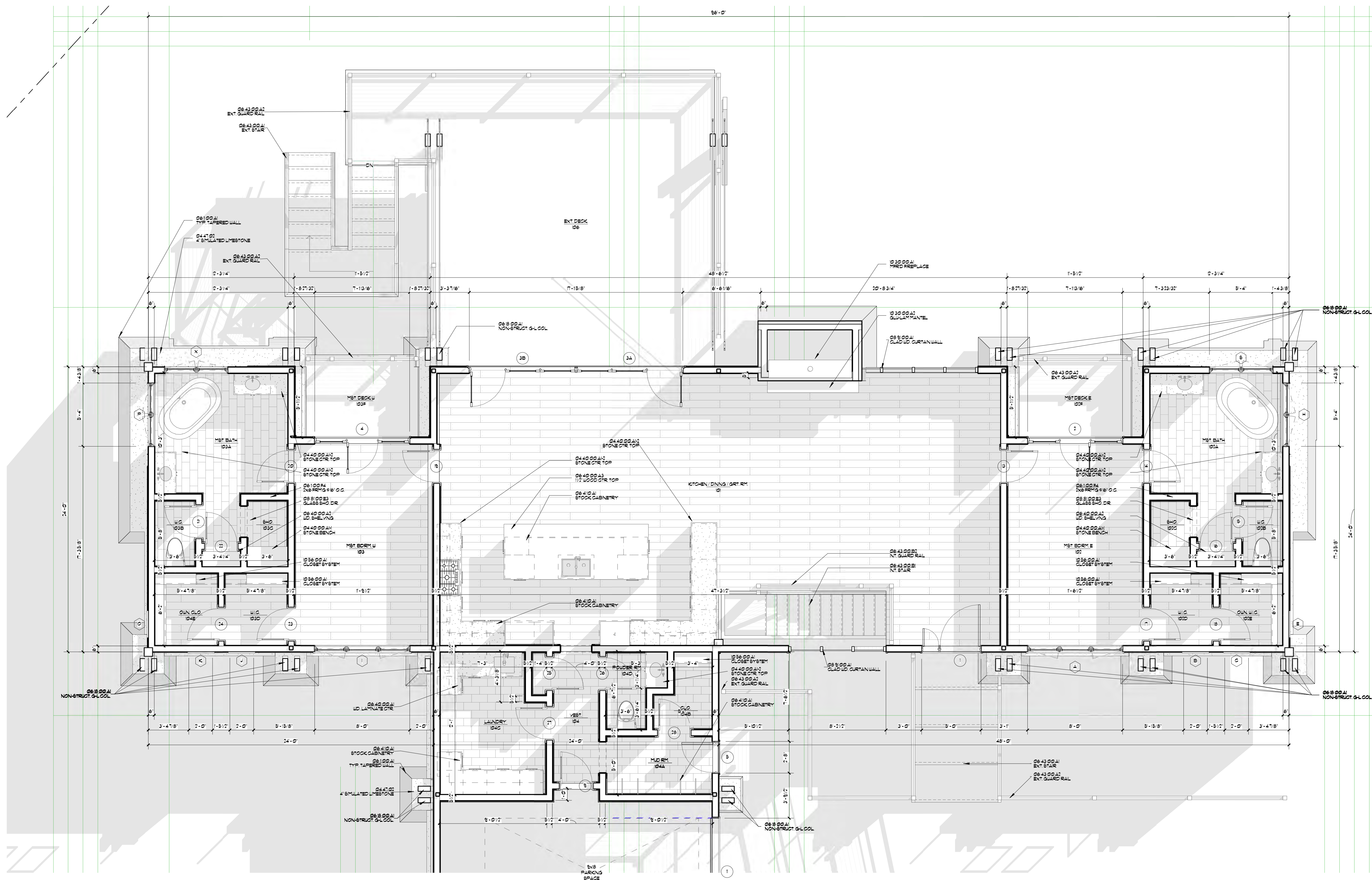

Main Level Floor Plan - North
 1/4" = 1'-0"

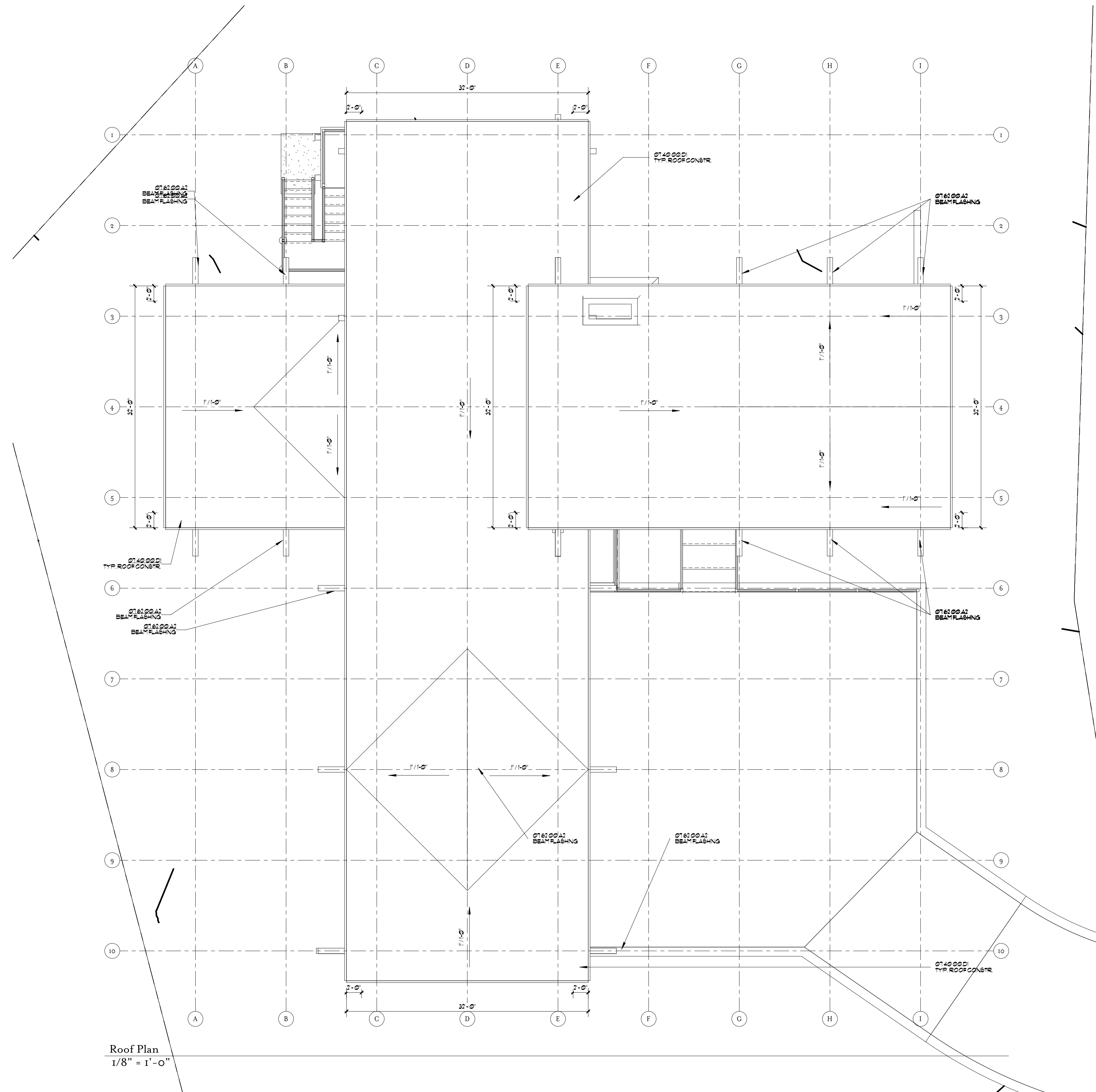

Roof Plan
 1/8" = 1'-0"

Rante Telluride Residence
 Lot 226BR
 Mountain Village, CO

stillwater
 architecture

1657 N. Rockwell
 Chicago, IL 60647
 312-655-0940

P.O. Box 702
 Lyons, CO 80540
 720-441-7446

© 2018. All Rights Reserved

www.stillwaterarchitecture.com

No.	Date

Project No. _____ Project
 Drawn By: *WJP/BJF*
 Checked By: _____ Checker

A2.4

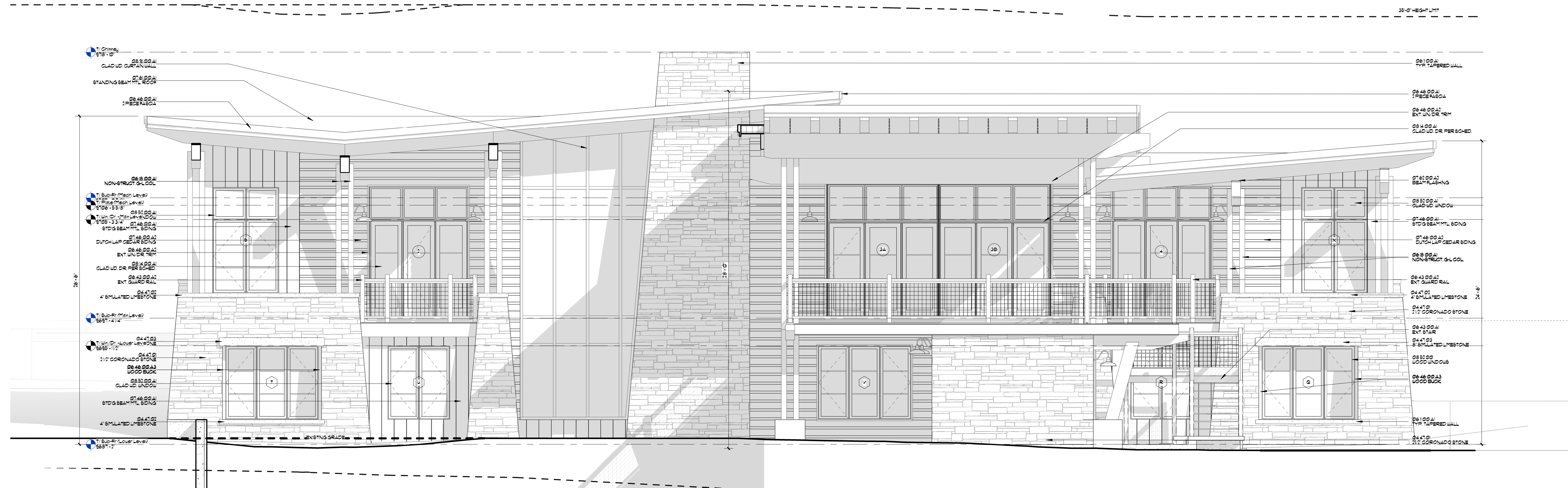

North Elevation
1/4" = 1'-0"

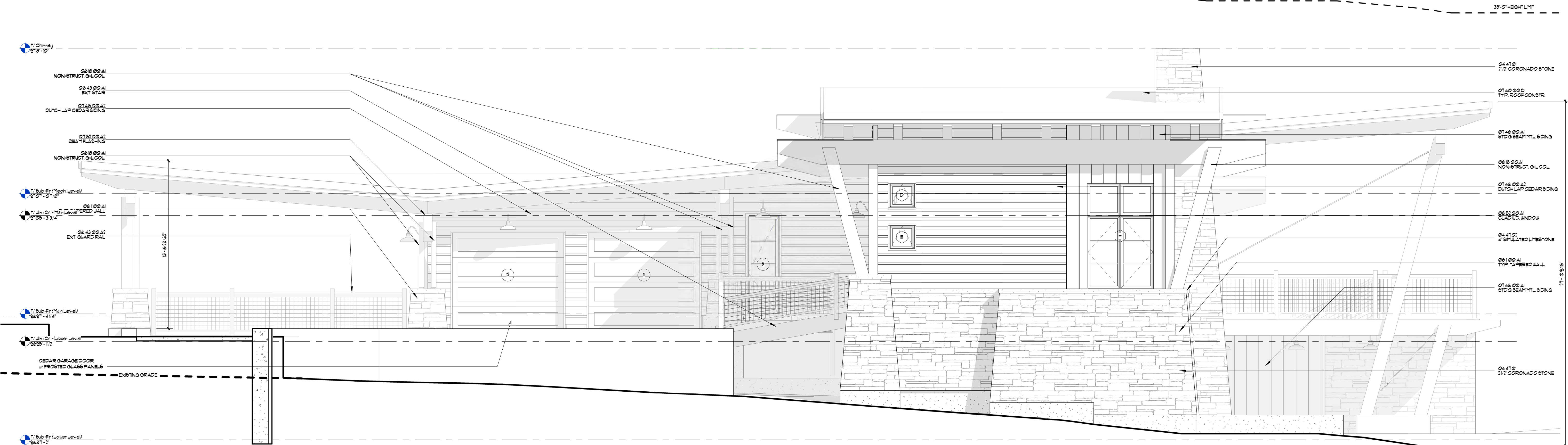

East Elevation
1/4" = 1'-0"

Rante Telluride Residence
Lot 226BR
Mountain Village, CO

stillwater
architecture

1657 N. Rockwell
Chicago, IL 60647
312-655-0940
P.O. Box 702
Lyons, CO 80540
720-441-7446

© 2018. All Rights Reserved

www.stillwaterarchitecture.com

No.	Date

Project No. _____
Drawn By: *MWP/BJ*
Checked By: _____

A3.1

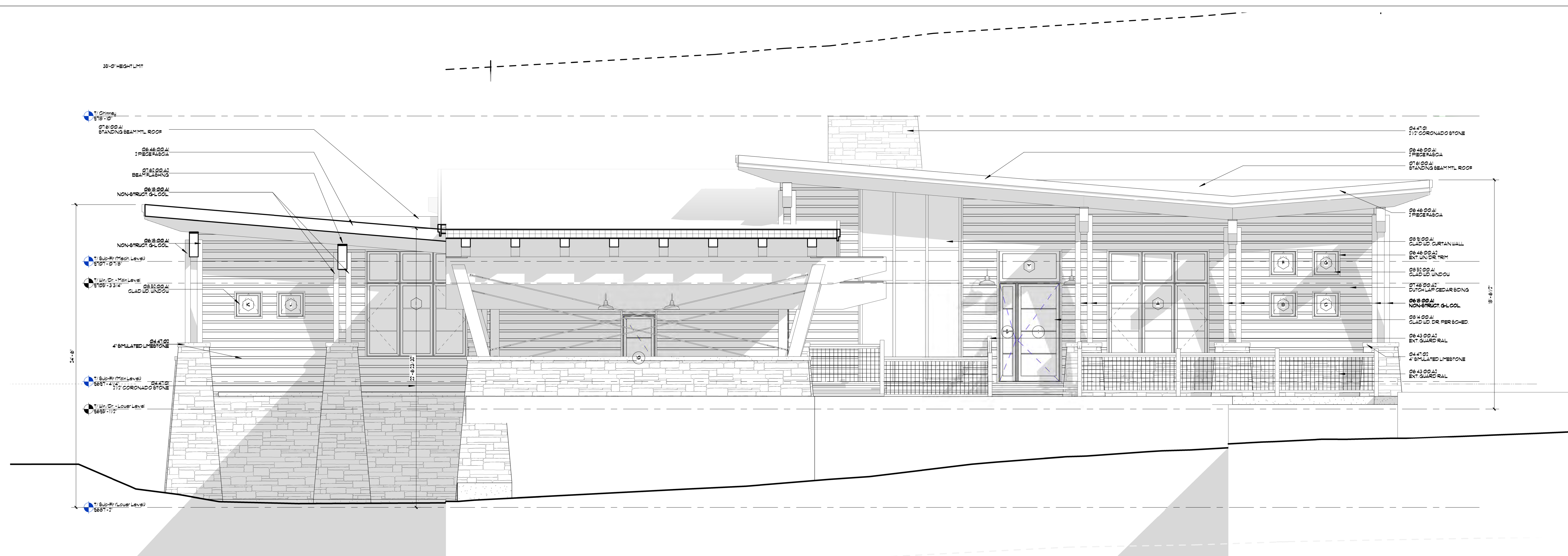

South Elevation
1/4" = 1'-0"

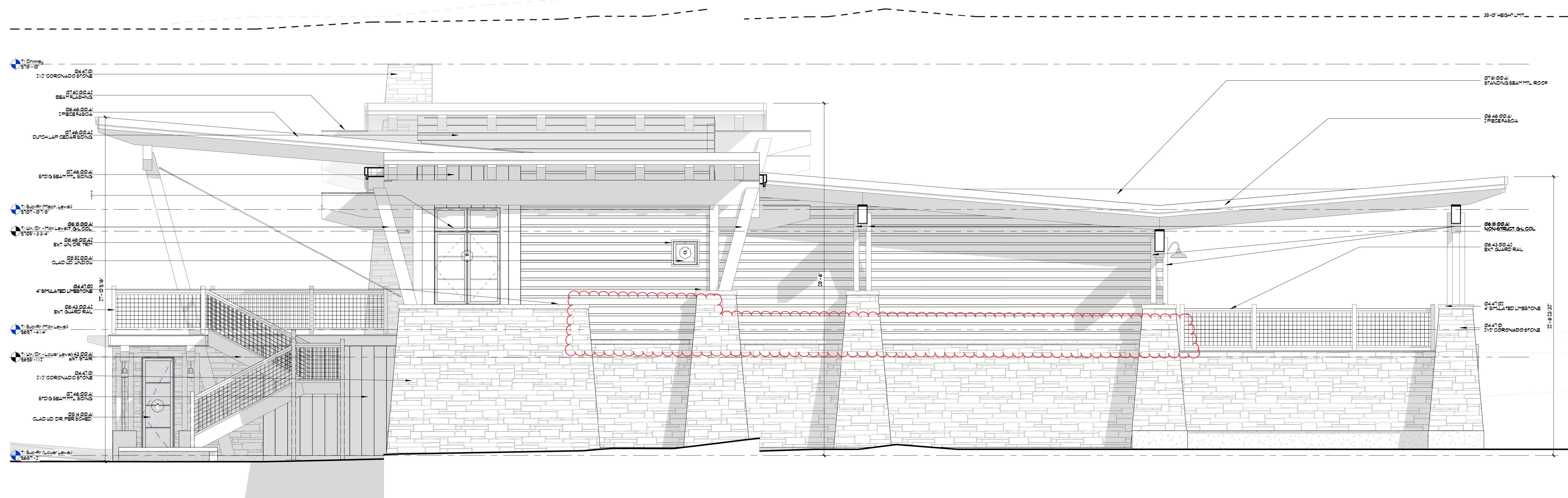

West Elevation
1/4" = 1'-0"

Rante Telluride Residence
Lot 226BR
Mountain Village, CO

stillwater
architecture

1657 N. Rockwell
Chicago, IL 60647
312-655-0940

P.O. Box 702
Lyons, CO 80540
720-441-7446

© 2018. All Rights Reserved

www.stillwaterarchitecture.com

No.	Date

Project No. _____
Drawn By: *MAR*
Checked By: _____

Project _____
Checked By: _____

A3.2

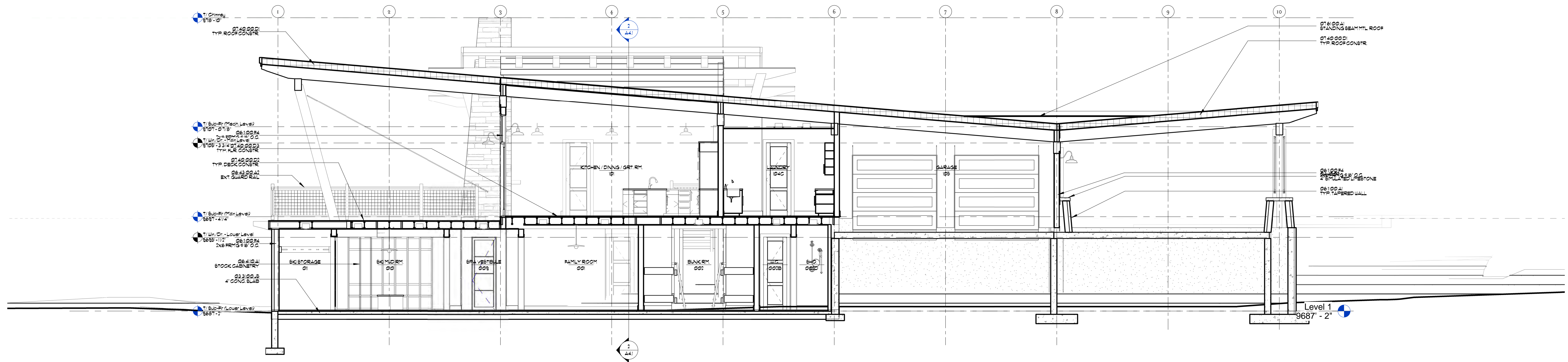

BUILDING SECTION A-A
3/16" = 1'-0"

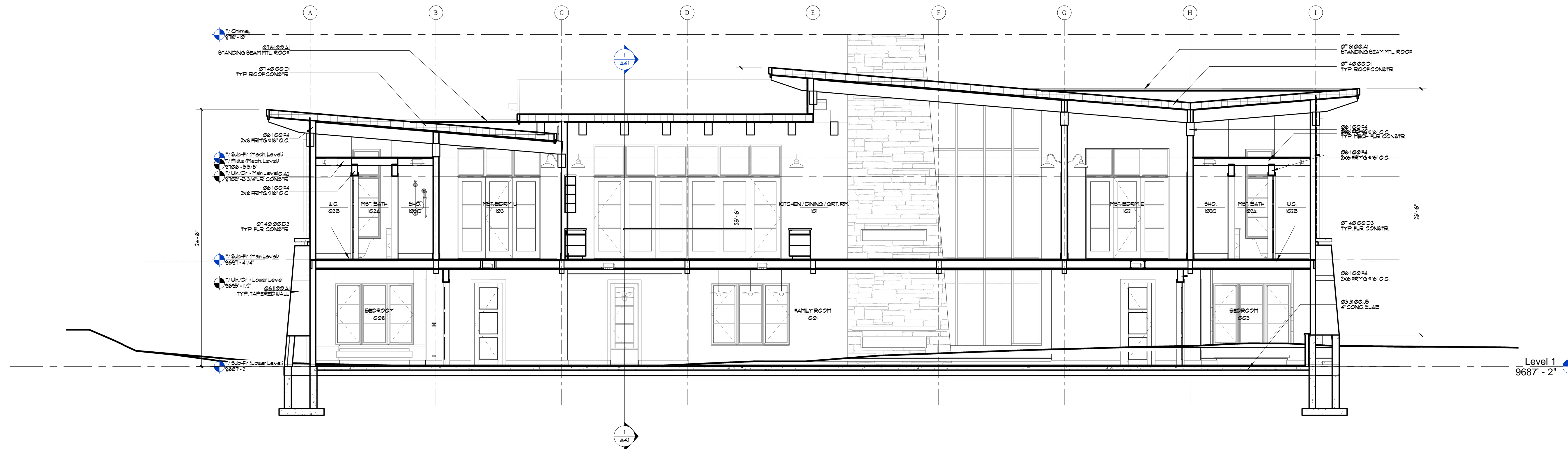

BUILDING SECTION B-B
3/16" = 1'-0"

Rante Telluride Residence
Lot 226BR
Mountain Village, CO

stillwater
architecture

1657 N. Rockwell
Chicago, IL 60647
312-655-0940
P.O. Box 702
Lyons, CO 80540
720-441-7446

© 2018. All Rights Reserved

www.stillwaterarchitecture.com

No.	Date

Project No.	Project
Drawn By: <i>MJP/RF</i>	Checked By:
Checked By:	Checker

A4.I

Door Schedule									
SYM	MFR	MODEL	ROU	ROH	THCK	EXT.FN.	GLAZING	INT.FN.	LGTH AREA
1	TBD	VL8636	3'-6 1/2"	8'-0 1/2"		Clad Alu+Black		Pne	
2	TBD	UPD8880	8'-0 3/8"	10'-8"	1 3/4"		Lou Bl+Argon		81 SF
3A	TBD	UPD8880	8'-0 3/8"	1'-0"	1 3/4"		Lou Bl+Argon		84 SF
3B	TBD	UPD8880	8'-0 3/8"	1'-0"	1 3/4"		Lou Bl+Argon		84 SF
4	TBD	UPD8880	8'-0 3/8"	10'-8"	1 3/4"		Lou Bl+Argon		81 SF
5	TBD	VL8636	1'-6 1/2"	8'-0 1/2"		Clad Alu+Black		Wood+Pne	
6	TBD	VL8636	2'-8 1/2"	8'-0 1/2"		Clad Alu+Black		Wood+Pne	
7	TBD	VL8636	2'-8 1/2"	8'-0 1/2"		Clad Alu+Black		Wood+Pne	
8	TBD	FRENCH 4 PANEL	3'-4"	8'-4"	1 3/8"				
9	TBD	3-PANEL	3'-4"	8'-4"	1 3/8"				
10	TBD	VL8636	2'-8 1/2"	8'-0 1/2"		Clad Alu+Black		Wood+Pne	
11	TBD		8'-2"	8'-2"	1 1/2"				
12	TBD		8'-2"	8'-2"	1 1/2"				
13	TBD	3-PANEL	3'-4"	8'-4"	1 3/8"				
14	TBD	3-PANEL	3'-4"	8'-4"	1 3/8"				
15	TBD	3-PANEL	3'-4"	8'-4"	1 3/8"				
16	TBD	3-PANEL	3'-4"	8'-4"	1 3/8"				
17	TBD	3-PANEL	3'-4"	8'-4"	1 3/8"				
18	TBD	3-PANEL	3'-4"	8'-4"	1 3/8"				
19	TBD	3-PANEL	3'-4"	8'-4"	1 3/8"				
20	TBD	3-PANEL	3'-4"	8'-4"	1 3/8"				
21	TBD	3-PANEL	3'-4"	8'-4"	1 3/8"				
22	TBD	3-PANEL	3'-4"	8'-4"	1 3/8"				
23	TBD	3-PANEL	3'-4"	8'-4"	1 3/8"				
24	TBD	3-PANEL	3'-4"	8'-4"	1 3/8"				
25	TBD	3-PANEL	3'-4"	8'-4"	1 3/8"				
26	TBD	3-PANEL	3'-4"	8'-4"	1 3/8"				
27	TBD	3-PANEL	3'-4"	8'-4"	1 3/8"				
28	TBD	3-PANEL	3'-4"	8'-4"	1 3/8"				
29	TBD	3-PANEL	3'-4"	8'-4"	1 3/8"				
30	TBD	3-PANEL	3'-4"	8'-4"	1 3/8"				
31	TBD	3-PANEL	3'-4"	8'-4"	1 3/8"				
32	TBD	3-PANEL	3'-4"	8'-4"	1 3/8"				
33	TBD	3-PANEL	3'-2"	8'-4"	1 3/8"				
34	TBD	3-PANEL	3'-2"	8'-4"	1 3/8"				
35	TBD	3-PANEL	3'-2"	8'-4"	1 3/8"				
36	TBD	3-PANEL	3'-2"	8'-4"	1 3/8"				
37	TBD	3-PANEL	3'-4"	8'-4"	1 3/8"				
38	TBD	3-PANEL	3'-4"	8'-4"	1 3/8"				
39	TBD	3-PANEL	3'-4"	8'-4"	1 3/8"				
40	TBD	3-PANEL	3'-4"	8'-4"	1 3/8"				
41	TBD	3-PANEL	3'-4"	8'-4"	1 3/8"				
42	TBD	3-PANEL	3'-2"	8'-4"	1 3/8"				
43	TBD	3-PANEL	3'-2"	8'-4"	1 3/8"				
44	TBD	3-PANEL	3'-2"	8'-4"	1 3/8"				
45	TBD	3-PANEL	3'-2"	8'-4"	1 3/8"				
46	TBD	3-PANEL	3'-4"	8'-4"	1 3/8"				
47	TBD	3-PANEL	3'-4"	8'-4"	1 3/8"				
48	TBD	3-PANEL	3'-2"	8'-4"	1 3/8"				
49	TBD	3-PANEL	3'-2"	8'-4"	1 3/8"				
50	TBD	3-PANEL	3'-2"	8'-4"	1 3/8"				
51	TBD	VL8636	3'-6 1/2"	8'-0 1/2"		Clad Alu+Black		Pne	
52	TBD	VL8636	1'-6 1/2"	8'-0 1/2"		Clad Alu+Black		Wood+Pne	

Window Schedule												
SYM	MFR	MODEL	TYPE	H	W	ROU	ROH	EXT	INT	Divides/Lites	LIGHT	VENT
A	TBD	LCA3786	CS+TT	2'-0"	2'-0"	8'-7"	8'-6 3/4"				48 SF	23 SF
B	TBD	UAUN2424	AWN	2'-0"	2'-0"	2'-7"	1'-15 8"				16 SF	16 SF
C	TBD	UAUN2424	AWN	2'-0"	2'-0"	2'-7"	1'-15 8"				16 SF	16 SF
D	TBD	UAUN2424	AWN	2'-0"	2'-0"	2'-7"	1'-15 8"				16 SF	16 SF
E	TBD	UAUN2424	AWN	2'-0"	2'-0"	2'-7"	1'-15 8"				16 SF	16 SF
F	TBD	UAUN2424	AWN	2'-0"	2'-0"	2'-7"	1'-15 8"				16 SF	16 SF
G	TBD	UAUN2424	AWN	2'-0"	2'-0"	2'-7"	1'-15 8"				16 SF	16 SF
H	TBD	CA3786	CS+TT			8'-5"	8'-6 3/4"				33 SF	23 SF
I	TBD	LCA3786	CS+TT			8'-7"	8'-6 3/4"				48 SF	23 SF
J	TBD	UAUN2424	AWN	2'-0"	2'-0"	2'-7"	1'-15 8"				16 SF	16 SF
K	TBD	UAUN2424	AWN	2'-0"	2'-0"	2'-7"	1'-15 8"				16 SF	16 SF
L	TBD	UAUN2424	AWN	2'-0"	2'-0"	2'-7"	1'-15 8"				16 SF	16 SF
M	TBD	UAUN2424	AWN	2'-0"	2'-0"	2'-7"	1'-15 8"				16 SF	16 SF
N	TBD	UAUN2424	AWN	2'-0"	2'-0"	2'-7"	1'-15 8"				16 SF	16 SF
O	TBD	UAUN2424	AWN	2'-0"	2'-0"	2'-7"	1'-15 8"				16 SF	16 SF
P	TBD	CA3786	CS+TT			8'-5"	8'-6 3/4"				33 SF	23 SF
Q	TBD	LCA397	CS+TT	8'-0"		7'-7"	8'-15 8"				33 SF	26 SF
R	TBD	LCA397	CS+TT	8'-0"		8'-7"	8'-15 8"				22 SF	26 SF
S	TBD	CA3786	CS+TT			8'-5"	8'-6 3/4"				33 SF	23 SF
T	TBD	LCA397	CS+TT	8'-0"		7'-7"	8'-15 8"				33 SF	26 SF
U	TBD	LCA397	CS+TT	8'-0"		8'-7"	8'-15 8"				22 SF	26 SF
V	TBD	LCA397	CS+TT	8'-0"		7'-7"	8'-15 8"				33 SF	26 SF
W	TBD	LCA397	CS+TT	4'-8"		8'-7"	4'-15 8"				18 SF	8 SF
X	TBD	CA3786	CS+TT			8'-5"	8'-6 3/4"				33 SF	23 SF
Y	Kolbe & Kolbe Co. Inc.	VL72064				8'-0 1/2"	2'-8 1/2"	Clad Alu+Black	Wood+Pne	Yes		

Rante Telluride Residence
 Lot 226BR
 Mountain Village, CO

stillwater
 architecture

1657 N. Rockwell
 Chicago, IL 60647
 312-655-0940

P.O. Box 702
 Lyons, CO 80540
 720-441-7446

© 2018, All Rights Reserved

www.stillwaterarchitecture.com

No.	Date

Project No. _____ Project
 Drawn By: _____
 Checked By: _____

A5.1

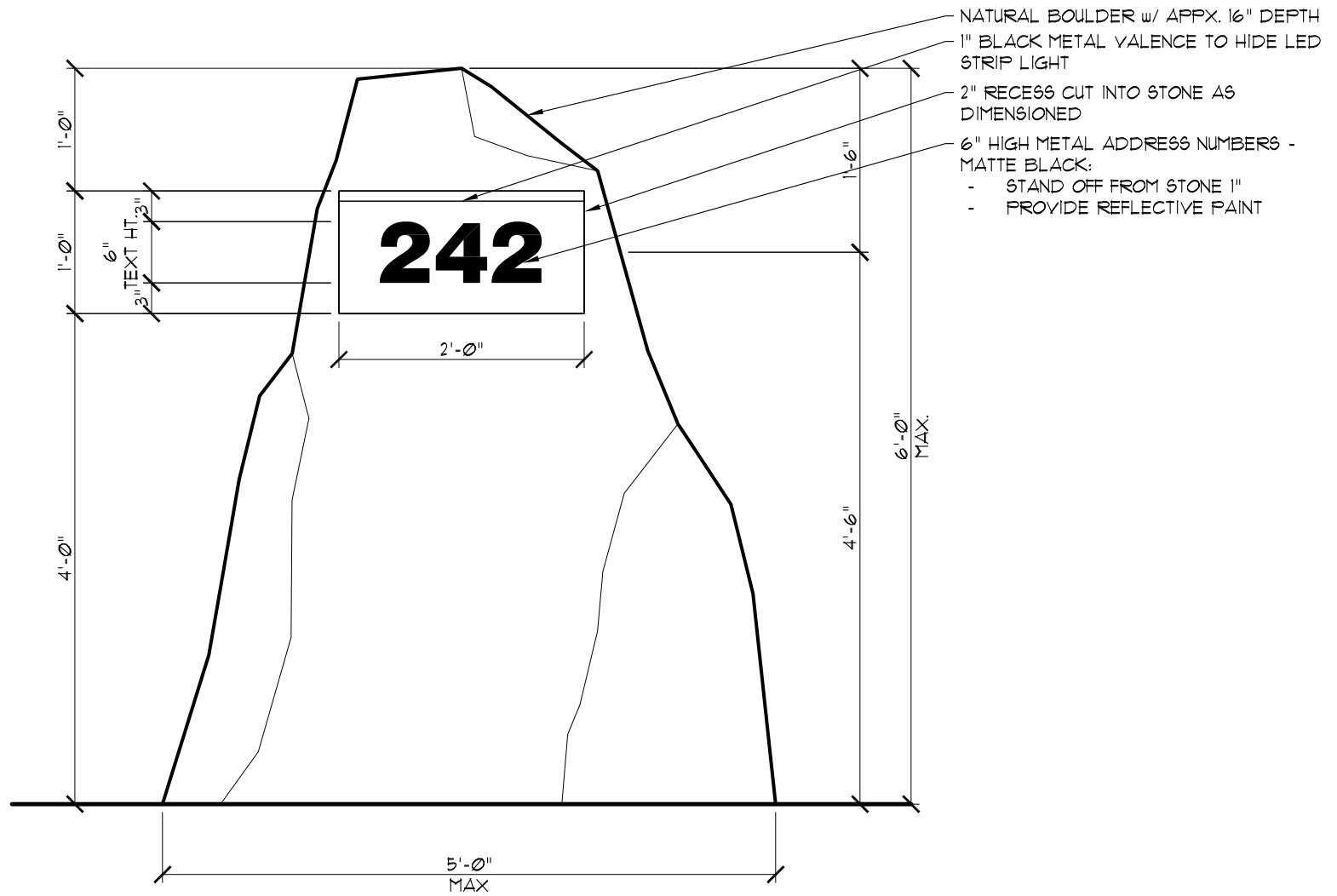

LOT 226BR ADDRESS MONUMENT





Date: _____
Type: _____
Firm Name: _____
Project: _____

Vaya Free Form Tunable White

IP40, 2700 to 6000 K, 1 m (3 ft)

Uniform, slim, flexible luminaire with tunable white light

Vaya Free Form is a flexible linear lighting solution for straight or curved coves and recessed applications. Free Form gives you even, uniform white light on any surface, in any environment. You can easily cut and connect interior Free Form, enabling illumination that conforms to unusual and difficult-to-light shapes while eliminating waste. In outdoor environments, you can cut and reseal Free Form, retaining its IP66 rating. Free Form Tunable White includes channels of warm, neutral, and cool white LEDs produce color temperatures ranging from 2700 K to 6000 K.



- **Dependable** – A tough silicone enclosure protects the LEDs in indoor and outdoor environments. Mounting options ensure exact positioning of Free Form on any surface, so your luminaires stay in place—delivering accurate, efficient light.
- **Light, Anywhere** – With its low profile, Free Form fits into the tightest of spaces. And thanks to mounting options for virtually any surface, Free Form can illuminate any cove or recess, highlight any feature, and conform to any shape.
- **Uniform Illumination** – The first thing you'll notice when you turn on Vaya Free Form is... nothing. No striation. No color shift. No visible difference between Free Form luminaires. Just even, uniform light.
- **Cost-Effective** – In interior environments, Free Form segments can be cut and connected, no soldering required. So you lower your costs by reducing waste and lessening environmental impact. Win-win.
- **Simple Installation** – Use mounting tracks for precise, straight runs, or use secure mounting clips for curves and bends. The carefully designed silicone enclosure protects the internal circuitry and keeps everything firmly in place. So the LEDs won't get damaged or change position when installing Free Form.
- **Color Temperature Choices** – Free Form Tunable White includes channels of warm, neutral, and cool white LEDs produce color temperatures ranging from 2700 K to 6000 K.
- **Global Reach** – Vaya brings exceptional (and cost-effective) lighting solutions to large-scale implementations, such as hundreds of retail stores, maintaining brand consistency between sites and across borders.

For detailed product information, please refer to the Vaya Free Form Product Guide at www.colorkinetics.com/global/products/vaya/free-form-tunable/

COLOR KINETICS
vaya series

Specifications

Due to continuous improvements and innovations, specifications may change without notice.

Output

Color Temperature	2700 K to 6000 K
Beam Angle	120°
Lumens†	1,109
Efficacy	96.2
CRI	88

Electrical

Input Voltage	24 VDC
Power Consumption (Maximum at full output, steady state)	11.5 W

Control

Dimming Module	0-10 V Dimming Module DALI Dimming Module DMX/Dynet via converter interface
----------------	---

Lumen Maintenance

Threshold	Ambient Temperature	Reported	Calculated
L90	25 °C	25,000	25,000
	50 °C	16,000	16,000
L80	25 °C	> 36,000	25,000
	50 °C	33,000	33,000
L70	25 °C	> 36,000	80,000
	50 °C	> 36,000	52,000

Physical

Dimensions	12.7 x 1000 x 4.5 mm (0.5 x 39.37 x 0.17 in) (Height x Width x Depth)
Weight	0.07 kg (0.15 lb)
Housing Material	Extruded silicone
Lens	Frosted silicone
Mounting Options	Mounting clips, mounting track
Temperature Range	-40 to 50 °C (-40 to 122 °F) Operating -20 to 50 °C (-4 to 122 °F) Startup -40 to 80 °C (-40 to 176 °F) Storage
Minimum Bend Diameter	50 mm (1.97 in)
Minimum Segment Length	100 mm (3.94 in)
Humidity	0 to 95%, non-condensing

Maximum Run Length

7 m (23 ft). To calculate luminaire run lengths for your specific installation, download the Configuration Calculator from www.colorkinetics.com/vaya/Configuration-Calculator/

Certification and Safety

Approbation	UL/cUL, CE, CQC
Environment	Damp Location, IP40



† 0.3 m (1 ft) lumen output measurements comply with IES LM-79-08 testing procedures. 5 m (15 ft) and 10 m (30 ft) measurements are estimated based on the 0.3 m (1 ft) measurements.

‡ When re-connecting segments with connectors, avoid cutting at solder joints, which appear every 500 mm (19.68 in).

Dimensions

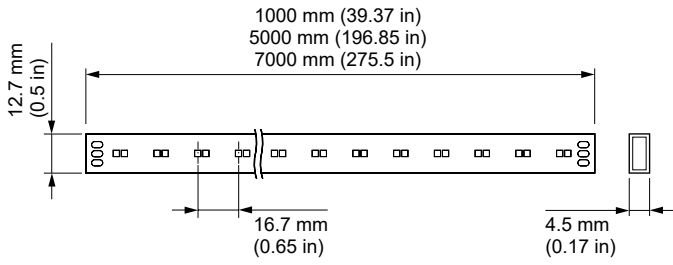

Strip Connector

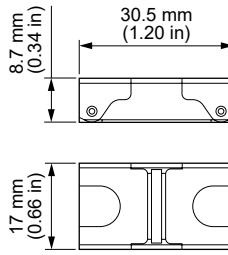

Cable Connector

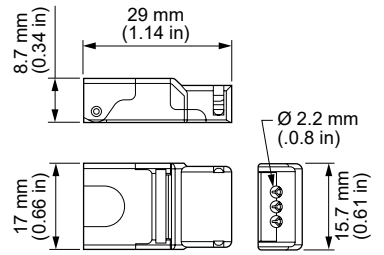

End Cap

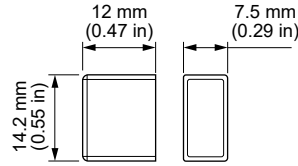

Mounting Clip

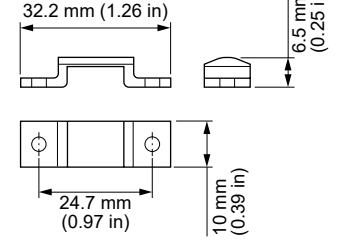

Mounting Track

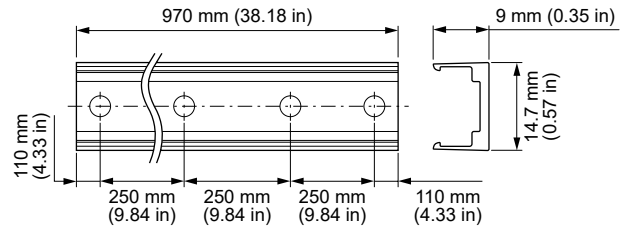

Photometrics 2700 to 6000 K, 0.3 m (1 ft)

Photometric data is based on test results from an independent NIST traceable testing lab. IES data is available at www.colorkinetics.com/support/ies.

Polar Candela Distribution

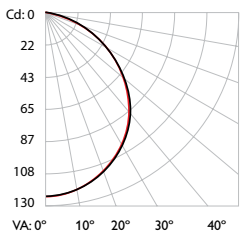

	0	25	45	75	90
0	123	123	123	123	123
5	122	122	122	122	122
15	118	118	118	118	118
25	109	109	109	109	108
35	96	96	96	96	95
45	79	79	79	79	79
55	60	60	60	60	60
65	40	39	39	39	39
75	18	18	18	19	19
85	4	4	4	4	4
90	1	1	1	1	1

■ - 0° H ■ - 90° H

Illuminance at Distance

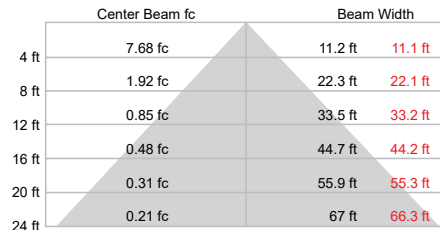

11.1 ft (3.4 m)
1 fc maximum distance

■ Vert. Spread: 108.8°
■ Horiz. Spread: 108.2°

Luminaire and Accessories

Use Item Number when ordering in North America

Luminaire	Item Number	Item 12NC
Vaya Free Form Tunable White, IP40, 2700 to 6000 K, 1 m (3 ft) 4 Mounting clips included.	316-200019-00	912400136482
Accessories		
Mounting Clips, WH/TW (PC) (50 PCS)	320-000019-00	912400136487
Mounting Track, WH/TW (AL), 1 m (3 ft) (10 PCS)	320-000019-01	912400136488
Cable Connector, IP40, WH/TW (10 PCS)	320-000019-02	912400136489
Strip Connector, IP40, WH/TW (10 PCS)	320-000019-03	912400136490
End Cap, IP66, WH/TW (Including RTV Glue) (30 PCS)	320-000020-00	912400136491
Power Supplies		
Philips 100 W 24 V Power Supply (120-240V) CE/ENEC/CB/VDE-EMC/VDE-S/VDE-Household/RCM/CSA/cUL/CCC	-	929001669506
XITANIUM 100 W 24 V Power Supply (120 to 277 V) UL/CSA	309-000001-00	912400130191
XITANIUM 100 W 24 V Power Supply (100 to 240 V) PSE	-	929000485303
Dimming Module		
DMX/Dynet via converter interface	-	913703061209
3rd party PWM controller	-	-

COLORKINETICS vayaseries

© 2020 Signify Holding. All rights reserved. Specifications are subject to change without notice. No representation or warranty as to the accuracy or completeness of the information included herein is given and any liability for any action in reliance thereon is disclaimed.

Color Kinetics
www.colorkinetics.com/global/products/vaya/free-form-tunable/



SPS-0448 REV B

THE ORIGINAL™ INTEGRATED LED SERIES

JOB NAME: _____ FIXTURE TYPE: _____

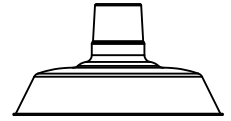

BLE - _____ - _____ - _____ - _____ - _____ - _____ - _____ - _____ - _____

A B C D E F G

_____ - _____ - _____ - _____ - _____ - _____ - _____ - _____ - _____

H I J K L

Order Example: BLE - G - WHS16 - 600 - G22 - 980 - NA - ACR - 600 - NA - LED38 - 2700K - DL

A - MOUNTING STYLE

C	Cord Hung
CN	Chain Hung
F	Flush Mount
G	Gooseneck
S	Stem Mount

B - SHADE SIZE

THE ORIGINAL™:

WHS12 ¹⁰	WHS20 ¹
WHS14	WHS24 ^{1,2,6,10}
WHS16	WHS28 ^{1,2,6,10}
WHS18	

C - SHADE FINISHPORCELAIN FINISHES³:

150	Black
250	White
350	Vintage Green
355	Jadite
455	Cherry Red
550	Yellow
650	Bronze
750	Cobalt Blue
765	Delphite Blue
850	Graphite
950	Metallic Chrome

POWDER COAT FINISHES⁴:

100	Black
105	Textured Black
200	White
300	Dark Green
307	Emerald Green
311	Jadite
370	Mint
380	Chartreuse
390	Teal
400	Barn Red
420	Orange
470	Watermelon
480	Blush Pink
490	Magenta
495	Sherbet Orange
500	Buttery Yellow
570	Sunflower
600	Bronze
601	Chocolate
605	Rust
615	Oil-Rubbed Bronze
700	Royal Blue
705	Navy
710	Cobalt Blue
715	Delphite Blue

C - SHADE FINISH (CONTINUED)POWDER COAT FINISHES⁴:

790	Lavender
800	Industrial Grey
805	Charcoal Granite
810	Graphite
975	Galvanized

NATURAL METALS⁹:

995	Raw Copper
996	Weathered Copper
997	Raw Brass
998	Weathered Brass
999	Oil-Rubbed Copper

D - MOUNTING

Please Note: If Flush Mount [F] is selected in Section A, please select NA

NA	Not Applicable
-----------	----------------

CSA LISTED CORDS:

SBK	Standard Black
SWH	Standard White
CSB	Black Cloth
CSW	White Cloth
CMG	Grey Cloth
CSR	Red Cloth
CRZ	Red Chevron Cloth
CSBB	Black & Brown Cloth
CSRW	Red & White Cloth
CSGW	Gold & White Cloth
CSBG	Black & Gold Cloth
CSBW	Black & White Cloth
CSBP	Black & Pink Cloth
CSUW	Blue & White Cloth

CHAIN MOUNT OPTIONS:

CN36	3' of Chain ¹
CN48	4' of Chain ¹
CN60	5' of Chain ¹
CN72	6' of Chain ¹

GOOSENECK OPTIONS:

G1	G11	G26
G2	G12	G32
G3 ^{1,11}	G13	G34
G4 ¹¹	G14	G35
G5	G15	G36
G6	G16	G64
G7	G17	G65
G8	G22	
G9	G24	
G10	G25	

D - MOUNTING (CONTINUED)

STEM MOUNT OPTIONS:

ST506	.5" Stem Mount, 6" ¹
ST512	.5" Stem Mount, 12" ¹
ST518	.5" Stem Mount, 18" ¹
ST524	.5" Stem Mount, 24" ¹
ST536	.5" Stem Mount, 36" ¹
ST548	.5" Stem Mount, 48" ¹
ST706	.75" Stem Mount, 6" ¹
ST712	.75" Stem Mount, 12" ¹
ST718	.75" Stem Mount, 18" ¹
ST724	.75" Stem Mount, 24" ¹
ST736	.75" Stem Mount, 36" ¹
ST748	.75" Stem Mount, 48" ¹

E - MOUNTING FINISH

Please Note: See Section C for Finish Options. 980-Brushed Aluminum is also available for Gooseneck and Stem mounting styles. If a Porcelain shade finish is selected, mounting will be powder coat painted-to-match. Porcelain shade finishes are not available with a Natural Metal mounting finish

- (I) If Cord Hung [C], selection identifies canopy finish
 (II) If Chain Hung [CN] Mounting Style, selection identifies chain and canopy finish. Natural Metals are not applicable
 (III) If Stem Mount [S] Mounting Style, selection identifies stem and canopy finish
 (IV) If Flush Mount [F] Mounting Style, selection identifies hex coupler and canopy finish. Natural Metals are not applicable

980	Brushed Aluminum
------------	------------------

F - CORDS⁷

NA	Not Applicable
-----------	----------------

Please Note: See Section D for all applicable CSA Listed Cord Options

G - SHADE ACCESSORIES

NA	None
WC	Wire Cage ^{1,12}
ACR	Acrylic Diffuser ⁵

H - SHADE ACCESSORY FINISH

Please Note: See Section C for Finish Options. Natural Metals not applicable with Acrylic Diffuser or Wire Cage. If Porcelain Finish is selected, accessory will be powder coat painted-to-match

NA	Not Applicable
-----------	----------------

I - MOUNTING ACCESSORY

Please Note: Mounting Accessories below are only applicable with select Mounting Styles. Please refer to product listings on our website for further detail.

NA	None/Not Applicable
HSC	Hang Straight Canopy ¹⁹
LDBPC	LED Decorative Backing Plate Cover ¹³
LDCHX	LED Decorative Backing Plate Cover & Hex Cover ¹³

J - LIGHT SOURCE

LED11	850 Lumen, 11W LED
LED16	1250 Lumen, 16W LED
LED27	2000 Lumen, 27W LED
LED38	3000 Lumen, 38W LED
LED43	4000 Lumen, 43W LED ¹⁰

K - COLOR TEMPERATURE

2700K	2700K, Warm White
3000K	3000K, Neutral White
3500K	3500K, Bright White
4000K	4000K, Cool White

L - LED LENS

DL	Domed Lens
FL	Flat Lens

IMPORTANT: (1) Not available in Natural Metals (2) Not available in Porcelain Enamel (3) All Porcelain Enamel finished shades feature a white interior and a black outer rim (4) All Powder Coat finished shades, Galvanized excluded, feature a white interior (5) Acrylic Diffuser limits the maximum lumen selection as well as reduces lumens delivered and LPW. Selection Limits: 2000 Max for 12" and 14" shades; 3000 Max for 16" through 28" shades (6) Wire Cage not available with select size (7) Only applicable if Chain Hung Mounting Style selected in Section A, select NA if another Mounting Style is selected (8) Natural Metals have a longer estimated manufacturing time, please check the website for exact lead time. There are no returns accepted on Natural Metals (9) Only applicable if Stem Mounting Style is selected in Section A (10) Not available with Acrylic Diffuser shade accessory (11) Not compatible with 16" shade size and larger (12) Wire Cage not available for 24" & 28" shade sizes (13) Not available with G36 Gooseneck option

MOUNTING STYLE

HIGH LUMEN CANOPY FOR PENDANT & FLUSH MOUNT

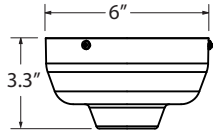

Required if LED 27, 38, 43 Light Source selected in Section J

CHAIN HUNG PENDANT (CN)

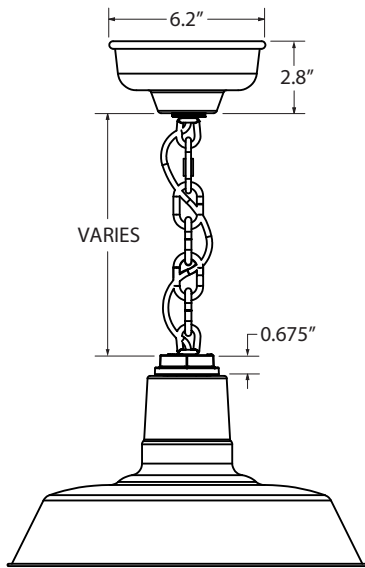

Canopy shown required if LED 11 & 16 Light Source selected in Section J

CORD HUNG PENDANT (C)

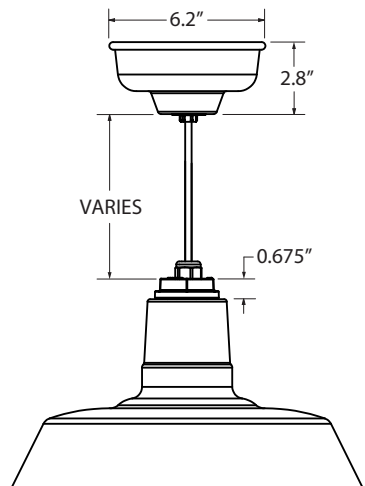

Canopy shown required if LED 11 & 16 Light Source selected in Section J

FLUSH MOUNT (F)

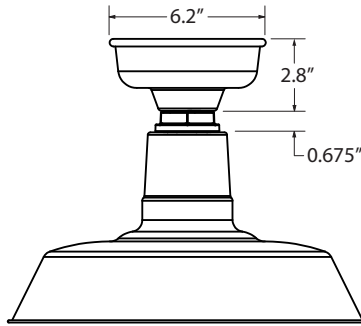

Canopy shown required if LED 11 & 16 Light Source selected in Section J

STEM MOUNT PENDANT (S)

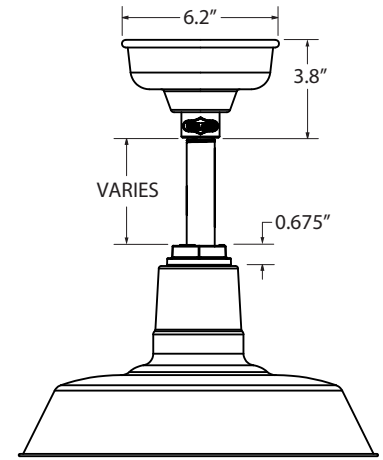

Canopy shown required if LED 11 & 16 Light Source selected in Section J

GOOSENECK (G)

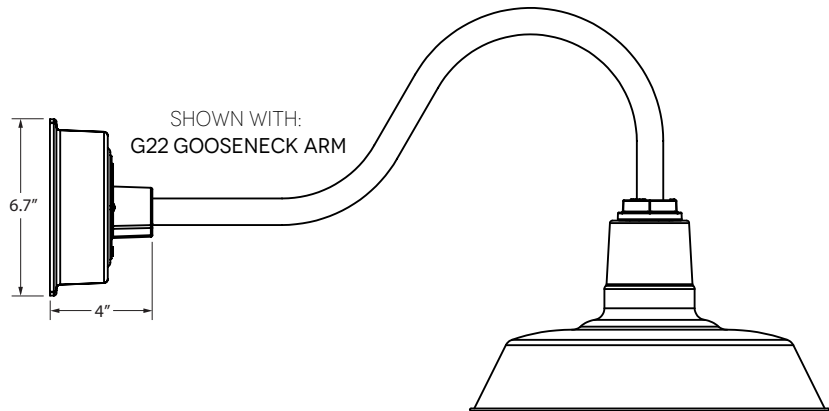

LUMINAIRE DIMENSIONS

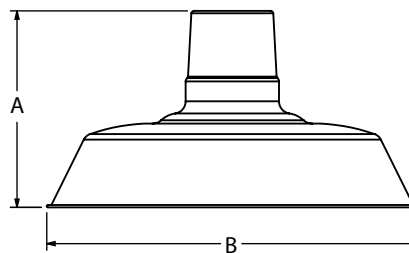

SHADE CODE	HEIGHT (A)	DIAMETER (B)
WHS12	7"	12"
WHS14	7.5"	14"
WHS16	7.75"	16"
WHS18	8.5"	18"
WHS20	9.25"	20"
WHS24	10.75"	24"
WHS28	11"	28"

LIGHT SOURCE

All published luminaire photometric testing performed to IESNA LM-79-08 standards by a NVLAP accredited laboratory. Data is considered to be representative of the configurations shown, within the tolerances allowed by Lighting Facts. To obtain an IES file specific to your project, please contact the factory.

	LUMENS		850		1250		2000		3000		4000	
	Wattage		11		16		27		38		43	
	Optics	Lumens	LPW	Lumens	LPW	Lumens	LPW	Lumens	LPW	Lumens	LPW	
WHS12	FLAT	846	74	1244	78	1997	74	2996	79	3995	93	
	DOMED	824	72	1212	76	1936	72	2904	76	3872	90	
WHS14	FLAT	845	74	1243	77	1982	73	2973	78	3964	92	
	DOMED	823	72	1210	75	1904	71	2856	75	3808	88	
WHS16	FLAT	845	74	1243	77	1982	73	2973	78	3964	92	
	DOMED	822	72	1209	75	1902	70	2854	75	3805	88	
WHS18	FLAT	843	74	1240	77	1978	73	2967	78	3956	92	
	DOMED	819	72	1204	75	1895	70	2843	75	3791	88	
WHS20	FLAT	841	74	1237	77	1973	73	2959	78	3945	91	
	DOMED	815	72	1199	75	1887	70	2830	74	3773	87	
WHS24	FLAT	838	74	1233	77	1968	73	2952	77	3936	91	
	DOMED	810	71	1191	74	1877	70	2815	74	3753	87	
WHS28	FLAT	840	74	1235	77	1974	73	2961	78	3948	92	
	DOMED	811	71	1193	74	1885	70	2828	74	3771	87	

*Acrylic Diffuser option reduces lumens delivered and LPW

LIGHT DISTRIBUTION

DOMED LENS (DL)

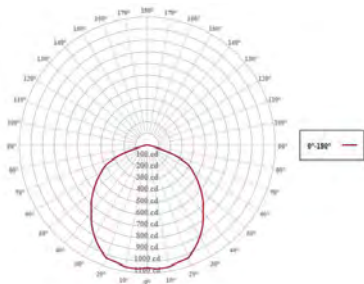

Shown above with 16" Shade (WHS16), White Interior (200-White) and 3000 Lumen (LED38)

FLAT LENS (FL)

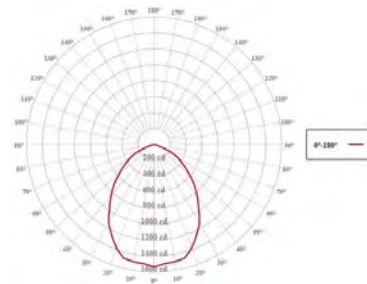

Shown above with 16" Shade (WHS16), White Interior (200-White) and 3000 Lumen (LED38)

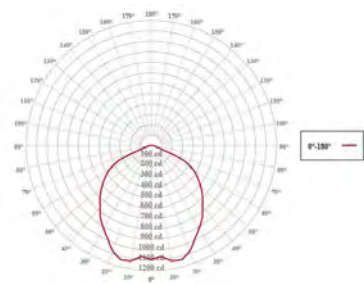

Shown above with 20" Shade (WHS20), White Interior (200-White) and 3000 Lumen (LED38)

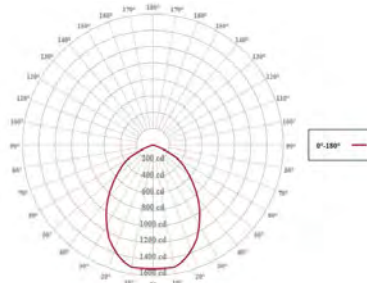

Shown above with 20" Shade (WHS20), White Interior (200-White) and 3000 Lumen (LED38)

SPECIFICATIONS

LED 11, 16, 27, 38, 43 LIGHT SOURCE

LED TYPE: CREE LMH2 MODULE
 INITIAL LUMENS DELIVERED: UP TO 4000 LUMENS
 L90(6K) > 36,300 HOURS
 AVAILABLE CCT: 2700K, 3000K, 3500K, 4000K
Custom Temperatures Available upon Request
 90+ CRI
 2 STEP MACADAMS ELLIPSE
 EFFICACY: UP TO 93 LPW
High Efficacy Available upon Request, Consult Factory for Additional Information

DIMMING

LED 11 & 16
**Triac Dimming at 100-120VAC, Able to Dim down to 5%.
 Dependent on Specific Dimmer.
 0-10V & ELV Dimming Available upon Request.**
 LED 27, 38 & 43
**0-10V Dimming, Able to Dim down to 10%.
 Dependent on Specific Dimmer.
 Triac & ELV Dimming Available upon Request.**
 TRIAC & ELV DIMMING AT 230 VAC
Available by Request
 COMPATIBLE DIMMERS
Consult Factory for Additional Information on Dimming

LED 27, 38, 43 ELECTRICAL/LED DRIVER

DRIVER TYPE: LMD400 DRIVE CURRENT: 940mA
 POWER FACTOR > 0.95 EFFICIENCY: UP TO 81% TYPICAL
 INPUT VOLTAGE: 120-277 VAC (SEE DIMMING SECTION)
 CLASS 2 POWER SUPPLY
 LED DRIVER LIFETIME: > 50,000 HOURS (@ 25 DEG C AMBIENT)
 CONDUCTED AND RADIATED EMI
Compliant with FCC CFR Title 47 Part 15 Class B (120 VAC), Class A (277 VAC) and EN55015 (CISPR 15) at 230 VAC

CERTIFICATIONS, LISTINGS & WARRANTY

MADE IN THE USA
**Manufactured and Hand-Crafted in Our 60,000 Square Foot Facility
 Located in Titusville, FL**
 CSA LISTED FOR WET LOCATIONS
Includes All Gooseneck, Stem and Flush Mounting Styles
 CSA LISTED FOR DAMP LOCATIONS
Includes All Chain and Select Cord Hung Mounting Styles
 LIMITED WARRANTY
**For Additional Information on Our Limited Warranty, Please See
 Our Terms & Conditions**
 OPERATING TEMPERATURE
 -30°C to 40°C

LED 11, 16 ELECTRICAL/LED DRIVER

DRIVER TYPE: LMD125
 DRIVE CURRENT: 440mA
 POWER FACTOR > 0.9
 EFFICIENCY: UP TO 81% TYPICAL
 INPUT VOLTAGE: 100-120 VAC (SEE DIMMING SECTION)
 CLASS 2 POWER SUPPLY
 LED DRIVER LIFETIME: > 50,000 HOURS (@ 25 DEG C AMBIENT)
 CONDUCTED AND RADIATED EMI
Compliant with FCC CFR Title 47 Part 15 Class B (120 VAC), Class A (277 VAC) and EN55015 (CISPR 15) at 230 VAC

SHADE & FINISHES

POWDER COAT SHADE
**Hand-Spun from High Purity 0.050" Thick 3003-O Temper
 Aluminum**
 PORCELAIN SHADE
Hand-Spun from 20 Gauge Sheet Metal
 POWDER COAT FINISHES
**Polyester Powder Coat Finishes Are Electro-Statically Applied and
 Thermocured**
 PORCELAIN FINISHES
Applied by Hand and Fired in a High Temperature Oven
 COPPER
Hand-Spun from High Purity .032 Thick C11000-O60 ETP Copper
 BRASS
Hand-Spun from High Purity .050" Thick C2600-O60 Brass

MOUNTING

STEM
**1/2" Nominal (0.84" Actual) or 3/4" Nominal (1.05" Actual) Sch 40,
 6063 Aluminum Mounting Stem. Custom Lengths Available upon
 Request.**
 GOOSENECK
**1/2" Nominal (0.84" Actual) or 3/4" Nominal (1.05" Actual) Sch 40,
 6063 Aluminum Gooseneck**
 CORD
**Cord-Hung Pendants Include 7' of Standard Cord or 5' of Cloth
 Cord, +/- For Socket Orientation**
 CHAIN
**4-Gauge Chain Complete with Quick Link for On-Site Adjustments
 to Chain's Length**
 MAX FIXTURE WEIGHT
10 lbs



TELLURIDE FIRE PROTECTION DISTRICT

Scott Heidergott, Fire Marshal

Address: Lot 226 BR
Mountain Village, CO 81435

Architect: Stillwater Architecture

- 1) Transitional sections may be allowed a maximum grade of up to 12%, providing all structures served by the access road are equipped with a monitored sprinkler system meeting the requirements of NFPA 13, 13D or 13R determined by the occupancy.
- 2) The address monument shall be minimum 4'6" from grade to the bottom of the address numbers. Address numbers shall be 6" in height, reflective coated or outlined with a reflective coating.
- 3) TFPD recommends the installation of a Knox Box for access during emergency situations.

Review comments by TOMV staff forester, Michael Otto

1. New Single Family Home at 87 Pennington Place

https://townofmountainvillage.com/site/assets/files/34813/lot_729r-7_referral_packet.pdf

“ALL NEW LANDSCAPE MATERIAL WILL BE PLACED AND MAINTAINED TO COMPLY WITH THE REQUIREMENTS OF SECTION 17.6.1 PARAGRAPH 3 SUBPARAGRAPH D.”

Planned conifer plantings on the preliminary landscape plan are in Zone 1.

The preliminary landscape plan does not determine the revegetation seed ratio and does not list conifer or shrub species to be planted as described in Section 17.5.9. Without a plan for species and size of conifer and shrub planting it is not possible to determine if diversity, size, and native planting requirements will be met.

2. New Single Family Home at 122 Singletree Road

https://townofmountainvillage.com/site/assets/files/34814/lot_ar26_referral_packet.pdf

Concern over the use of conifers as a screen on the NW side of the building as zone 1 is not extended into the neighboring property. However, I recommend moving forward with the landscape plan as a low steel wall is also planned for the building on the same side and the neighboring property is not heavily forested.

I am also concerned with the use of horizontal juniper species in the landscape plan. Juniper shrubs are especially flammable, however, use of conifer shrubs in landscaping is not strictly prohibited by the community development code wildfire mitigation guidelines. Additionally, common juniper is the only native conifer shrub species listed in the cdc guidelines. Other more common conifer landscape shrubs would not meet naturalized planting guidelines.

3. New Single Family Home at 242 Benchmark Drive

https://townofmountainvillage.com/site/assets/files/34815/lot_226br_referral_packet.pdf

Chokecherry is not listed in the diversity clause of landscape planting. However, it is not used as often as aspen and blue spruce. I would recommend viewing the use of chokecherry trees as meeting the diversity clause.

Dogwood trees do not meet naturalized planting requirements. Only one specific native dogwood shrub is listed on the naturalized planting list. Most dogwood trees are considered to be limited to hardiness zone 5 and up and generally have high water requirements. Mountain Village can be considered zone 4 or 5 and has dry spells. Extra consideration should be given to the species and microclimate. Harsh conditions in winter or summer may limit the longevity of

planted dogwood. Pagoda dogwood is zone 3, but has high water requirements. Amur maple and Tatarian maple are good ornamental alternatives listed on the native plantings requirement table.

John A. Miller

From: GiGi Gerlach <gigi@prideandjoypropmgmt.com>
Sent: Friday, April 16, 2021 9:44 AM
To: John A. Miller
Cc: Tom Rastin; Karen Wright; Kurt Schisler; Bret Jones; PJPM Office Manager
Subject: Proposed Development Lot

Dear Mr. Miller,

Please find attached the owners of 284 Benchmark Drive response to the proposed development of MV Lot226BR. We request the opportunity for this to be submitted with the DRB packets.

Sincerely,

GiGi Gerlach

President

Pride & Joy Property Management, Inc.

P.O. Box 3214

Telluride, CO 81435-3214

[\(970\) 728-9637](tel:(970)728-9637)

[\(970\) 728-8644](tel:(970)728-8644) fax

[\(970\) 729-0559](tel:(970)729-0559) cell

gigi@prideandjoypropmgmt.com



From: Tom Rastin <tomrastin@hotmail.com>
Sent: Friday, April 16, 2021 9:29 AM
To: GiGi Gerlach <gigi@prideandjoypropmgmt.com>
Cc: Karen Wright <kwright@arielcorp.com>; George Harvey <george@theharveyteam.net>; Kurt Schisler <Kurt@hfmltd.com>; Bret Jones <bret@prideandjoypropmgmt.com>; PJPM Office Manager <office@prideandjoypropmgmt.com>
Subject: Re: please review II for 284 benchmark!

Hi Gigi,

Looks good, let's proceed and thank you for having our back.

Tom

TomRastin@Hotmail.com

Join The Empowerment Alliance

www.empoweringamerica.org

On Apr 16, 2021, at 11:12 AM, GiGi Gerlach <gigi@prideandjoypropmgmt.com> wrote:

To Whom It May Concern of Mountain Village Design and Review Board:

On behalf of Karen Wright, Tom Rastin and their an incredibly close knit family of fourteen members who enjoy the peace and solitude of their private Halcyon Mountain home, which resides at 284 Benchmark Drive. Your acceptance for input is greatly appreciated and we trust that this Initial Hearing will be one of many to address the neighborhood concerns. Having been their sole property managers for 11 years, they have requested a letter communicating their concerns for the proposed development of Lot 226BR (242 Benchmark Drive). There are serious considerations on multiple fronts of this dynamic proposed project.

To begin with the fundamentals of Benchmark Drive addresses, as you may be aware of, the addresses of 248, 252, 280 and 284 Benchmark are on a spur which is privately maintained. These four addresses are not in numeric order for Benchmark, as they come after 246 Benchmark yet before 250 Benchmark. Packages, shuttles, furniture deliveries are lost or delayed constantly. Deliveries from further up Benchmark are also made to our homes when delivery agents are unfamiliar with the road lack of sequence. Many cars turn on this spur and turn around in all of these driveway, including across Halcyon Mountains private bridge, into our privacy simply because the addresses routinely confound so many people. Other cars and trucks simply use this entrance to the spur, as an easy access area to turn around, some backing up blind onto Benchmark to correct their course.

The proposed development of 242 Benchmark is also not in the proper order, as the proposal of the driveway is to come between 244 and 246 Benchmark. This will put an undo strain on our privately maintained road, without the municipalities support to repair the asphalt or clear the snow, this burden falls on 280 and 284 Benchmark, as it is understood. Please consider the driveway easement to be relocated to the north of 244 Benchmark to reduce the unwarranted use of driveways and private roads being torn up by more befuddled souls. This section of Benchmark is already chaotic and this lower address placed between two higher sequenced homes will further compound the matter in such a short distance.

Regarding the proposed design, the gravest concern is related to the covered parking that is exposed on three sides with a roof design that mimics a covered open air stage, creating an amphitheater effect on all of the homes that reside uphill (246, 248, 252, 280 and 284 Benchmark). Simply having a car running or doors closing will echo up through the denuded building site on to our patios and in through our windows. The open air parking noise also has nowhere to go other than out to this home and others. This noise will easily join the acoustics of the carport and may also radiate out and might include 244 and 246 Benchmark even more.

Additionally, the carport opening to the ski run will not only resemble that of a parking garage but will allow head lights to cross over the landscape, including the Galloping Goose ski run and illuminating the night landscape and sky from our main living areas and bedrooms. It appears that the home across the way, which we believe to be 110 Snowdrift will be directly impacted by the car head lights and thus appear nightly in Halcyon Mountains views whenever someone uses the carport and parking at Lots 226BR.

Finally the elevated drive and parking area will have little landscape or buffer to reduce the noise of people, motors and tires from radiating out off of this hardscape of the rigid walls that surround it on two sides. The elevational application of lights will also be much higher, impacting the neighboring view corridor, being masked by little as it permeates the surrounding properties, especially in the winter months.

Please understand new neighbors are a welcome gift to the community. By highlighting these matters now, we trust a responsible, respectful and reduced impact to the neighboring homes, views and roadways may be reached. If you have any questions related to these points, please feel free to contact me at the information list below. Thank you for your time

Sincerely,
GiGi Gerlach
President
Pride & Joy Property Management, Inc.
P.O. Box 3214
Telluride, CO 81435-3214
[\(970\) 728-9637](tel:(970)728-9637)
[\(970\) 728-8644](tel:(970)728-8644) fax
[\(970\) 729-0559](tel:(970)729-0559) cell
gigi@prideandjoypropmgmt.com

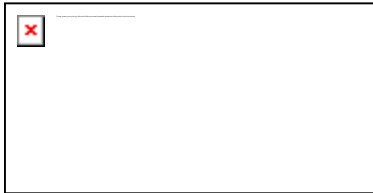

John A. Miller

From: Olga Kramar <olga.kramar@alumni.stanford.edu>
Sent: Monday, April 12, 2021 12:50 PM
To: cd
Subject: Proposed lot subdivision at 242 Benchmark Dr, lot 226BR

We bought our home at 233 Benchmark for the character of the neighborhood, and the fact that it was an established neighborhood, not one under development. The area surrounding our home is as important as the home itself, as any real estate agent will tell you. Established neighborhoods provide substantial benefits, as follows:

1. Peace and quiet. No empty lots around us gave some assurance we wouldn't be subjected to extended noise and disruption from a new build. New construction brings noise and traffic. As it turned out, those of us living on Benchmark have spent two years dealing with super-loud jake brakes (ask me for videos) and speeding worker trucks, many from Oprah's project. Our repeated requests to stop either were barely answered, and no effort was made to remedy the problems. We have no confidence that either speed limits, parking prohibitions, or noise from dump trucks would be mitigated. So another peaceful summer and winter or two or three destroyed by a new build right up the street?
2. No surprise new houses. Since there are no empty yet-to-be-developed lots in our immediate area, we counted on no new oversized houses that block or alter a view., whether directly from our house, or from the immediate surroundings.
3. This area has many log homes with a mostly rustic character. The home pictured is completely out of character for the neighborhood.
4. Housing density is key. Every house now has a given amount of space around it. That's one of the features we bought. We hike the ski runs multiple times a day during the summer. The forest and vegetation along the ski run are wonderful, not just for us but all those who hike the runs. Why start turning it into a row of large, looming, houses? Everyone wants a slope-side house, so allowing this will set a precedent that will snowball. If you ever enjoyed the beach at Destin, FL in the 70s and then went back today, with the outrageous development density, you understand. If Mountain Village starts to allow subdividing lots into smaller parcels, what's to stop many other landowners deciding to make a buck by splitting their land? How will you deny future parcel subdivisions if you allow this one? This will lead to completely destroying the character of Mountain Village.

I strongly oppose the proposed lot subdivision and new house construction.

Please also count this as my request to speak and the online meeting addressing this subject.

Regards,
Olga

--

Olga Kramar | 281.639.8890
3500 E Lincoln Drive, Unit 45
Phoenix, AZ 85018

John A. Miller

From: Steve Rosenblatt <steverosenblatt1@gmail.com>
Sent: Monday, April 12, 2021 12:48 PM
To: cd
Subject: Lot 226BR and 242 Benchmark Lot Subdivision

My wife, Olga Kramar and I are located at 233 Benchmark across the street from the proposed project. We are opposed to this lot subdivision and construction of a two story home of nearly 6000 square feet for multiple reasons.

We have endured endless construction traffic on Benchmark due to Oprah's massive project for a very long time. Despite multiple calls to MVPD there has been no law enforcement of speeding or jake brake violations of large dump and cement trucks. We do not want to intensify construction traffic on Benchmark nor do we want the noise that a massive construction project of nearly 6000 square feet of air conditioned space will bring. That is one reason.

Another reason is that we bought 233 Benchmark with an existing home density in mind. This project increases the density, dwarfs the ski slope with a structure closer to the edge of the ski run than existing homes and will set in motion greed driven subdivisions into the future with the creation of more flag shaped lots. Perhaps, the owners are intending to build a huge house to move into and perhaps turn the existing home into yet another AirBnB. This project will hopefully require the owners to justify their request for variances. I see no compelling reason presented in the proposed plan to make a driveway retaining wall 5' tall instead of the maximum allowable 4'. Perhaps the problem is the lot is not big enough in the needed places to build a massive home and/or driveway.

For the most part the lower end of Benchmark has smallish homes and the larger homes are on larger lots way up Benchmark near its upper end. Again, the character of lower Benchmark would be visibly changed from the street and slope side of this property.

I note further that the owners or their representatives had to know that notices to neighbors would go out seeking support or opposition to the project and yet no effort was made to preliminarily contract the nearby homeowners before application to the town was submitted. Maybe because the homes in that part of Benchmark are traditional or log homes and not one comes across as Mountain Modern as per the submitted drawings in the application. Perhaps the owners of the project hoped neighbors would not pay attention and negative input to the town would be avoided. Perhaps the owners thought that neighbor input is a mere formality to endure to build the project. I hope they are wrong on both counts. A good neighbor would have contacted neighbors to reveal the project rather than having neighbors have to hear of it from the formal application process. We suggest the owners buy a proper lot to build their dream project, just like Oprah did, We are vigorously in opposition to this project for the above reasons.

We wish to testify virtually on April 22, 2021 and consider this email our request to register to be able to speak live at the virtual hearing where we hope to see at least one of the owners and not merely their legal or architectural representatives. Please provide a Zoom link for the meeting or a URL to the agenda that includes such a link.

Steve Rosenblatt

Cell/Office 609 922 1482

Members of the Design and Review Board:

My name is Casey Cates and I write to you representing the interests of 246 Benchmark Drive, Mountain Village. I want to, first, thank all of you for your time and consideration in addressing our concerns regarding the proposed development at 242 Benchmark Drive (Lot 226BR), Mountain Village. Our first notice of the proposed development was received just 2 days ago; therefore, we feel we have much to learn regarding the proposed development and respectfully reserve the right to addend this document and our concerns as we obtain more information. That being said, we have enough information to raise serious concerns about the development at 242 Benchmark Drive (Lot 226BR).

Before articulating our concerns about the actual structure proposed and construction involved to build said property, I am curious to know the following:

1. If the address for proposed house is 242 Benchmark Drive, why isn't the proposed driveway north of 244 Benchmark Drive? It is logical to assume the developers of Mountain Village intended for the driveway for Lot 226BR to be between 240 Benchmark Drive and 244 Benchmark Drive considering it has the address of 242 Benchmark Drive.
2. Is there a previous history of proposed development on Lot 226BR? If so, what were the reasons for the development not coming to fruition and/or being denied by previous Design and Review Boards? Are those same reasons still pertinent and present today?

The remainder of our concerns will focus on the negative impact the proposed property has on 246 Benchmark Drive. These concerns are based on the architectural and engineering plans for the proposed property.

Aesthetics

- the carport and accompanying driveway are elevated and require a 5' retaining wall along the entire length of our home and much of our property
- the enormous carport looks like a parking lot and is contrary to a "mountain feel"
- the location and design of their carport has no consideration to minimize the "eyesore" on surrounding neighbors
- the required removal of mature trees will destroy the current feeling of being in a forest while enjoying our property

Privacy

- the required removal, and likely loss of trees on our property will have serious deleterious effects on our privacy in 4/6 of our bedrooms
- our entire outdoor living area will be affected (the current deck was a \$250,000 recent addition)
- due to the raised carport and driveway, privacy while in our hot tub is essentially destroyed

Noise and Light Pollution

- the carport design creates an amphitheater that will project all noise (vehicle and people) directly at our home and outdoor living area
- the curve and elevation of the driveway/carport causes headlights exiting the property to project directly at our outdoor living area and 4/6 bedrooms
- the positioning of the home/carport on the lot maximizes the negative impact of lighting on our home and outdoor living area

Safety

- due to the raised, curved driveway and proximity to our house, any vehicle accidentally driving off the driveway has the potential to launch directly into our bedrooms on the north side of our home
- due to the raised driveway and proximity to our house and outdoor living area, snow/pea gravel removal is a concern for our safety when outside and for our windows (the entire driveway needs to be heated to avoid this danger)

Construction

- how long is the proposed project going to take?
- who is responsible for keeping area neat and clean?
- are the owners prepared to compensate us for lost trees on our property from construction of driveway in such close proximity to our home? (we will have an arborist advise us on the potential impact and replacement cost)
- the replacement of destroyed trees cannot occur on the ski path (where are they going to plant them?)

As members of the Design and Review Board, I am sure our concerns are not unique or new to you. Our hope is that our concerns will be properly addressed and a solution to each of them offered and executed with our input. Although we are not opposed to the building of the home on Lot 226BR, we are adamantly opposed to the current design of the driveway, carport and positioning of the house on the lot. The design is so flawed they are asking for a special request from the DRB to exempt them from the 4'-0" maximum stepped wall requirement. We look forward to hearing your thoughts on our concerns and working with you to resolve any and all issues regarding this proposed development.

Sincerely,

The Cates and Hattendorf family



AGENDA ITEM 4
PLANNING & DEVELOPMENT SERVICE
PLANNING DIVISION
455 Mountain Village Blvd.
Mountain Village, CO 81435
(970) 728-1392

TO: Mountain Village Design Review Board
FROM: John Miller, Senior Planner
FOR: Design Review Board Public Hearing; June 10, 2021
DATE: May 26, 2021
RE: Staff Memo – Final Architecture Review, Lot 424, 121 Touchdown Dr.

APPLICATION OVERVIEW:

PROJECT GEOGRAPHY

Legal Description: Lot 424, Telluride Mountain Village, Filing 12
Address: 121 Touchdown Drive
Applicant/Agent: Chris Hawkins, Alpine Planning
Owner: Salter Family Partners LTD, a Texas LTD
Zoning: Single-Family
Existing Use: Single-Family
Proposed Use: Single-Family
Lot Size: 2.012 AC

Adjacent Land Uses:

- **North:** Single-Family
- **South:** Single-Family
- **East:** Single-Family
- **West:** Single-Family

ATTACHMENTS

Exhibit A: Applicant Narrative
Exhibit B: Architectural Plan Set
Exhibit C: Referral Comments



Figure 1: Vicinity Map

Case Summary: Chris Hawkins of Alpine Planning, Applicant for Lot 424, is requesting Design Review Board (DRB) approval of the Final Architecture Review (FAR) Application for a residential addition at 121 Touchdown Drive. The Lot is approximately 2.012 acres and is zoned Single-Family. The overall existing square footage of the home is currently 7,847 square feet and this proposal would increase that floor area by 2,777.3 for a total of 10,624.3 square feet. Due to the overall size of the addition, this application is required to obtain a Class 3 approval by the DRB. This item's Final Review was continued from the

November 5, 2020 Hearing, where the DRB requested that the applicant revise the drawings to ensure the proposed addition was better grounded. This item was continued for a number of months due to the required redesign and COVID-19 pandemic and at this point has resubmitted the required materials and updated drawings per the provisions of Section 17.4.11 of the Community Development Code (CDC) for a Class 3 DRB Final Architecture Review.

Applicable CDC Requirement Analysis: The applicable requirements cited may not be exhaustive or all-inclusive. The applicant is required to follow all requirements even if an applicable section of the CDC is not cited. *Please note that Staff comments will be indicated by italicized Text.*

<u>CDC Provision</u>	<u>Requirement</u>	<u>Proposed</u>
Maximum Building Height	40' (gable) Maximum	34.33'
Maximum Avg. Building Height	35' (gable) Maximum	23.92'
Maximum Lot Coverage	30%	9.17%
General Easement Setbacks	No encroachment	None outside of allowable
Roof Pitch		
Primary		10:12
Secondary		8:12, 3.25:12
Exterior Material (addition)		
Stone	35% minimum	35.4%
Windows/Doors	40% maximum	14.1%
Parking	2 enclosed / 2 exterior	3/2

Design Review Board Specific Approval:

1. GE Encroachment – Excavation and Shoring

Chapter 17.3: ZONING AND LAND USE REGULATIONS

17.3.12: Building Height Limits

Sections 17.3.11 and 17.3.12 of the CDC provide the methods for measuring Building Height and Average Building Height, along with providing the height allowances for specific types of buildings based on their architectural form. The proposed design incorporates Gabled roof forms which are granted a maximum building height of 40 feet. The maximum average height must be at or below 35 feet for gable roof forms. The average height is an average of measurements from a point halfway between the roof ridge and eave. The points are generally every 20 feet around the roof. The maximum height is measured from the highest point on a roof directly down to the existing grade or finished grade, whichever is more restrictive.

Staff: The applicant has provided a Building Height Analysis on submitted page A1.5 which demonstrates both Maximum Building Height and Maximum Average Building Height as being compliant with the CDC. In addition, they have provided a parallel plane analysis also demonstrating compliance.

17.3.14: General Easement Setbacks

Lot 424 is burdened by a sixteen (16) foot General Easement (GE) which surrounds its perimeter. The CDC provides that the GE and other setbacks be maintained in a natural, undisturbed state to provide buffering to surrounding land uses. The CDC does provide for some development activity within the GE and setbacks such as Ski Access, Utilities,

Address Monuments, and Fire Mitigation. All encroachments not listed above typically require encroachment agreements between the property owner and the Town.

Staff: There are no proposed encroachments into the GE as part of this addition. Because the majority of the home is existing, the typical GE encroachment discussion related to items such as address monuments does not apply to this request.

There will be minor disturbances to the GE related to construction and any disturbances other than fire mitigation work will be required to be returned to their original pre-disturbed condition. This is particularly important on the Southern GE where the retaining wall is directly adjacent to the GE.

Chapter 17.5: DESIGN REGULATIONS

17.5.4: Town Design Theme

The Town of Mountain Village has established design themes aimed at creating a strong image and sense of place for the community. Due to the fragile high alpine environment, architecture and landscaping shall be respectful and responsive to the tradition of alpine design – reflecting elements of alpine regions while blending influences that visually tie the town to mountain buildings. The town recognizes that architecture will continue to evolve and create a regionally unique mountain vernacular, but these evolutions must continue to embrace nature and traditional style in a way that respects the design context of the neighborhoods surrounding the site.

Staff: The DRB requested modifications to the proposed addition at the FAR hearing in November, and the applicant has redesigned based on that feedback. Although the design of the home has changed slightly, the material palette has remained the same consisting of stone, wood, and metal which appears to fit well with the Town's Design Theme requirements. Although the addition is slightly more modern than the existing home, it does appear to blend well with the existing timber-based log architecture. With that being said, the addition does appear to fit architecturally and demonstrates a good example of additions having been designed to represent the architectural time period that it was constructed.

The applicant has proposed horizontal log siding to complement the existing portions of the home but has chosen a metal palette of vertical steel siding, steel panels, and standing seam roofing materials. It appears based on the applicant's submittal that the material palette for the project blends well with both the surrounding community, as well as the overall modern mountain vernacular that is very popular recently within Mountain Village.

17.5.5: Building Siting Design

The CDC requires that any proposed development blend into the existing landforms and vegetation.

Staff: Due to the pre-existing nature of the home, the addition appears to be logically sited on the lot. Although this does involve the disturbance of steep slopes as documented in the applicant's submittal, it also appears to meet the goals of the owner for preservation of existing uses, views, access, etc. Additionally, this location provides much more screening than would be otherwise available in other locations.

17.5.6: Building Design

Staff: The CDC requires that building form and exterior wall forms portray a mass that is thick and strong with a heavy grounded foundation. The prior design featured a large, cantilevered portion of the home that the DRB discussed in detail and determined that

they did not find it grounded. With that, the applicant has revised to plans so that the entirety of the homes footprint is grounded with stone foundation elements in a much more traditional alpine design that previously seen. The proposal meets the 35% requirement for stone. As documented briefly above, the proposed siding is a mixture of vertical steel and log siding.

Window trim is proposed as dark metal clad and the doors appear to be largely glass. The proposed roofing material is a light grey bonderized standing seam. The CDC allows for black and grey standing seam roofing materials and this appears to meet that requirement. According to the material calculation sheet, the fascia and soffits are to be wood, and the garage door is proposed to be metal.

The applicant has proposed new snowmelt areas for the home at 480 square feet, and it should be noted that any cumulative snowmelt areas totaling over 1000 square feet may be subject to energy off-set fees.

17.5.7: Grading and Drainage Design

Staff: The applicant has provided a revised grading and drainage plan demonstrating areas of disturbance, drainage patterns, and driveway details. On this plan, it has been indicated that the areas surrounding the home will not be disturbed and/or the grades of these areas will be undisturbed. It is not likely that the areas will remain undisturbed throughout construction but will be remediated to have the same finished grade as the pre-disturbed grade.

17.5.8: Parking Regulations

Staff: The CDC requires all single-family developments to provide two interior and two exterior parking spaces. The applicant has shown compliant existing interior and exterior spaces and is proposing on additional interior space within the addition which complies with the CDC requirements.

17.5.9: Landscaping Regulations

The applicant has provided a landscaping plan but has generally avoided additional plantings given the extend of the mature landscaping surrounding the home. Since the last review, the applicant has revised the plans to remove the previous earthen roof element and is now proposing a play courtyard in this area. I will note that staff is assuming that this will be turf in this area but it is otherwise not specified within the landscaping plan. The applicant as a condition of approval shall provide additional landscaping details as it relates to the addition.

17.5.11: Utilities

Staff: NA – utilities are already at existing home.

17.5.12: Lighting Regulations

Staff: Due to the age of the home, a majority if not all of the existing light fixture on the home must be retrofitted to meet current CDC requirements. The DRB requested at IASR that the applicant update their lighting plan to demonstrate the existing and proposed fixtures as well as to provide a photometric study of the property. The applicant has provided the requested analysis of both within the revised plan set, but it should be noted that the non-compliant fixtures may not be retrofitted with frosted glass as suggested by the applicant as that does not meet the requirements of the CDC. The applicant will be required to replace any non-conforming fixture with a conforming fixture as part of this project. Staff is recommending the DRB require a condition as part of any approval that requires the applicant to revise the lighting plan to replace the non-compliant fixtures

identified to be retrofitted with frosted glass with lighting that entirely meets the requirements of the CDC. This plan should be reviewed by staff and a member of the DRB prior to the issuance of a building permit.

17.5.13: Sign Regulations

Staff: No proposed changes to the address monument.

Chapter 17.6: SUPPLEMENTARY REGULATIONS

17.6.1: Environmental Regulations

Staff: Fire Mitigation and Forestry Management: The applicant has provided a fire mitigation plan for the property including a tree survey, identification of zones 1 and 2, and specific treatments to occur in zone 2. Staff is requesting the DRB condition any approval requiring the applicant to work with the Town Forester for the implementation of the Fire Mitigation plan per the CDC requirements.

Steep Slopes: The proposed addition does impact steep slopes, but it appears that this location is the most logical on the site due to the pre-existing nature of the home.

17.6.6: Roads and Driveway Standards

Staff: The Civil Drawings indicate that the driveway will require slight modifications but will generally remain the existing location. Otherwise, the driveway meets the requirements of the CDC.

17.6.8: Solid Fuel Burning Device Regulations

Staff: The applicant has indicated that the proposed addition does include a natural gas burning fireplace.

Chapter 17.7: BUILDING REGULATIONS

17.7.19: Construction Mitigation

Staff: The applicant has submitted a CMP as part of this application. Staff supports the proposal with the note that any areas of the General Easement to be utilized shall be returned to the pre-disturbed condition before the project's issuance of a certificate of occupancy. The applicant has not indicated a crane will be necessary for this project and if it is determined that it will be required, the applicant will at that point be required to update their CMP. Additionally, all construction fencing to the downhill side of the area of disturbance is required to also have silt fencing and/or other methods of stormwater protection. The applicant as a condition of approval shall provide an updated CMP to the Building Official as part of the building permit plan set.

Staff Recommendation: Staff recommends the DRB approve the Final Architecture Review for Lot 424, 121 Touchdown Drive.

Staff Note: *It should be noted that reasons for approval or rejection should be stated in the findings of fact and motion.*

Proposed Motion:

If the DRB deems this application to be appropriate for approval, Staff requests said approval condition the items listed below in the suggested motion.

I move to approve the Final Architecture Review for a Class 3 Residential Addition located at Lot 424, 121 Touchdown Drive, based on the evidence provided within the Staff Memo of record dated May 26, 2021, with the following conditions:

- 1) Prior to issuance of a Building Permit, the applicant shall revise their CMP to include stormwater and erosion control devices on the downhill sides of the area of disturbance.
- 2) Prior to issuance of a Building Permit, the applicant shall revise their lighting plan for approval by staff and a member of the DRB, to demonstrate that the non-compliant lighting fixtures have been revised to meet the current lighting requirements of the CDC.
- 3) Prior to the issuance of a building permit, the applicant shall revise the landscaping plan per the comments within this staff memo of record. This plan shall be reviewed by the Town Forester for compliance with the CDC, and the Town Forester will be required to issue a tree removal permit for any trees to be removed as part of the approved landscaping plan.
- 4) Consistent with town building codes, Unenclosed accessory structures attached to buildings with habitable spaces and projections, such as decks, shall be constructed as either non-combustible, heavy timber or exterior grade ignition resistant materials such as those listed as WUIC (Wildland Urban Interface Code) approved products.
- 5) Prior to the submittal for Building Permit, the applicant shall verify cumulative square footage of all areas of external snowmelt with the Building Department– if applicable.
- 6) The applicant shall revegetate any disturbed areas of the General Easement to its pre-disturbed condition prior to the finalization of the Building Permit.
- 7) A monumented land survey shall be prepared by a Colorado public land surveyor to establish the maximum building height and the maximum average building height.
- 8) A monumented land survey of the footers will be provided prior to pouring concrete to determine there are no encroachments into the GE.
- 9) Prior to the Building Division conducting the required framing inspection, a four-foot (4') by eight-foot (8') materials board will be erected on site consistent with the review authority approval to show:
 - a. The stone, setting pattern and any grouting with the minimum size of four feet (4') by four feet (4');
 - b. Wood that is stained in the approved color(s);
 - c. Any approved metal exterior material;
 - d. Roofing material(s); and
 - e. Any other approved exterior materials

/jjm

John A. Miller

From: Jim Boeckel <jim@telluridefire.com>
Sent: Thursday, August 27, 2020 12:15 PM
To: John A. Miller
Subject: Re: Class 3 Referral - Addition to existing home @ Lot 424, 121 Touchdown Drive

John, Addition shall have a fire sprinkler system installed along with smoke and CO detection to comply with applicable codes, statutes, and standards. The fire sprinkler system may be an addition to the existing system as can the new required detectors.

On Wed, Aug 26, 2020 at 7:20 PM John A. Miller <JohnMiller@mtnvillage.org> wrote:

Hey Everyone,

This is a class 3 addition of about 3k square feet. No changes to the existing home other than roof replacement to standing seam. Let me know if you have any questions or concerns.

https://townofmountainvillage.com/site/assets/files/33792/iasr_addition_lot_424_121_touchdown_drive.pdf

Thanks,

J

John A Miller III, CFM

Senior Planner

Planning & Development Services

Town of Mountain Village

455 Mountain Village Blvd, Suite A

Mountain Village, CO 81435

O :: 970.369.8203

C :: 970.417.1789



For information about The Town of Mountain Village's response to COVID-19 (Coronavirus), please visit townofmountainvillage.com/coronavirus/

From: John A. Miller

Sent: Wednesday, July 22, 2020 11:51 AM

To: Finn KJome <FKJome@mtnvillage.org>; Steven LeHane <SLeHane@mtnvillage.org>; Jim Loebe <JLoebe@mtnvillage.org>; Chris Broady <CBroady@mtnvillage.org>; 'jim.telfire@montrose.net' <jim.telfire@montrose.net>; 'jeremy@smpa.com' <jeremy@smpa.com>; 'brien.gardner@blackhillscorp.com' <brien.gardner@blackhillscorp.com>; 'kirby.bryant@centurylink.com' <kirby.bryant@centurylink.com>; 'jim@telluridefire.com' <jim@telluridefire.com>

Subject: Class 3 Referral - New Home at Lot 630, Double Eagle Drive

Hey again everyone,

Below you will find a link to a proposed new home to be located at Lot 630, TBD Double Eagle Drive. This lot is just past the golf cart path if you're traveling downhill from Russell Drive.

<https://townofmountainvillage.com/site/assets/files/33679/ondr-drb1.pdf>

Let me know if there are any questions or concerns.

Thanks,

J

John A Miller III, CFM

Senior Planner

Planning & Development Services

Town of Mountain Village

455 Mountain Village Blvd, Suite A

Mountain Village, CO 81435

O :: 970.369.8203

C :: 970.417.1789



For information about The Town of Mountain Village's response to COVID-19 (Coronavirus), please visit townofmountainvillage.com/coronavirus/

--

Jim Boeckel, Fire Marshal, Battalion Chief

Telluride Fire Protection District
PO Box 1645/131 West Columbia Avenue
Telluride, CO 81435

[970-729-1454](tel:970-729-1454) (cell)

[970-728-3801](tel:970-728-3801) (office)

[970-728-3292](tel:970-728-3292) (fax)

jim@telluridefire.com



LOT COVERAGE & FLOOR AREA CALCULATIONS		
STANDARDS	ALLOWED	PROPOSED
LOT COVERAGE		
GROSS LOT AREA (S.F. AND ACREAGE)	< 30% LOT COVERAGE	2.012 ACRES= 87,642.72 s.f. MAX COVERAGE= 26,292.82 s.f. COVERAGE SF= 8,660.6 s.f. COVERAGE %= 9.88%
LOT COVERAGE	< 30%	(9.88% IS 20.12% BELOW THE ALLOWABLE 30%)
FLOOR AREA CALCULATIONS		
		SEE SHEET A1.4 FOR ALL AREA CALCULATIONS
MISC REQUIREMENTS		
BUILDING SETBACKS	16'	16'
BUILDING HEIGHT		
- MAXIMUM	- 35' (+5' EXCEPTION)	- 39.58'
- AVERAGE	- 30'	- 24.99'
NUMBER OF UNITS BY TYPE	- 1 RESIDENTIAL	- 1 RESIDENTIAL
PARKING SPACES		
- ENCLOSED	- 2 ENCLOSED	- 1 ENCLOSED
- SURFACE	- 2 SURFACE	- 1 SURFACE
SNOWMELT AREA	- SEE MECHANICAL	- SEE MECHANICAL
EXTERIOR MATERIALS	- SEE A3 SERIES	- SEE A3 SERIES
CODE SUMMARY		
ZONING - SINGLE FAMILY RESIDENTIAL BUILDING CODE - IRC-2012 DESCRIPTION - 2.0 STORY WITH BASEMENT OCCUPANCY CLASSIFICATION - IRC 1&2 AUTOMATIC FIRE SPRINKLERS - NFPA 13D- SPRINKLERED GREATER THAN 3,600 S.F. FIRE RESISTIVE RATING SHAFT ENCLOSURES - 1 HR. EXIT ENCLOSURE RATING 1 HR. ELEVATOR SHAFT 2 HR.		



SITE CONTEXT

Sheet List	
Sheet Number	Sheet Name
A0.0	COVER SHEET
A0.1	SURVEY
A0.2	SLOPE STUDY
A0.3	RENDERINGS
C1	NOTES
C2	GRADING AND DRAINAGE PLAN
A0.4	SITE PHOTOS
A0.5	PERSPECTIVES
A0.6	OVERALL PERSPECTIVES
A1.0	OVERALL SITE PLAN
A1.1	EXISTING SITE PLAN
A1.2	SITE AND LANDSCAPE PLAN
A1.3	CONSTRUCTION MITIGATION PLAN
A1.4	FLOOR AREA AND SITE COVERAGE
A1.5	BUILDING HEIGHT COMPLIANCE ANALYSIS
A1.6	EXTERIOR MATERIAL CALCULATIONS
A2.0	LOWER LEVEL
A2.1	MAIN LEVEL
A2.2	ROOF PLAN
A2.5	MAIN LEVEL REFLECTED CEILING PLAN
A2.6	UPPER LEVEL REFLECTED CEILING PLAN
A3.0	EXTERIOR MATERIALS
A3.1	EXTERIOR ELEVATIONS
A3.2	EXTERIOR ELEVATIONS
A3.3	EXTERIOR ELEVATIONS
A3.4	OVERALL ELEVATIONS
A4.0	BUILDING SECTIONS
A9.1	WINDOW AND DOOR SCHEDULES
S1.1	FOUNDATION PLAN
S1.2	FIRST FLOOR FRAMING
S1.3	SECOND FLOOR FRAMING
S1.4	ROOF FRAMING
M1.0	MECHANICAL SCHEDULES, DESIGN CONDITIONS, HYDRONIC ZONES
M2.0	LEVEL 01 & 02 MECHANICAL
LT1.0	SITE LIGHTING PLAN
LT1.01	SITE LIGHTING PLAN
LT1.1	EXTERIOR LIGHTING PLAN
LT5.1	EXISTING LIGHTING IMAGES
LT5.2	EXISTING LIGHTING IMAGES
LT5.3	EXISTING LIGHTING IMAGES
LT7.1	LIGHTING SCHEDULE

FUTURE HERS REPORT

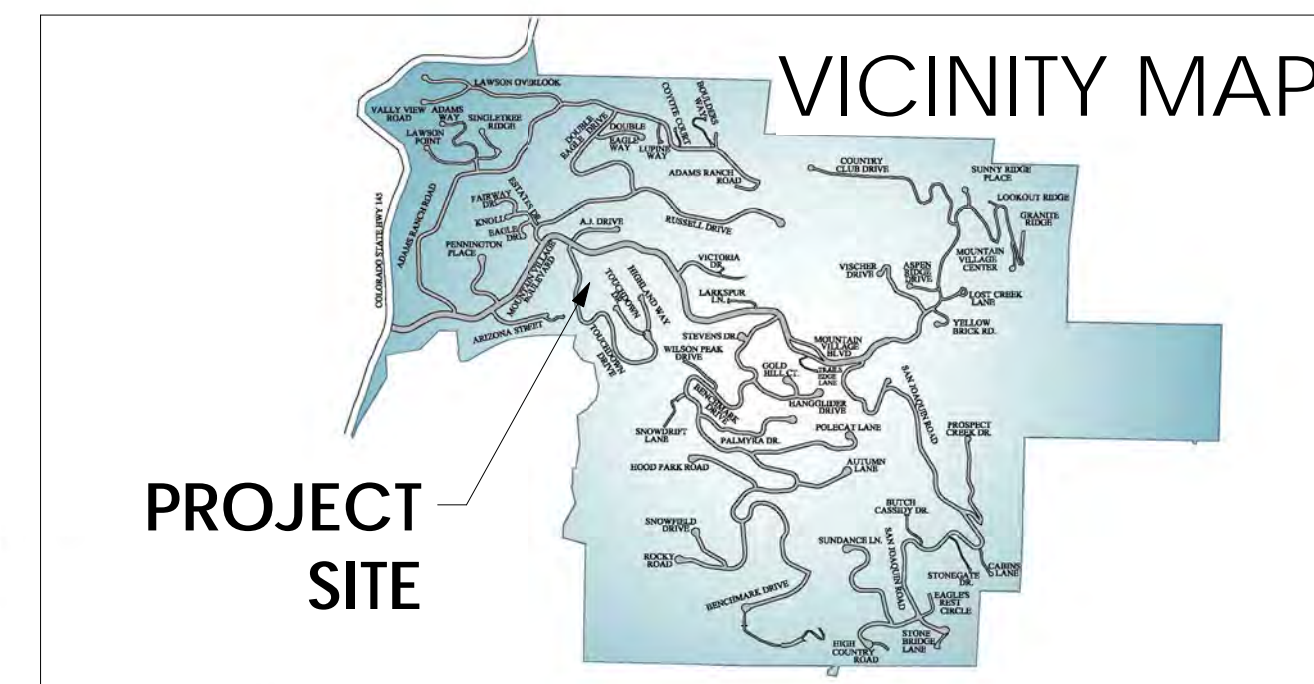
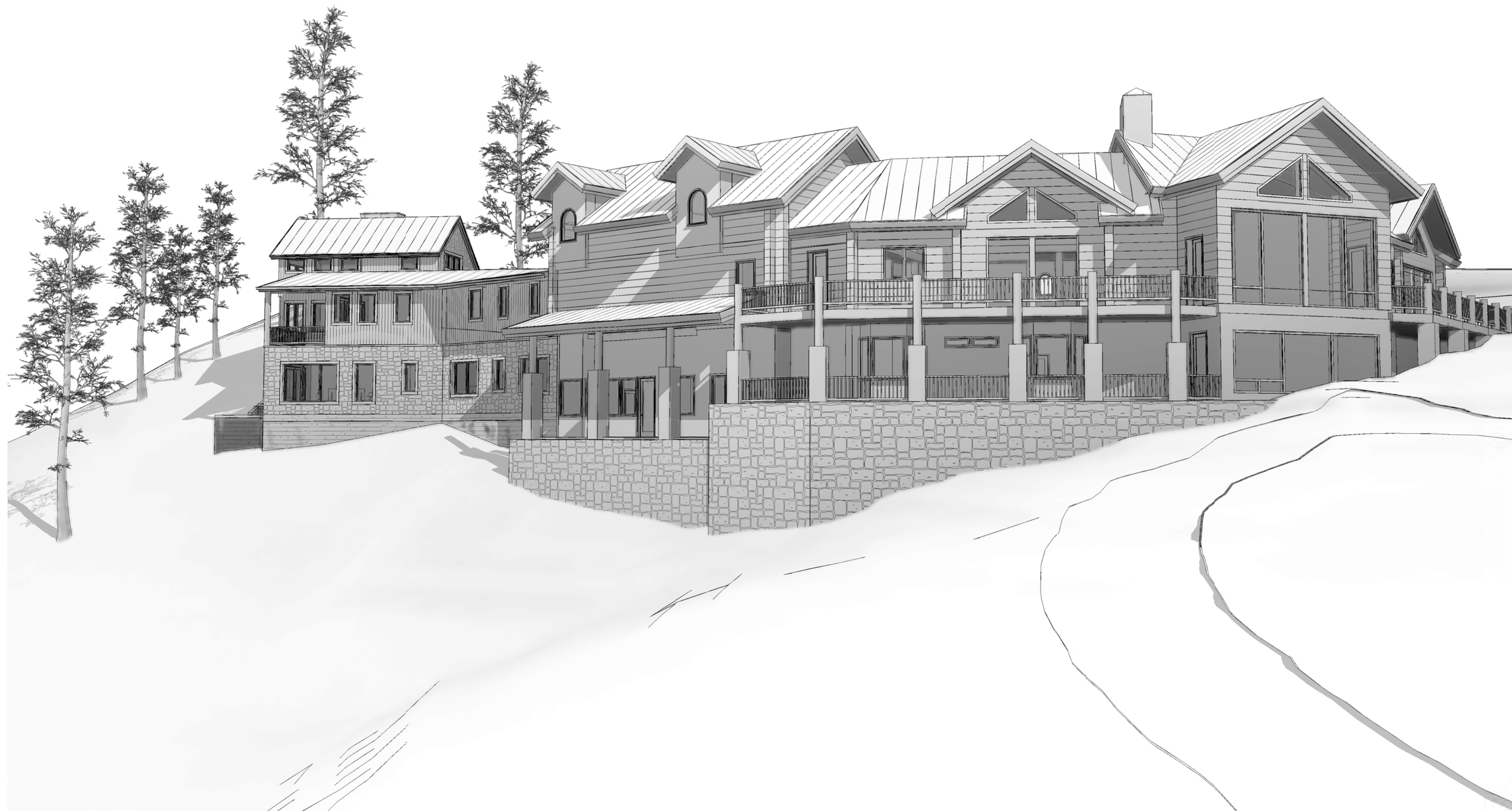

PROJECT SITE

VICINITY MAP

PROJECT TEAM

OWNER:
PATRICK & CARLY LATCHAM/SALTER
c/o TOMMY HEIN ARCHITECTS

ARCHITECT:
TOMMY HEIN ARCHITECTS
TOMMY HEIN
108 S. OAK ST - P.O. BOX 3327
TELLURIDE, CO 81435
p. 970.728.1220 f. 970.728.1294
TOMMY@TOMMYHEIN.COM

PROJECT PLANNER:
ALPINE PLANNING, LLC
CHRIS HAWKINS
P.O. BOX 654
RIDGWAY, CO 81432
p. 970.964.7927
CHRIS@ALPINEPLANNINGLLC.COM

CONTRACTOR:
TBD

INTERIORS:
TBD

LANDSCAPE:
TBD

CIVIL:
UNCOMPAGRE ENGINEERING, LLC
DAVID BALLODE, P.E.
P.O. BOX 3945
TELLURIDE, CO 81435
970.729.0683
DBALLODE@MSN.COM

STRUCTURAL:
COLORADO STRUCTURAL
MIKE ARBANEY
315 BELLEVUE, SUITE 2B
P.O. BOX 2544
CRESTED BUTTE, CO 81224
970.349.5922
MIKE@COLORADOSTRUCTURAL.COM

MECHANICAL, ELECTRICAL, PLUMBING:
HUGHES CONSULTING ENGINEERING
DIMITRI MERRILL
220 W. COLORADO AVE.
TELLURIDE, CO 81435
p. 970.239.1949
DIMITRI@HCE-PA.COM

LIGHTING:
ROBERT SINGER & ASSOCIATES INC.
KIM QUINT
P.O. BOX 8929
ASPEN, CO 81621
p. 970.963.5692 f. 970.963.5684
RSINGER@ROBERTSINGERLIGHTING.COM
KQUINT@ROBERTSINGERLIGHTING.COM

SURVEYOR:
ALL POINTS LAND SURVEY LLC
TOM CLARK
PO BOX 754
OPHIR, CO 81435
p. 970.708.9694
ALLPOINTSLANDSURVEY@GMAIL.COM

REGULATORY COMPLIANCE
THE CONTRACTOR SHALL ENSURE THAT THE WORK AND CONSTRUCTION ADMINISTRATION PROCESSES COMPLY WITH ALL APPLICABLE GOVERNMENTAL AND PRIVATE REGULATIONS, INCLUDING BUT NOT LIMITED TO THE TOWN OF TELLURIDE LAND USE CODE (LUC), DESIGN GUIDELINES, HISTORIC AND ARCHITECTURAL REVIEW COMMISSION (HARC) CONDITIONS, CERTIFICATES OF APPROPRIATENESS (CAs) AND IMPACT STATEMENTS, THE TOWN OF MOUNTAIN VILLAGE COMMUNITY DEVELOPMENT CODE (CDC) AND DESIGN REVIEW BOARD (DRB) CONDITIONS, SAN MIGUEL COUNTY BUILDING REGULATIONS AND ALL COVENANTS, CONDITIONS & RESTRICTIONS, DECLARATIONS, ARCHITECTURAL GUIDELINES AND RULES AND REGULATIONS ESTABLISHED BY ANY PRIVATE OWNERS ASSOCIATIONS THAT GOVERN THE PROJECT SITE

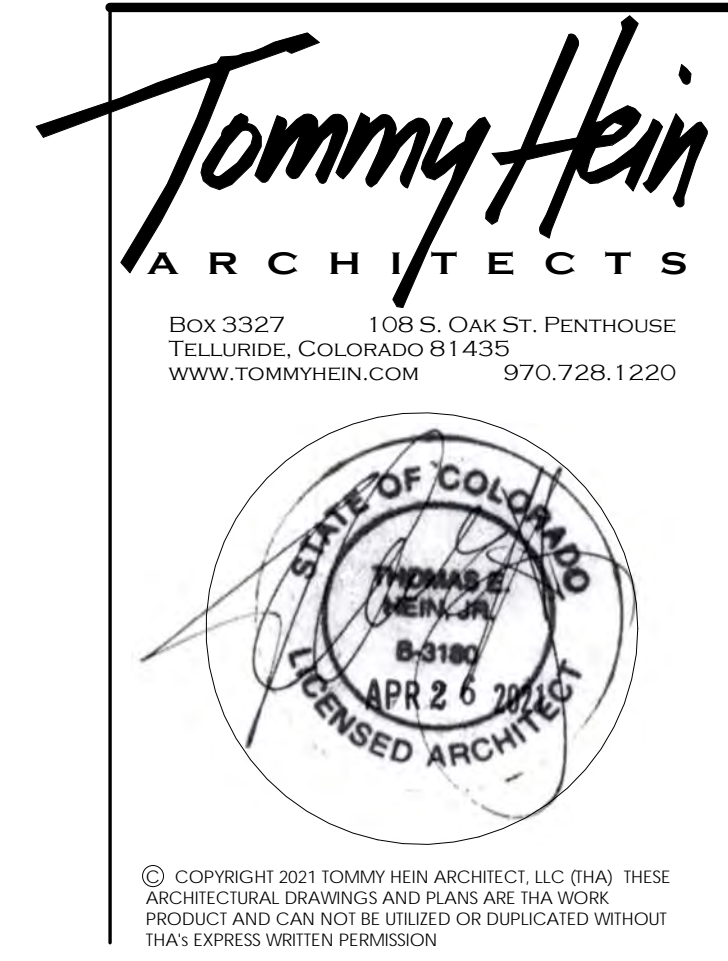

Submissions

DRB REVIEW	20.08.06
PRICING SET	20.08.24
TAGS & SCHEDS	20.09.08
DRB FINAL REVIEW	20.09.24
CHECK SET	21.04.15
DRB RE-REVIEW SET	21.04.26



ADDITION

LOT 424
121 TOUCHDOWN
DR., MOUNTAIN
VILLAGE

COVER SHEET

CONTRACTOR TO REVIEW AND COMPARE ALL CHAPTERS AND INTERDISCIPLINARY DRAWINGS AND REPORT ANY DISCREPANCIES TO THE ARCHITECT PRIOR TO ANY FIELD WORK BEING DONE IN ACCORDANCE WITH AIA DOCUMENT A201

A0.0

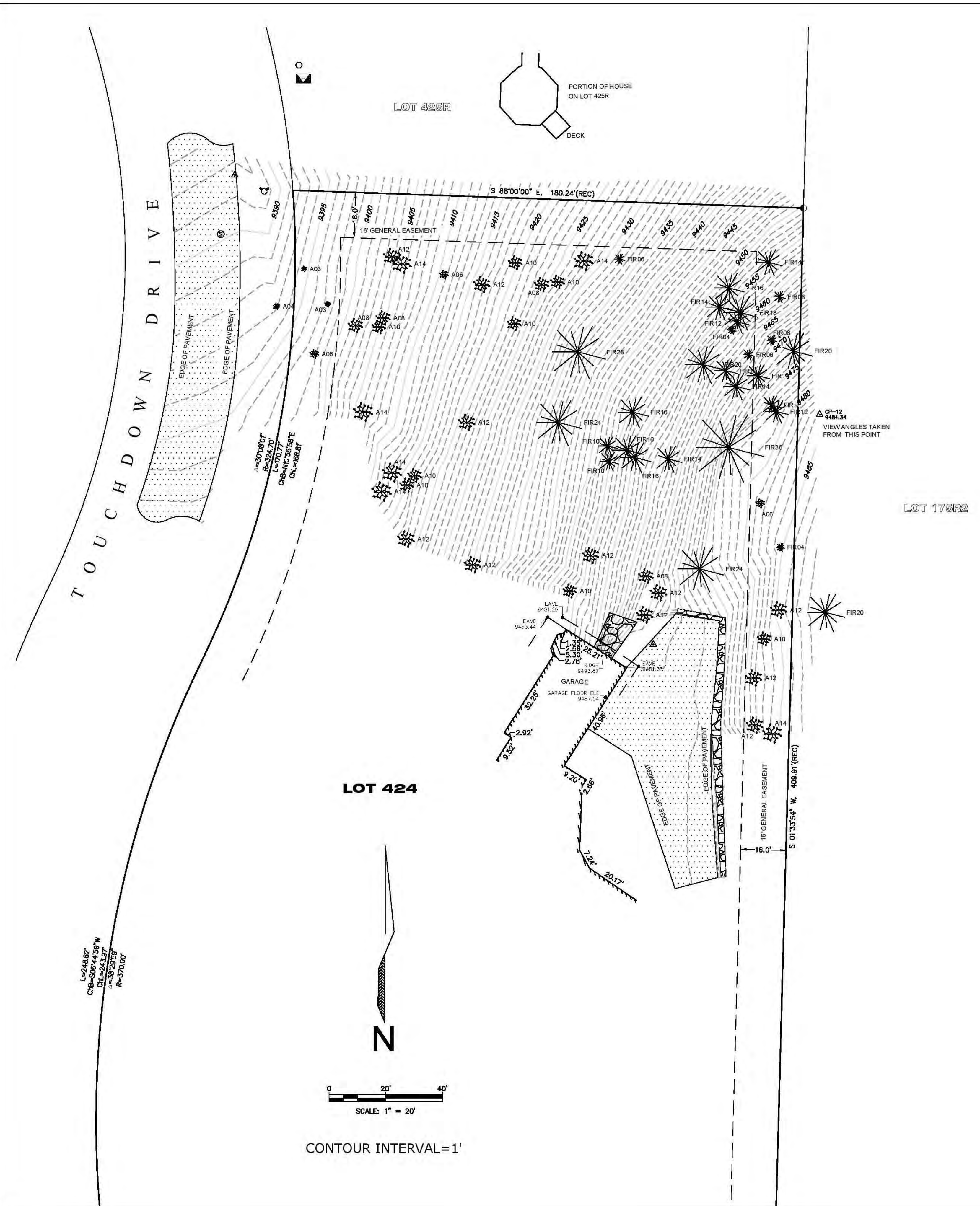

PROPERTY DESCRIPTION:

LOT 424, FILING NO. 12, MOUNTAIN VILLAGE,
 COUNTY OF SAN MIGUEL,
 STATE OF COLORADO.

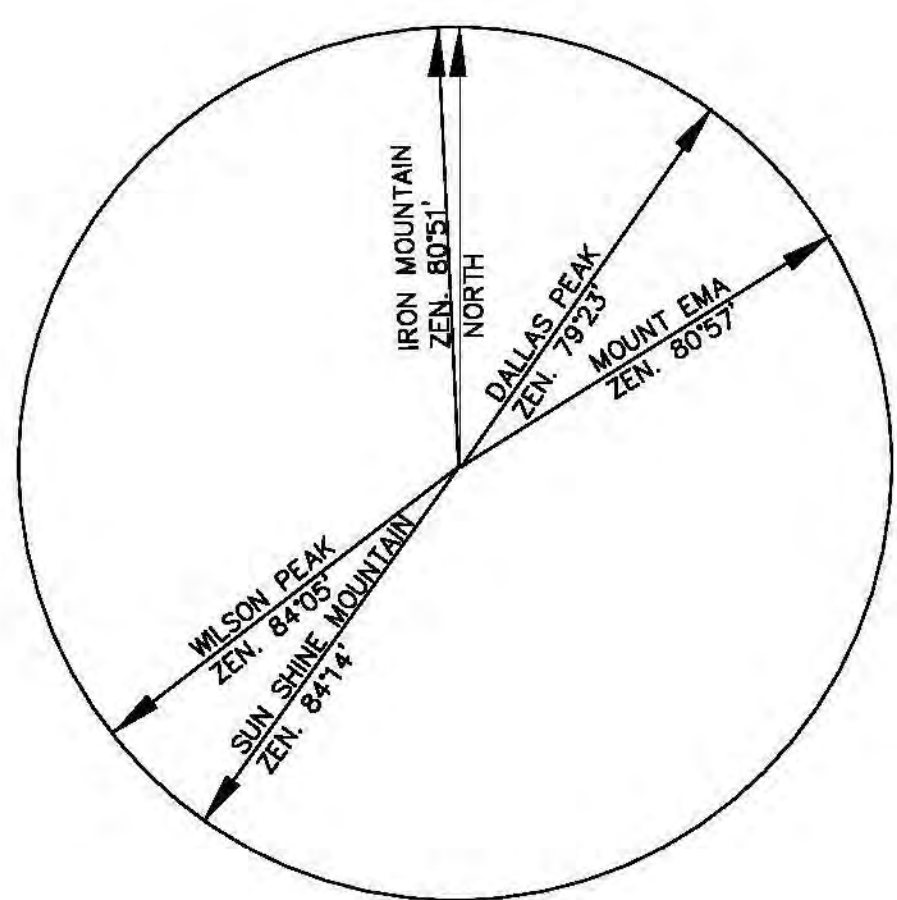

VIEW ANGLES
 ANGLES ENUMERATED
 ARE ZENITH ANGLES

SURVEYOR'S CERTIFICATE:

I, Thomas A. Clark, being a Colorado Licensed Land Surveyor, do hereby certify that this Topographic Survey of a portion of Lot 424, Mountain Village was made by me and under my direct supervision, responsibility, and checking. This Topographic Survey does not constitute a Land Survey Plat or Improvement Survey Plat as defined by Title 38, Article 51 C.R.S.

Thomas A. Clark
 Thomas A. Clark PLS. 38014
 COLORADO LICENSED LAND SURVEYOR
 3/6/2021

NOTES:

1. Field work was performed on February 2020.
2. Elevation datum for this survey is based on the garage floor elevation as depicted topographic map dated 2/27/01 on that elevation being 9767.54.
3. This survey is valid only if a printed or electronic copy has a seal and signature of the surveyor noted within the statement above.
4. NOTICE: According to Colorado law you must commence any legal action based upon defect in this survey within three years after you first discover such defect. In no event may any action based upon any defect in this survey be commenced more than ten years from the date of the certification shown hereon.
5. Due to winter conditions ground features that were not visible may not be shown.

LEGEND:

- PAVEMENT
- FOUND #5 REBAR WITH 1 1/2" ALUMINUM CAP LS 24954 SURVEY CONTROL POINT
- TRANSFORMER
- TELEPHONE PEDESTAL
- SEWER MAN HOLE
- FIRE HYDRANT

TREE CHART

- SPRUCE TREE WITH TRUNK DIAMETER INDICATED IN INCHES
- FIR TREE WITH TRUNK DIAMETER INDICATED IN INCHES
- ASPEN TREE WITH TRUNK DIAMETER INDICATED IN INCHES

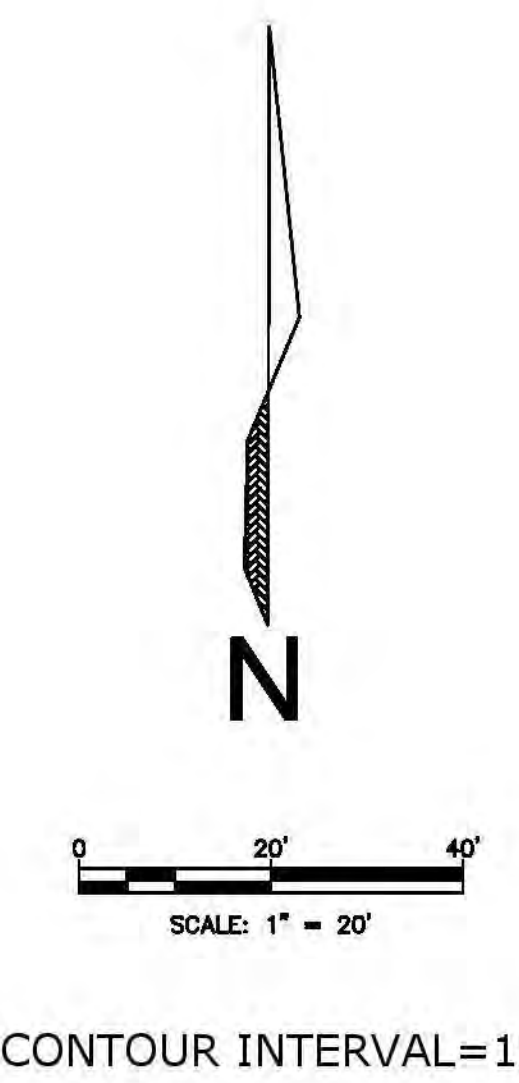

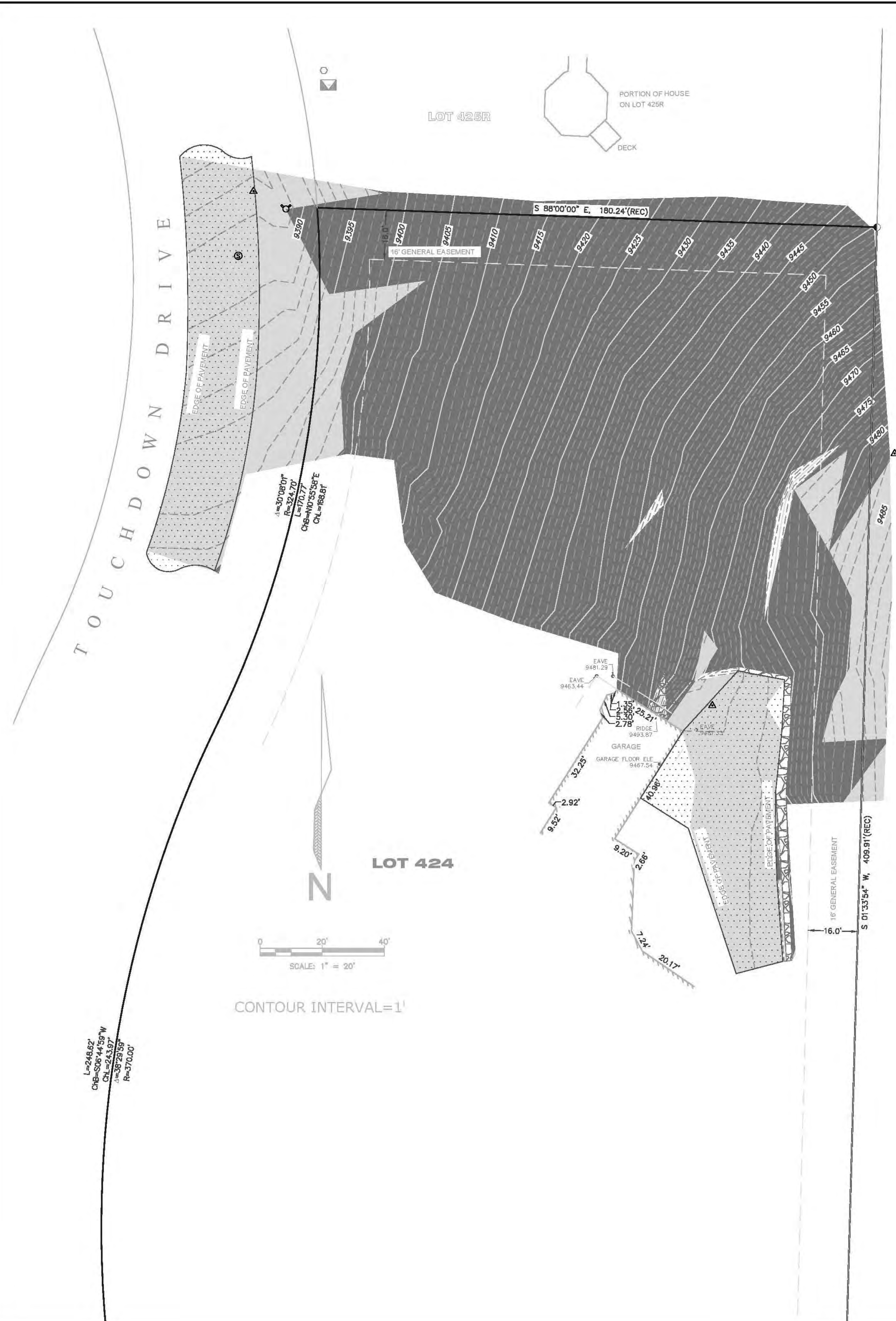

PROPERTY DESCRIPTION:

LOT 424, FILING NO. 12, MOUNTAIN VILLAGE,
 COUNTY OF SAN MIGUEL,
 STATE OF COLORADO.

SURVEYOR'S CERTIFICATE:

I, Thomas A. Clark, being a Colorado Licensed Land Surveyor, do hereby certify that this Topographic Survey of a portion of Lot 424, Mountain Village was made by me and under my direct supervision, responsibility, and checking. This Topographic Survey does not constitute a Land Survey Plat or Improvement Survey Plat as defined by Title 38, Article 51 C.R.S.







Thomas A. Clark PLS. 38014

NOTES:

- Field work was performed on February 2020.
- Elevation datum for this survey is based on the garage floor elevation as depicted topographic map dated 2/27/01 on that elevation being 9767.54.
- This survey is valid only if a printed or electronic copy has a seal and signature of the surveyor noted within the statement above.
- NOTICE: According to Colorado law you must commence any legal action based upon defect in this survey within three years after you first discover such defect. In no event may any action based upon any defect in this survey be commenced more than ten years from the date of the certification shown hereon.
- Due to winter conditions ground features that were not visible may not be shown.

SLOPE TABLE			
NUMBER	MIN. SLOPE	MAX. SLOPE	COLOR
1	0.001%	29.999%	
2	30.001%	90.000%	

LEGEND:

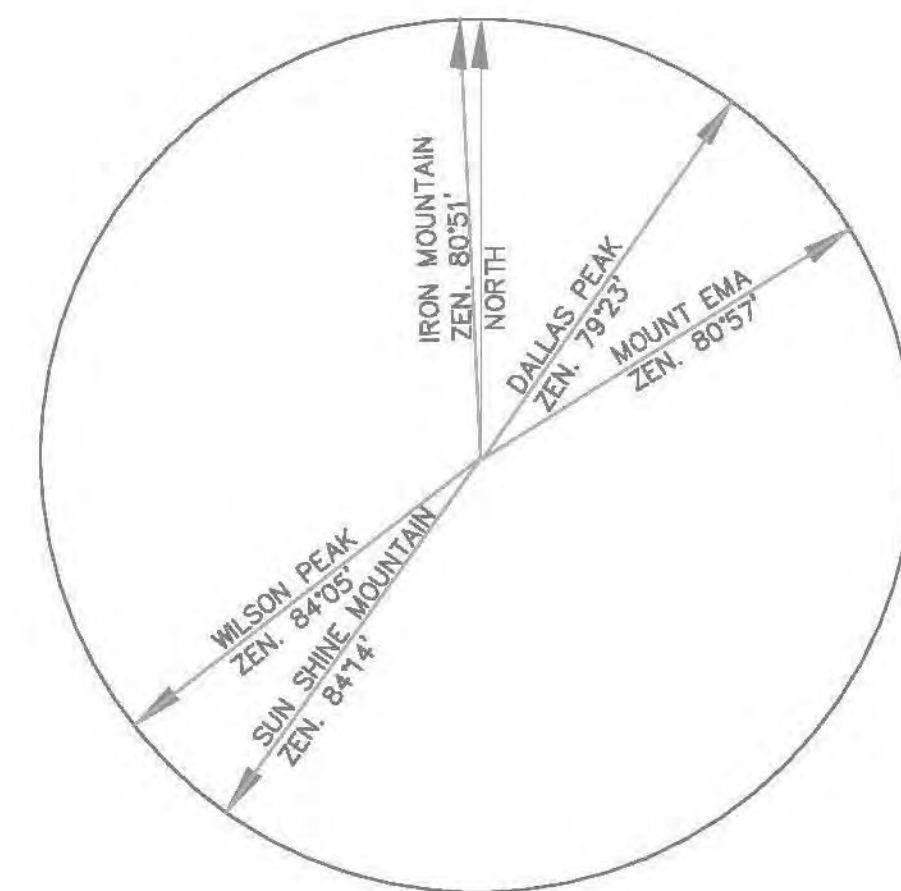

-  PAVEMENT
-  FOUND #5 REBAR WITH 1 1/2" ALUMINUM CAP LS 24954
-  SURVEY CONTROL POINT
-  TRANSFORMER
-  TELEPHONE PEDESTAL
-  SEWER MAN HOLE
-  FIRE HYDRANT



VIEW ANGLES

ANGLES ENUMERATED ARE ZENITH ANGLES

TREE CHART

-  SPRUCE TREE WITH TRUNK DIAMETER INDICATED IN INCHES
-  FIR TREE WITH TRUNK DIAMETER INDICATED IN INCHES
-  ASPEN TREE WITH TRUNK DIAMETER INDICATED IN INCHES





Tommy Hein
ARCHITECTS

Box 3327 108 S. OAK ST. PENTHOUSE
TELLURIDE, COLORADO 81435
WWW.TOMMYHEIN.COM 970.728.1220



© COPYRIGHT 2021 TOMMY HEIN ARCHITECT, LLC (THA). THESE ARCHITECTURAL DRAWINGS AND PLANS ARE THE WORK PRODUCT AND CAN NOT BE REPRODUCED OR UTILIZED WITHOUT THA'S EXPRESS WRITTEN PERMISSION.

Submissions

DRB REVIEW	20.08.06
PRICING SET	20.08.24
TAGS & SCHEDULES	20.09.08
DRB FINAL REVIEW	20.09.24
CHECK SET	21.04.15
DRB RE-REVIEW SET	21.04.26

Mountain
YACHT

ADDITION

LOT 424
121 TOUCHDOWN
DR., MOUNTAIN
VILLAGE

SITE PHOTOS

CONTRACTOR TO REVIEW AND COMPARE ALL CHAPTERS AND INTERDISCIPLINARY DRAWINGS AND REPORT ANY DISCREPANCIES TO THE ARCHITECT PRIOR TO ANY FIELD WORK BEING DONE IN ACCORDANCE WITH AIA DOCUMENT A201

A0.4

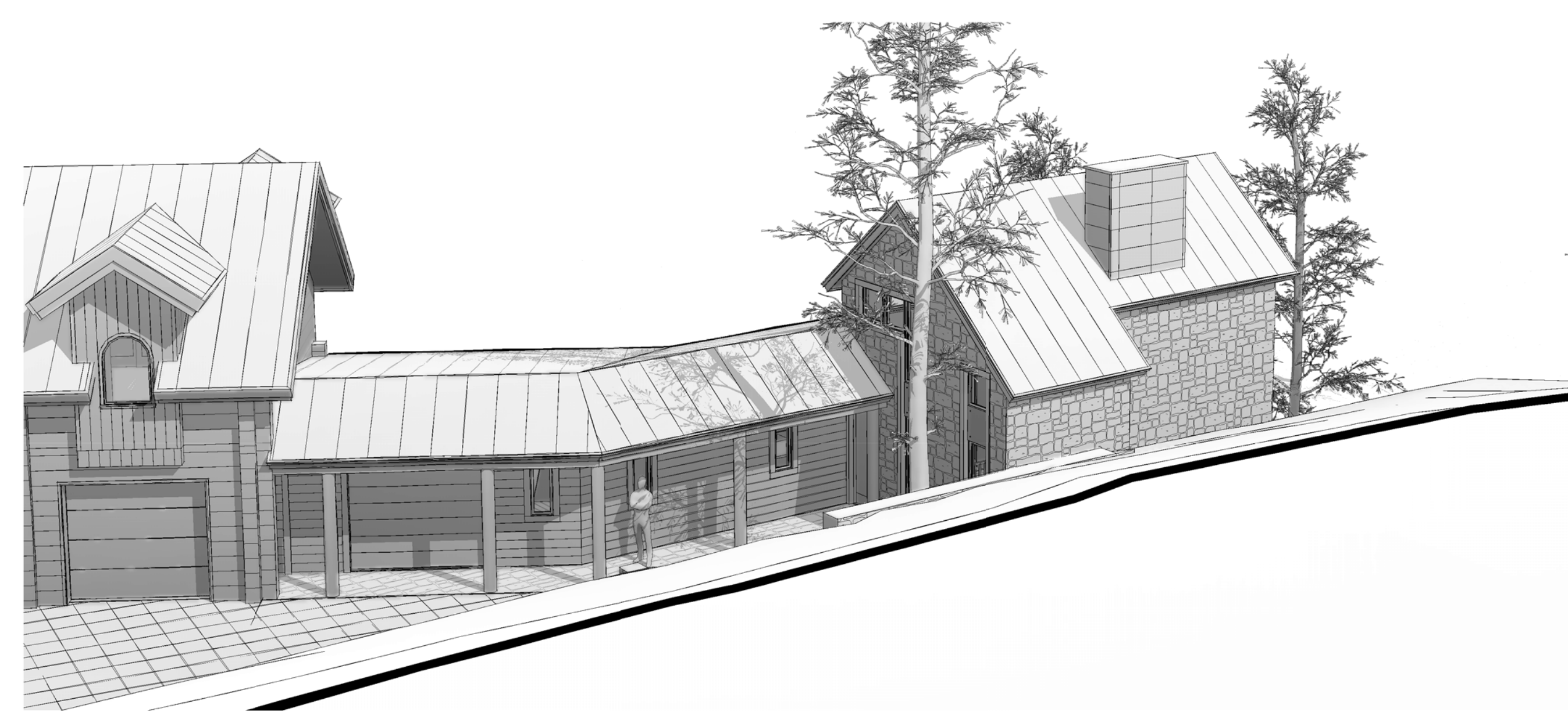
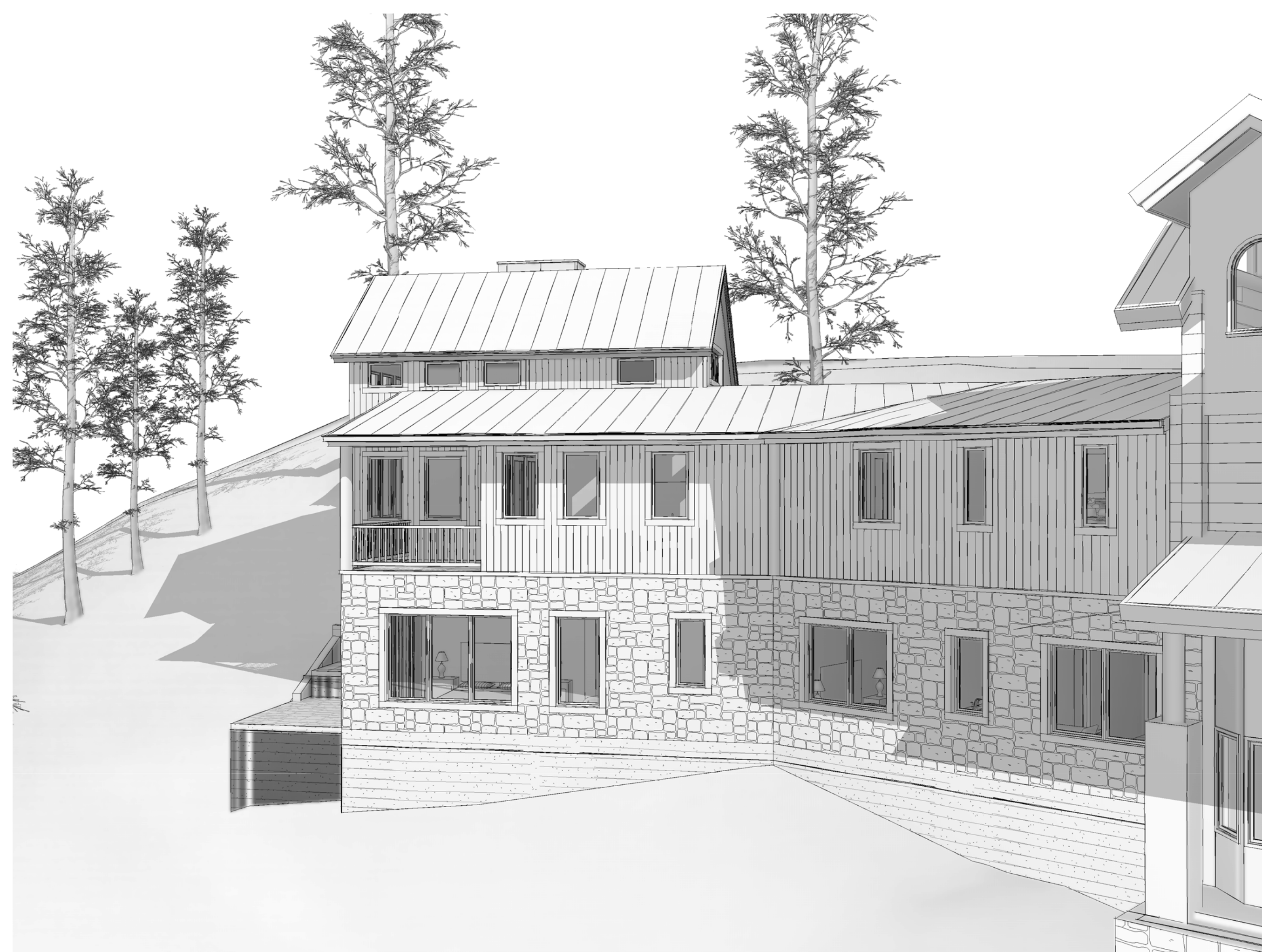

Tommy Hein
ARCHITECTS

Box 3327 108 S. OAK ST. PENTHOUSE
TELLURIDE, COLORADO 81435 970.728.1220
WWW.TOMMYHEIN.COM

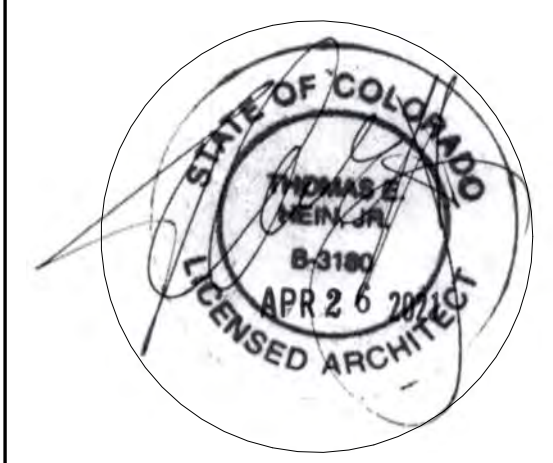

© COPYRIGHT 2021 TOMMY HEIN ARCHITECT, LLC (HA). THESE ARCHITECTURAL DRAWINGS AND PLANS ARE THE WORK PRODUCT AND CAN NOT BE REPRODUCED OR COPIED WITHOUT THE ARCHITECT'S EXPRESS WRITTEN PERMISSION.

Submissions

DRB REVIEW	20.08.06
PRICING SET	20.08.24
TAGS & SCHEDS	20.09.08
DRB FINAL REVIEW	20.09.24
CHECK SET	21.04.15
DRB RE-REVIEW SET	21.04.26

Mountain YACHT

ADDITION

LOT 424
121 TOUCHDOWN
DR., MOUNTAIN
VILLAGE

PERSPECTIVES

CONTRACTOR TO REVIEW AND COMPARE ALL CHAPTERS AND INTERDISCIPLINARY DRAWINGS AND REPORT ANY DISCREPANCIES TO THE ARCHITECT PRIOR TO ANY FIELD WORK BEING DONE IN ACCORDANCE WITH AIA DOCUMENT A201

A0.5

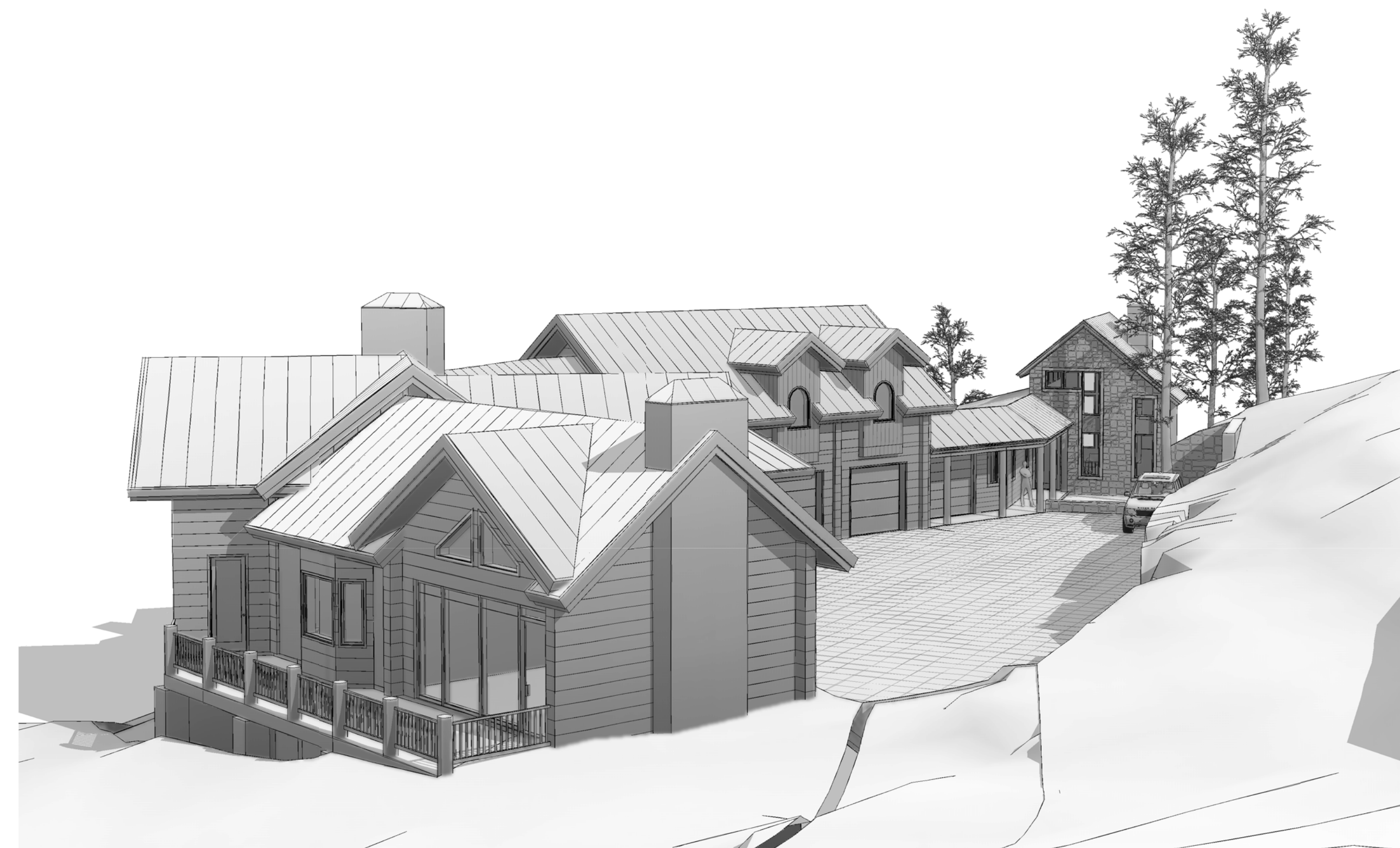
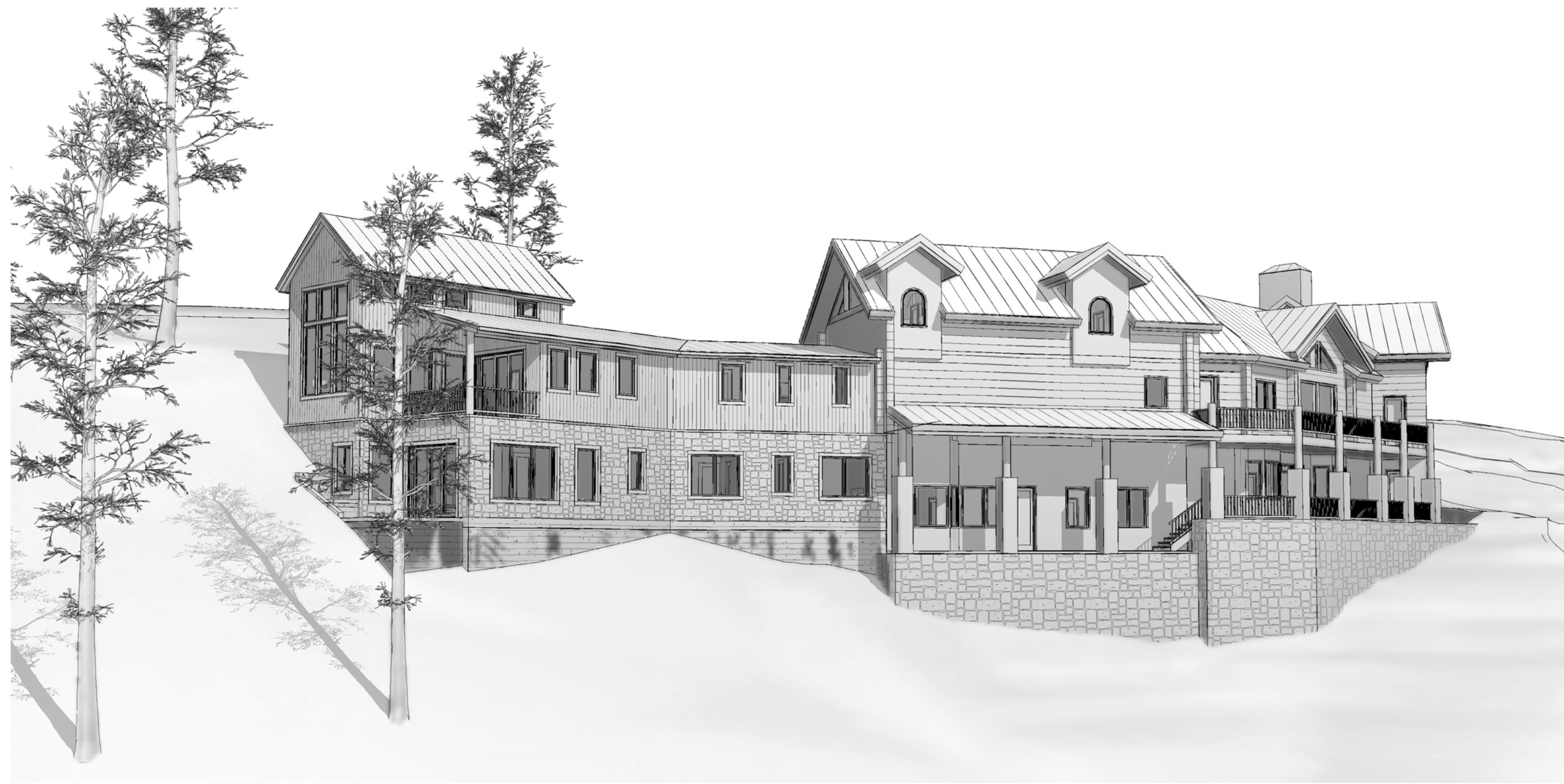

Tommy Hein
ARCHITECTS

Box 3327 108 S. OAK ST. PENTHOUSE
TELLURIDE, COLORADO 81435 970.728.1220
WWW.TOMMYHEIN.COM



© COPYRIGHT 2021 TOMMY HEIN ARCHITECT, LLC (THA). THESE ARCHITECTURAL DRAWINGS AND PLANS ARE THE WORK PRODUCT AND CAN NOT BE REPRODUCED OR COPIED WITHOUT THE ARCHITECT'S EXPRESS WRITTEN PERMISSION.

Submissions

DRB REVIEW	20.08.06
PRICING SET	20.08.24
TAGS & SCHEDS	20.09.08
DRB FINAL REVIEW	20.09.24
CHECK SET	21.04.15
DRB RE-REVIEW SET	21.04.26



ADDITION

LOT 424
121 TOUCHDOWN
DR., MOUNTAIN
VILLAGE

**OVERALL
PERSPECTIVES**

CONTRACTOR TO REVIEW AND COMPARE ALL CHAPTERS AND INTERDISCIPLINARY DRAWINGS AND REPORT ANY DISCREPANCIES TO THE ARCHITECT PRIOR TO ANY FIELD WORK BEING DONE IN ACCORDANCE WITH AIA DOCUMENT A201

A0.6

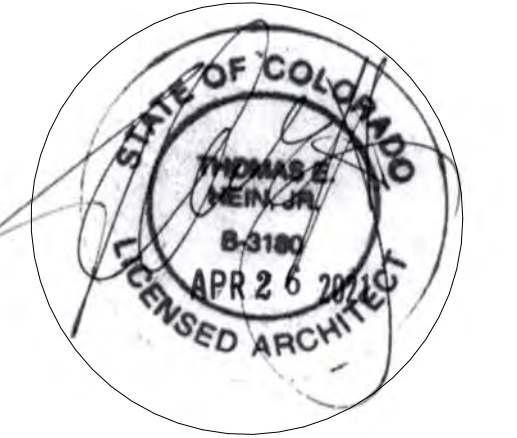

Submissions

DRB REVIEW	20.08.06
PRICING SET	20.08.24
TAGS & SCHEDS	20.09.08
DRB FINAL REVIEW	20.09.24
CHECK SET	21.04.15
DRB RE-REVIEW SET	21.04.26



ADDITION

LOT 424
121 TOUCHDOWN
DR., MOUNTAIN
VILLAGE

OVERALL SITE PLAN

CONTRACTOR TO REVIEW AND COMPARE ALL CHAPTERS AND INTERDISCIPLINARY DRAWINGS AND REPORT ANY DISCREPANCIES TO THE ARCHITECT PRIOR TO ANY FIELD WORK BEING DONE IN ACCORDANCE WITH AIA DOCUMENT A201

A1.0

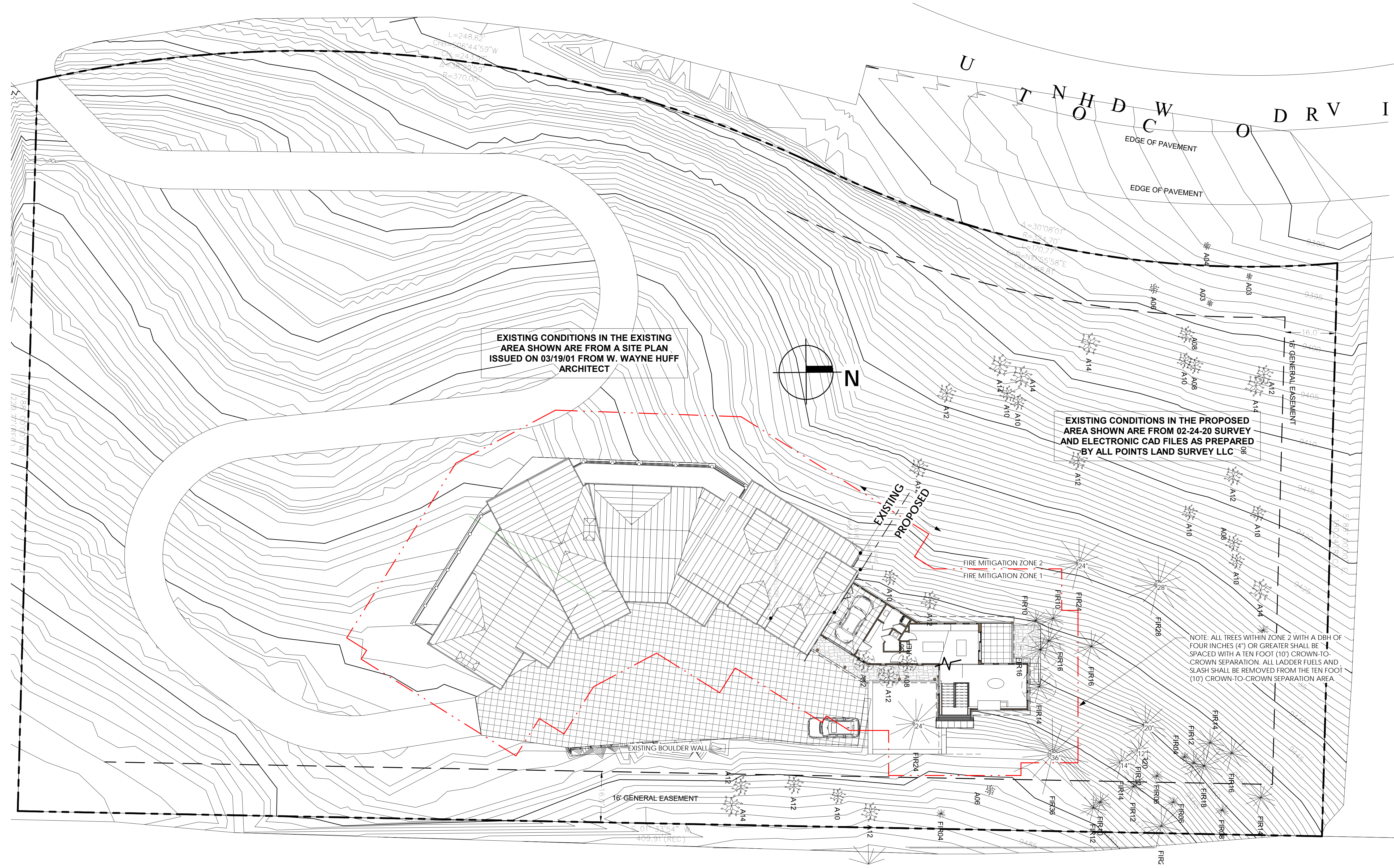

1 Overall Site Plan
SCALE 0 1 2 4 8 1/16" = 1'-0"

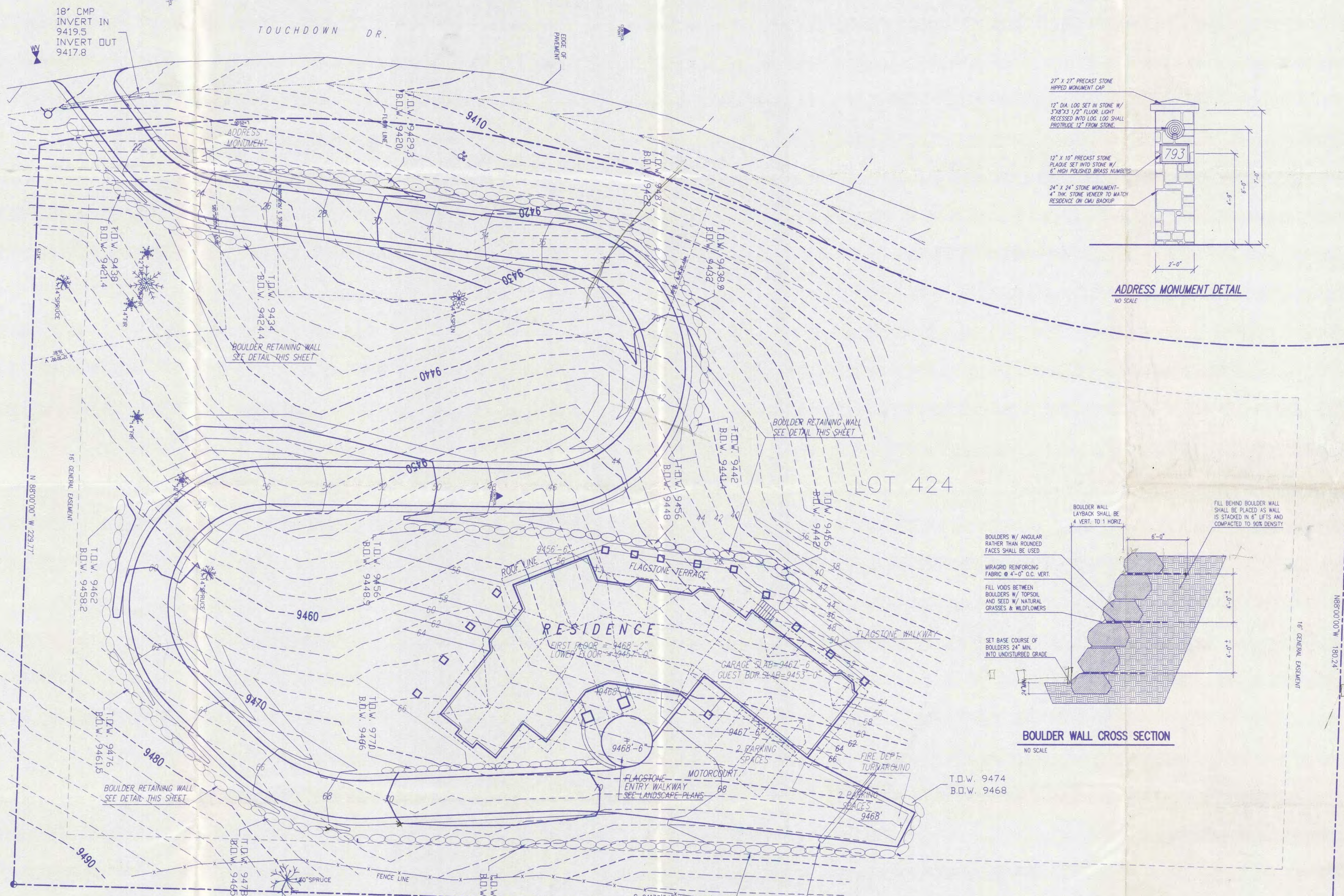

18" CMP
INVERT IN
9419.5
INVERT OUT
9417.8

TOUCHDOWN DR.

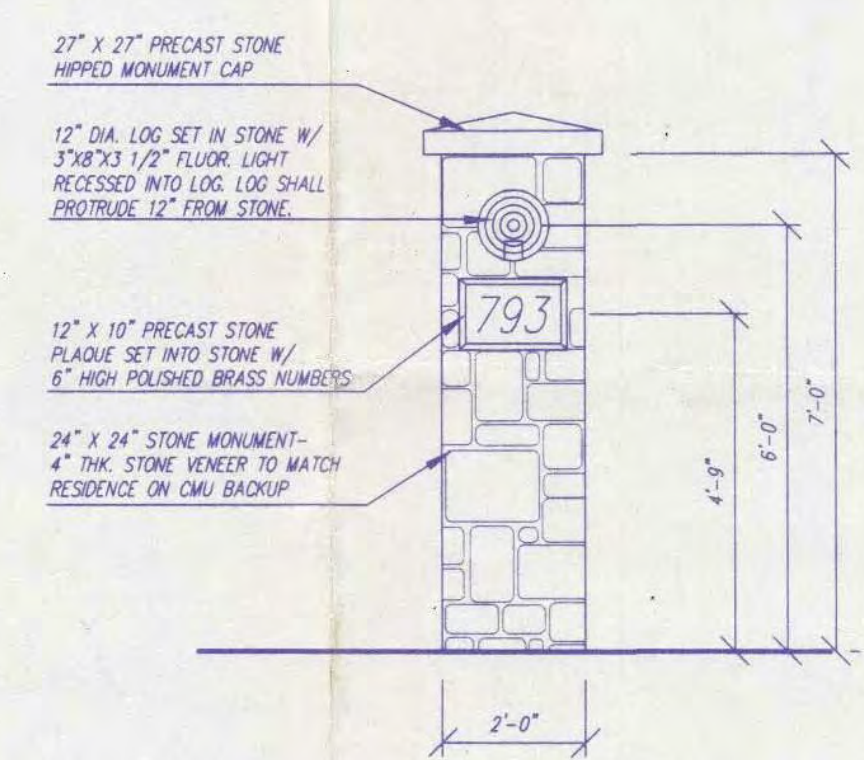

ADDRESS MONUMENT DETAIL
NO SCALE

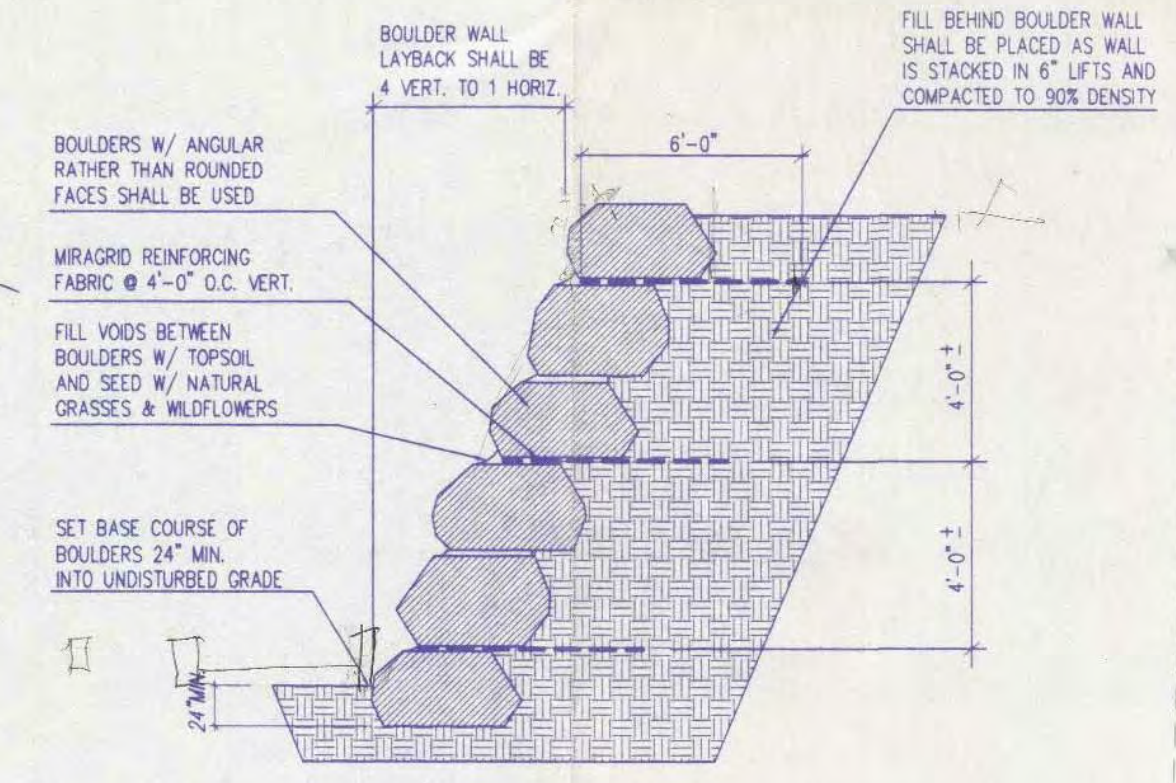

BOULDER WALL CROSS SECTION
NO SCALE

CABLE TV BOX
TELEPHONE BOX
ELECTRIC BOX

3-7-01
DETERMINED BY PETE DELUCA, GARMBENNET, WAYNE HUFF
TYPICAL SECTION FOR RETAIN WALL
STATIONS 1+85 - 2+40 LEFT

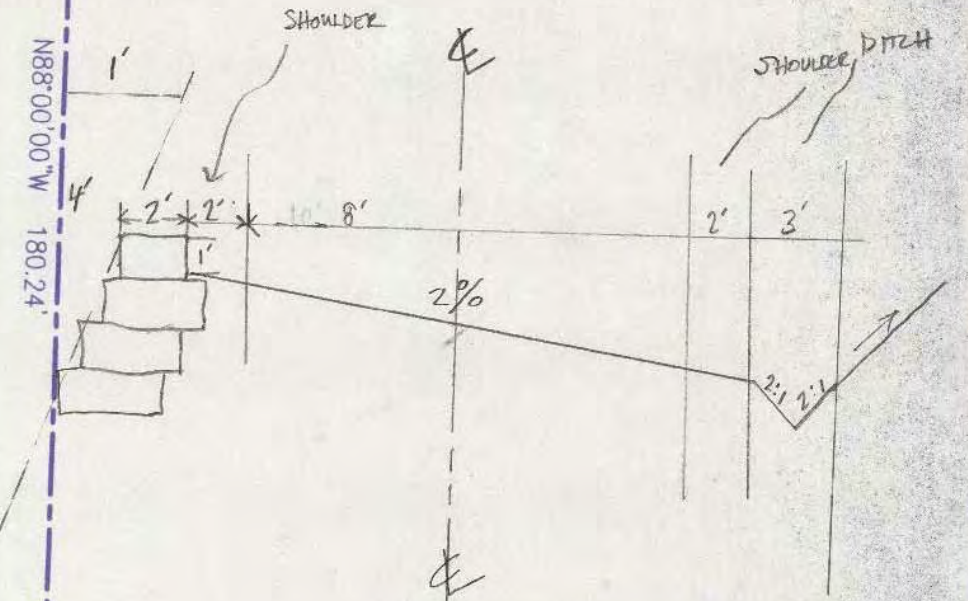

SITE PLAN
SCALE: 1/16" = 1'-0"

- Legend**
- FOUND No. 5 REBAR WITH 1.5" ALUMINUM CAP L.S. 24954
 - FOUND No. 5 REBAR WITH 1.5" ALUMINUM CAP L.S. 20632
 - ⊕ WATER VALVE
 - ⊕ FIRE HYDRANT
 - ⊕ CURB STOP
 - ⊕ SURVEY CONTROL POINT
 - EXISTING GRADE
 - FINISH GRADE

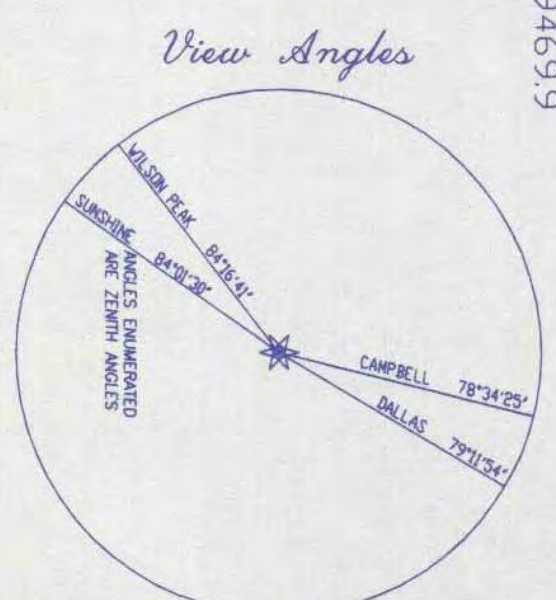

FIRE PROTECTION SYSTEM

1. FURNISH, DESIGN, AND INSTALL A COMPLETE FIRE PROTECTION SPRINKLER SYSTEM IN ACCORDANCE W/ ALL CODE REQUIREMENTS AND MANUFACTURERS RECOMMENDATIONS.
2. ALL SPRINKLER HEADS SHALL BE RECESSED INTO CEILINGS AND OR LOG BEAMS AND SHALL HAVE POP-OFF COVERS.

CONTRACTOR SHALL SUBMIT SPRINKLER HEAD LAYOUT DRAWING TO ARCHITECT FOR APPROVAL BEFORE START OF CONSTRUCTION.

18" CMP
INVERT IN 9464.5
INVERT OUT 9460.0

T.D.W. 9474
B.O.W. 9468

DATE ISSUED: 02 / 27 / 01	
REVISED:	
COLORADO	ARCHITECT
W. WAYNE HUFF	
793 MONUMENT AVE. PACOSA SPRINGS CO.	

99138

10-24-01
DETERMINED BY CONF. CALL WITH
WAYNE HUFF
TYP. SECTION FOR DRIVE
400 - 600

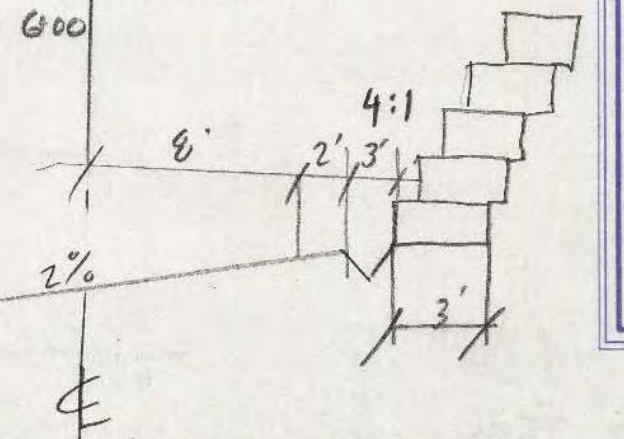

GENERAL CIVIL ENGINEERING NOTES:

1. THE EXISTING UTILITY LINES SHOWN ON THE PLANS ARE APPROXIMATE. AT LEAST TWO (2) FULL WORKING DAYS PRIOR TO COMMENCING CONSTRUCTION, THE CONTRACTOR SHALL CONTACT THE UTILITY NOTIFICATION CENTER OF COLORADO @ 1-800-922-1987 OR 811 TO GET ALL UTILITIES LOCATED. IF ANY OF THESE UNDERGROUND UTILITIES ARE IN CONFLICT WITH THE CONSTRUCTION PLANS, THE CONTRACTOR SHALL NOTIFY THE ENGINEER AND WORK WITH THE ENGINEER TO FIND A SOLUTION BEFORE THE START OF CONSTRUCTION.

INSTALLATION AND SEPARATION REQUIREMENTS SHALL BE COORDINATED WITH THE INDIVIDUAL UTILITY PROVIDERS.

THE UTILITY PROVIDERS ARE:

SEWER, WATER, CABLE TV AND FIBEROPTIC: TOWN OF MOUNTAIN VILLAGE
NATURAL GAS: BLACK HILLS ENERGY
POWER: SAN MIGUEL POWER
TELEPHONE: CENTURY LINK

2. PRIOR TO BEGINNING ANY CONSTRUCTION ACTIVITIES, ALL NECESSARY PERMITS SHALL BE OBTAINED BY THE OWNER OR CONTRACTOR.

3. IT IS THE CONTRACTOR'S RESPONSIBILITY TO INSURE THAT EXCAVATED SLOPES ARE SAFE AND COMPLY WITH OSHA REQUIREMENTS. REFER TO THE SITE-SPECIFIC REPORT FOR THIS PROJECT FOR ADDITIONAL INFORMATION.

4. ALL TRENCHES SHALL BE ADEQUATELY SUPPORTED OR LAID BACK PER OSHA REGULATIONS.

5. ALL MATERIALS AND CONSTRUCTION SHALL BE IN CONFORMANCE WITH THE TOWN OF MOUNTAIN VILLAGE DESIGN STANDARDS LATEST EDITION. ALL CONSTRUCTION WITHIN EXISTING STREET OR ALLEY RIGHT-OF-WAY SHALL BE SUBJECT TO TOWN OF MOUNTAIN VILLAGE INSPECTION.

6. THE CONTRACTOR SHALL HAVE ONE COPY OF THE STAMPED PLANS ON THE JOB SITE AT ALL TIMES.

7. THE CONTRACTOR SHALL NOTIFY THE TOWN 48 HOURS PRIOR TO THE START OF CONSTRUCTION.

8. THE CONTRACTOR IS RESPONSIBLE FOR IMPLEMENTING AND MAINTAINING EROSION AND SEDIMENT CONTROL MEASURES AT ALL TIMES DURING CONSTRUCTION. THE ADJOINING ROADWAYS SHALL BE FREE OF DEBRIS AT THE END OF CONSTRUCTION ACTIVITIES EACH DAY.

9. THE CONTRACTOR SHALL PROVIDE, ERECT AND MAINTAIN PROPER TRAFFIC CONTROL DEVICES UNTIL THE SITE IS OPEN TO TRAFFIC. ANY TRAFFIC CLOSURES MUST BE COORDINATED WITH THE TOWN OF MOUNTAIN VILLAGE.

10. ALL DAMAGE TO PUBLIC STREETS AND ROADS, INCLUDING HAUL ROUTES, TRAILS, OR STREET IMPROVEMENTS, OR TO PRIVATE PROPERTY, SHALL BE REPAIRED AT THE SOLE EXPENSE OF THE CONTRACTOR TO THE ORIGINAL CONDITIONS.

11. WHEN AN EXISTING ASPHALT STREET IS CUT, THE STREET MUST BE RESTORED TO A CONDITION EQUAL TO OR BETTER THAN ITS ORIGINAL CONDITION. THE FINISHED PATCH SHALL BLEND SMOOTHLY INTO THE EXISTING SURFACE. ALL LARGE PATCHES SHALL BE PAVED WITH AN ASPHALT LAY-DOWN MACHINE.

12. IF DEWATERING IS REQUIRED, THE CONTRACTOR SHALL NOTIFY THE ENGINEER. ANY DISCHARGE REQUIREMENTS SHALL BE COORDINATED WITH THE TOWN OF MOUNTAIN VILLAGE.

13. CONTRACTOR SHALL NOTIFY ALL RESIDENTS IN WRITING 24 HOURS PRIOR TO ANY SHUT-OFF IN SERVICE. THE NOTICES MUST HAVE CONTRACTOR'S PHONE NUMBER AND NAME OF CONTACT PERSON, AND EMERGENCY PHONE NUMBER FOR AFTER HOURS CALLS. ALL SHUT-OFFS MUST BE APPROVED BY THE TOWN AND TOWN VALVES AND APPURTENANCES SHALL BE OPERATED BY TOWN PERSONNEL.

14. CONTRACTOR SHALL KEEP SITE CLEAN AND LITTER FREE (INCLUDING CIGARETTE BUTTS) BY PROVIDING A CONSTRUCTION DEBRIS TRASH CONTAINER AND A BEAR-PROOF POLY-CART TRASH CONTAINER, WHICH IS TO BE LOCKED AT ALL TIMES.

15. CONTRACTOR MUST BE AWARE OF ALL TREES TO REMAIN PER THE DESIGN AND APPROVAL PROCESS AND PROTECT THEM ACCORDINGLY.

16. THE CONTRACTOR SHALL PROVIDE UNDERGROUND UTILITY AS-BUILTS TO THE TOWN.

17. ALL STRUCTURAL FILL UNDER HARDSCAPE OR ROADS MUST BE COMPACTED TO 95% MODIFIED PROCTOR (MIN.) AT PLUS OR MINUS 2% OF THE OPTIMUM MOISTURE CONTENT. NON-STRUCTURAL FILL SHALL BE PLACED AT 90% (MIN.) MODIFIED PROCTOR.

18. UNSUITABLE MATERIAL SHALL BE REMOVED AS REQUIRED BY THE SOILS ENGINEER. ALL MATERIALS SUCH AS LUMBER, LOGS, BRUSH, TOPSOIL OR ORGANIC MATERIALS OR RUBBISH SHALL BE REMOVED FROM ALL AREAS TO RECEIVE COMPACTED FILL.

19. NO MATERIAL SHALL BE COMPACTED WHEN FROZEN.

20. NATIVE TOPSOIL SHALL BE STOCKPILED TO THE EXTENT FEASIBLE ON THE SITE FOR USE ON AREAS TO BE REVEGETATED.

21. THE CONTRACTOR SHALL BE RESPONSIBLE FOR DUST ABATEMENT AND EROSION CONTROL MEASURES DEEMED NECESSARY BY THE TOWN, IF CONDITIONS WARRANT THEM.

22. ALL DISTURBED GROUND SHALL BE RE-SEEDED WITH A TOWN-APPROVED SEED MIX. REFER TO THE LANDSCAPE PLAN.

23. THE CONTRACTOR IS REQUIRED TO PROTECT ALL EXISTING SURVEY MONUMENTS AND PROPERTY CORNERS DURING GRADING AND CONSTRUCTION.

24. ALL UNDERGROUND PIPE SHALL BE PROTECTED WITH BEDDING TO PROTECT THE PIPE FROM BEING DAMAGED.

25. HOT TUBS SHALL DRAIN TO THE SANITARY SEWER (OR PUMPED TO AA CLEAN-OUT).

26. THE UTILITY PLAN DEPICTS FINAL UTILITY LOCATIONS BUT HAS BEEN COMPLETED AT A PRELIMINARY STAGE. CONTRACTOR SHALL VERIFY ALIGNMENTS WITH THE ARCHITECT PRIOR TO CONSTRUCTION.

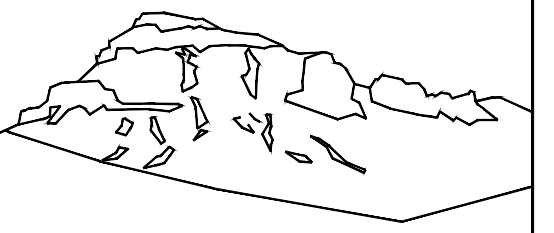

Uncompahgre
Engineering, LLC

P.O. Box 3945
Telluride, CO 81435
970-729-0683

SUBMISSIONS:

DRB SUBMITTAL 2020-08-06

DRB FINAL REVIEW 2020-09-24

Revised Footprints 2021-04-27

Lot 424
Touchdown Drive
Mtn. Village, CO



CONTRACTOR TO REVIEW AND COMPARE ALL CHAPTERS AND INTERDISCIPLINARY DRAWINGS AND REPORT ANY DISCREPANCIES TO THE ARCHITECT PRIOR TO ANY FIELD WORK BEING DONE IN ACCORDANCE WITH AIA DOCUMENT A201

Notes

C1

Scale: 1" = 10'

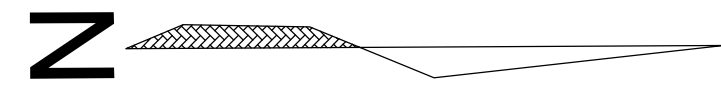

$\Delta=30^{\circ}08'01''$
 $R=324.70'$
 $L=170.77'$
 $ChB=N10^{\circ}55'58''E$
 $ChL=168.81'$

9390

9395

9400

9405

9410

9415

9420

9425

9430

9435

9440

9445

9450

9455

9460

9465

S 88°00'00" E, 180.24' (REC)

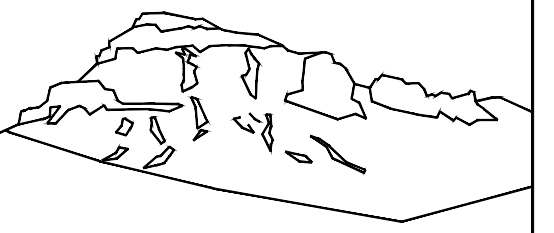

Uncompahgre
Engineering, LLC

P.O. Box 3945
Telluride, CO 81435
970-729-0683

SUBMISSIONS:

DRB SUBMITTAL	2020-08-06
DRB FINAL REVIEW	2020-09-24
Revised Footprints	2021-04-27

Lot 424
Touchdown Drive
Mtn. Village, CO



CONTRACTOR TO REVIEW AND COMPARE ALL
CHAPTERS AND INTERDISCIPLINARY DRAWINGS
AND REPORT ANY DISCREPANCIES TO THE
ARCHITECT PRIOR TO ANY FIELD WORK BEING
DONE IN ACCORDANCE WITH AIA DOCUMENT A201

Grading
and
Drainage
Plan

C2

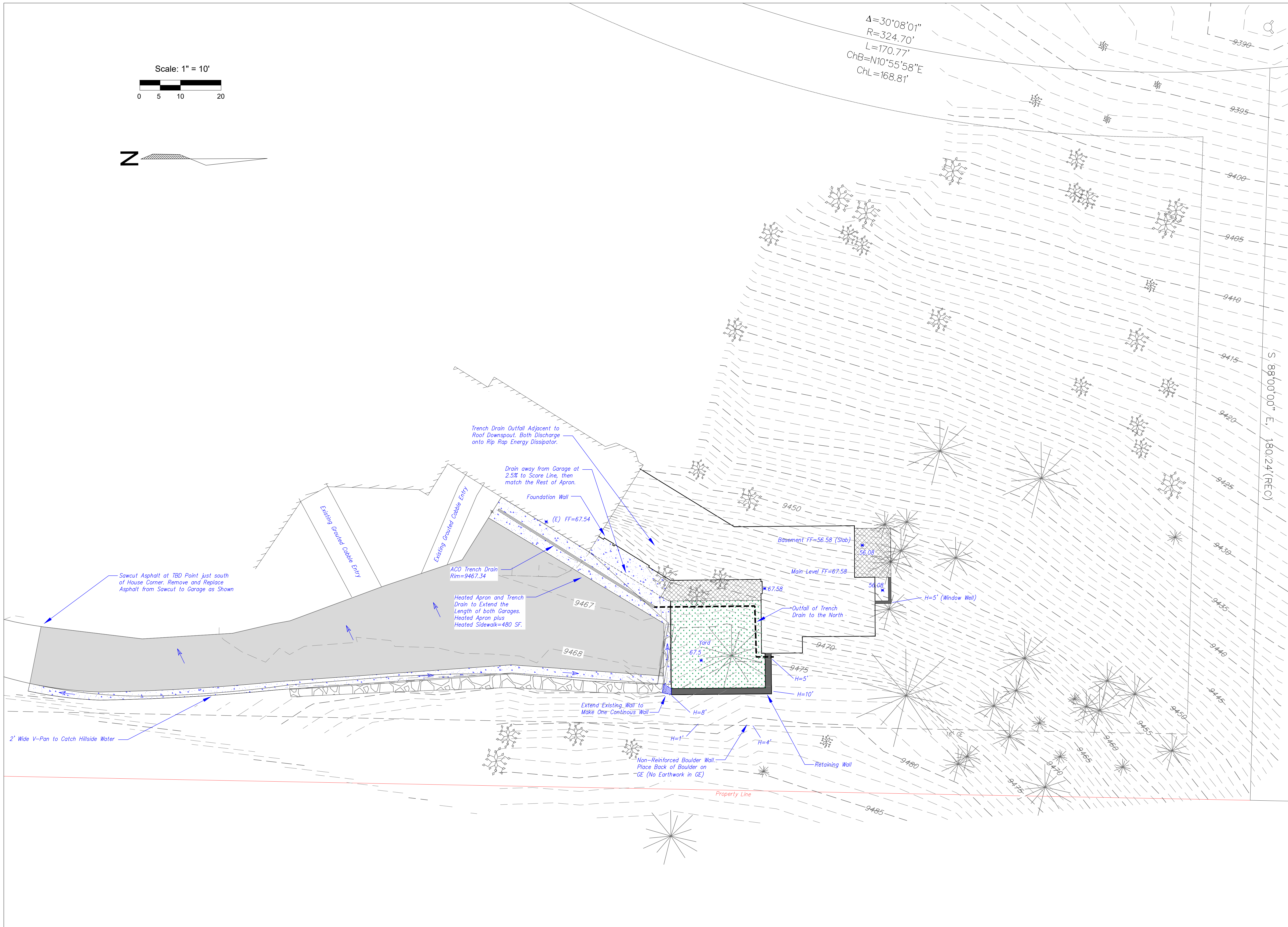

LANDSCAPE GENERAL NOTES:

1. ALL TREES AND SHRUBS SHALL BE FIELD LOCATED BY PROJECT ARCHITECT OR LANDSCAPE DESIGNER.
2. ALL TREES AND SHRUBS SHALL BE BACK FILLED WITH A TOPSOIL / ORGANIC FERTILIZER MIXTURE AT A 2:1 RATIO.
3. PLANTED TREES SHALL BE STAKED WITH FOUR FOOT METAL POST. TREES SHALL BE GUYED WITH 12 GAUGE GALVANIZED WIRE AND POLYPROPYLENE TREE RACE STRAPS.
4. PERENNIAL PLANTING BEDS SHALL BE TILLED TO A SIX INCH (6") DEPTH AND AMENDED WITH TOPSOIL AND ORGANIC FERTILIZER AT A 2:1 RATIO.
5. SEE PLANTING DETAILS FOR ALL DECIDUOUS AND EVERGREEN TREES.
6. MULCH ALL PERENNIAL BEDS WITH A PINE BARK SOIL CONDITIONER BY SOUTHWEST IMPORTERS, SHREDDED CEDAR BARK.
7. ALL PLANT MATERIAL TO MEET THE AMERICAN STANDARD FOR NURSERY STOCK.
8. ALL PLANTED MATERIALS SHALL BE NON-NOXIOUS SPECIES AS SPECIFIED WITHIN THE SAN MIGUEL COUNTY NOXIOUS WEED LIST. LANDSCAPING SHOWN ON THE LANDSCAPE PLAN SHALL COMPLY WITH SECTION 17.7.9 C.6.g OF THE COMMUNITY DEVELOPMENT CODE REGARDING NOXIOUS WEEDS.
9. NO TREES TO BE REMOVED OUTSIDE OF THE BUILDING ENVELOPE EXCEPT AS REQUIRED FOR FIRE MITIGATION AND/OR AS DESIGNATED BY THE TOWN FORESTER.
10. SEED WITH NATIVE GRASS SEED MIX, IF APPLICABLE, IS REQUIRED IN ALL DISTURBED AREAS ON THE PERIMETER OF THE BUILDING SITE AND AT UTILITY AND ROAD CUTS.
11. NATIVE GRASS SEED MIX SHALL BE COMPOSED OF THE FOLLOWING:

WESTERN YARROW	5%	TALL FESCUE	10%
ARIZONA FESCUE	10%	HARD FESCUE	5%
CREeping RED FESCUE	10%	ALPINE BLUEGRASS	15%
CANADA BLUEGRASS	10%	PERENNIAL RYEGRASS	15%
SLENDER WHEATGRASS	10%	MOUNTAIN BROME	15%

IRRIGATION SYSTEM NOTES:

1. A BACKFLOW PREVENTER BY A COLORADO LICENSED PLUMBER SHALL BE INSTALLED AFTER RECEIVING A PLUMBING PERMIT FROM THE TOWN.
2. INTERIOR AND EXTERIOR DRAIN VALVES AND AN INTERIOR DRAIN SHALL BE PROVIDED.
3. HEAD-TO-HEAD OR DOUBLE COVERAGE SHALL BE PROVIDED.
4. A MASTER CONTROL VALVE SHALL BE PROVIDED.
5. A FLOW CONTROL DEVICE TO PREVENT WATER LOSS IN THE EVENT OF A BREAK IN THE IRRIGATION SYSTEM SHALL BE PROVIDED.
6. SELF-SEALING HEADS SHALL BE PROVIDED TO REDUCE RUN OUT AFTER ZONE SHUT DOWN.
7. LOW-ANGLE SPRAY HEADS TO REDUCE WIND EFFECT AND MISTING ON AREAS OF TURF AND LOW-GROWING VEGETATION SHALL BE PROVIDED.
8. IRRIGATION SYSTEM SHALL HAVE A RAIN SENSOR.

EROSION CONTROL NOTES:

1. TO THE EXTENT PRACTICAL, ROAD AND DRIVEWAY SHALL BE REVEGETATED WITHIN THIRTY (30) DAYS OF THE DISTURBANCE TO AVOID UNSIGHTLY SCARS AND WEED INFESTATION ON THE LANDSCAPE.
2. UTILITY CUTS SHALL BE REVEGETATED IMMEDIATELY (WITHIN TWO WEEKS) AFTER INSTALLATION OF UTILITIES TO PREVENT WEED INFESTATION. LANDOWNER SHALL INSURE PROPER WEED CONTROL IN IMPACTED AREAS.
3. EROSION CONTROL ATTENTION TO DISTURBED AREAS SHALL BE IMPLEMENTED TO ENSURE THERE IS NO DETRIMENTAL IMPACT OF RUNOFF TO ANY PONDS, STREAMS OR WETLANDS.
4. IN AREAS THAT ARE TO REVEGETATED (ESPECIALLY SEEDING LOCATIONS WHICH HAVE RECEIVED HEAVY CONSTRUCTION EQUIPMENT TRAFFIC), SOIL SHALL BE SCARIFIED BEFORE THE APPLICATION OF SEED. SLOPED SURFACES SHALL BE ROUGHENED BY RUNNING TRACKED EQUIPMENT UP AND DOWN THE FACE OF THE SLOPE. (RUNNING SUCH EQUIPMENT ACROSS THE FACE OF THE SLOPE ENCOURAGES EROSION AND IS NOT RECOMMENDED).
5. NEWLY SEEDED AREAS SHALL BE PROTECTED FROM WIND A WATER EROSION THROUGH THE USE OF MULCHES. ACCEPTABLE MULCHES ARE WOOD CHIPS, STRAW, HYDRO-MULCH AND EROSION CONTROL NETTING.
6. EROSION CONTROL NETTING WILL BE REQUIRED ON SLOPES 3:1 OR STEEPER, IF ALLOWED BY VARIANCE TO SECTION 9-103-2 AND IN DRAINAGE SWALES. FOR ADDITIONAL INFORMATION, REFER TO THE CIVIL DRAWINGS.

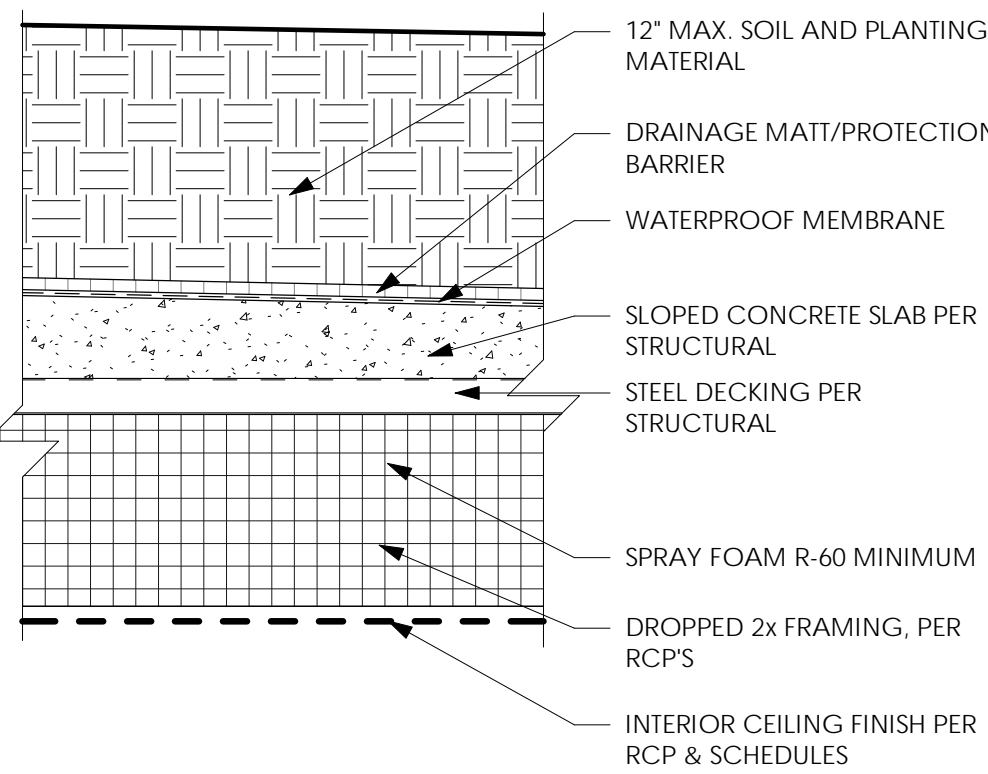

2 Earth Roof
SCALE 1 1/2" = 1'-0"

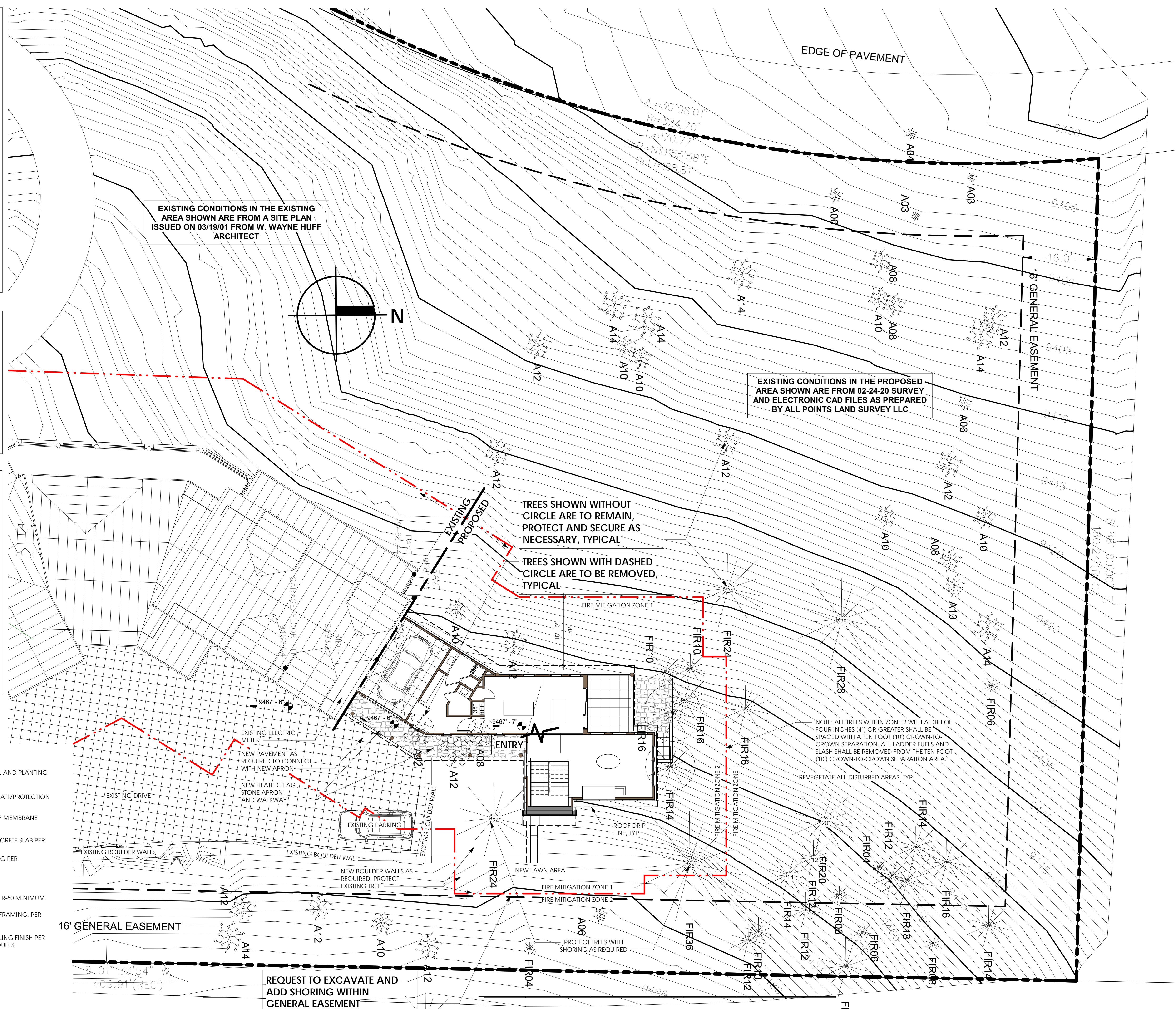

1 Site and Landscape Plan
SCALE 1" = 10'-0"

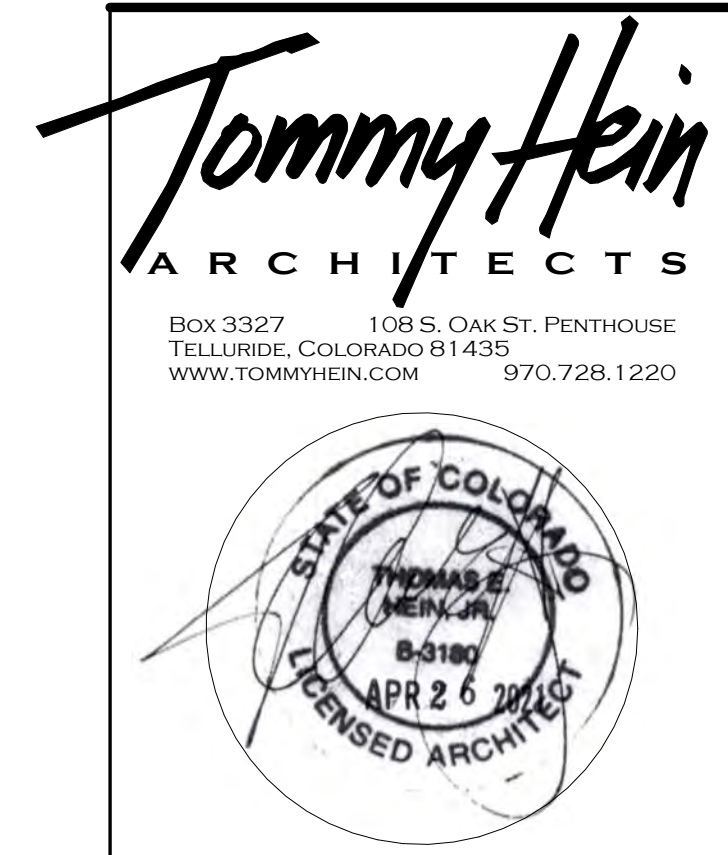

© COPYRIGHT 2021 TOMMY HEIN ARCHITECT, LLC (SHA) THESE ARCHITECTURAL DRAWINGS AND PLANS ARE THE WORK PRODUCT AND CAN NOT BE REPRODUCED OR DUPLICATED WITHOUT THE EXPRESS WRITTEN PERMISSION.

Submissions

DRB REVIEW	20.08.06
PRICING SET	20.08.24
TAGS & SCHEDS	20.09.08
DRB FINAL REVIEW	20.09.24
CHECK SET	21.04.15
DRB RE-REVIEW SET	21.04.26



ADDITION
LOT 424
121 TOUCHDOWN DR., MOUNTAIN VILLAGE

SITE AND LANDSCAPE PLAN

CONTRACTOR TO REVIEW AND COMPARE ALL CHAPTERS AND INTERDISCIPLINARY DRAWINGS AND REPORT ANY DISCREPANCIES TO THE ARCHITECT PRIOR TO ANY FIELD WORK BEING DONE IN ACCORDANCE WITH AIA DOCUMENT A201

A1.2



© COPYRIGHT 2021 TOMMY HEIN ARCHITECT, LLC (THA). THESE ARCHITECTURAL DRAWINGS AND PLANS ARE THE WORK PRODUCT AND CAN NOT BE REPRODUCED OR DUPLICATED WITHOUT THA'S EXPRESS WRITTEN PERMISSION.

Submissions

DRB REVIEW	20.08.06
PRICING SET	20.08.24
TAGS & SCHEDS	20.09.08
DRB FINAL REVIEW	20.09.24
CHECK SET	21.04.15
DRB RE-REVIEW SET	21.04.26



ADDITION

LOT 424
121 TOUCHDOWN
DR., MOUNTAIN
VILLAGE

**CONSTRUCTION
MITIGATION
PLAN**

CONTRACTOR TO REVIEW AND COMPARE ALL CHAPTERS AND INTERDISCIPLINARY DRAWINGS AND REPORT ANY DISCREPANCIES TO THE ARCHITECT PRIOR TO ANY FIELD WORK BEING DONE IN ACCORDANCE WITH AIA DOCUMENT A201

A1.3

- STAGING NOTES:**
1. CONTOUR INTERVAL IS 1'-0"
 2. CUT AND SLASH TO BE REMOVED FROM SITE.
 3. PEDESTRIAN PROTECTION TO BE IMPLEMENTED WITH PROPER SIGNAGE AND HARD HAT REQUIREMENTS.
 4. RECYCLING CONTAINERS TO BE PROVIDED FOR ALL RECYCLABLE MATERIALS.
 5. LIMIT OF TREE REMOVAL TO BE WITHIN THE INDICATED AREA EXCEPT WHERE DESIGNATED AS "TREES TO REMAIN" WITHIN THE EXCAVATION LIMIT.
 6. SILT FENCE TO BE OF GEO-TECHNICAL ENGINEER APPROVED MATERIAL BURIED EIGHT INCHES (8") BELOW GRADE AND EXTENDING UP TWELVE INCHES (12") ABOVE GRADE. MATERIAL ATTACHED TO PICKETS LOCATED 4'-0" ON CENTER.
 7. ALL LIMITS OF EXCAVATION TO BE WITHIN PERIMETER OF SILT FENCE.
 8. TREES TO REMAIN, AS DESIGNATED BY PROJECT ARCHITECT, ARE TO BE PROTECTED THROUGHOUT THE ENTIRE CONSTRUCTION PROCESS.
 9. TREES TO BE REMOVED FOR FIRE MITIGATION WILL BE MARKED IN THE FIELD BY THE TOWN FORESTER AND THE ZONES SHOWN HEREIN DO NOT BIND THE TOWN IN THE APPLICATION OF THE FIRE MITIGATION REGULATIONS.

- SOIL PROTECTION NOTES:**
1. PRIOR TO EXCAVATION, TOPSOIL SHALL BE STRIPPED AND STORED ON THE SITE OR IN A LOCATION APPROVED BY THE REVIEW AUTHORITY.
 2. GOOD QUALITY TOPSOIL SHALL BE REPLACED IN AREAS REQUIRING LANDSCAPING OR REVEGETATION.
 3. TOPSOIL SHALL BE SPREAD TO A MINIMUM DEPTH OF FOUR INCHES (4").
 4. A SOIL AMENDMENT, SUCH AS FULLY COMPOSTED MANURE, SHALL BE ROTOTILLED INTO ALL AREAS THAT WILL BE SODDED OR SEEDED.
 5. AMENDMENTS SHALL BE TILLED INTO THE SOIL TO A SIX TO EIGHT (6"-8") DEPTH.
 6. THE RATE OF APPLICATION OF SOIL AMENDMENT SHALL BE THREE (3) CUBIC YARDS PER 1,000 SQUARE FEET.
 7. NEWLY SEEDED AREAS SHALL BE PROTECTED FROM WIND AND WATER EROSION THROUGH THE USE OF WEED FREE MULCHES. ACCEPTABLE MULCHES ARE: STRAW, HYDRO-MULCH AND, WHEN NEEDED, BIODEGRADABLE EROSION-CONTROL NETTING. NYLON NETTING IS PROHIBITED.
 - 8.

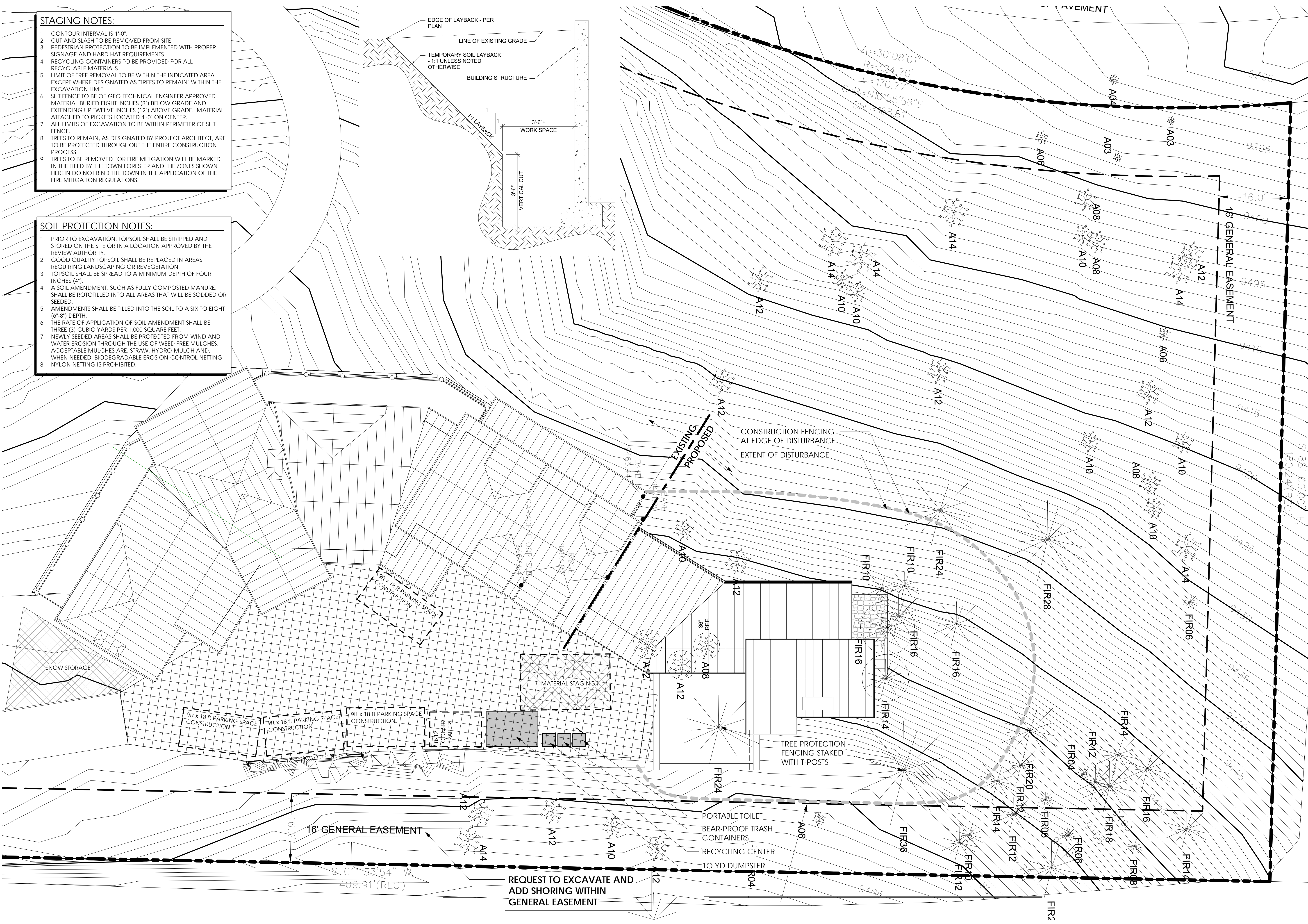
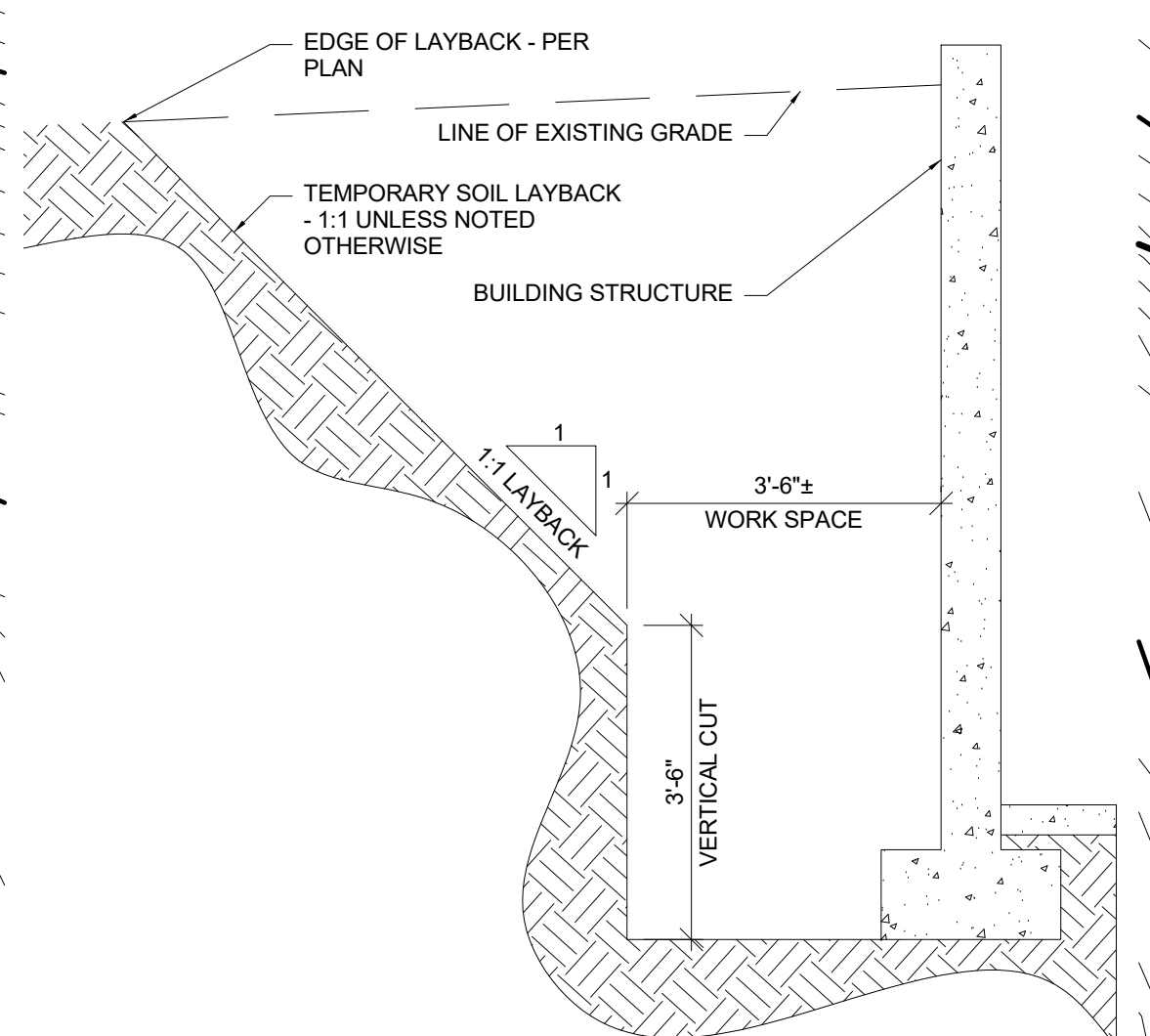

1 Construction Mitigation Plan
SCALE 0 1 2 3 4 1" = 10'-0"

CDC SITE COVERAGE DEFINITION:

THE TOTAL HORIZONTAL AREA OF ANY BUILDING, CARPORT, PORTE-COCHERE OR ARCADE AND SHALL ALSO INCLUDE WALKWAYS, ROOF OVERHANGS, EAVES, EXTERIOR STAIRS, DECKS, COVERED PORCHES, TERRACES AND PATIOS. SUCH HORIZONTAL MEASUREMENT SHALL BE FROM THE DRIP LINES OF BUILDINGS AND FROM THE EXTERIOR SURFACE OF THE TOTAL WALL ASSEMBLY

SITE COVERAGE

MAX COVERAGE ALLOWED = 30% MAX (SINGLE FAMILY WITH LOTS > 1 TO 5 ACRES)

LOT SIZE = 87,642.72 SF

SITE COVERAGE (INCLUDING EXISTING AND PROPOSED) = 8,037.6 SF (9.17%)

9.17% IS 20.83% BELOW THE ALLOWABLE 30%

MV CDC - FLOOR AREA DEFINITION

THE SUM OF ALL AREA(S) WITHIN THE EXTERIOR WALLS OF A BUILDING OR PORTION THEREOF, MEASURED FROM THE EXTERIOR FACES OF THE EXTERIOR WALLS, EXCLUDING THE AREA WITHIN ATTACHED OR DETACHED GARAGES AND ATTICS OR CRAWL SPACES PROVIDED THAT SUCH AREAS MEET THE FOLLING FLOOR AREA EXCLUSIONS. e. STAIRWAYS: STAIRS WITHIN A DWELLING UNIT SHALL ONLY BE COUNTED ON EVERY OTHER LEVEL.

GROSS FLOOR AREA SUMMARY

TOTAL EXISTING FLOOR AREA: = 7,847 SF
 TOTAL PROPOSED FLOOR AREA: = 2,777.3 SF
 TOTAL COMBINED FLOOR AREA: = 10,624.3 SF

TOTAL FLOOR AREA - GROSS

Name	Level	Area
Level 0	Level 0	1619.0 SF
LEVEL 1	Level 1	861.3 SF
GARAGE	Level 1	296.9 SF
Grand total: 3		2777.3 SF

FLOOR AREA SUMMARY

EXISTING STRUCTURE
 LEVEL 00: = 3,268 SF
 LEVEL 01: = 3,045 SF
 LEVEL 02: = 274 SF
 CARETAKER: = 530 SF
 GARAGE: = 730 SF
TOTAL EXISTING FLOOR AREA: = 7,847 SF

PROPOSED ADDITION
 LEVEL 00: = 1,619.0 SF
 LEVEL 01: = 861.3 SF
 GARAGE: = 296.9 SF
TOTAL PROPOSED FLOOR AREA: = 2,777.3 SF

TOTAL COMBINED FLOOR AREA: = 10,624.3 SF

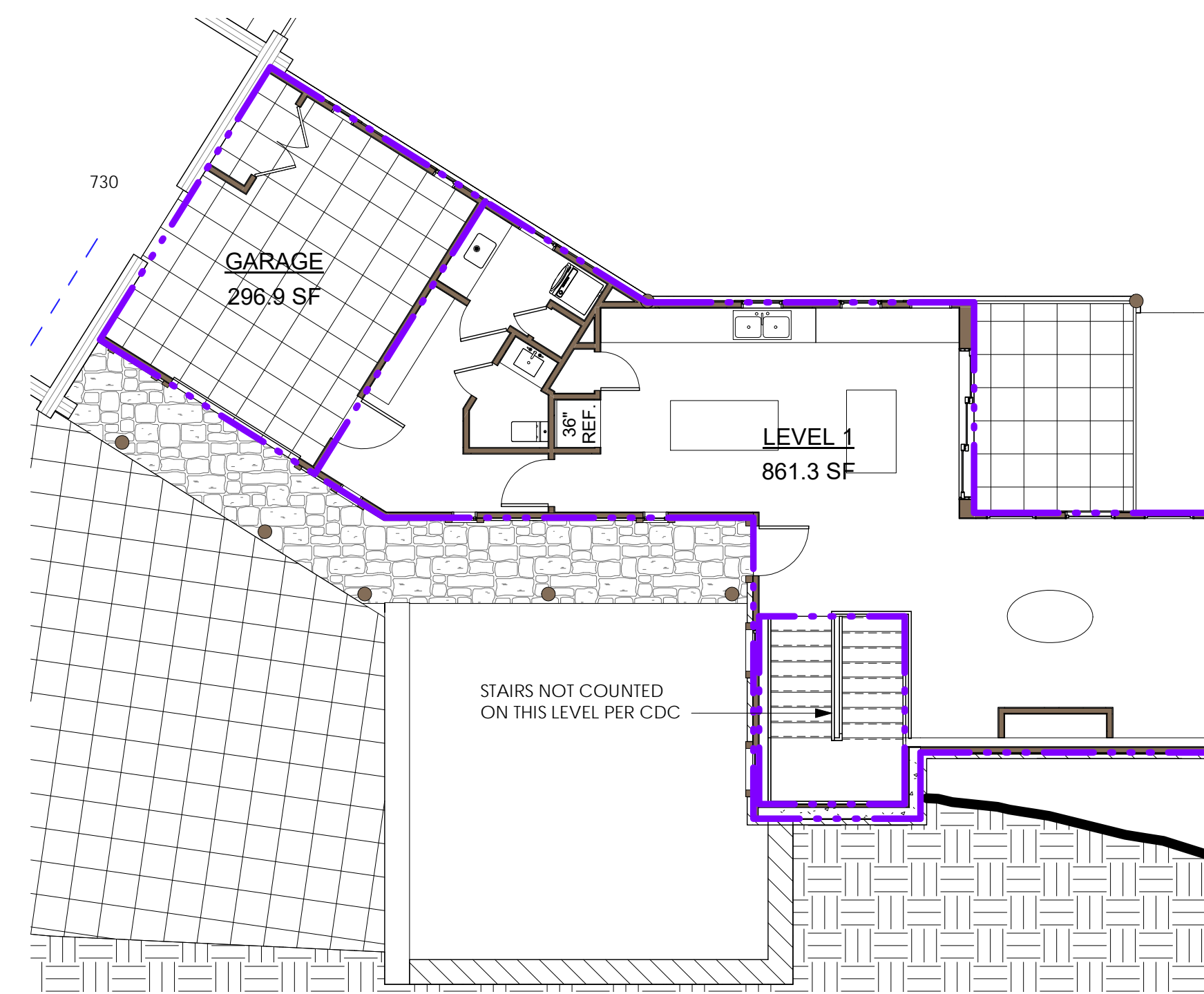

2 Level 1
 SCALE 0 1 2 4 8 1/8" = 1'-0"

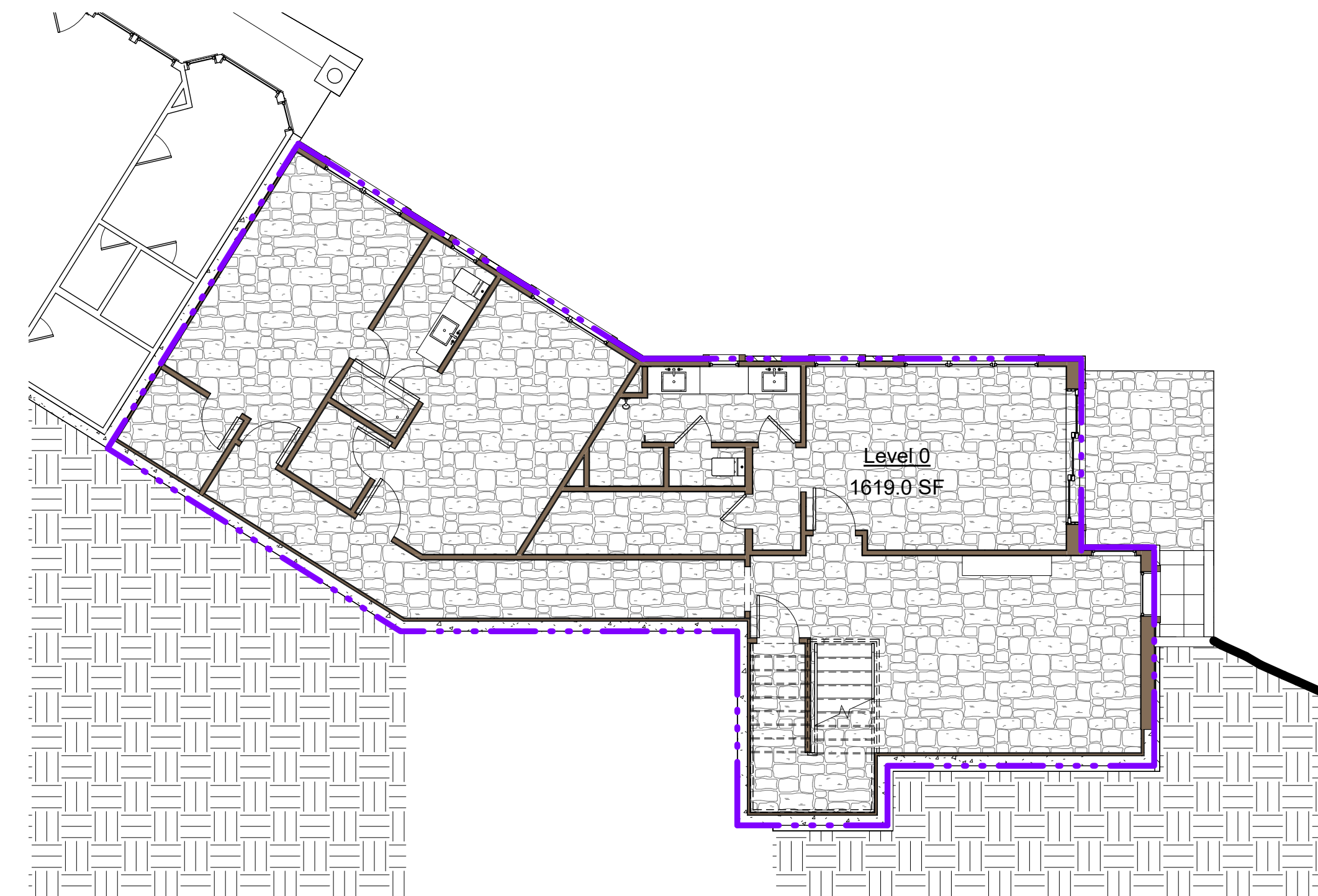

1 Level 0
 SCALE 0 1 2 4 8 1/8" = 1'-0"



3 Lot Coverage
 SCALE 0 1 2 4 5 1" = 10'-0"

Tommy Hein
 ARCHITECTS

Box 3327 108 S. OAK ST. PENTHOUSE
 TELLURIDE, COLORADO 81435
 WWW.TOMMYHEIN.COM 970.728.1220

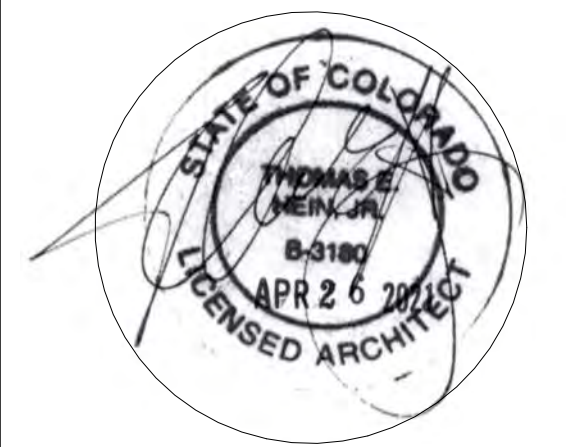

© COPYRIGHT 2021 TOMMY HEIN ARCHITECT, LLC (THA). THESE ARCHITECTURAL DRAWINGS AND PLANS ARE THE WORK PRODUCT AND CAN NOT BE REPRODUCED OR DUPLICATED WITHOUT THA'S EXPRESS WRITTEN PERMISSION.

Submissions

DRB REVIEW	20.08.06
PRICING SET	20.08.24
TAGS & SCHEDS	20.09.08
DRB FINAL REVIEW	20.09.24
CHECK SET	21.04.15
DRB RE-REVIEW SET	21.04.26

Mountain YACHT

ADDITION

LOT 424
 121 TOUCHDOWN DR., MOUNTAIN VILLAGE

FLOOR AREA AND SITE COVERAGE

CONTRACTOR TO REVIEW AND COMPARE ALL CHAPTERS AND INTERDISCIPLINARY DRAWINGS AND REPORT ANY DISCREPANCIES TO THE ARCHITECT PRIOR TO ANY FIELD WORK BEING DONE IN ACCORDANCE WITH AIA DOCUMENT A201

A1.4

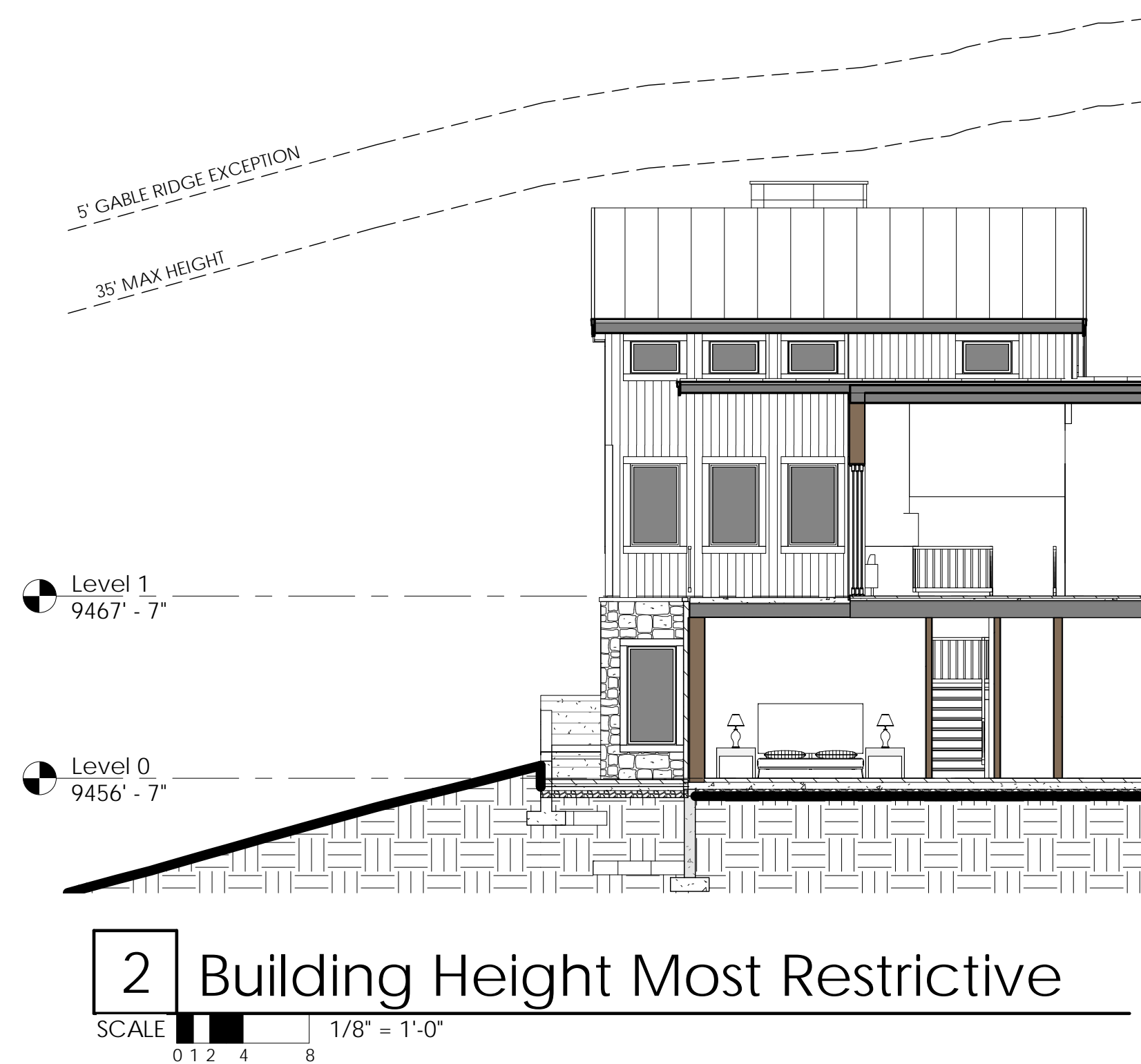

2 Building Height Most Restrictive

SCALE 0 1 2 4 8 1/8" = 1'-0"

BUILDING HEIGHT AVERAGE

NUMBER	ROOF HEIGHT	GRADE HEIGHT	HEIGHT
AH1	9478.79	9454.78	24.01
AH2	9478.79	9457.69	21.1
AH3	9478.79	9459.35	19.44
AH4	9478.79	9458.73	20.06
AH5	9478.79	9456.18	22.61
AH6	9478.79	9454.47	24.32
AH7	9487.30	9463.90	23.4
AH8	9487.30	9461.55	25.75
AH9	9487.30	9452.74	34.56

AVERAGE HEIGHT = 23.92
MAX AVERAGE ALLOWABLE = 30
COMPLIANT BY = 6.08

MAXIMUM BUILDING HEIGHT PER CDC
HIGHEST RIDGE = 9491.03
GRADE BELOW = 9461.08
MAX HEIGHT AT MOST RESTRICTIVE = 29.95
MAX HEIGHT ALLOWABLE = 40' (35'+5)
COMPLIANT BY = 10.05

MAX CHIMNEY HEIGHT PER CDC
HIGHEST POINT = 9492.63
GRADE BELOW = 9466.15
MAX HEIGHT AT MOST RESTRICTIVE = 26.48
MAX HEIGHT ALLOWABLE = 40' (35'+5)
COMPLIANT BY = 13.52

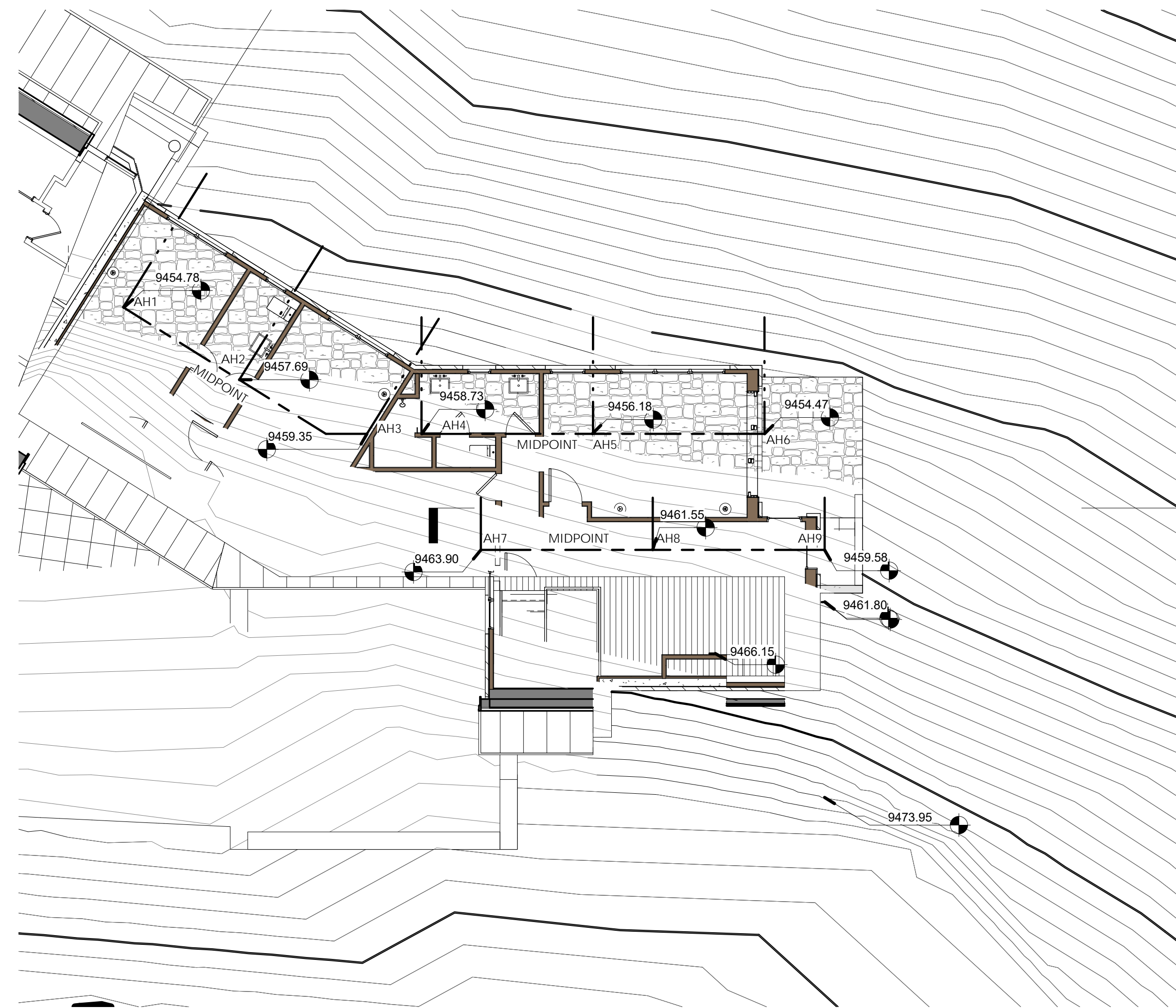

3 Max Average Height Site Plan

SCALE 0 1 2 4 8 1/8" = 1'-0"

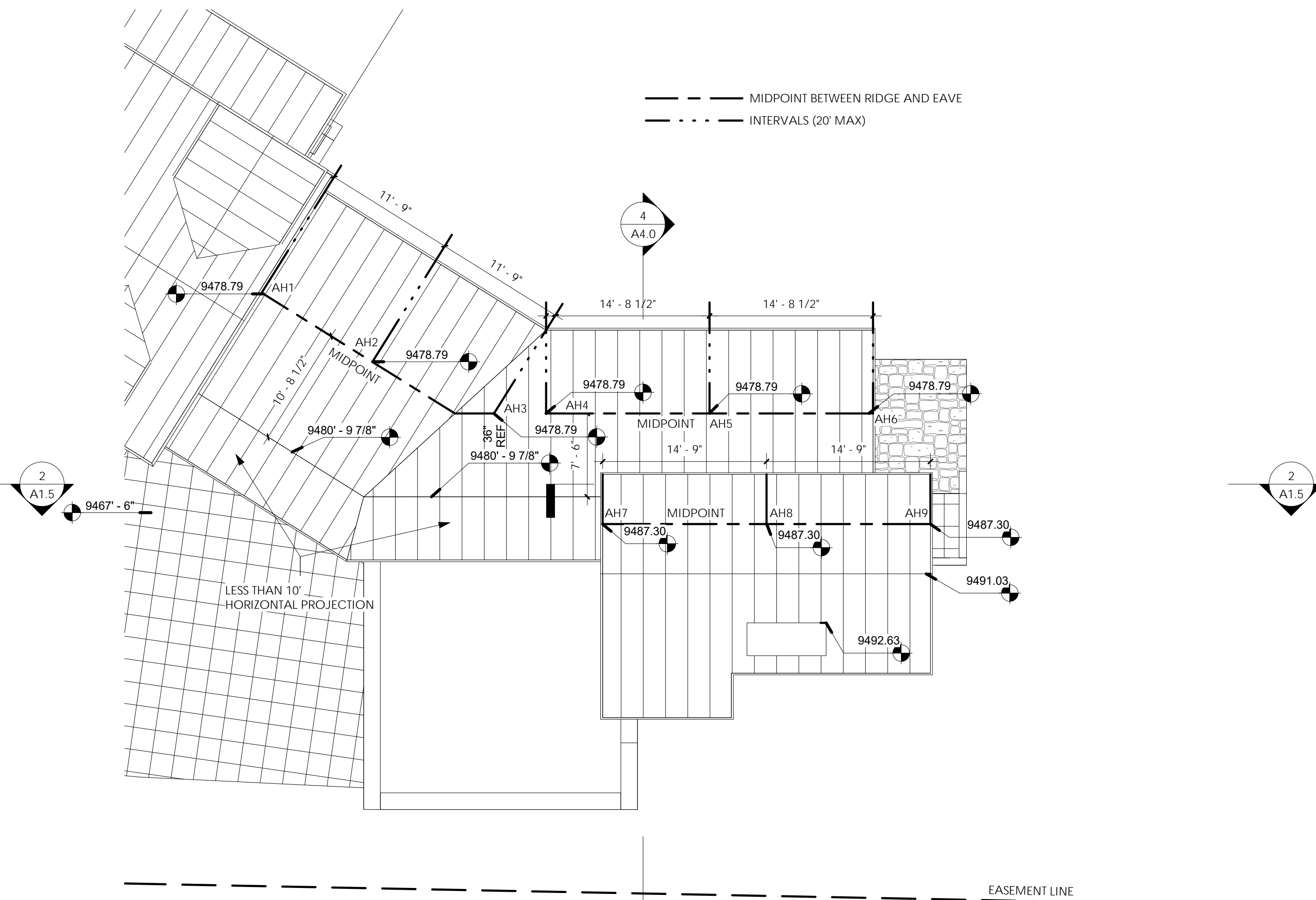

1 Max Average Height Roof Plan

SCALE 0 1 2 4 8 1/8" = 1'-0"

Submissions

DRB REVIEW	20.08.06
PRICING SET	20.08.24
TAGS & SCHEDS	20.09.08
DRB FINAL REVIEW	20.09.24
CHECK SET	21.04.15
DRB RE-REVIEW SET	21.04.26



ADDITION

LOT 424
121 TOUCHDOWN
DR., MOUNTAIN
VILLAGE

**BUILDING
HEIGHT
COMPLIANCE
ANALYSIS**

CONTRACTOR TO REVIEW AND COMPARE ALL CHAPTERS AND INTERDISCIPLINARY DRAWINGS AND REPORT ANY DISCREPANCIES TO THE ARCHITECT PRIOR TO ANY FIELD WORK BEING DONE IN ACCORDANCE WITH AIA DOCUMENT A201

A1.5



STONE 267.97
TIMBER 68.55
STEEL 29.80
GLASS 47.91
CONCRETE 0



4 Materials - South Elevation

SCALE 0 1/2 4 8 1/8" = 1'-0"

STONE 168.35
TIMBER 261.96
STEEL 69.65
GLASS 191.07
CONCRETE 35.25

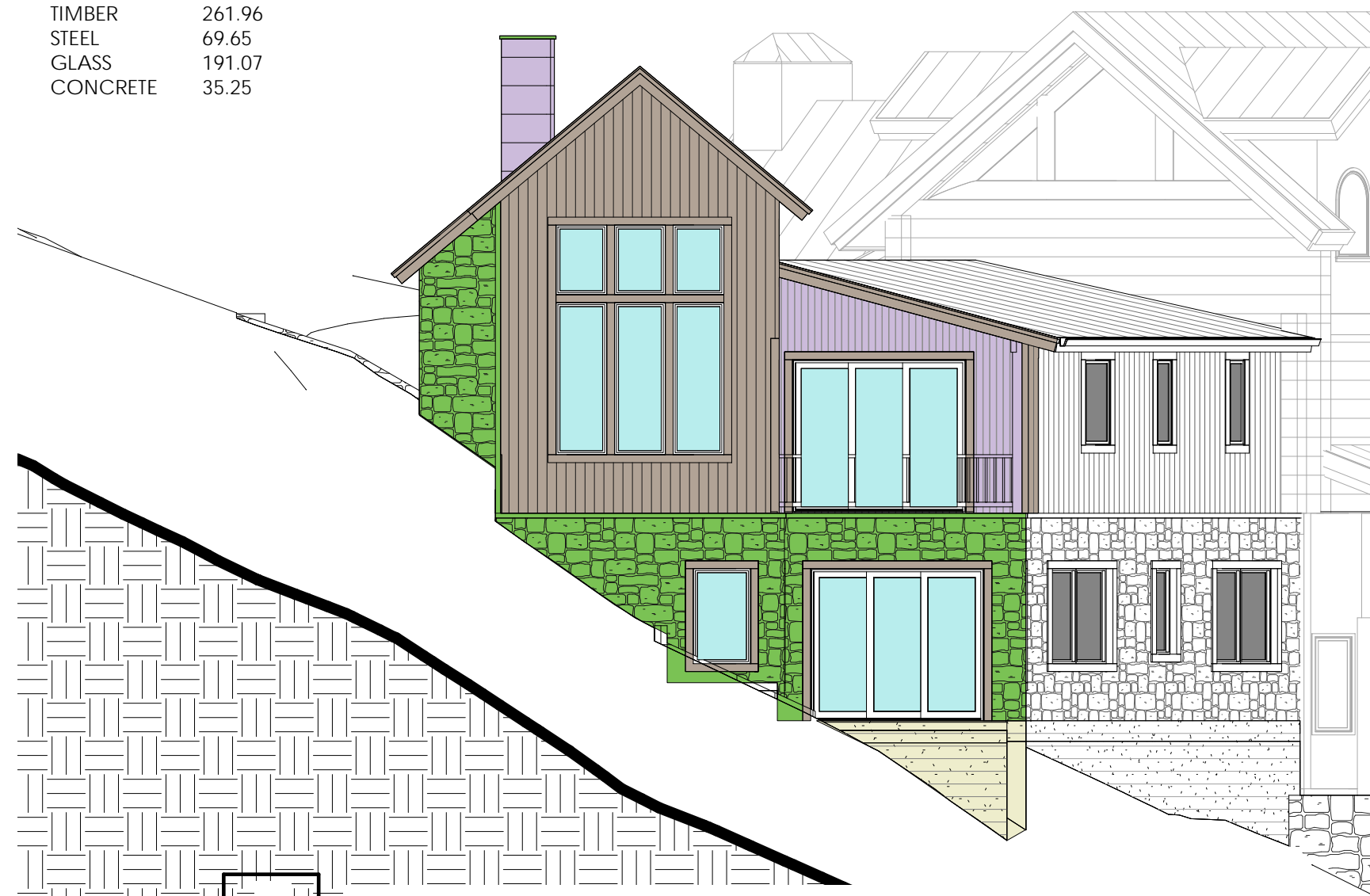

3 Materials - North Elevation

SCALE 0 1/2 4 8 1/8" = 1'-0"

STONE 326.77
TIMBER 14.88
STEEL 52.24
GLASS 0
CONCRETE 0

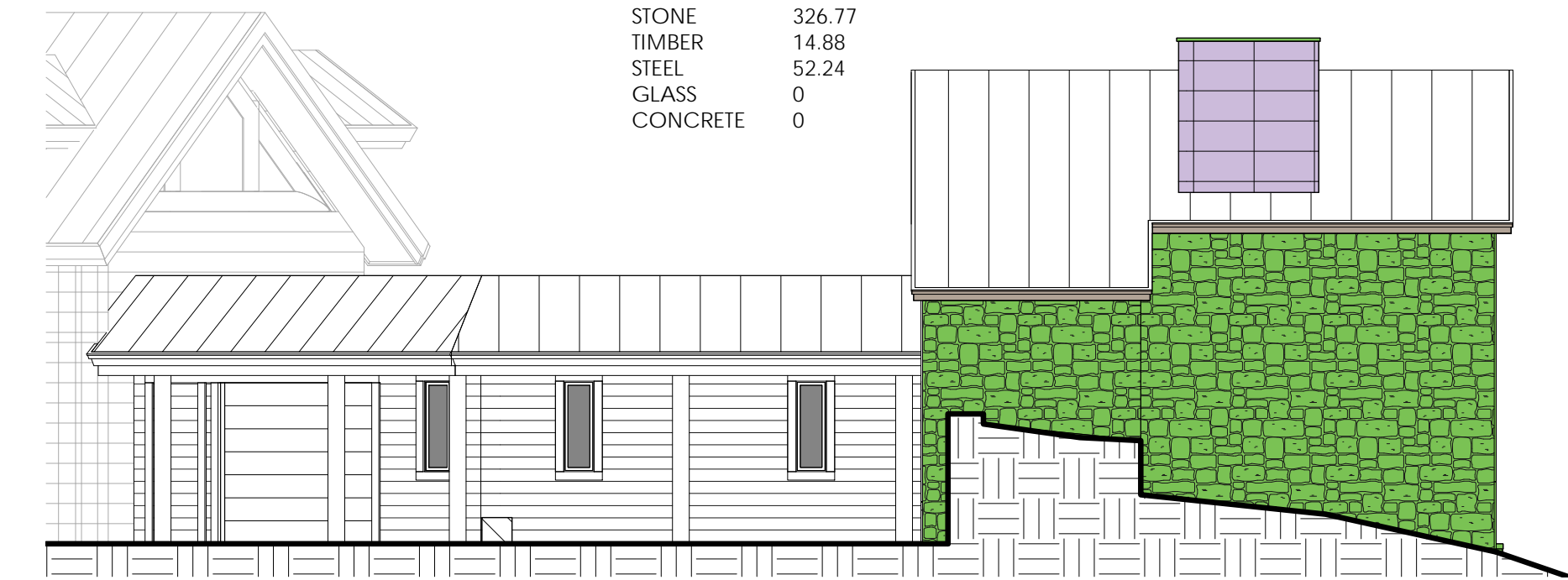

1 Materials - East Elevation

SCALE 0 1/2 4 8 1/8" = 1'-0"

STONE 0
TIMBER 277.09
STEEL 0
GLASS 12.49
CONCRETE 0

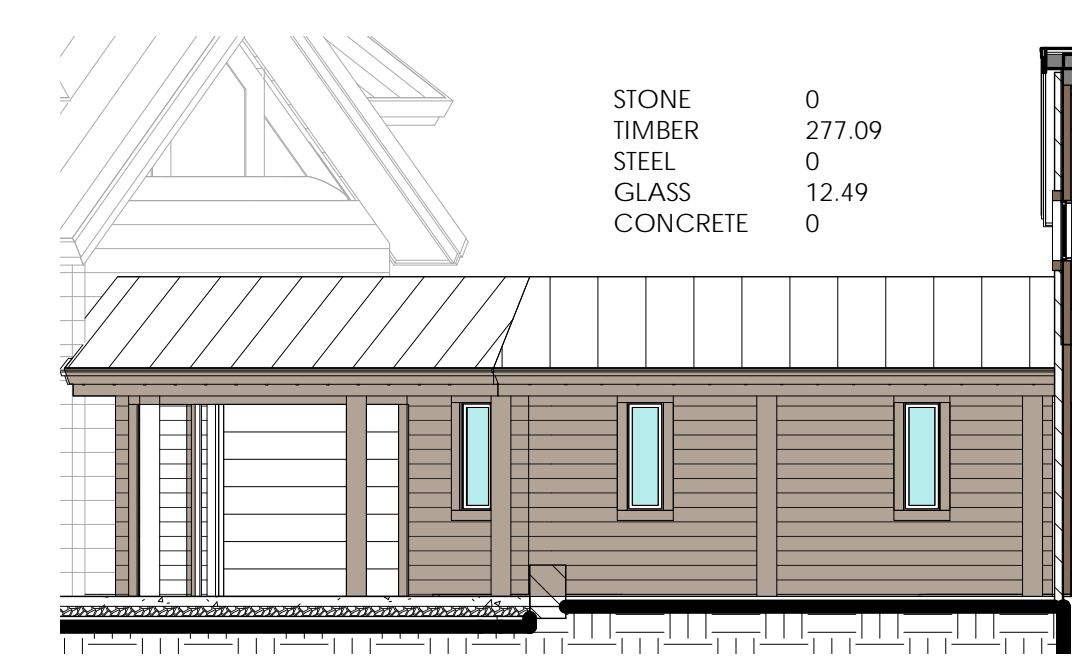

2 Materials - East Elevation Partial

SCALE 0 1/2 4 8 1/8" = 1'-0"

MATERIAL HATCHES:

- CONCRETE
- STEEL
- STONE
- TIMBER
- GLASS

STONE 413.70
TIMBER 293.29
STEEL 296.93
GLASS 215.78
CONCRETE 279.07



5 Materials - West Elevation

SCALE 0 1/2 4 8 1/8" = 1'-0"

TOTAL MATERIAL AREA = 3,322.8 SF
TOTAL GLASS AREA = 467.3 SF
TOTAL STONE AREA = 1176.8 SF

GLASS % (MAX ALLOWED 40%) = 14.1%
STONE % (35% REQUIRED) = 35.4%

MATERIALS	
Material	Area
CONCRETE	35.3 SF
CONCRETE	279.1 SF
GLASS	191.1 SF
GLASS	47.9 SF
GLASS	12.5 SF
GLASS	215.8 SF
STEEL	69.7 SF
STEEL	29.8 SF
STEEL	52.2 SF
STEEL	296.9 SF
STONE	168.4 SF
STONE	268.0 SF
STONE	326.8 SF
STONE	413.7 SF
TIMBER	262.0 SF
TIMBER	68.6 SF
TIMBER	14.9 SF
TIMBER	277.1 SF
TIMBER	293.3 SF
Grand total	3322.8 SF

TIMBER	
Material	Area
TIMBER	262.0 SF
TIMBER	68.6 SF
TIMBER	14.9 SF
TIMBER	277.1 SF
TIMBER	293.3 SF
TOTAL	915.8 SF

METAL	
Material	Area
STEEL	69.7 SF
STEEL	29.8 SF
STEEL	52.2 SF
STEEL	296.9 SF
TOTAL	448.6 SF

CONCRETE	
Material	Area
CONCRETE	35.3 SF
CONCRETE	279.1 SF
TOTAL	314.3 SF

STONE	
Material	Area
STONE	168.4 SF
STONE	268.0 SF
STONE	326.8 SF
STONE	413.7 SF
TOTAL	1176.8 SF

GLASS	
Material	Area
GLASS	191.1 SF
GLASS	47.9 SF
GLASS	12.5 SF
GLASS	215.8 SF
TOTAL	467.3 SF

EXTERIOR MATERIAL CALCULATIONS

CONTRACTOR TO REVIEW AND COMPARE ALL CHAPTERS AND INTERDISCIPLINARY DRAWINGS AND REPORT ANY DISCREPANCIES TO THE ARCHITECT PRIOR TO ANY FIELD WORK BEING DONE IN ACCORDANCE WITH AIA DOCUMENT A201

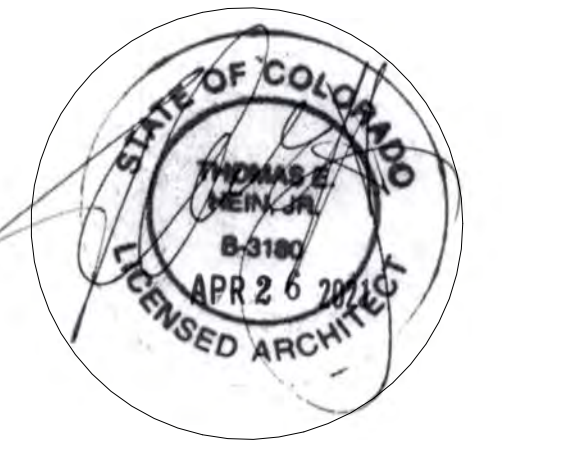

Submissions

DRB REVIEW	20.08.06
PRICING SET	20.08.24
TAGS & SCHEDULES	20.09.08
DRB FINAL REVIEW	20.09.24
CHECK SET	21.04.15
DRB RE-REVIEW SET	21.04.26

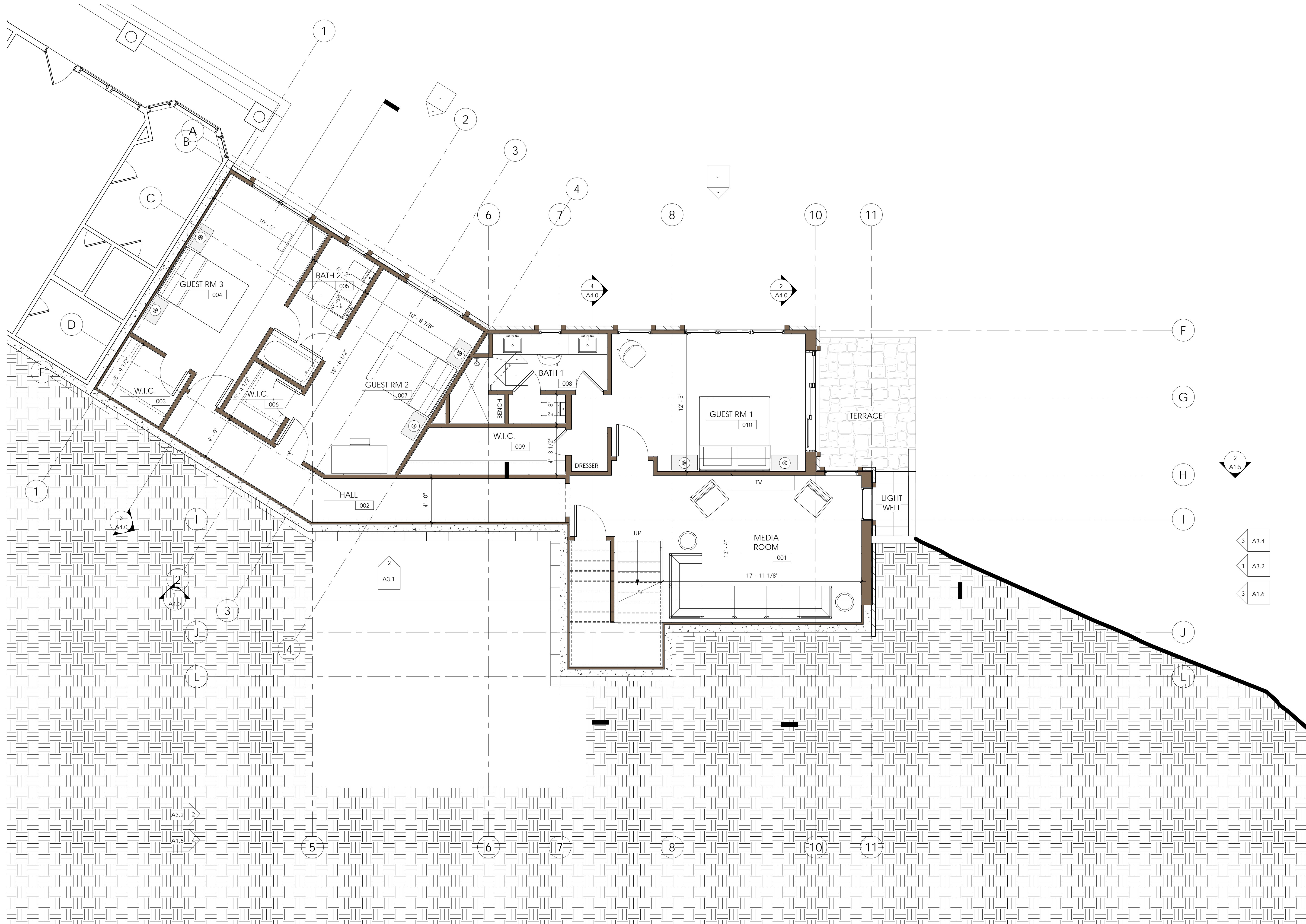

1 Level 0
SCALE 1/4" = 1'-0"



ADDITION

LOT 424
121 TOUCHDOWN
DR., MOUNTAIN
VILLAGE

LOWER LEVEL

CONTRACTOR TO REVIEW AND COMPARE ALL CHAPTERS AND INTERDISCIPLINARY DRAWINGS AND REPORT ANY DISCREPANCIES TO THE ARCHITECT PRIOR TO ANY FIELD WORK BEING DONE IN ACCORDANCE WITH AIA DOCUMENT A201

A2.0

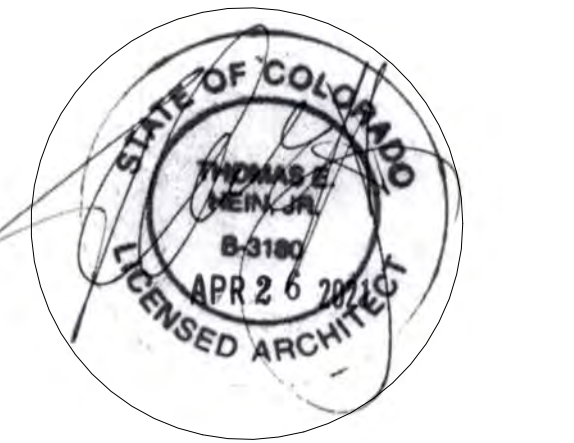

Submissions

DRB REVIEW	20.08.06
PRICING SET	20.08.24
TAGS & SCHEDULES	20.09.08
DRB FINAL REVIEW	20.09.24
CHECK SET	21.04.15
DRB RE-REVIEW SET	21.04.26



ADDITION

LOT 424
121 TOUCHDOWN DR., MOUNTAIN VILLAGE

MAIN LEVEL

CONTRACTOR TO REVIEW AND COMPARE ALL CHAPTERS AND INTERDISCIPLINARY DRAWINGS AND REPORT ANY DISCREPANCIES TO THE ARCHITECT PRIOR TO ANY FIELD WORK BEING DONE IN ACCORDANCE WITH AIA DOCUMENT A201

A2.1

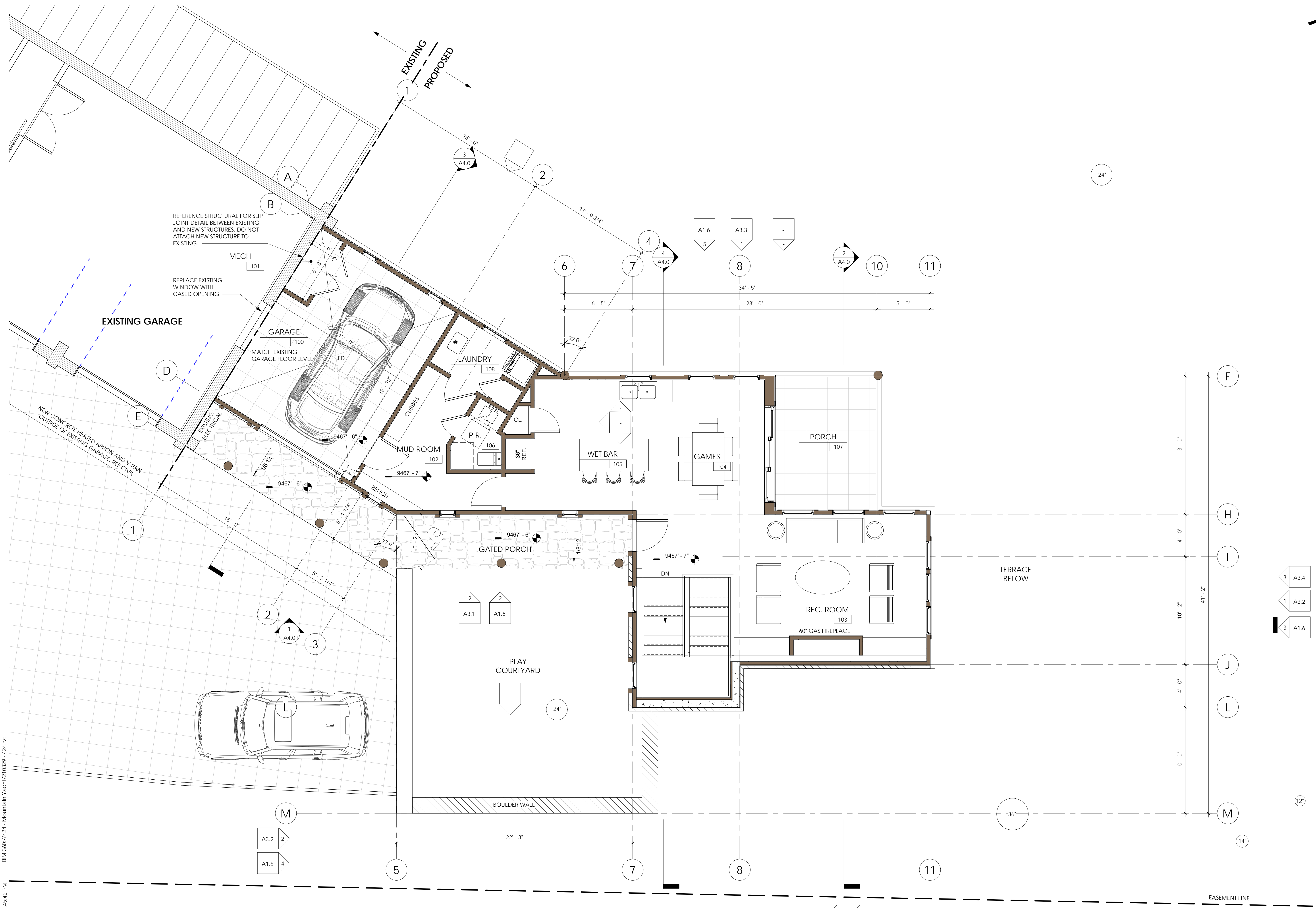

1 Level 1
SCALE 1/4" = 1'-0"

Plot Time 4/26/2021 2:45:42 PM
BM 360/J/424 - Mountain Yacht/210329 - 424.rvt

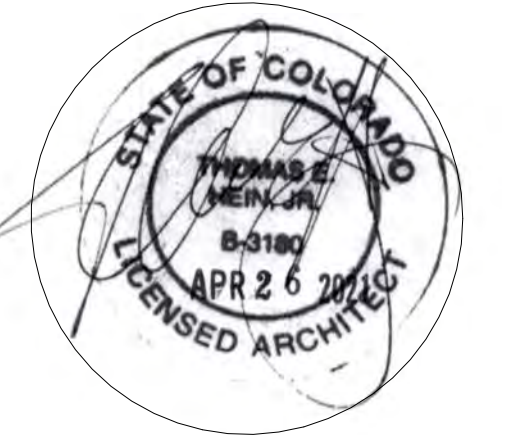

Submissions

DRB REVIEW	20.08.06
PRICING SET	20.08.24
TAGS & SCHEDULES	20.09.08
DRB FINAL REVIEW	20.09.24
CHECK SET	21.04.15
DRB RE-REVIEW SET	21.04.26

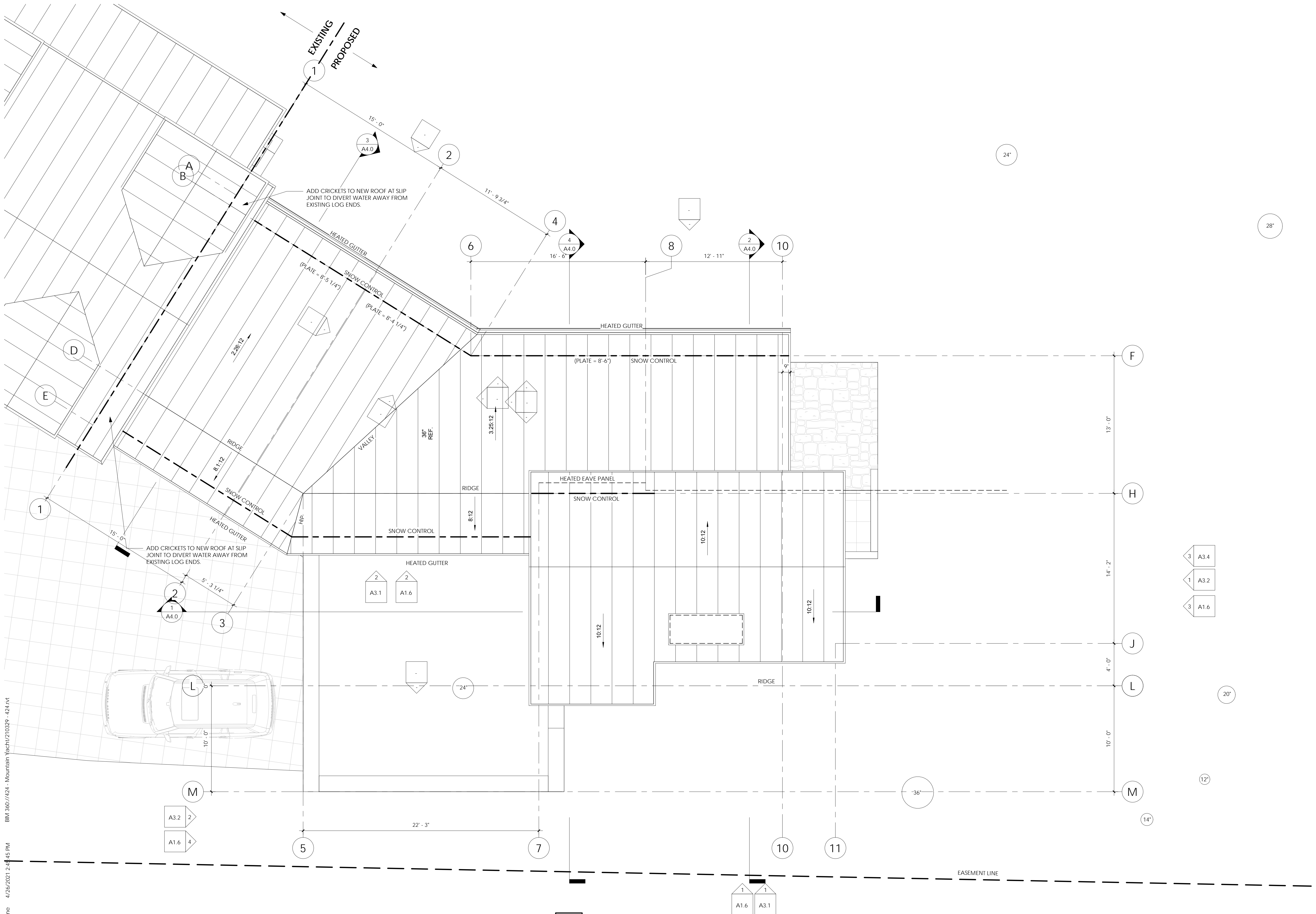

1 Roof Plan

SCALE 1/4" = 1'-0"

Plot Time: 4/26/2021 2:45 PM
BM 360/1424 - Mountain Yacht/210529 - 424.rvt



ADDITION

LOT 424
121 TOUCHDOWN
DR., MOUNTAIN
VILLAGE

ROOF PLAN

CONTRACTOR TO REVIEW AND COMPARE ALL CHAPTERS AND INTERDISCIPLINARY DRAWINGS AND REPORT ANY DISCREPANCIES TO THE ARCHITECT PRIOR TO ANY FIELD WORK BEING DONE IN ACCORDANCE WITH AIA DOCUMENT A201

A2.2

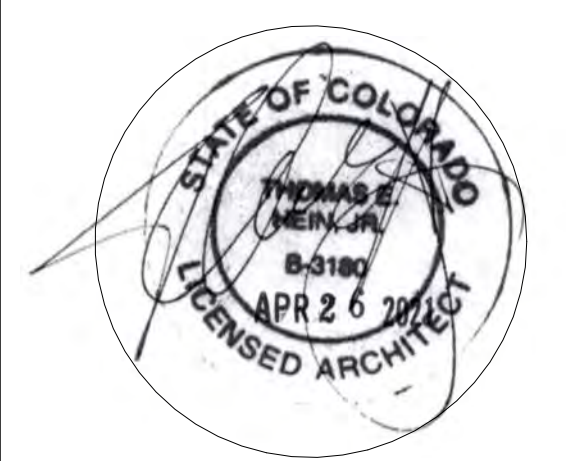

STONE VENEER

EXISTING - VARIABLE COLOR AND PATTERN TO BE DUPLICATED FOR ADDITION CONTRACTOR TO PROVIDE MOCK-UP FOR OWNER APPROVAL

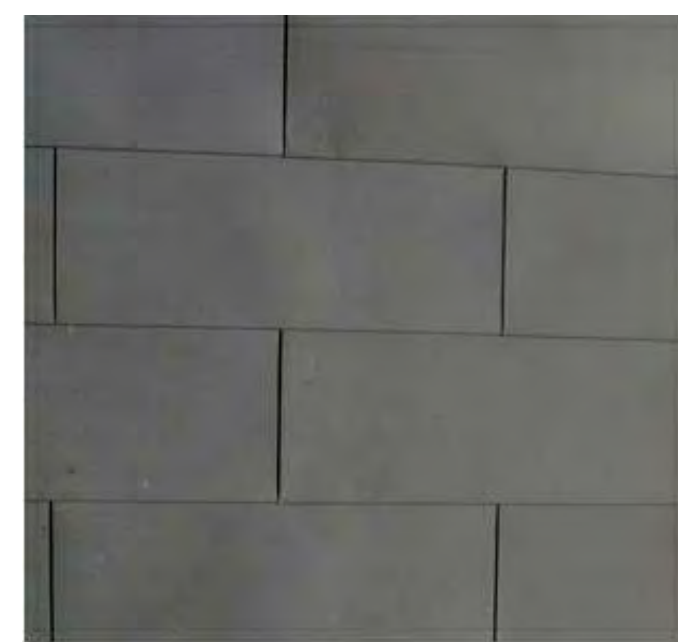

STEEL PANELS

DARK GREY ANNOIDIZED 12X24 STRAIGHT LAY FOR CHIMNEY



HORIZONTAL LOG SIDING

424 2x8 LOG SIDING - SHIP-LAP, HEWNED AND STAINED "REDWOOD" TONE

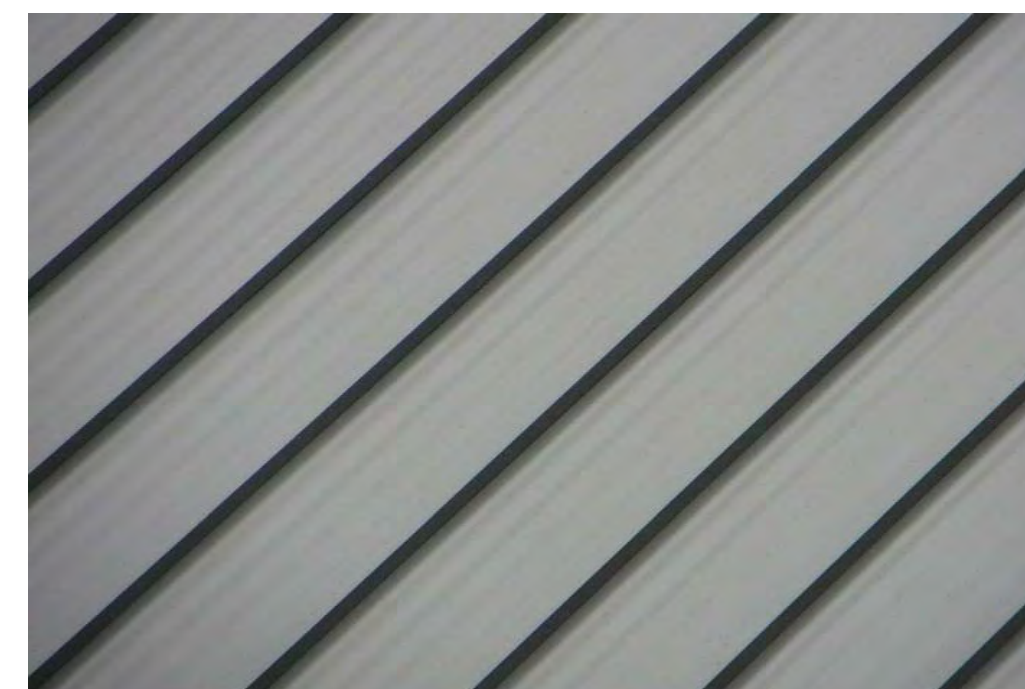

NEW METAL ROOFING - STANDING SEAM

LIGHT GRAY BONDERIZED STANDING SEAM FOR ADDITION



VERTICAL STEEL SIDING

12" x 24" STEEL PANELS LIGHT GREY PATINA

Submissions

DRB REVIEW	20.08.06
PRICING SET	20.08.24
TAGS & SCHEDS	20.09.08
DRB FINAL REVIEW	20.09.24
CHECK SET	21.04.15
DRB RE-REVIEW SET	21.04.26

MATERIAL LEGEND

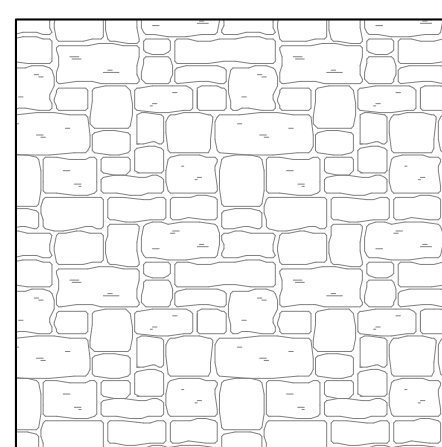

STONE

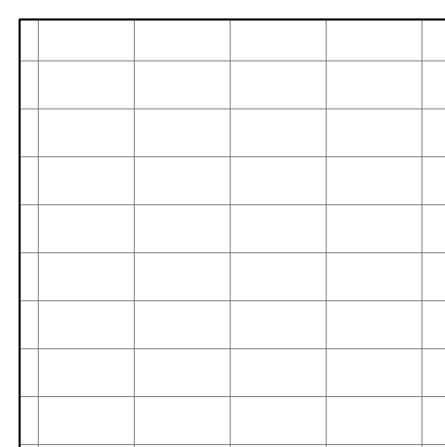

STEEL PANELS



HORIZONTAL SIDING WOOD

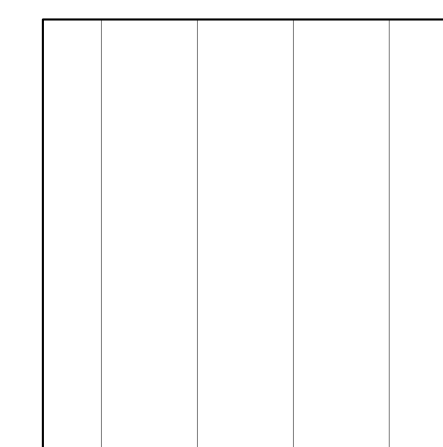

STANDING SEAM

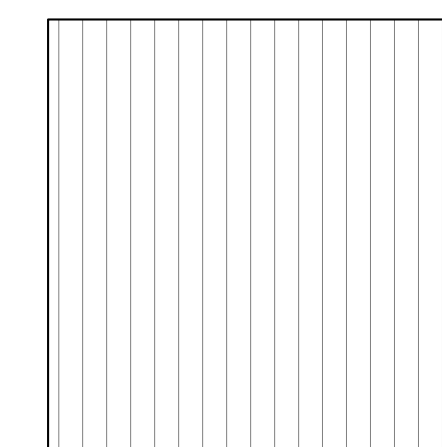

VERTICAL SIDING STEEL

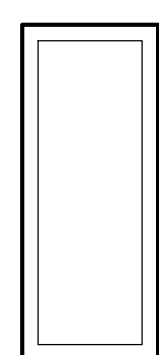

SOLID PANEL DOORS AT ENTRY AND GARAGE

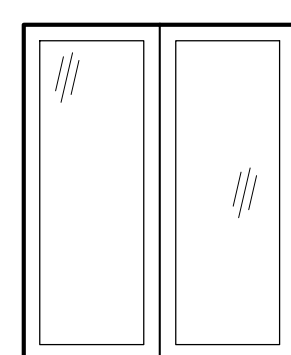

SLIDING/STACKING PATIO DOOR

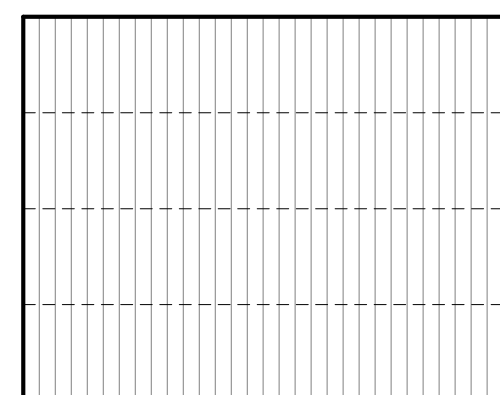

OVERHEAD DOOR WITH STEEL PANELS W/ PATINA FINISH

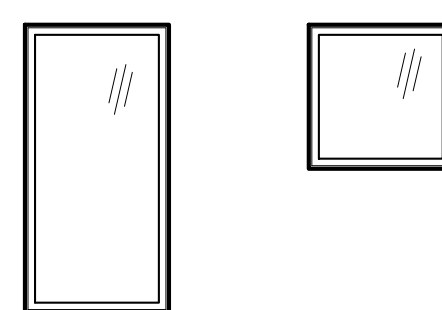

VERTICALLY ORIENTED OR SQUARE CASEMENT AND FIXED METAL CLAD WOOD WINDOWS

1 DOOR AND WINDOW TYPES

SCALE 0 1 2 3 4 1/4" = 1'-0"

WINDOW CUT SHEETS - METAL CLAD - DARK BRONZE ANODIZED FINISH

CONTEMPORARY HARDWARE

Use the corner handle of a picture window when the lock, key and flap handle that can be replaced with the same handle and mount using simple tools.

CONTEMPORARY FINISH

The use of the Contemporary Finish gives a clean, clear and crisp look to the exterior of the window. This is a wide range of colors and finishes, including the classic bronze and black.

HARDWARE

Hardware is a key part of the window and is available in a variety of finishes. This is a wide range of colors and finishes, including the classic bronze and black.

EXTRACTABLE SCREENS

Extractable screens are available in a variety of finishes and are designed with a unique design to fit the window frame. The edge of the screen is fully recessed within the horizontal rail frame and will not be visible when the screen is in place.

COLORS AND FINISHES

Colors and finishes are available in a variety of colors and finishes. The use of the Contemporary Finish gives a clean, clear and crisp look to the exterior of the window. This is a wide range of colors and finishes, including the classic bronze and black.

METALLIC FINISHES

Metallized finishes provide the perfect finishing touch for the exterior of the window. The use of the Contemporary Finish gives a clean, clear and crisp look to the exterior of the window. This is a wide range of colors and finishes, including the classic bronze and black.

Typical Window Style / Frame / and Manufacturer

Loewen



TERRACE CONCRETE

DAVIS COLORED CONCRETE - "OUTBACK" #677 SCORE PATTERN PER SHT. A2.4

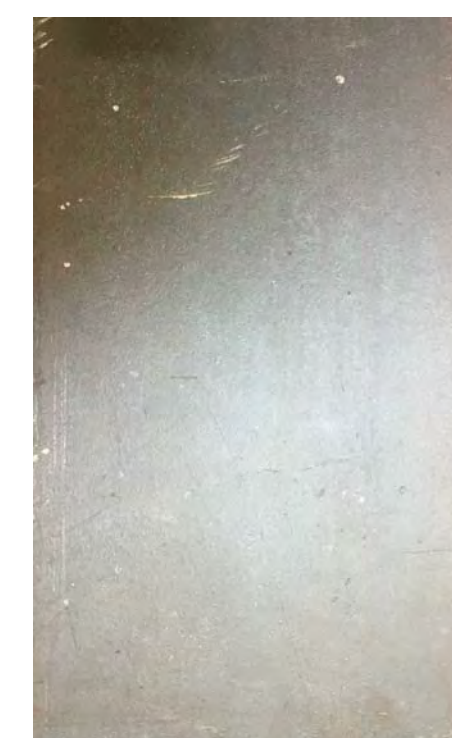

STEEL PLATE - RETAINING WALL

PATINATED FINISH



STEEL - TRIM & PORCHES

PAINTED DARK GRAY



EXISTING LOGS

EXISTING - RESTAIN WITH "REDWOOD" TONE



ADDITION

LOT 424
121 TOUCHDOWN DR., MOUNTAIN VILLAGE

EXTERIOR MATERIALS

CONTRACTOR TO REVIEW AND COMPARE ALL CHAPTERS AND INTERDISCIPLINARY DRAWINGS AND REPORT ANY DISCREPANCIES TO THE ARCHITECT PRIOR TO ANY FIELD WORK BEING DONE IN ACCORDANCE WITH AIA DOCUMENT A201

A3.0

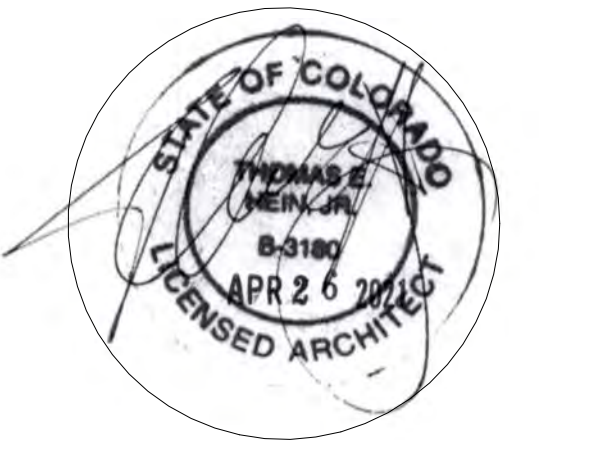

Submissions

DRB REVIEW	20.08.06
PRICING SET	20.08.24
TAGS & SCHEDS	20.09.08
DRB FINAL REVIEW	20.09.24
CHECK SET	21.04.15
DRB RE-REVIEW SET	21.04.26

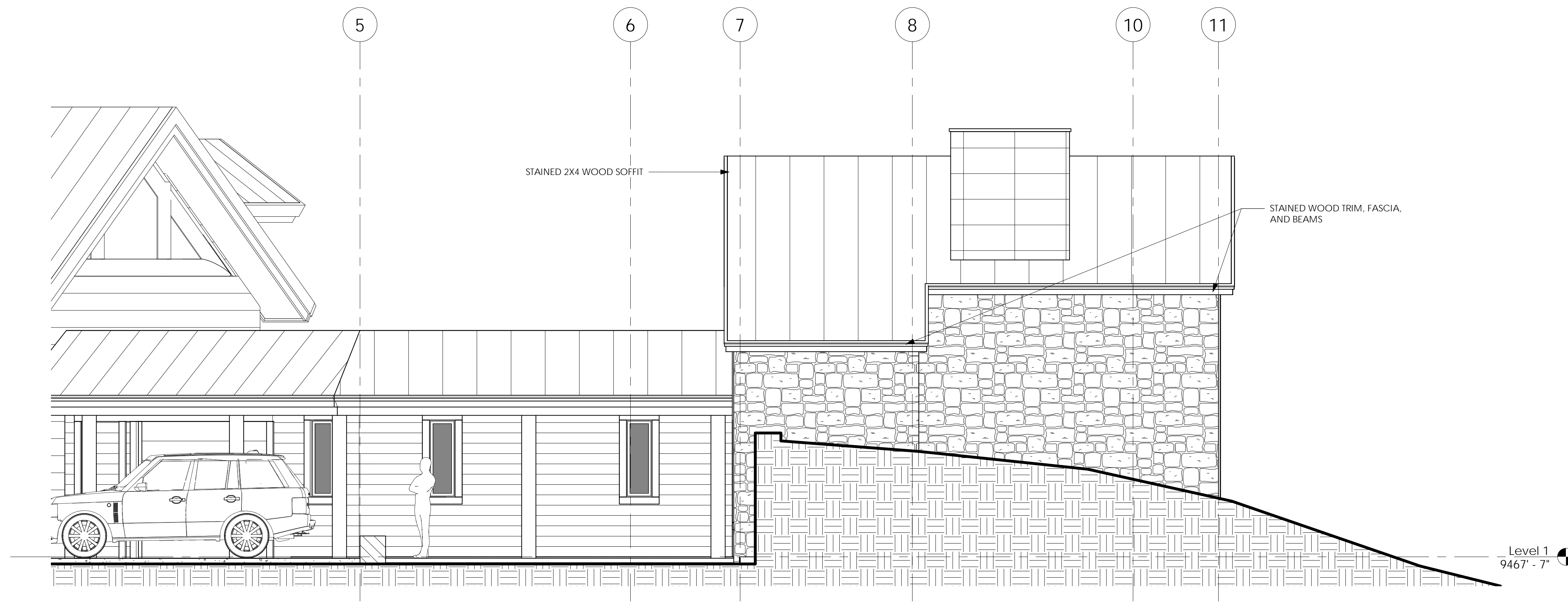

1 East Elevation
SCALE 0 1 2 3 4 1/4" = 1'-0"

NOTE:
Unenclosed accessory structures attached to buildings with habitable spaces and projections, such as decks, shall be constructed as either non-combustible, heavy timber or exterior grade ignition resistant materials such as those listed as WUIC (Wildland Urban Interface Code) approved products

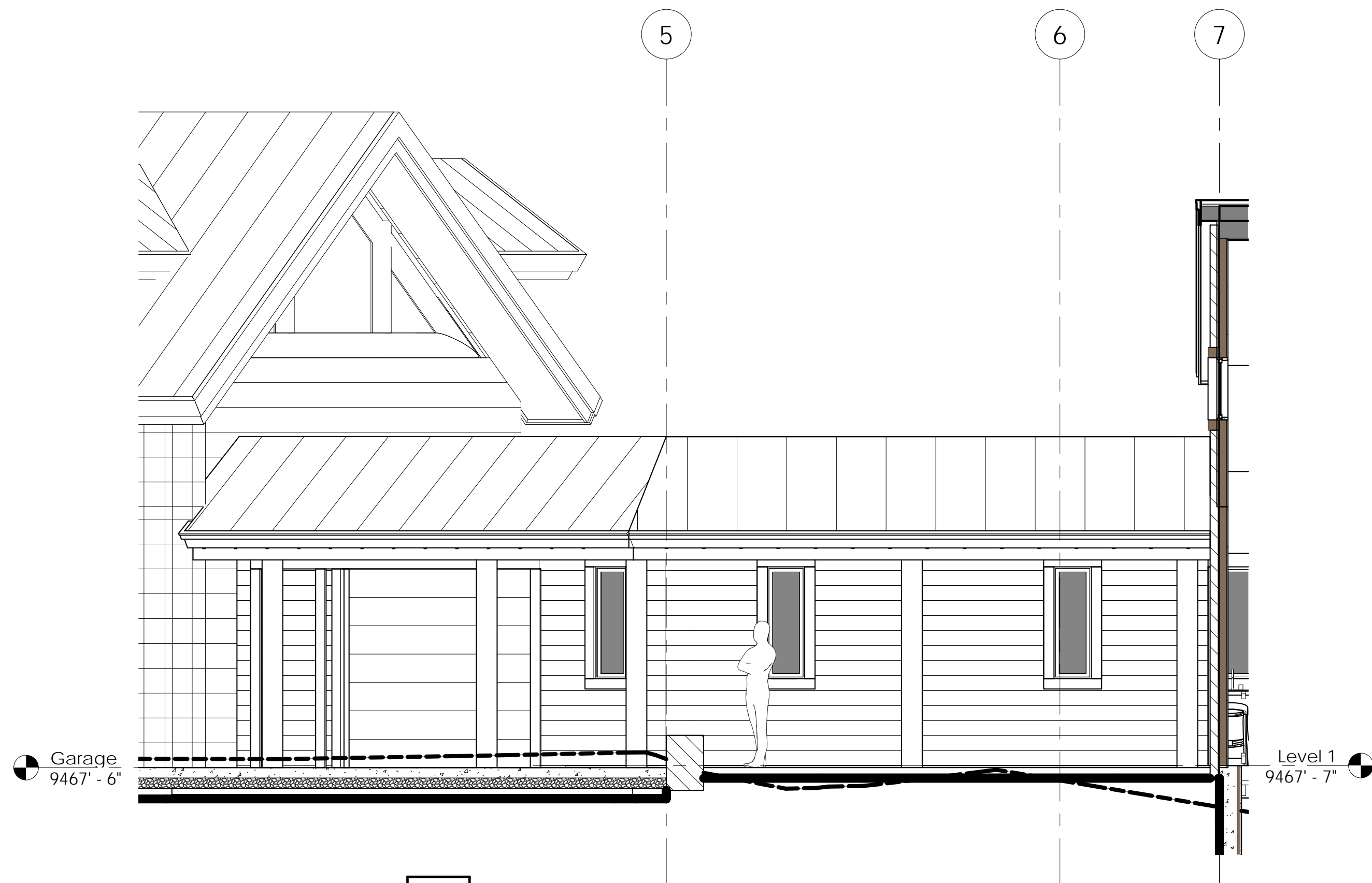

2 East Elevation Partial
SCALE 0 1 2 3 4 1/4" = 1'-0"

MATERIAL LEGEND

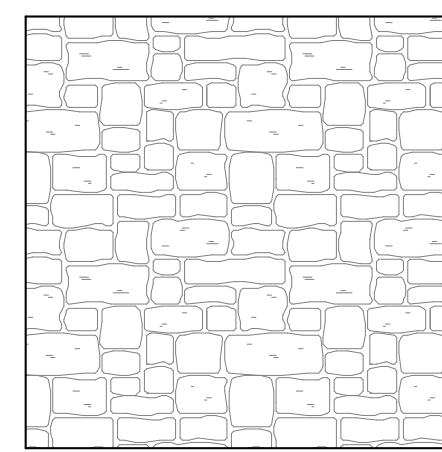

STONE

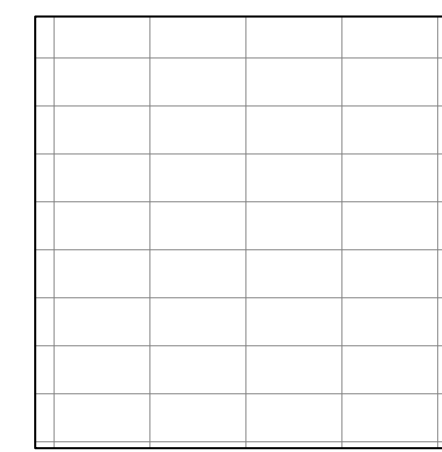

STEEL PANELS



HORIZONTAL SIDING WOOD

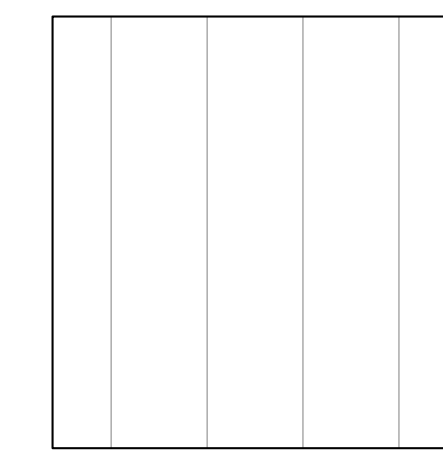

STANDING SEAM

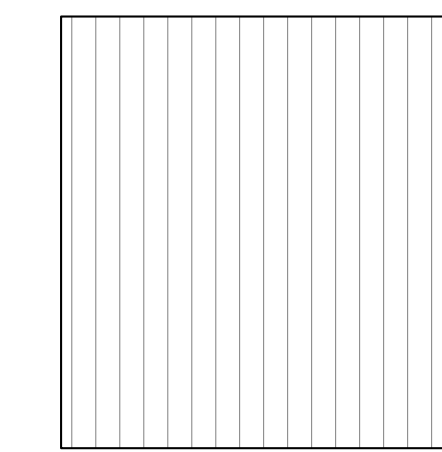

VERTICAL SIDING STEEL



ADDITION

LOT 424
121 TOUCHDOWN
DR., MOUNTAIN
VILLAGE

EXTERIOR ELEVATIONS

CONTRACTOR TO REVIEW AND COMPARE ALL CHAPTERS AND INTERDISCIPLINARY DRAWINGS AND REPORT ANY DISCREPANCIES TO THE ARCHITECT PRIOR TO ANY FIELD WORK BEING DONE IN ACCORDANCE WITH AIA DOCUMENT A201

A3.1

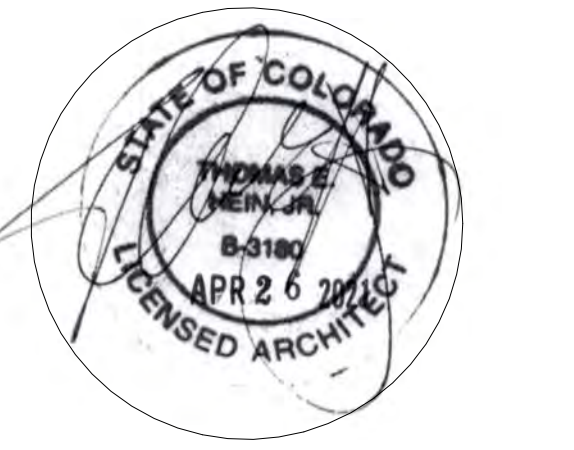

Submissions

DRB REVIEW	20.08.06
PRICING SET	20.08.24
TAGS & SCHEDULES	20.09.08
DRB FINAL REVIEW	20.09.24
CHECK SET	21.04.15
DRB RE-REVIEW SET	21.04.26



1 North Elevation

SCALE 1/4" = 1'-0"

NOTE:
Unenclosed accessory structures attached to buildings with habitable spaces and projections, such as decks, shall be constructed as either non-combustible, heavy timber or exterior grade ignition resistant materials such as those listed as WUIC (Wildland Urban Interface Code) approved products

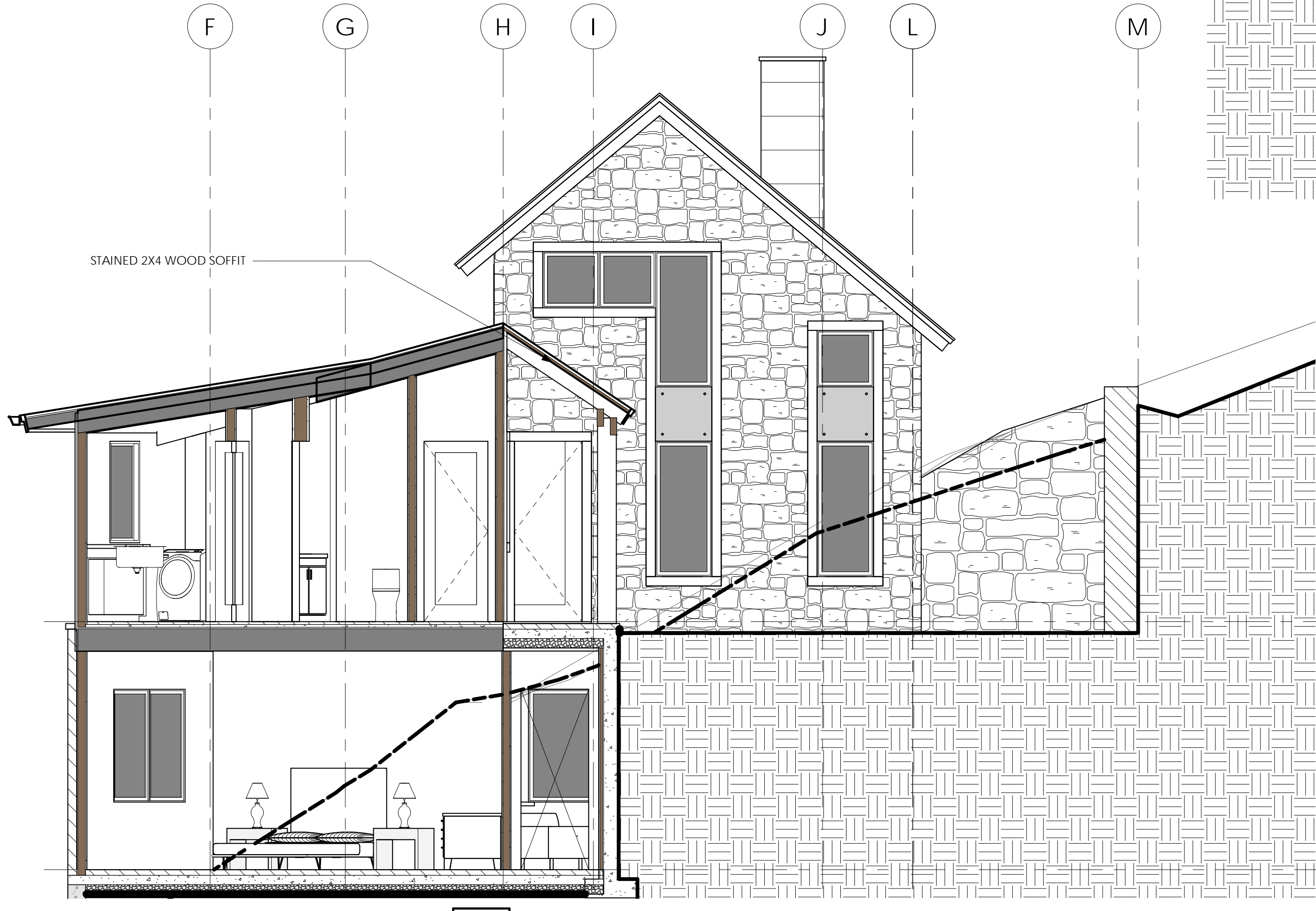

2 South Elevation

SCALE 1/4" = 1'-0"

MATERIAL LEGEND

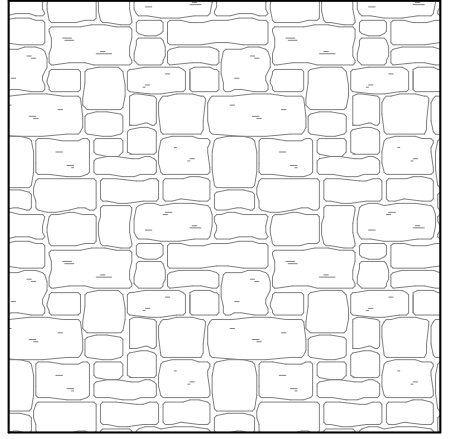
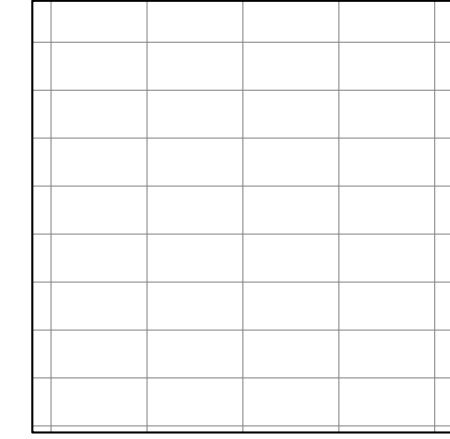
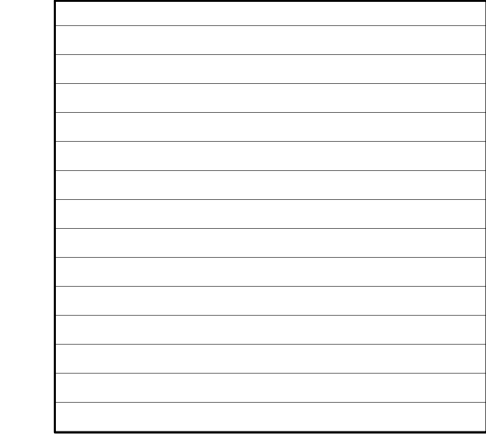
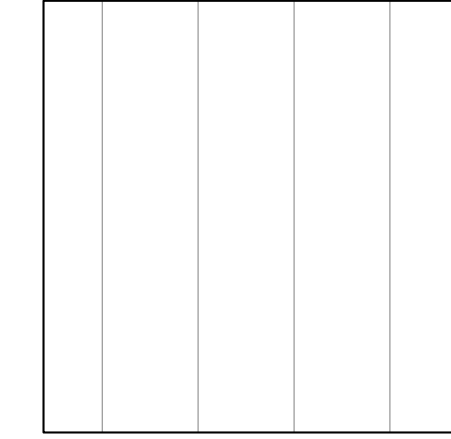
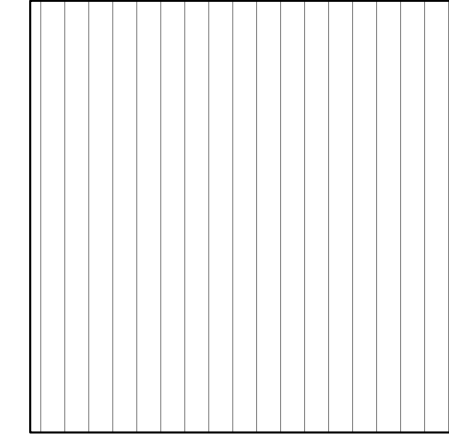
				
STONE	STEEL PANELS	HORIZONTAL SIDING WOOD	STANDING SEAM	VERTICAL SIDING STEEL



ADDITION

LOT 424
121 TOUCHDOWN DR., MOUNTAIN VILLAGE

EXTERIOR ELEVATIONS

CONTRACTOR TO REVIEW AND COMPARE ALL CHAPTERS AND INTERDISCIPLINARY DRAWINGS AND REPORT ANY DISCREPANCIES TO THE ARCHITECT PRIOR TO ANY FIELD WORK BEING DONE IN ACCORDANCE WITH AIA DOCUMENT A201

A3.2

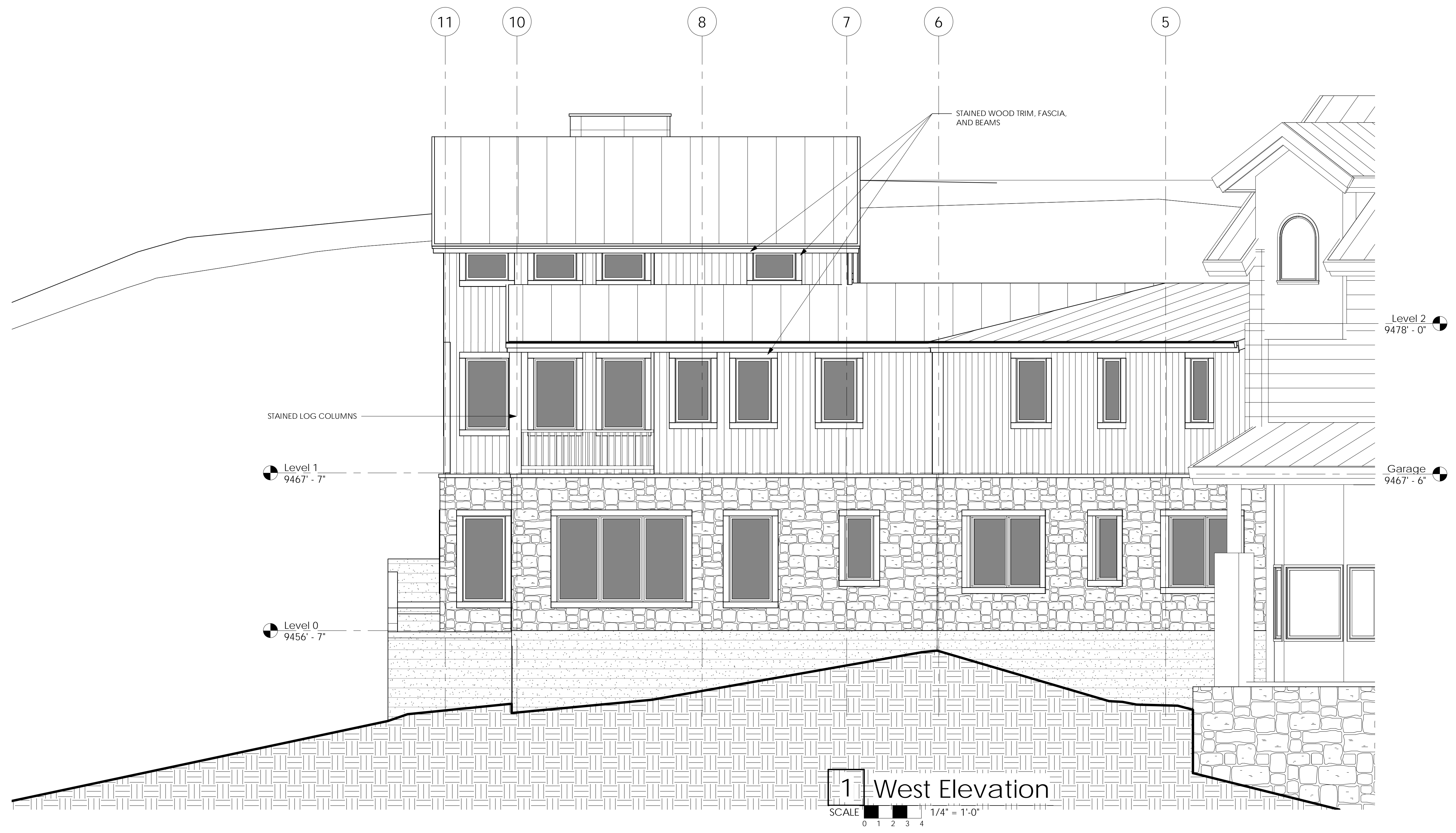
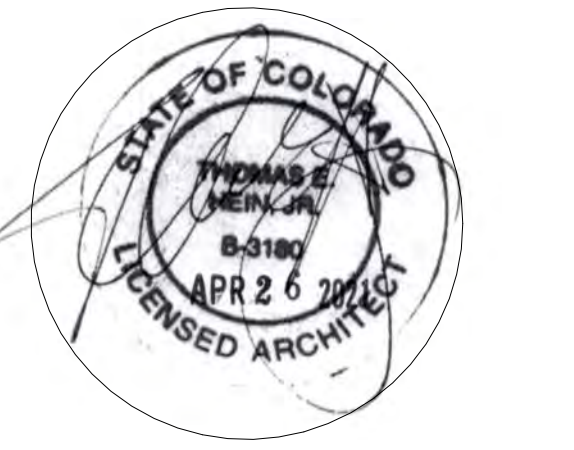

MATERIAL LEGEND

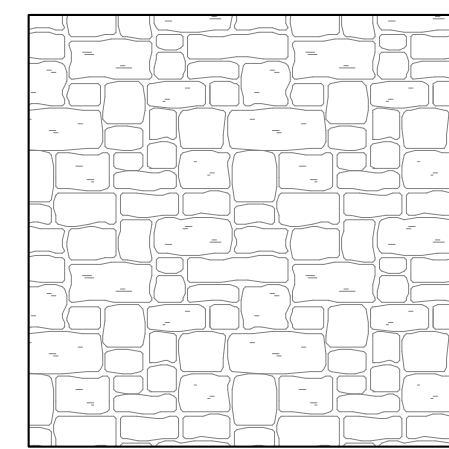

STONE

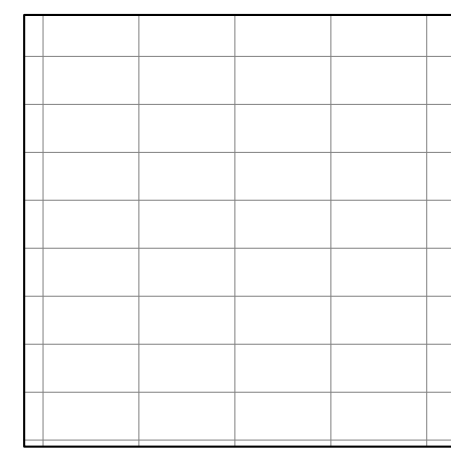

STEEL PANELS



HORIZONTAL SIDING WOOD

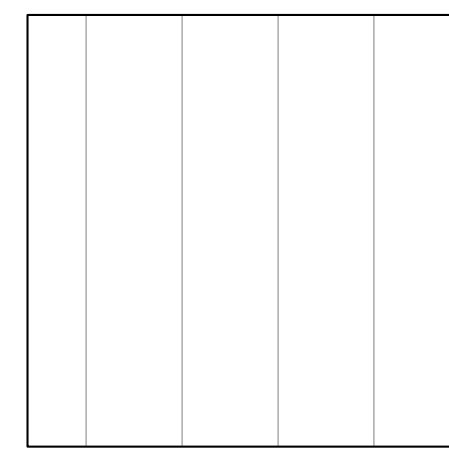

STANDING SEAM

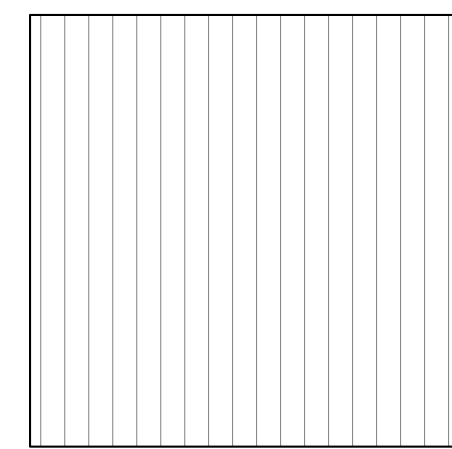

VERTICAL SIDING STEEL

NOTE:
Unenclosed accessory structures attached to buildings with habitable spaces and projections, such as decks, shall be constructed as either non-combustible, heavy timber or exterior grade ignition resistant materials such as those listed as WUIC (Wildland Urban Interface Code) approved products

Submissions

DRB REVIEW	20.08.06
PRICING SET	20.08.24
TAGS & SCHEDULES	20.09.08
DRB FINAL REVIEW	20.09.24
CHECK SET	21.04.15
DRB RE-REVIEW SET	21.04.26



ADDITION

LOT 424
121 TOUCHDOWN
DR., MOUNTAIN
VILLAGE

EXTERIOR ELEVATIONS

CONTRACTOR TO REVIEW AND COMPARE ALL CHAPTERS AND INTERDISCIPLINARY DRAWINGS AND REPORT ANY DISCREPANCIES TO THE ARCHITECT PRIOR TO ANY FIELD WORK BEING DONE IN ACCORDANCE WITH AIA DOCUMENT A201

A3.3

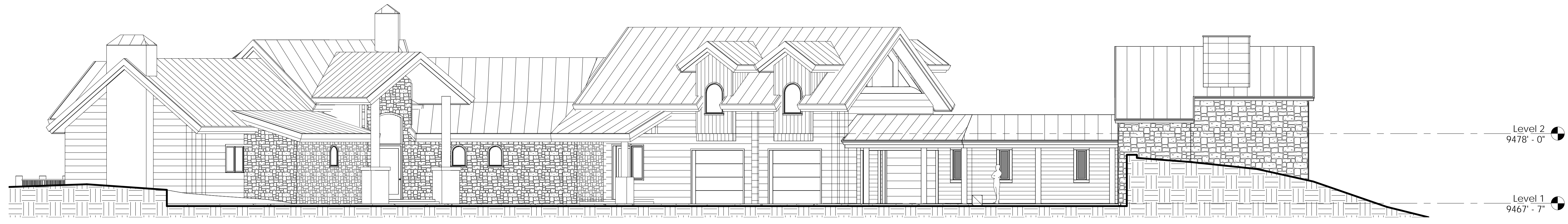
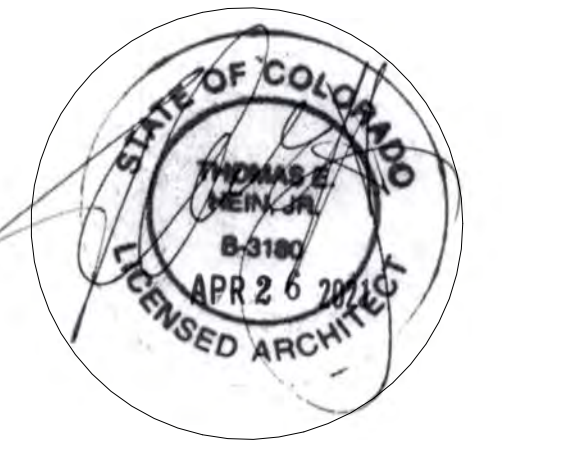

1 Overall - East Elevation
SCALE 0 1/2 4 8 1/8" = 1'-0"



2 Overall - West Elevation
SCALE 0 1/2 4 8 1/8" = 1'-0"

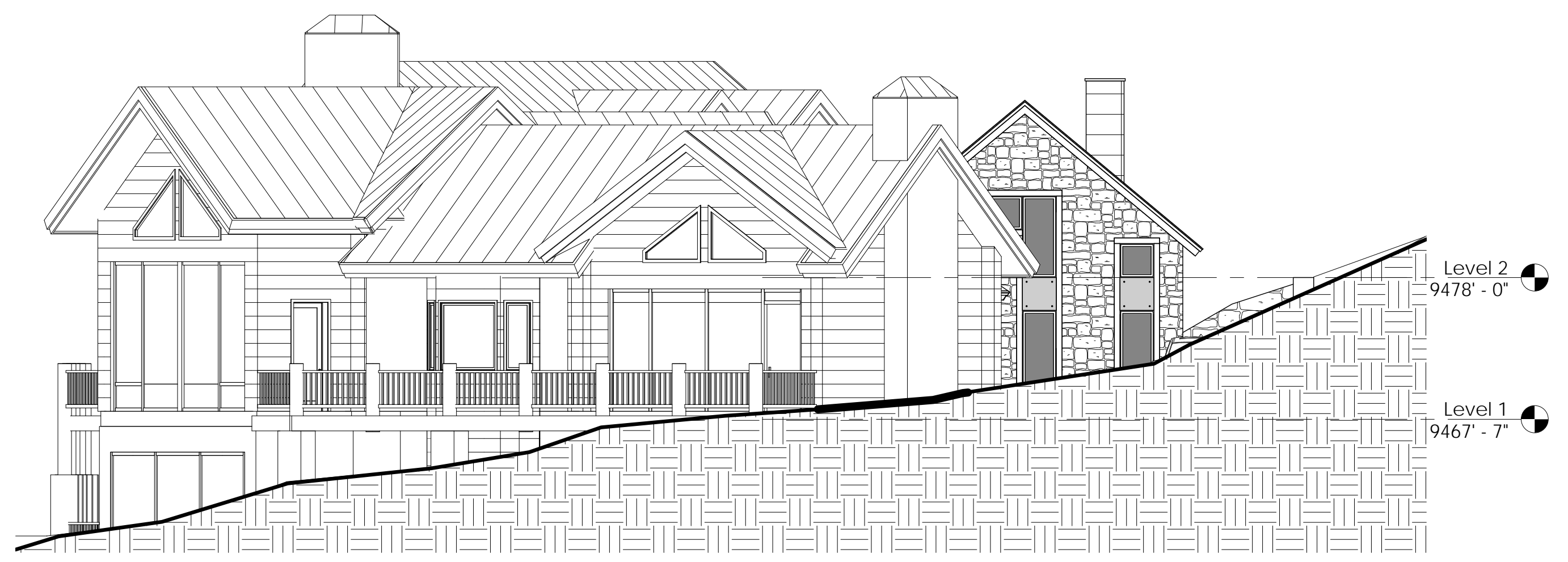

4 Overall - South Elevation
SCALE 0 1/2 4 8 1/8" = 1'-0"



3 Overall - North Elevation
SCALE 0 1/2 4 8 1/8" = 1'-0"

Submissions

DRB REVIEW	20.08.06
PRICING SET	20.08.24
TAGS & SCHEDS	20.09.08
DRB FINAL REVIEW	20.09.24
CHECK SET	21.04.15
DRB RE-REVIEW SET	21.04.26



ADDITION

LOT 424
121 TOUCHDOWN
DR., MOUNTAIN
VILLAGE

**OVERALL
ELEVATIONS**

CONTRACTOR TO REVIEW AND COMPARE ALL CHAPTERS AND INTERDISCIPLINARY DRAWINGS AND REPORT ANY DISCREPANCIES TO THE ARCHITECT PRIOR TO ANY FIELD WORK BEING DONE IN ACCORDANCE WITH AIA DOCUMENT A201

A3.4

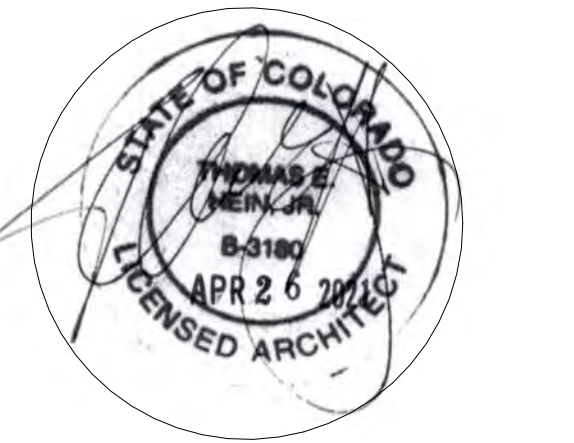

Submissions

DRB REVIEW	20.08.06
PRICING SET	20.08.24
TAGS & SCHEDS	20.09.08
DRB FINAL REVIEW	20.09.24
CHECK SET	21.04.15
DRB RE-REVIEW SET	21.04.26

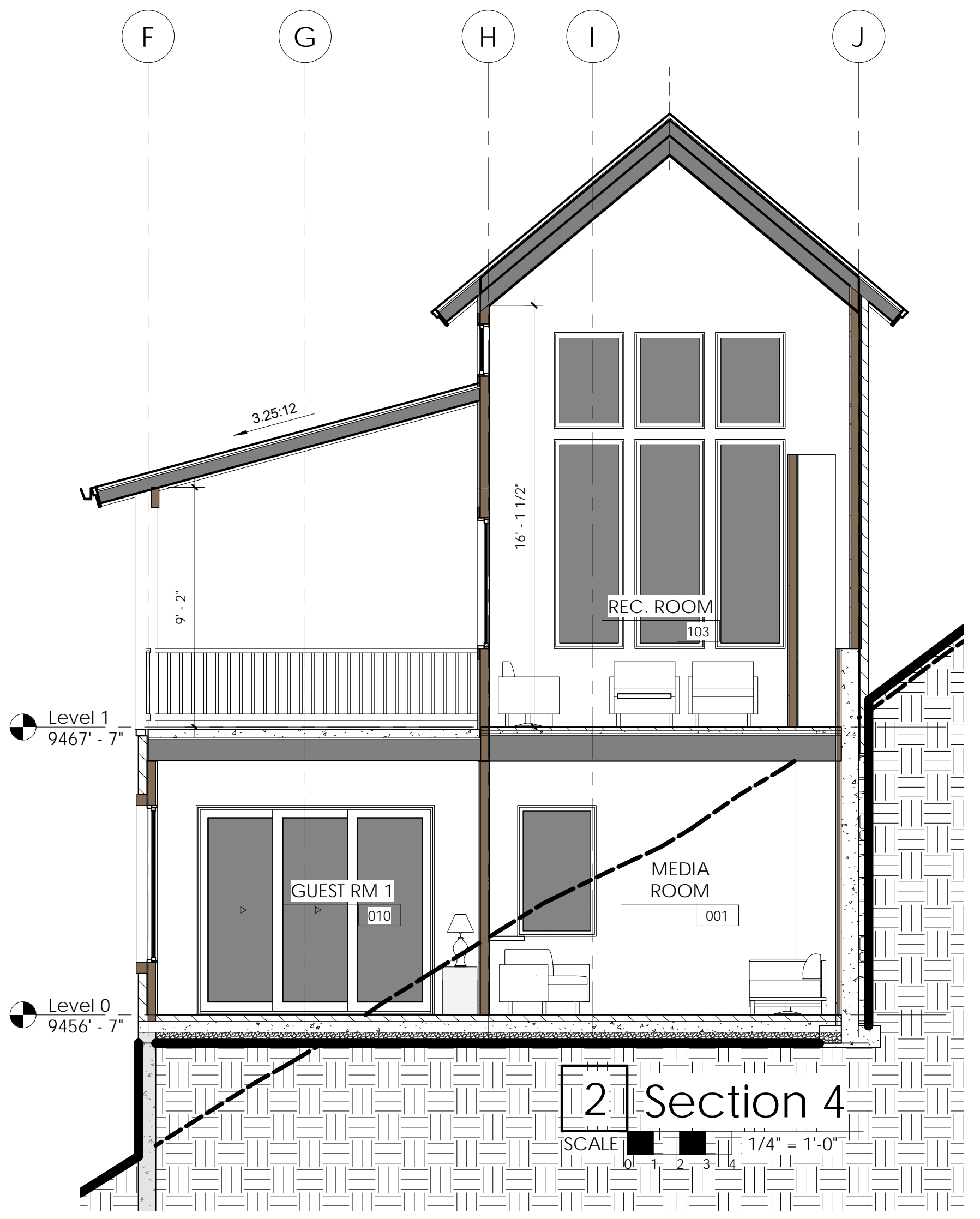
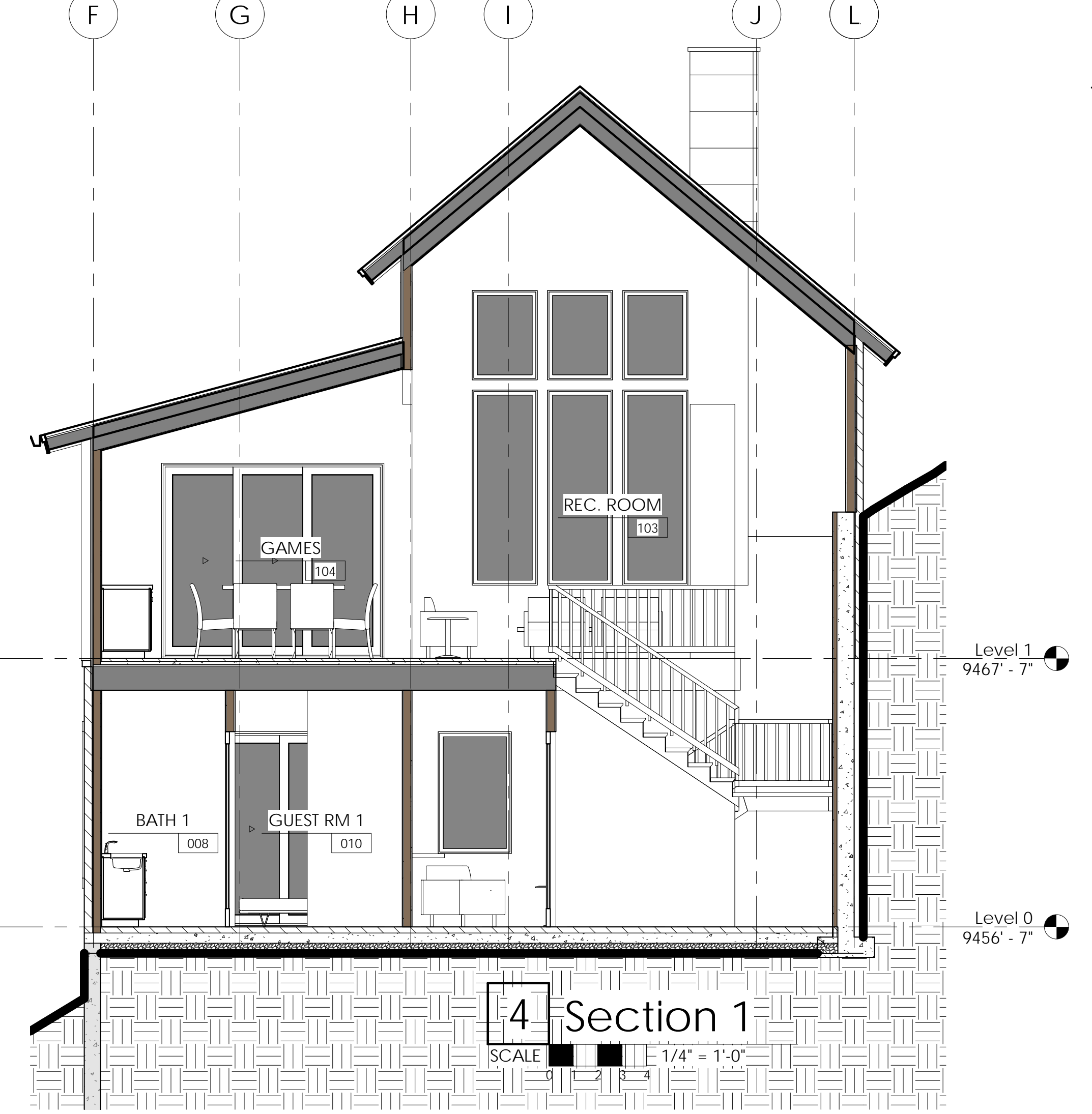
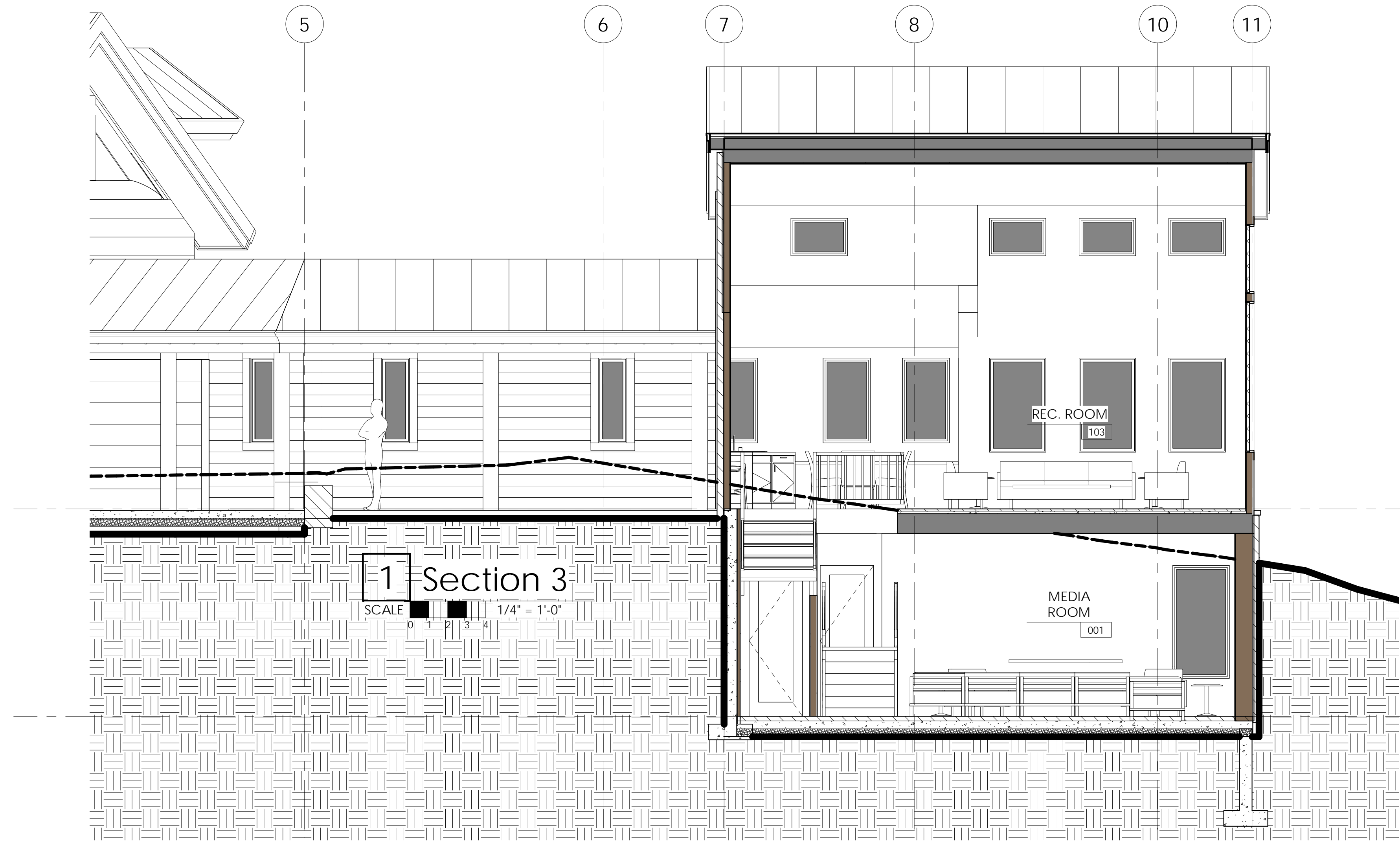

NOTE:
Unenclosed accessory structures attached to buildings with habitable spaces and projections, such as decks, shall be constructed as either non-combustible, heavy timber or exterior grade ignition resistant materials such as those listed as WUIC (Wildland Urban Interface Code) approved products

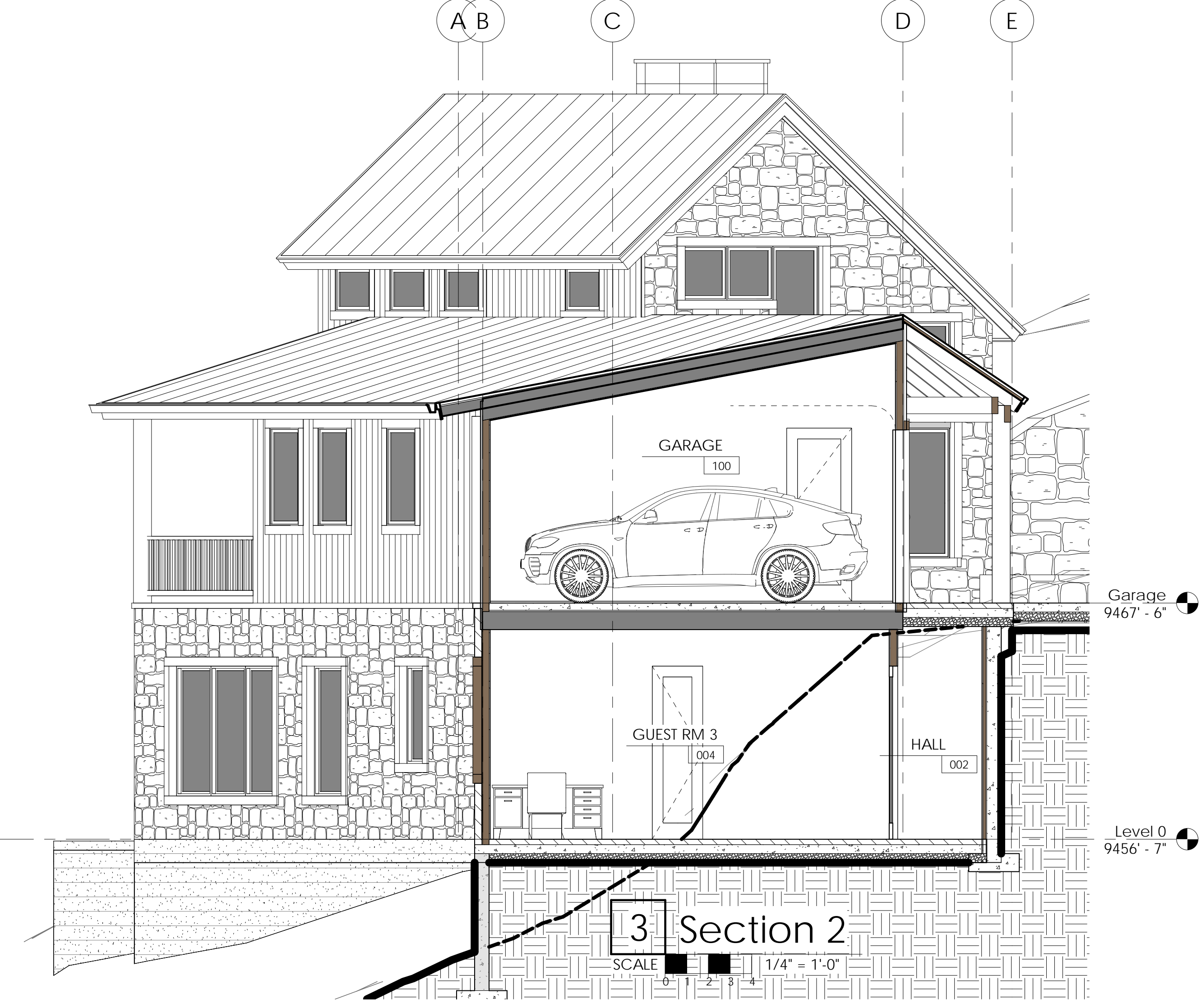

ADDITION

LOT 424
121 TOUCHDOWN DR., MOUNTAIN VILLAGE

BUILDING SECTIONS

CONTRACTOR TO REVIEW AND COMPARE ALL CHAPTERS AND INTERDISCIPLINARY DRAWINGS AND REPORT ANY DISCREPANCIES TO THE ARCHITECT PRIOR TO ANY FIELD WORK BEING DONE IN ACCORDANCE WITH AIA DOCUMENT A201

A4.0

Window Schedule							
Tag	Level	Width	Height	Finish Frame Height	Operation	Head/Jamb/Sill	Comments
001.01	Level 0	3' - 0"	5' - 0"	8' - 0"	Casement		
001.02	Level 0	3' - 0"	6' - 0"	8' - 0"	Casement		
004.01	Level 0	3' - 0"	5' - 0"	8' - 0"	Casement		
004.02	Level 0	3' - 0"	5' - 0"	8' - 0"	Casement		
005.01	Level 0	2' - 0"	4' - 6"	8' - 0"	Casement		
007.01	Level 0	3' - 0"	5' - 0"	8' - 0"	Casement		
007.02	Level 0	3' - 0"	5' - 0"	8' - 0"	Casement		
008.01	Level 0	2' - 0"	4' - 6"	8' - 0"	Casement		
010.01	Level 0	3' - 0"	6' - 0"	8' - 0"	Casement		
010.02	Level 0	3' - 0"	6' - 0"	8' - 0"	Casement		
010.03	Level 0	3' - 0"	6' - 0"	8' - 0"	Casement		
010.04	Level 0	3' - 0"	6' - 0"	8' - 0"	Casement		
100.01	Garage	1' - 6"	4' - 6"	8' - 1"	Casement		
100.02	Garage	1' - 6"	4' - 6"	8' - 1"	Casement		
102.01	Level 1	1' - 6"	4' - 6"	8' - 0"	Casement		
102.02	Level 1	1' - 6"	4' - 6"	8' - 0"	Casement		
103.01	Level 1	3' - 0"	5' - 0"	8' - 0"	Casement		
103.02	Level 1	3' - 0"	5' - 0"	8' - 0"	Casement		
103.03	Level 1	3' - 0"	5' - 0"	8' - 0"	Casement		
103.04	Level 1	2' - 8"	8' - 0"	11' - 0"	Casement		
103.05	Level 1	2' - 8"	8' - 0"	11' - 0"	Casement		
103.06	Level 1	2' - 8"	8' - 0"	11' - 0"	Casement		
103.07	Level 1	2' - 6"	6' - 0"	8' - 0"	Casement		
103.08	Level 1	2' - 6"	6' - 0"	8' - 0"	Casement		
103.09	Level 2	3' - 0"	2' - 0"	5' - 0"	Casement		
103.10	Level 2	3' - 0"	2' - 0"	5' - 0"	Casement		
103.11	Level 2	3' - 0"	2' - 0"	5' - 0"	Casement		
103.12	Level 2	3' - 0"	2' - 0"	5' - 0"	Casement		
103.13	Level 2	2' - 8"	3' - 8"	4' - 8"	Casement		
103.14	Level 2	2' - 8"	3' - 8"	4' - 8"	Casement		
103.15	Level 2	2' - 8"	3' - 8"	4' - 8"	Casement		
103.16	Level 2	2' - 6"	2' - 6"	2' - 6"	Casement		
103.17	Level 2	2' - 6"	6' - 0"	6' - 0"	Casement		
103.18	Level 2	2' - 6"	2' - 6"	6' - 0"	Fixed		
103.19	Level 2	2' - 6"	2' - 6"	6' - 0"	Fixed		
104.01	Level 1	2' - 6"	4' - 6"	8' - 0"	Casement		
104.02	Level 1	2' - 6"	4' - 6"	8' - 0"	Casement		
105.01	Level 1	2' - 6"	4' - 6"	8' - 0"	Casement		
105.02	Level 1	1' - 6"	4' - 6"	8' - 0"	Casement		
108.01	Level 1	2' - 6"	4' - 6"	8' - 0"	Casement		

Door Schedule - Interior Doors					
Tag	Level	Height	Width	Head/Jamb/Sill	Comments
0	Level 0	0"	0"		
001.1	Level 0	8' - 0"	2' - 10"		
003.1	Level 0	8' - 0"	2' - 6"		
004.1	Level 0	8' - 0"	2' - 10"		
005.1	Level 0	8' - 0"	2' - 4"		
005.2	Level 0	8' - 0"	2' - 4"		
006.1	Level 0	8' - 0"	2' - 6"		
007.1	Level 0	8' - 0"	2' - 10"		
008.1	Level 0	8' - 0"	2' - 6"		
008.2	Level 0	8' - 0"	2' - 6"		
009.1	Level 0	8' - 0"	2' - 4"		
010.1	Level 0	8' - 0"	2' - 10"		
100.1	Garage	7' - 0"	5' - 0"		Double Swing
102.1	Level 1	8' - 0"	3' - 0"		
102.2	Level 1	8' - 0"	2' - 10"		
105.1	Level 1	8' - 0"	2' - 4"		
106.1	Level 1	8' - 0"	2' - 4"		
108.1	Level 1	8' - 0"	2' - 10"		
108.2	Level 1	8' - 0"	2' - 0"		

Door Schedule - Exterior Doors					
Tag	Level	Height	Width	Head/Jamb/Sill	Comments
010.2e	Level 0	8' - 0"	9' - 0"		
100.2e	Garage	8' - 0"	9' - 0"		Overhead
103.1e	Level 1	8' - 0"	3' - 0"		Door Entry
104.1e	Level 1	8' - 0"	9' - 0"		

Tommy Hein
ARCHITECTS

Box 3327 108 S. OAK ST. PENTHOUSE
TELLURIDE, COLORADO 81435 970.728.1220
WWW.TOMMYHEIN.COM

© COPYRIGHT 2021 TOMMY HEIN ARCHITECT, LLC (THA). THESE ARCHITECTURAL DRAWINGS AND PLANS ARE THE WORK PRODUCT AND CAN NOT BE REPRODUCED OR DUPLICATED WITHOUT THA'S EXPRESS WRITTEN PERMISSION.

Submissions	
DRB REVIEW	20.08.06
PRICING SET	20.08.24
TAGS & SCHEDULES	20.09.08
DRB FINAL REVIEW	20.09.24
CHECK SET	21.04.15
DRB RE-REVIEW SET	21.04.26

Mountain YACHT

ADDITION

LOT 424
121 TOUCHDOWN
DR., MOUNTAIN
VILLAGE

WINDOW AND
DOOR
SCHEDULES

CONTRACTOR TO REVIEW AND COMPARE ALL CHAPTERS AND INTERDISCIPLINARY DRAWINGS AND REPORT ANY DISCREPANCIES TO THE ARCHITECT PRIOR TO ANY FIELD WORK BEING DONE IN ACCORDANCE WITH AIA DOCUMENT A201

A9.1

GENERAL CIVIL ENGINEERING NOTES:

1. THE EXISTING UTILITY LINES SHOWN ON THE PLANS ARE APPROXIMATE. AT LEAST TWO (2) FULL WORKING DAYS PRIOR TO COMMENCING CONSTRUCTION, THE CONTRACTOR SHALL CONTACT THE UTILITY NOTIFICATION CENTER OF COLORADO @ 1-800-922-1987 OR 811 TO GET ALL UTILITIES LOCATED. IF ANY OF THESE UNDERGROUND UTILITIES ARE IN CONFLICT WITH THE CONSTRUCTION PLANS, THE CONTRACTOR SHALL NOTIFY THE ENGINEER AND WORK WITH THE ENGINEER TO FIND A SOLUTION BEFORE THE START OF CONSTRUCTION.

INSTALLATION AND SEPARATION REQUIREMENTS SHALL BE COORDINATED WITH THE INDIVIDUAL UTILITY PROVIDERS.

THE UTILITY PROVIDERS ARE:

SEWER, WATER, CABLE TV AND FIBEROPTIC: TOWN OF MOUNTAIN VILLAGE
NATURAL GAS: BLACK HILLS ENERGY
POWER: SAN MIGUEL POWER
TELEPHONE: CENTURY LINK

2. PRIOR TO BEGINNING ANY CONSTRUCTION ACTIVITIES, ALL NECESSARY PERMITS SHALL BE OBTAINED BY THE OWNER OR CONTRACTOR.

3. IT IS THE CONTRACTOR'S RESPONSIBILITY TO INSURE THAT EXCAVATED SLOPES ARE SAFE AND COMPLY WITH OSHA REQUIREMENTS. REFER TO THE SITE-SPECIFIC REPORT FOR THIS PROJECT FOR ADDITIONAL INFORMATION.

4. ALL TRENCHES SHALL BE ADEQUATELY SUPPORTED OR LAID BACK PER OSHA REGULATIONS.

5. ALL MATERIALS AND CONSTRUCTION SHALL BE IN CONFORMANCE WITH THE TOWN OF MOUNTAIN VILLAGE DESIGN STANDARDS LATEST EDITION. ALL CONSTRUCTION WITHIN EXISTING STREET OR ALLEY RIGHT-OF-WAY SHALL BE SUBJECT TO TOWN OF MOUNTAIN VILLAGE INSPECTION.

6. THE CONTRACTOR SHALL HAVE ONE COPY OF THE STAMPED PLANS ON THE JOB SITE AT ALL TIMES.

7. THE CONTRACTOR SHALL NOTIFY THE TOWN 48 HOURS PRIOR TO THE START OF CONSTRUCTION.

8. THE CONTRACTOR IS RESPONSIBLE FOR IMPLEMENTING AND MAINTAINING EROSION AND SEDIMENT CONTROL MEASURES AT ALL TIMES DURING CONSTRUCTION. THE ADJOINING ROADWAYS SHALL BE FREE OF DEBRIS AT THE END OF CONSTRUCTION ACTIVITIES EACH DAY.

9. THE CONTRACTOR SHALL PROVIDE, ERECT AND MAINTAIN PROPER TRAFFIC CONTROL DEVICES UNTIL THE SITE IS OPEN TO TRAFFIC. ANY TRAFFIC CLOSURES MUST BE COORDINATED WITH THE TOWN OF MOUNTAIN VILLAGE.

10. ALL DAMAGE TO PUBLIC STREETS AND ROADS, INCLUDING HAUL ROUTES, TRAILS, OR STREET IMPROVEMENTS, OR TO PRIVATE PROPERTY, SHALL BE REPAIRED AT THE SOLE EXPENSE OF THE CONTRACTOR TO THE ORIGINAL CONDITIONS.

11. WHEN AN EXISTING ASPHALT STREET IS CUT, THE STREET MUST BE RESTORED TO A CONDITION EQUAL TO OR BETTER THAN ITS ORIGINAL CONDITION. THE FINISHED PATCH SHALL BLEND SMOOTHLY INTO THE EXISTING SURFACE. ALL LARGE PATCHES SHALL BE PAVED WITH AN ASPHALT LAY-DOWN MACHINE.

12. IF DEWATERING IS REQUIRED, THE CONTRACTOR SHALL NOTIFY THE ENGINEER. ANY DISCHARGE REQUIREMENTS SHALL BE COORDINATED WITH THE TOWN OF MOUNTAIN VILLAGE.

13. CONTRACTOR SHALL NOTIFY ALL RESIDENTS IN WRITING 24 HOURS PRIOR TO ANY SHUT-OFF IN SERVICE. THE NOTICES MUST HAVE CONTRACTOR'S PHONE NUMBER AND NAME OF CONTACT PERSON, AND EMERGENCY PHONE NUMBER FOR AFTER HOURS CALLS. ALL SHUT-OFFS MUST BE APPROVED BY THE TOWN AND TOWN VALVES AND APPURTENANCES SHALL BE OPERATED BY TOWN PERSONNEL.

14. CONTRACTOR SHALL KEEP SITE CLEAN AND LITTER FREE (INCLUDING CIGARETTE BUTTS) BY PROVIDING A CONSTRUCTION DEBRIS TRASH CONTAINER AND A BEAR-PROOF POLY-CART TRASH CONTAINER, WHICH IS TO BE LOCKED AT ALL TIMES.

15. CONTRACTOR MUST BE AWARE OF ALL TREES TO REMAIN PER THE DESIGN AND APPROVAL PROCESS AND PROTECT THEM ACCORDINGLY.

16. THE CONTRACTOR SHALL PROVIDE UNDERGROUND UTILITY AS-BUILTS TO THE TOWN.

17. ALL STRUCTURAL FILL UNDER HARDSCAPE OR ROADS MUST BE COMPACTED TO 95% MODIFIED PROCTOR (MIN.) AT PLUS OR MINUS 2% OF THE OPTIMUM MOISTURE CONTENT. NON-STRUCTURAL FILL SHALL BE PLACED AT 90% (MIN.) MODIFIED PROCTOR.

18. UNSUITABLE MATERIAL SHALL BE REMOVED AS REQUIRED BY THE SOILS ENGINEER. ALL MATERIALS SUCH AS LUMBER, LOGS, BRUSH, TOPSOIL OR ORGANIC MATERIALS OR RUBBISH SHALL BE REMOVED FROM ALL AREAS TO RECEIVE COMPACTED FILL.

19. NO MATERIAL SHALL BE COMPACTED WHEN FROZEN.

20. NATIVE TOPSOIL SHALL BE STOCKPILED TO THE EXTENT FEASIBLE ON THE SITE FOR USE ON AREAS TO BE REVEGETATED.

21. THE CONTRACTOR SHALL BE RESPONSIBLE FOR DUST ABATEMENT AND EROSION CONTROL MEASURES DEEMED NECESSARY BY THE TOWN, IF CONDITIONS WARRANT THEM.

22. ALL DISTURBED GROUND SHALL BE RE-SEEDED WITH A TOWN-APPROVED SEED MIX. REFER TO THE LANDSCAPE PLAN.

23. THE CONTRACTOR IS REQUIRED TO PROTECT ALL EXISTING SURVEY MONUMENTS AND PROPERTY CORNERS DURING GRADING AND CONSTRUCTION.

24. ALL UNDERGROUND PIPE SHALL BE PROTECTED WITH BEDDING TO PROTECT THE PIPE FROM BEING DAMAGED.

25. HOT TUBS SHALL DRAIN TO THE SANITARY SEWER (OR PUMPED TO AA CLEAN-OUT).

26. THE UTILITY PLAN DEPICTS FINAL UTILITY LOCATIONS BUT HAS BEEN COMPLETED AT A PRELIMINARY STAGE. CONTRACTOR SHALL VERIFY ALIGNMENTS WITH THE ARCHITECT PRIOR TO CONSTRUCTION.

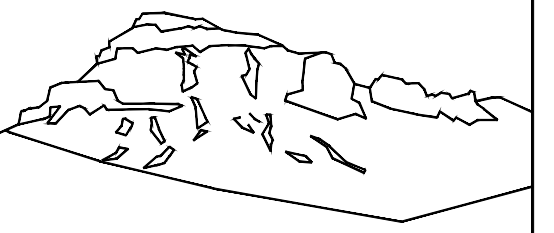

Uncompahgre
Engineering, LLC

P.O. Box 3945
Telluride, CO 81435
970-729-0683

SUBMISSIONS:

DRB SUBMITTAL 2020-08-06

DRB FINAL REVIEW 2020-09-24

Revised Footprints 2021-04-27

Lot 424
Touchdown Drive
Mtn. Village, CO

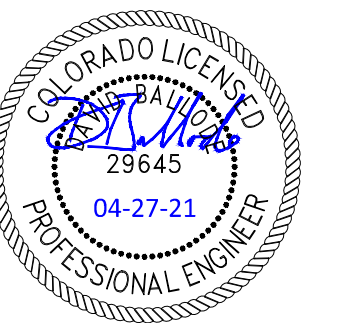

CONTRACTOR TO REVIEW AND COMPARE ALL CHAPTERS AND INTERDISCIPLINARY DRAWINGS AND REPORT ANY DISCREPANCIES TO THE ARCHITECT PRIOR TO ANY FIELD WORK BEING DONE IN ACCORDANCE WITH AIA DOCUMENT A201

Notes

C1

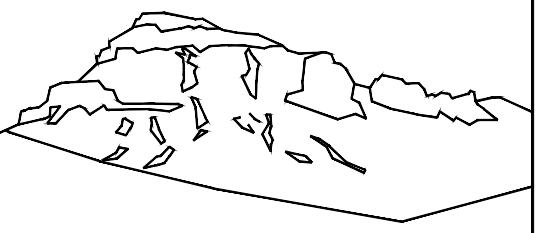

Uncompahgre
Engineering, LLC

P.O. Box 3945
Telluride, CO 81435
970-729-0683

SUBMISSIONS:

DRB SUBMITTAL	2020-08-06
DRB FINAL REVIEW	2020-09-24
Revised Footprints	2021-04-27

Lot 424
Touchdown Drive
Mtn. Village, CO



CONTRACTOR TO REVIEW AND COMPARE ALL
CHAPTERS AND INTERDISCIPLINARY DRAWINGS
AND REPORT ANY DISCREPANCIES TO THE
ARCHITECT PRIOR TO ANY FIELD WORK BEING
DONE IN ACCORDANCE WITH AIA DOCUMENT A201

Grading
and
Drainage
Plan

C2

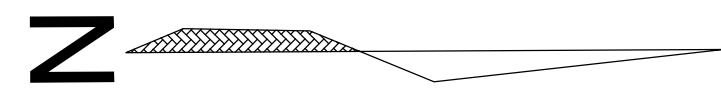
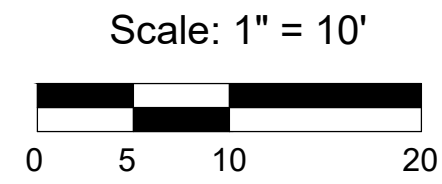

$\Delta=30^{\circ}08'01''$
 $R=324.70'$
 $L=170.77'$
 $ChB=N10^{\circ}55'58''E$
 $ChL=168.81'$

9390

9395

9400

9405

9410

9415

9420

9425

9430

9435

9440

9445

9450

9455

9460

9465

S 88°00'00" E, 180.24' (REC)

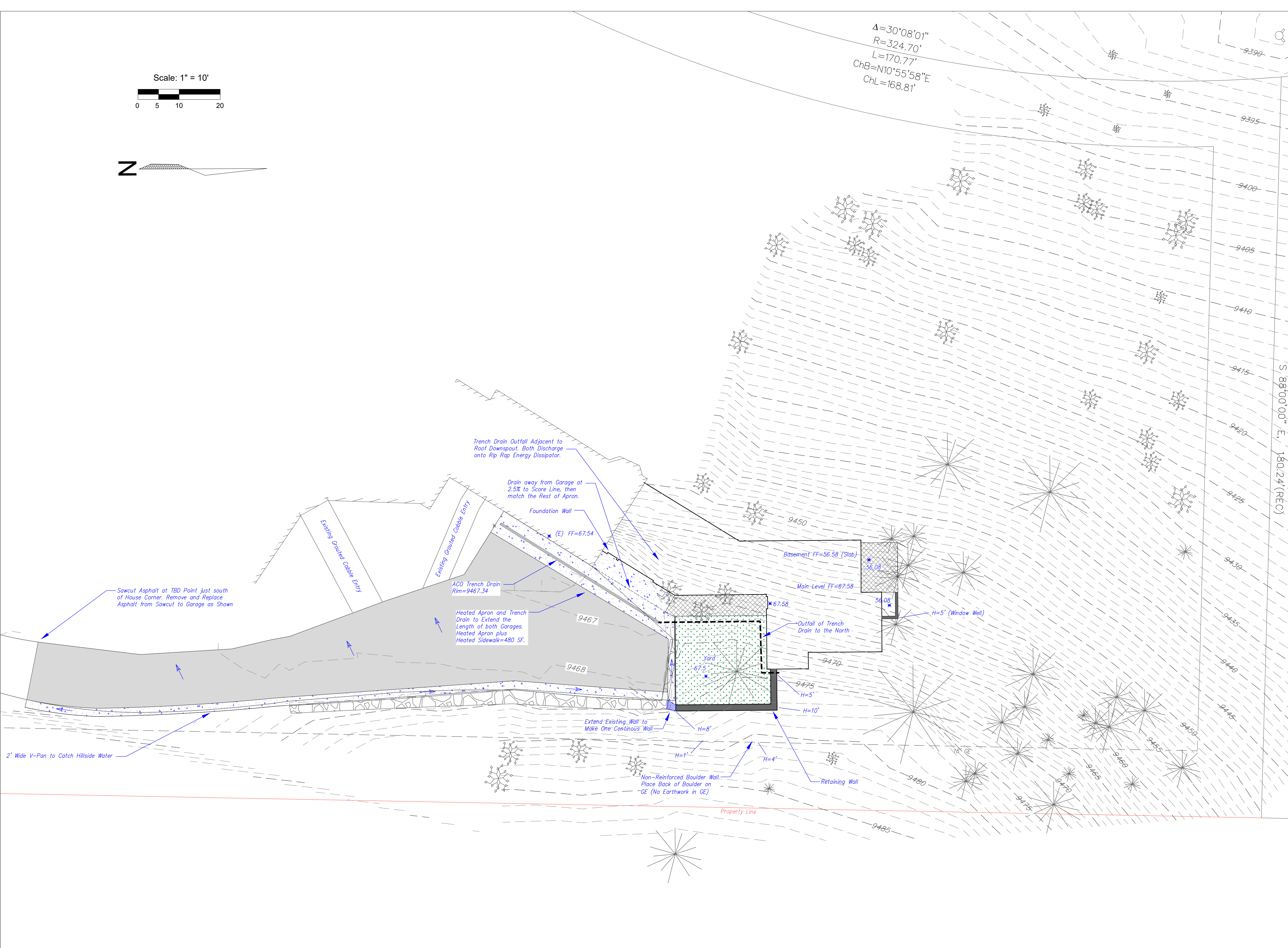



Exterior and Site Lighting Notes

1. All exterior lighting levels to be coordinated with TCMV Inspector or code enforcer to set and lock maximum illumination levels prior to issuance of Certificate of Occupancy.
2. All new exterior lighting to be tied into home control system to limit maximum levels, set exterior lighting scenes and automated off functions.
3. All exterior lighting will be eighty-five degrees (85°) full cut-off fixtures that direct the light downward without any off-site glare, except as exempted in Section 17.9.12(D).
4. All exterior light fixtures will be LED lighting or other equivalent high efficacy lighting. Any fixtures with a 0-5 watt lamp shall have a minimum overall luminous efficacy of 30 lumens/watt; any fixture with a 6-15 watt lamp shall have a minimum overall luminous efficacy of 45 lumens/watt.
5. Maximum Temperature. The maximum correlated color temperature for all proposed lighting types regardless of lamp type shall be a minimum of 2400K and shall not exceed 3000K, or may employ amber light sources, filtered LED light sources, or a suitable alternative - with the goal of having a warmer light source.
6. The maximum height for a wall-mounted light fixture shall be seven feet (7') above the directly adjacent walking surface or pathway, except for sign lighting that may be higher as reviewed and approved by the review authority to allow for proper illumination of the sign.
7. Exterior lighting on second or higher stories shall be provided by wall-mounted fixtures, recessed wall or ceiling fixtures, or lighting that is lowered or otherwise designed to prevent off-site glare.
8. Exterior Lighting on second and upper floors will be on either a timer or sensor to reduce usage and energy loss during times of inactivity.
9. Levels of Illumination: Exterior Lighting, when in use, shall meet the following standards for illumination of light, consistent with the provisions listed below. A point-to-point photometric calculation listing the number, type, height, and level of illumination of all exterior lighting fixtures may be required as per Section 17.9.12(E)(4) prior to Design Review Board approval or staff approval to ensure compliance with these provisions.
 - a. Parking lots, driveways, trash enclosures/areas, and group mailboxes shall be illuminated with a maximum average not to exceed four (4 fc) foot-candles of light.
 - b. Pedestrian walkways and staircases shall be illuminated with a maximum average not to exceed two (2 fc) foot-candles of light or as otherwise required by building code.
 - c. Exterior doors shall be illuminated with a minimum maintained one (1 fc) foot-candle of light, measured within a five (5' 0") foot radius on each side of the door at ground level or as otherwise required by building code.
 - d. In order to minimize light trespass on abutting residential property, illumination measured at the nearest residential structure or rear yard setback line shall not exceed the moon's potential ambient illumination of one-tenth (0.1 fc) foot-candle.
 - e. The use of exterior lighting shall be minimized in areas of important wildlife habitat and delineated wetlands, and lighting shall be designed so that it does not spill over or onto such critical habitat.

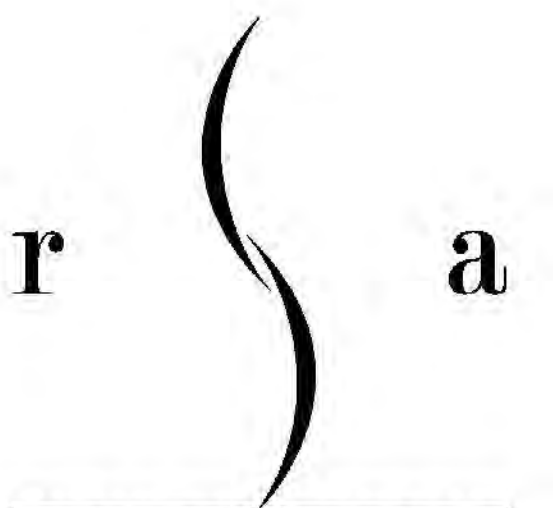
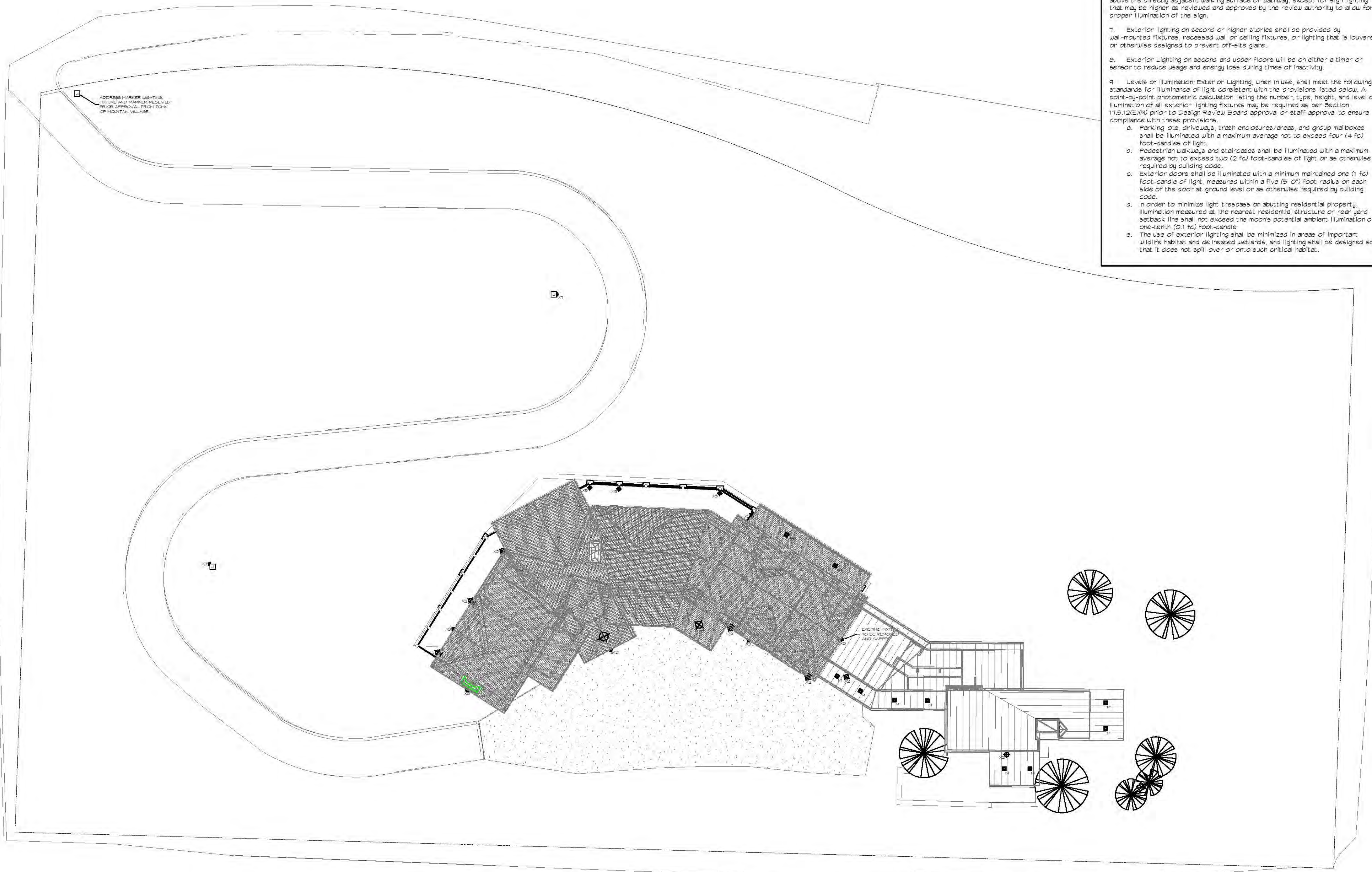

ROBERT SINGER & ASSOCIATES INC.
 DESIGN CONSULTANTS
 LIGHTING SPECIALISTS
 Corporate Member
 IALD, IES
 655 E. Valley Rd. Suite 200
 Basalt, CO 81621
 6842 E. Hummingbird Ln.
 Paradise Valley, AZ 85253
 T 970.983.5692
 www.rsa-light.com

© 2020 ROBERT SINGER & ASSOCIATES INC. NOTE: ALL DESIGN IDEAS AND CONCEPTS DEVELOPED IN THIS DRAWING SHALL REMAIN THE SOLE PROPERTY OF ROBERT SINGER & ASSOCIATES INC. ALL DRAWINGS ARE BASED ON INFORMATION SUPPLIED TO R.S.A. BY THE ARCHITECT/DESIGNER. ALL SITE SPECIFIC CONDITIONS AND DIMENSIONS TO BE CONTRACTOR VERIFIED. CONTRACTOR ASSUMPTION OF ALL RESPONSIBILITY IS HERE BY REFERRED TO ANY INTERPRETATION OF DRAWINGS TO BE CONFIRMED BY DESIGNER. ALL WORK MUST BE IN COMPLETE ACCORDANCE WITH ALL CODES, REGULATIONS, AND REQUIREMENTS OF ALL GOVERNING AUTHORITIES HAVING JURISDICTION OVER THIS WORK INCLUDING LOCAL UTILITIES. AND IN ACCORDANCE WITH THE UNDERWRITERS REQUIREMENTS. THE ABOVE DRAWINGS, SPECIFICATIONS, SCHEDULES, DETAILS, AND ARRANGEMENTS REPRESENTED THEREIN ARE AND SHALL REMAIN THE PROPERTY OF THE DESIGNER AND NO PART THEREOF SHALL BE COPIED, DISCLOSED TO OTHERS, OR USED IN CONNECTION WITH ANY WORK OR PROJECT OTHER THAN THE SPECIFIED PROJECT FOR WHICH THEY HAVE BEEN PREPARED AND DELIVERED WITHOUT THE WRITTEN CONSENT OF THE DESIGNER. VISUAL CONTACT WITH THESE PLANS OR SPECIFICATIONS SHALL CONSTITUTE CONCLUSIVE EVIDENCE OF ACCEPTANCE OF THESE RESTRICTIONS.



Issue:

09.23.2020	DRB REVIEW
03.30.2020	DRB CLARIFICATION

PROJECT
MOUNTAIN YACHT
 121 TOUCHDOWN
 MOUNTAIN VILLAGE, CO
 DESCRIPTION
 SITE LIGHTING PLAN
 SCALE: 1/16"=1'-0"
 SHEET

LT1.0

1 SITE LIGHTING PLAN - 50% LIGHT LEVELS
 LT1.0 SCALE: 1/16"=1'-0"



Exterior and Site Lighting Notes

- All exterior lighting levels to be coordinated with TCMV Inspector or code enforcer to set and lock maximum illumination levels prior to issuance of Certificate of Occupancy.
- All new exterior lighting to be tied into home control system to limit maximum levels, set exterior lighting scenes and automated off functions.
- All exterior lighting will be eighty-five degrees (85°) full cut-off fixtures that direct the light downward without any off-site glare, except as exempted in Section 17.9.12(D).
- All exterior light fixtures will be LED lighting or other equivalent high efficacy lighting. Any fixtures with a 0-5 watt lamp shall have a minimum overall luminous efficacy of 30 lumens/watt; any fixture with a 6-15 watt lamp shall have a minimum overall luminous efficacy of 45 lumens/watt.
- Maximum Temperature. The maximum correlated color temperature for all proposed lighting types regardless of lamp type shall be a minimum of 2400K and shall not exceed 3000K, or may employ amber light sources, filtered LED light sources, or a suitable alternative - with the goal of having a warmer light source.
- The maximum height for a wall-mounted light fixture shall be seven feet (7') above the directly adjacent walking surface or pathway, except for sign lighting that may be higher as reviewed and approved by the review authority to allow for proper illumination of the sign.
- Exterior lighting on second or higher stories shall be provided by wall-mounted fixtures, recessed wall or ceiling fixtures, or lighting that is lowered or otherwise designed to prevent off-site glare.
- Exterior Lighting on second and upper floors will be on either a timer or sensor to reduce usage and energy loss during times of inactivity.
- Levels of Illumination: Exterior Lighting, when in use, shall meet the following standards for illuminance of light, consistent with the provisions listed below. A point-by-point photometric calculation listing the number, type, height, and level of illumination of all exterior lighting fixtures may be required as per Section 17.9.12(E)(4) prior to Design Review Board approval or staff approval to ensure compliance with these provisions.
 - Parking lots, driveways, trash enclosures/areas, and group mailboxes shall be illuminated with a maximum average not to exceed four (4 fc) foot-candles of light.
 - Pedestrian walkways and staircases shall be illuminated with a maximum average not to exceed two (2 fc) foot-candles of light or as otherwise required by building code.
 - Exterior doors shall be illuminated with a minimum maintained one (1 fc) foot-candle of light, measured within a five (5' 0") foot radius on each side of the door at ground level or as otherwise required by building code.
 - In order to minimize light trespass on abutting residential property, illumination measured at the nearest residential structure or rear yard setback line shall not exceed the moon's potential ambient illumination of one-tenth (0.1 fc) foot-candle.
 - The use of exterior lighting shall be minimized in areas of important wildlife habitat and delineated wetlands, and lighting shall be designed so that it does not spill over or onto such critical habitat.

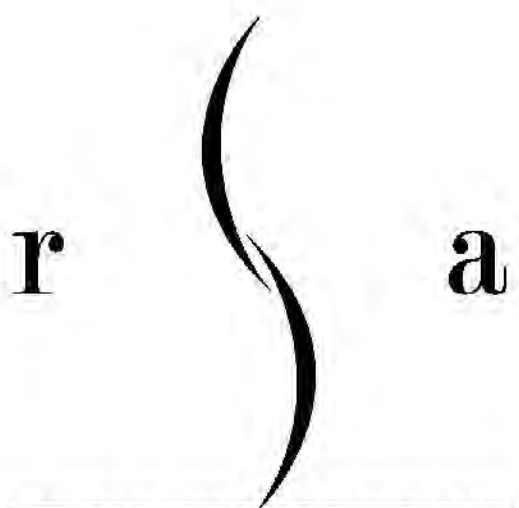
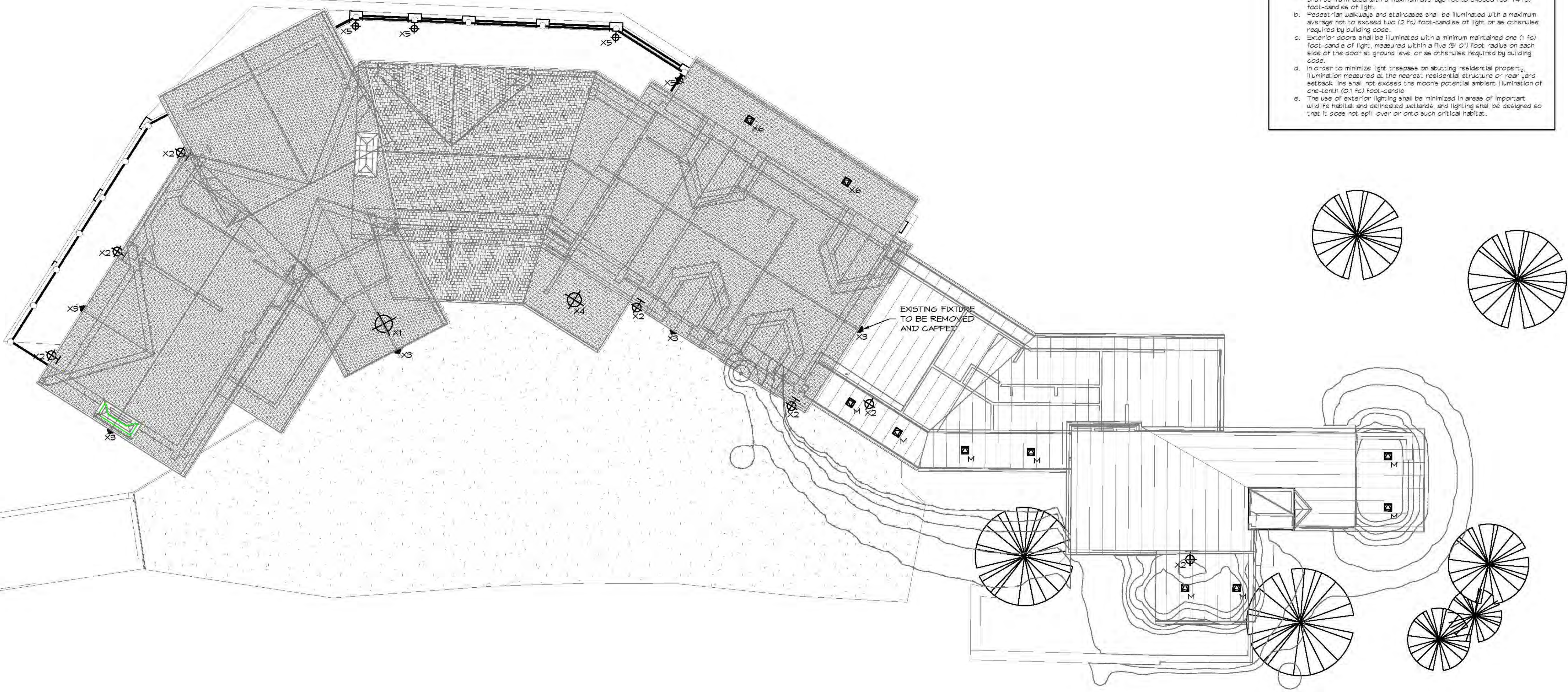

ROBERT SINGER & ASSOCIATES INC.

DESIGN CONSULTANTS
LIGHTING SPECIALISTS
Corporate Member
IALD, IES

655 E. Valley Rd. Suite 200
Basalt, CO 81621

6842 E. Hummingbird Ln.
Paradise Valley, AZ 85253

T 970.983.5692
www.rsa-light.com

© 2020 ROBERT SINGER & ASSOCIATES INC. NOTE: ALL DESIGN IDEAS AND CONCEPTS DEVELOPED IN THIS DRAWING SHALL REMAIN AT ALL TIMES THE SOLE PROPERTY OF ROBERT SINGER & ASSOCIATES INC. ALL DRAWINGS ARE BASED ON INFORMATION SUPPLIED TO R.S.A. BY THE ARCHITECT/DESIGNER. ALL SITE SPECIFIC CONDITIONS AND DIMENSIONS TO BE CONTRACTOR VERIFIED. CONTRACTOR ASSUMPTION OF ALL RESPONSIBILITY IS HEREBY REFERRED AND ANY INTERPRETATION OF DRAWINGS IS TO BE CONFIRMED BY DESIGNER. ALL WORK MUST BE IN COMPLETE ACCORDANCE WITH ALL CODES, REGULATIONS, AND REQUIREMENTS OF ALL GOVERNING AUTHORITIES HAVING JURISDICTION OVER THIS WORK INCLUDING LOCAL UTILITIES. AND IN ACCORDANCE WITH THE UNDERWRITTEN REQUIREMENTS. THE ABOVE DRAWINGS, SPECIFICATIONS, IDEAS, DESIGN, AND ARRANGEMENTS REPRESENTED THEREBY ARE AND SHALL REMAIN THE PROPERTY OF THE DESIGNER AND NO PART THEREOF SHALL BE COPIED, DISCLOSED TO OTHERS, OR USED IN CONNECTION WITH ANY WORK OR PROJECT OTHER THAN THE SPECIFIED PROJECT FOR WHICH THEY HAVE BEEN PREPARED AND DELIVERED WITHOUT THE WRITTEN CONSENT OF THE DESIGNER. VISUAL CONTACT WITH THESE PLANS OR SPECIFICATIONS SHALL CONSTITUTE CONCLUSIVE EVIDENCE OF ACCEPTANCE OF THESE RESTRICTIONS.



Issue:
09.23.2020
DRB REVIEW

03.30.2020
DRB CLARIFICATION

PROJECT
MOUNTAIN YACHT

121 TOUCHDOWN
MOUNTAIN VILLAGE, CO
DESCRIPTION
EXTERIOR LIGHTING
PLAN

SCALE: 1/8"=1'-0"
SHEET

LT1.1

1 EXTERIOR LIGHTING PLAN - 50% LIGHT LEVELS
LT1.1 SCALE: 1/8"=1'-0"



Exterior and Site Lighting Notes

1. All exterior lighting levels to be coordinated with TCMV inspector or code enforcer to set and lock maximum illumination levels prior to issuance of Certificate of Occupancy.
2. All new exterior lighting to be tied into home control system to limit maximum levels, set exterior lighting scenes and automated off functions.
3. All exterior lighting will be eighty-five degrees (85°) full cut-off fixtures that direct the light downward without any off-site glare, except as exempted in Section 17.9.12(D).
4. All exterior light fixtures will be LED lighting or other equivalent high efficacy lighting. Any fixture with a 0-35 watt lamp shall have a minimum overall luminous efficacy of 30 lumens/watt; any fixture with a 6-15 watt lamp shall have a minimum overall luminous efficacy of 45 lumens/watt.
5. Maximum Temperature. The maximum correlated color temperature for all proposed lighting types regardless of lamp type, shall be a minimum of 2,400K and shall not exceed 3,000K, or may employ amber light sources, filtered LED light sources, or a suitable alternative - with the goal of having a warmer light source.
6. The maximum height for a wall-mounted light fixture shall be seven feet (7') above the directly adjacent walking surface or pathway, except for sign lighting that may be higher as reviewed and approved by the review authority to allow for proper illumination of the sign.
7. Exterior lighting on second or higher stories shall be provided by wall-mounted fixtures, recessed wall or ceiling fixtures, or lighting that is lowered or otherwise designed to prevent off-site glare.
8. Exterior Lighting on second and upper floors will be on either a timer or sensor to reduce usage and energy loss during times of inactivity.
9. Levels of Illumination: Exterior Lighting, when in use, shall meet the following standards for illumination of light consistent with the provisions listed below. A point-by-point photometric calculation listing the number, type, height, and level of illumination of all exterior lighting fixtures may be required as per Section 17.9.12(E)(4) prior to Design Review Board approval or staff approval to ensure compliance with these provisions.
 - a. Parking lots, driveways, trash enclosures/areas, and group mailboxes shall be illuminated with a maximum average not to exceed four (4 fc) foot-candles of light.
 - b. Pedestrian walkways and staircases shall be illuminated with a maximum average not to exceed two (2 fc) foot-candles of light or as otherwise required by building code.
 - c. Exterior doors shall be illuminated with a minimum maintained one (1 fc) foot-candle of light, measured within a five (5' 0") foot radius on each side of the door at ground level or as otherwise required by building code.
 - d. In order to minimize light trespass on abutting residential property, illumination measured at the nearest residential structure or rear yard setback line shall not exceed the moon's potential ambient illumination of one-tenth (0.1 fc) foot-candle.
 - e. The use of exterior lighting shall be minimized in areas of important wildlife habitat and designated wetlands, and lighting shall be designed so that it does not spill over or onto such critical habitat.

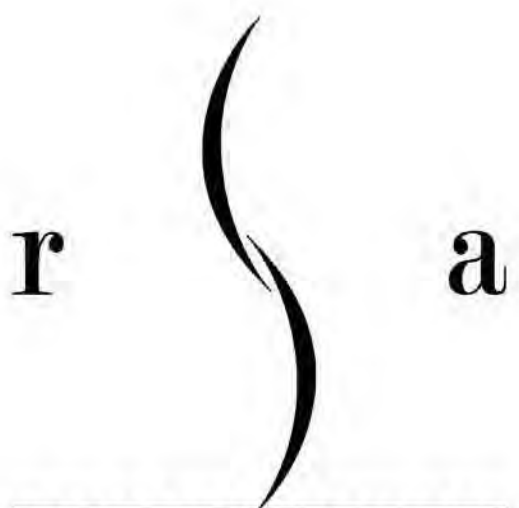
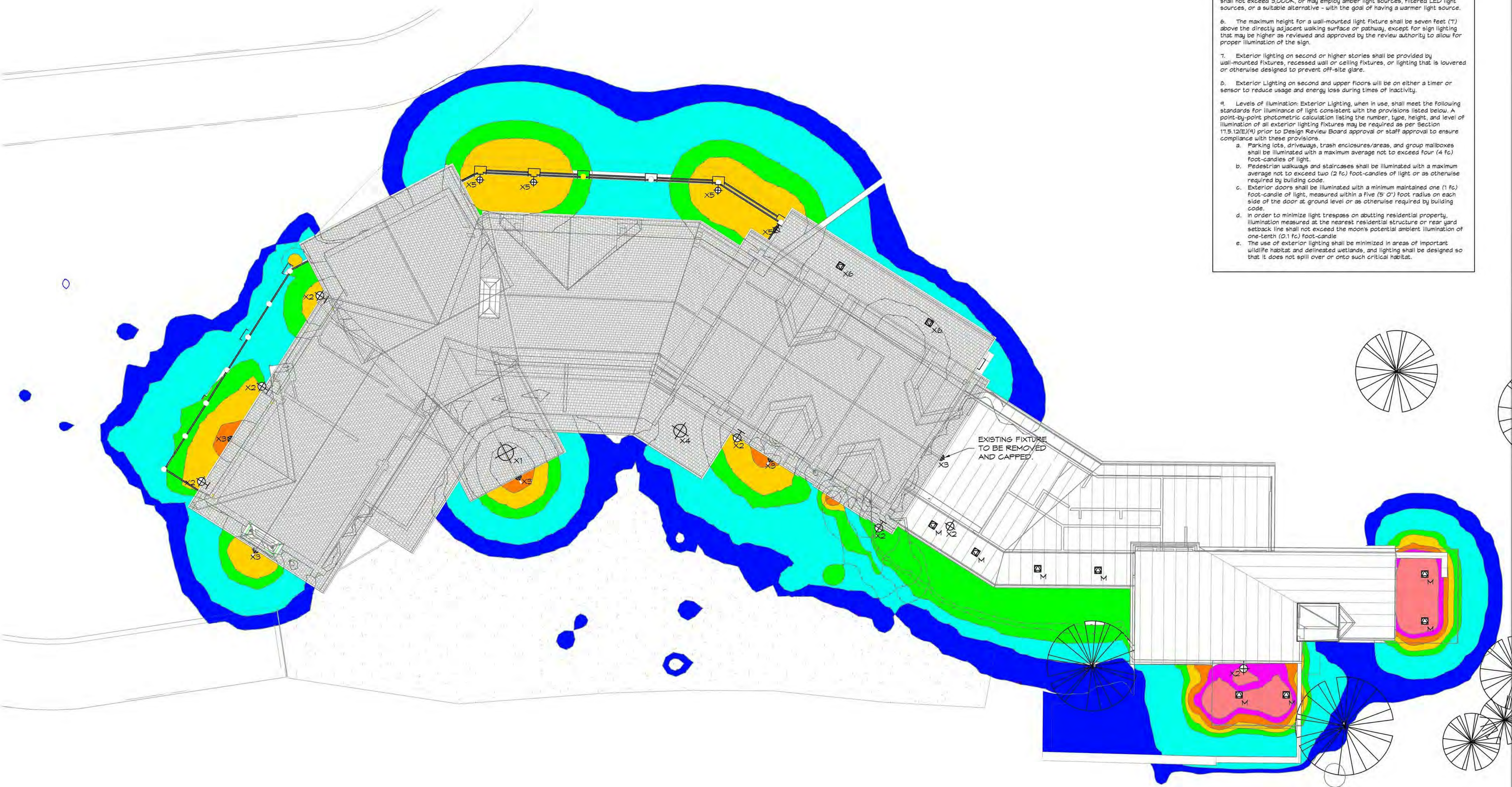

ROBERT SINGER & ASSOCIATES INC.
 DESIGN CONSULTANTS
 LIGHTING SPECIALISTS
 Corporate Member
 IALD, IES
 655 E. Valley Rd. Suite 200
 Basalt, CO 81621
 6842 E. Hummingbird Ln.
 Paradise Valley, AZ 85253
 T 970.963.5692
 www.rsa-light.com

© 2020 ROBERT SINGER & ASSOCIATES INC. NOTE: ALL DESIGN IDEAS AND CONCEPTS DEVELOPED IN THIS DRAWING SHALL REMAIN AT ALL TIMES THE SOLE PROPERTY OF ROBERT SINGER & ASSOCIATES INC. ALL DRAWINGS ARE BASED ON INFORMATION SUPPLIED TO R.S.A. BY THE ARCHITECT/DESIGNER. ALL SITE SPECIFIC CONDITIONS AND DIMENSIONS TO BE CONTRACTOR VERIFIED. CONTRACTOR ASSUMPTION OF ALL RESPONSIBILITY IS HEREBY REFERRED AND ANY INTERPRETATION OF DRAWINGS IS TO BE CONFIRMED BY DESIGNER. ALL WORK MUST BE IN COMPLETE ACCORDANCE WITH ALL CODES, REGULATIONS, AND REQUIREMENTS OF ALL GOVERNING AUTHORITIES HAVING JURISDICTION OVER THE WORK INCLUDING LOCAL UTILITIES, AND IN ACCORDANCE WITH THE UNDERSIGNED'S REQUIREMENTS THE ABOVE DRAWINGS, SPECIFICATIONS, IDEAS, DESIGN AND ARRANGEMENTS REPRESENTED THEREBY ARE AND SHALL REMAIN THE PROPERTY OF THE DESIGNER AND NO PART THEREOF SHALL BE COPIED, DISCLOSED TO OTHERS, OR USED IN CONNECTION WITH ANY WORK OR PROJECT OTHER THAN THE SPECIFIED PROJECT FOR WHICH THEY HAVE BEEN PREPARED AND DEVELOPED WITHOUT THE WRITTEN CONSENT OF THE DESIGNER. VISUAL CONTACT WITH THESE PLANS OR SPECIFICATIONS SHALL CONSTITUTE CONCLUSIVE EVIDENCE OF ACCEPTANCE OF THESE RESTRICTIONS.



Issue:
 09.23.2020
 DRB REVIEW

03.30.2020
 DRB CLARIFICATION

PROJECT
MOUNTAIN YACHT
 121 TOUCHDOWN
 MOUNTAIN VILLAGE, CO
 DESCRIPTION

SITE LIGHTING PLAN
 SCALE: 1/16"=1'-0"
 SHEET

LT1.01

1 SITE LIGHTING PLAN - 50% LIGHT LEVELS
 LT1.01 SCALE: 1/16"=1'-0"



CURRENT ADDRESS MARKER



CURRENT PENDANT, FIXTURE 'X1'



CURRENT SCONCE, FIXTURE 'X2'



CURRENT PERIMETER, FIXTURE 'X3'



CURRENT SURFACE, FIXTURE 'X4'



CURRENT LOWER PATIO, FIXTURE 'X5'



CURRENT DRIVEWAY, FIXTURE 'X7'

RSA SUGGESTS THE REPLACEMENT OF ALL EXISTING FIXTURES IN ORDER TO COMPLY WITH CURRENT TOWN OF MOUNTAIN VILLAGE REGULATIONS. ALTERNATES TO THE FIXTURES CHOSEN SHALL BE IN COMPLIANCE WITH TOMV REGULATIONS. ALTERNATIVELY FROSTING THE INSIDE OF EXISTING DECORATIVE FIXTURES WILL BRING FIXTURES INTO COMPLIANCE WITH CURRENT REGULATIONS.

OWNERS HAVE REPLACED THE ADDRESS MARKER WITH A NEW MONUMENT. RATHER THAN REPLACE EXISTING LANTERNS TYPE 'X7' THE OWNERS MAY CHOOSE TO INSTALL STONE MONUMENTS TO MATCH EXISTING ADDRESS MARKER WITH STEPLIGHT AT DRIVEWAY FACE OR POST TOP. FIXTURE CHOSEN SHALL BE IN COMPLIANCE WITH TOMV REGULATIONS.

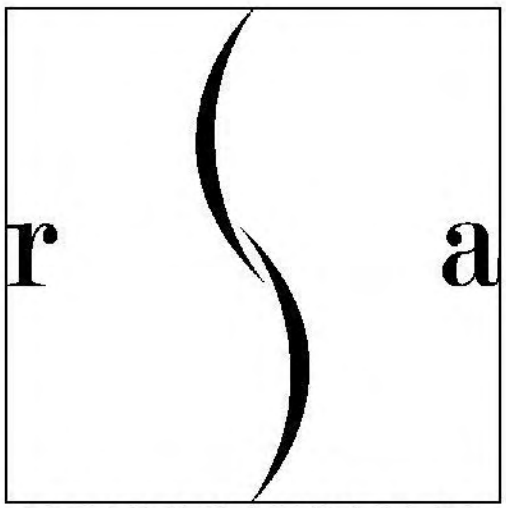

ROBERT SINGER & ASSOCIATES INC.

DESIGN CONSULTANTS
LIGHTING SPECIALISTS
Corporate Member
IALD, IES

655 E. Valley Rd. Suite 200
Basalt, CO 81621

6842 E. Hummingbird Ln.
Paradise Valley, AZ 85253

T 970.963.5692
www.rsa-light.com

© 2020 ROBERT SINGER & ASSOCIATES INC. NOTE: ALL DESIGNS, IDEAS, AND CONCEPTS DEVELOPED IN THIS DRAWING SHALL REMAIN THE SOLE PROPERTY OF ROBERT SINGER & ASSOCIATES INC. ALL DRAWINGS ARE BASED ON INFORMATION SUPPLIED TO R.S.A. BY THE ARCHITECT/DESIGNER. ALL SITE SPECIFIC CONDITIONS AND DIMENSIONS TO BE CONTRACTOR VERIFIED. CONTRACTOR ASSUMPTION OF ALL RESPONSIBILITY IS HERE INFERRED AND ACCEPTED BY ALL. CONTRACTOR SHALL BE IN COMPLETE ACCORDANCE WITH ALL CODES, REGULATIONS, AND REQUIREMENTS OF ALL GOVERNING AUTHORITIES HAVING JURISDICTION OVER THIS WORK INCLUDING LOCAL, STATE, AND FEDERAL. DESIGN AND ARRANGEMENTS REPRESENTED THEREIN ARE AND SHALL REMAIN THE PROPERTY OF THE DESIGNER AND NO PART THEREOF SHALL BE COPIED, REPRODUCED, OR USED IN CONNECTION WITH ANY WORK OR PROJECT OTHER THAN THE SPECIFIC PROJECT FOR WHICH THEY HAVE BEEN PREPARED AND DEVELOPED WITHOUT THE WRITTEN CONSENT OF THE DESIGNER. VISUAL CONTACT WITH THESE PLANS OR SPECIFICATIONS SHALL CONSTITUTE CONCLUSIVE EVIDENCE OF ACCEPTANCE OF THESE RESTRICTIONS.

Issue:

09.23.2020
DRB REVIEW



PROJECT

MOUNTAIN YACHT

121 TOUCHDOWN
MOUNTAIN VILLAGE, CO

DESCRIPTION
EXISTING LIGHTING
IMAGES

SCALE: NOT TO SCALE
SHEET

LT5.3

Lot 424 - 121 Touchdown
DRB Review: 9/23/2020



Type	Image	Product / Manufacturer	Attributes	Notes
Architectural Lighting				
M		HK Lighting Group "Surface Mount LED" Description: Wet Location LED Monopoint	Catalog #: ZXL11-SQ-GSA-12V-7-30-42-DK-SOL; CB4.0-SQ; LEDDRV-H-60 Lamping: 7W; 3000K; 80CRI; 560 Lumens Dimming Type: ELV Dimming Voltage: 12V with Canopy Mount Transformer	Length: 6.06" Width: 2.46" Height: 9.25"
X3		HK Lighting Group "Wall Mount LED" Description: SUGGESTED REPLACEMENT - Wet Location LED Monopoint	Catalog #: ZXL20i-WM-SQ-GSA-UNV-X18-30-26-PH-BK-SOL; CB5.1 Lamping: 18W; 3000K; 83CRI; 1390 Lumens Dimming Type: Phase Dimming Voltage: Universal	Length: 6.06" Width: 2.46" Height: 9.25"
X7		TBD LED Solutions "Step Light" Description: MONUMENT OPTION - Horizontal Recessed LED Steplight	Catalog #: TBD.STS5.3-30K-***-**; QOM-***DC-CAP-120/12-***+CK-S Lamping: 2W; 185 Lumen; 90+ CRI; 3000K LED Voltage: 12V DC/120V Dimming Type: LED Forward Phase Driver: Line Voltage or Remote Power Supply	Length: 1.76" Width: 5.22" Height: 3.28" Location for remote power supply by EC.
Decorative Lighting				
X1		Troy Lighting "Exterior Pendant" Description: SUGGESTED REPLACEMENT - Wet Location LED Pendant	Catalog #: Bennington F1358FBZ; LEDBA11 Lamping: (3)5.5W; 3000K; 90CRI; 500 Lumen Location: Main Entry Quantity: 1	Width: 13.5" Sq Height: 15.25"
X2		Modern Forms "Exterior Sconce" Description: SUGGESTED REPLACEMENT - Wet Location LED Sconce	Catalog #: WS-W28521-ORB Lamping: 15W; 3000K; 90CRI; 1200 Lumens Location: Perimeter Sconce Quantity: 7	Width: 9" Height: 21" Proj: 10-1/4"

RSA

970-963-5692 www.rsa-light.com

Type	Image	Product / Manufacturer	Attributes	Notes
X4		HK Lighting Group "Surface Mount LED" Description: SUGGESTED REPLACEMENT - Wet Location LED Monopoint	Catalog #: ZXL11-SQ-GSA-12V-7-30-42-DK-SOL; CB4.0-SQ; LEDDRV-H-60 Lamping: 7W; 3000K; 80CRI; 560 Lumens Dimming Type: ELV Dimming Voltage: 12V with Canopy Mount Transformer	Length: 6.06" Width: 2.46" Height: 9.25"
X5		WAC Lighting "Exterior Sconce" Description: SUGGESTED REPLACEMENT - Wet Location LED Sconce	Catalog #: WS-W24509-AB-10W-744-400 Lamping: 10W; 3000K; 90CRI; 744 Lumens Location: Lower Patio Sconce Quantity: 4	Width: 6" Height: 9-1/2" Proj: 7-1/8"

RSA

970-963-5692 www.rsa-light.com

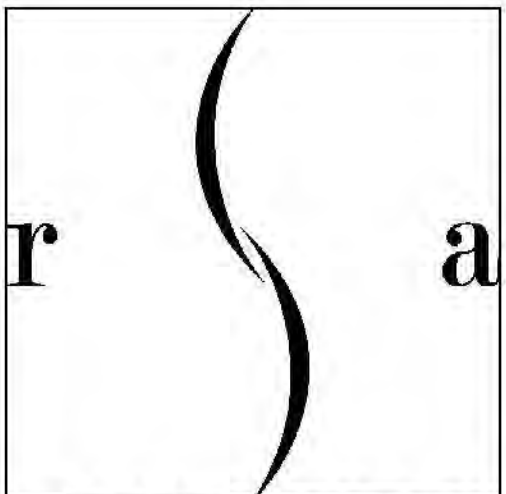

ROBERT SINGER & ASSOCIATES INC.

DESIGN CONSULTANTS
 LIGHTING SPECIALISTS
 Corporate Member
 IALD, IES

655 E. Valley Rd. Suite 200
 Basalt, CO 81621

6842 E. Hummingbird Ln.
 Paradise Valley, AZ 85253

T 970.963.5692
 www.rsa-light.com

© 2009 ROBERT SINGER & ASSOCIATES INC. NOTE: ALL DESIGNS, IDEAS, AND CONCEPTS DEVELOPED IN THE DRAWING SHALL REMAIN AT ALL TIMES THE SOLE PROPERTY OF ROBERT SINGER & ASSOCIATES INC. ALL DRAWINGS ARE BASED ON INFORMATION SUPPLIED TO U.S.A. BY THE ARCHITECT/DESIGNER. ALL SITE SPECIFIC CONDITIONS AND DIMENSIONS TO BE CONTRACTOR VERIFIED. CONTRACTOR ASSUMPTION OF ALL RESPONSIBILITY IS HEREBY INFERRED AND ANY INTERPRETATION OF DRAWINGS IS TO BE CONFIRMED BY DESIGNER. ALL WORK MUST BE IN COMPLETE ACCORDANCE WITH ALL GOVERNING REGULATIONS, AND REQUIREMENTS OF ALL GOVERNING AUTHORITIES HAVING JURISDICTION OVER THIS WORK. REGULATIONS, AND REQUIREMENTS WITHIN THESE DRAWINGS SPECIFICATIONS, AND IN ACCORDANCE WITH FIRE UNDERWRITERS REQUIREMENTS. THESE DRAWINGS SPECIFICATIONS, IDEAS, DESIGNS, AND ARRANGEMENTS REPRESENTED THEREIN ARE AND SHALL REMAIN THE PROPERTY OF THE DESIGNER AND NO PART THEREOF SHALL BE COPIED, DISCLOSED TO OTHERS, OR USED IN CONNECTION WITH ANY WORK OR PROJECT OTHER THAN THE SPECIFIC PROJECT FOR WHICH THEY HAVE BEEN PREPARED AND DEVELOPED WITHOUT THE WRITTEN CONSENT OF THE DESIGNER. VISUAL CONTACT WITH THESE PLANS OR SPECIFICATIONS SHALL CONSTITUTE CONCLUSIVE EVIDENCE OF ACCEPTANCE OF THESE RESTRICTIONS.

Issue:
 09.23.2020
 DRB REVIEW



PROJECT
MOUNTAIN YACHT
 121 TOUCHDOWN
 MOUNTAIN VILLAGE, CO
 DESCRIPTION

LIGHTING SCHEDULE
 SCALE: NOT TO SCALE
 SHEET

LT7.1



AGENDA ITEM 5
PLANNING & DEVELOPMENT SERVICE
PLANNING DIVISION
455 Mountain Village Blvd.
Mountain Village, CO 81435
(970) 728-1392

TO: Mountain Village Design Review Board
FROM: Amy Ward, Planner
FOR: Design Review Board Public Hearing; June 10, 2021
DATE: June 2, 2021
RE: Staff Memo – Initial Architecture and Site Review (IASR) Lot 214A, 209 Benchmark Drive

APPLICATION OVERVIEW: New Single-Family Home on Lot 214A

PROJECT GEOGRAPHY

Legal Description: LOT 214-A, TELLURIDE MOUNTAIN VILLAGE, FILING 6, ACCORDING TO THE PLAT RECORDED MARCH 24, 1987 IN PLAT BOOK 1 AT PAGE 708, COUNTY OF SAN MIGUEL, STATE OF COLORADO.

Address: 209 Benchmark Dr.

Applicant/Agent: Ron Bercovitz, Bercovitz Design

Owner: Benchmark 214 LLC

Zoning: Single-Family

Existing Use: Vacant

Proposed Use: Single-Family

Lot Size: .359 acres

Adjacent Land Uses:

- **North:** Single-family
- **South:** Single-family
- **East:** Single-family
- **West:** Single-family

ATTACHMENTS

Exhibit A: Architectural Plan Set

Exhibit B: Staff/Public Comment

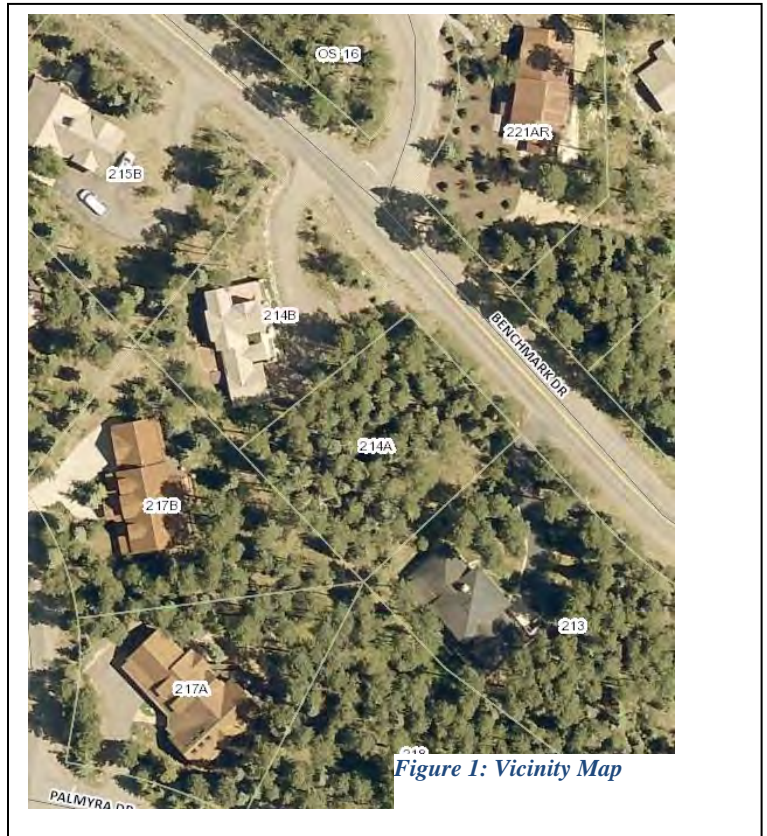

Figure 1: Vicinity Map

Case Summary: Ron Bercovitz of Bercovitz Design, Applicant for Lot 214A, is requesting Design Review Board (DRB) approval of an Initial Architectural and Site Review (IASR) Application for a new single-family home on Lot 214A, 209 Benchmark Drive. The Lot is approximately .359 acres and is zoned Single-family. The overall square footage of the home is approximately 4,900 gross square feet and provides 2 interior parking spaces within the proposed garage.

Applicable CDC Requirement Analysis: The applicable requirements cited may not be exhaustive or all-inclusive. The applicant is required to follow all requirements even if an applicable section of the CDC is not cited. **Please note that Staff comments will be indicated by *Italicized Text*.**

Table 1

<u>CDC Provision</u>	<u>Requirement</u>	<u>Proposed</u>
Maximum Building Height	35' (shed) Maximum	27.1'
Maximum Avg. Building Height	30' (shed) Maximum	15.58'
Maximum Lot Coverage	40% (6,255 s.f.)	29.1% (4,566 s.f.)
General Easement Setbacks	No encroachment	Grading, hammerhead, and hardscape
Roof Pitch		
Primary		1.5:12
Secondary		1.5:12
Exterior Material		
Stone	35% minimum	32.52%
Windows/Doors	40% maximum	32.7%
Parking	2 interior/2 exterior	2/2

Design variations:

- 1) Exterior Wall Materials – less than 35% stone
- 2) Exterior Wall Materials – Hardie Trim fascia
- 3) Tandem Parking

DRB Specific Approval:

- 1) GE encroachment – Grading, hammerhead, and hardscaping

Chapter 17.3: ZONING AND LAND USE REGULATIONS

17.3.12: Building Height Limits

Sections 17.3.11 and 17.3.12 of the CDC provide the methods for measuring Building Height and Average Building Height, along with providing the height allowances for specific types of buildings based on their architectural form. The proposed design incorporates a combination of shed roof forms. Homes with a primary shed roof form are granted a maximum building height of 35 feet. The maximum average height must be at or below 30 feet for homes with a primary shed roof form. The average height is an average of measurements from a point halfway between the roof ridge and eave. The points are generally every 20 feet around the roof. The maximum height is measured from the highest point on a roof directly down to the existing grade or finished grade, whichever is more restrictive.

Staff: Staff has determined that the primary roof form for this home is a shed and therefore granted a maximum height of 35 feet. The applicant has given a max height of 27.1' and a max average height of 15.58' which appear to meet the requirements for both Maximum

and Maximum Average heights and has provided a parallel plane analysis that also demonstrates such compliance.

17.3.14: General Easement Setbacks

Lot 214A is burdened by a sixteen (16) foot General Easement (GE) which surrounds its perimeter. The CDC provides that the GE and other setbacks be maintained in a natural, undisturbed state to provide buffering to surrounding land uses. The CDC does provide for some development activity within the GE and setbacks such as Ski Access, Natural Landscaping, Utilities, Address Monuments, and Fire Mitigation. All encroachments not listed above will require encroachment agreements between the property owner and the Town.

Staff: The proposal includes several GE encroachments that fall into the above category of permitted GE development activity including the following:

- *Driveway: The Driveway as shown currently takes access from Benchmark Drive and crosses the General Easement to the homesite.*
- *Utilities: Given Lot 214A's location and the location of the existing utilities, the GE will need to be crossed on the North GE, accessing utilities within Benchmark Drive.*
- *Landscaping: There is some proposed new planting in the GE in the north, east, and West GE. The address monument is on the NW side of the drive in the GE as well. A General Encroachment Agreement should be created to capture both the landscaping and the monument.*

The proposal also includes some GE encroachments requiring specific DRB approval:

- *There is a stone patio, a small retaining wall, and some grading in the western GE.*
- *There is a hammerhead for the drive with an associated retaining wall and grading in the eastern GE.*

Staff: Public Works has some concern about encroachments in the Eastern GE, they would like all new plantings removed from the landscape plan in this GE for maintenance of a sewer line. They feel comfortable allowing for the hammerhead as long as the property owners are willing to enter into an encroachment agreement with the town.

Chapter 17.5: DESIGN REGULATIONS

17.5.4: Town Design Theme

The Town of Mountain Village has established design themes aimed at creating a strong image and sense of place for the community. Due to the fragile high alpine environment, architecture and landscaping shall be respectful and responsive to the tradition of alpine design – reflecting elements of alpine regions while blending influences that visually tie the town to mountain buildings. The town recognizes that architecture will continue to evolve and create a regionally unique mountain vernacular, but these evolutions must continue to embrace nature and traditional style in a way that respects the design context of the neighborhoods surrounding the site.

Staff: The home presents as a contemporary form, however the materials chosen will help to transition the home closer to some of the older, more traditional homes on Benchmark. Wood siding stained a warm brown and stone that looks like an earthy “telluride gold” will soften the contemporary lines of the home. A dark standing seam roof and black windows will contrast nicely. Some areas of corrugated, non-rusty steel siding also help to break up

the mass. All of these materials, which represent materials often used in mountain design will help to tie the design to its high alpine environment. Overall, it appears that the design is visually appealing and would fit within the existing Mountain Village Design Theme.

17.5.5: Building Siting Design

The CDC requires that any proposed development blend into the existing landforms and vegetation.

Staff: Lot 241A is quite small at approximately 0.3 acres and is extensively treed. Given the limited siting options, the house has been limited in overall options for size and location. When viewed in section, you can clearly see that much of this home is sub-grade and not visible from the road. The applicant has done a good job of settling the home into the hillside, and the stepped shed roofs provide light and views from different areas of the home. Staff feels it will blend into the sloped, treed site nicely.

17.5.6: Building Design

The CDC requires that building form and exterior wall forms portray a mass that is thick and strong with a heavy grounded foundation.

Staff: The home incorporates a shed roof form which allows for a projection of the form of the home upwards even with its grounded low heights. The way the house is sited to settle into the hillside and the extensive stonework at the base give it a subdued feeling that does not often come across with larger shed roof forms that present a large building mass. The fact that most of the exterior living space is a stone patio located at grade, with the exception of a small elevated deck at the front of the home also maintains that sense of a heavy grounded foundation.

More detail should be provided in terms of the wood siding, to better understand the installation, whether it will be installed in a shiplap, with a reveal, etc. as well as the corner detailing.

There are two proposed materials that merit some discussion. The fascia is proposed as a Hardie Trim. This material would require a design variation. Staff would like some more clarity from the applicant about why this material was chosen. In general, you would choose this material for its wildfire home hardening qualities, but since the home has both wood siding and wood soffit, the home hardening isn't as effective. If the DRB is comfortable with the applicant's reasoning for its application, then they should grant a design variation for the material, otherwise the applicant should revise this material choice for final review.

Stone siding as proposed does not meet the minimum requirement at 32.52%. DRB should discuss whether they are comfortable with this percentage and if so should grant a design variation. If not, the applicant should revise the exterior materials to conform to the 35% minimum.

Metal is used as a siding material on the south side of the home and just in a few small areas on the other elevations. If the applicant were to replace these smaller areas with stone the structure would appear more grounded and the home would likely meet its 35% stone minimum.

Staff is not recommending approval of either of these design variations at this time.

17.5.7: Grading and Drainage Design

Staff: Lot 214A slopes fairly consistently from Benchmark up to the SW. Because of the large sub-grade square footage, there will be a large quantity of excavated materials that will need to be either removed from the site or stockpiled. This amount of material should be understood in order to better inform the construction mitigation plans. As discussed previously there is some proposed grading in the GE. The slope at the SW corner of the home is noted at 2:1. It will be important to understand the applicant's stormwater management plan, this will be discussed further below.

17.5.8: Parking Regulations

Staff: The applicant has shown two interior and two exterior parking spaces on their plan. The exterior spaces are shown in a tandem format. They have also shown a hammerhead on the drive. Staff feels that allowing tandem parking and keeping the hammerhead as a turn-around area allows for a safer transition from the drive onto Benchmark.

From the CDC:

For single family, the review authority may allow for tandem spaces as the two (2) surface spaces for smaller lots less than 0.75 acre where non-tandem parking is not feasible due to unique site conditions such as steep slopes, wetlands and unique shaped lots, and may waive the two (2) surface spaces for smaller lots when tandem parking is not feasible.

DRB members should decide whether these conditions are met, and if they are in favor of tandem parking then should grant a design variation.

17.5.9: Landscaping Regulations

The applicant has provided a landscaping plan, the Town Forrester has indicated that diversity of species for planting has not been met and that clarification is needed on what types of shrub are proposed. Per comments from public works, any new landscaping needs to be removed from the eastern GE. The applicant should provide an updated landscaping plan prior to final review.

17.5.11: Utilities

Staff: Existing utilities pedestals for electric, phone fiber are at the northeast corner of the lot. It is assumed that sewer, water and gas are in Benchmark, but were not located. Most of the connections appear to be on the north side of the home facing Benchmark. This seems to be a very visible location. Staff would encourage the applicant to verify utility connection points and explore a less visible area or screening for utility connections prior to final review.

17.5.12: Lighting Regulations

Staff: A preliminary lighting plan has been provided, which consists of one fixture type – a recessed light. The specification for the fixture does not give its' lumen output so staff is unsure if it meets the lighting requirements of the CDC. A photometric study was not provided. Specification sheets for the recessed fixture as well as the fixture proposed for the address monument as well as a photometric study should be provided prior to final review. It should be noted that the Lighting Plan is not required until final review.

17.5.13: Sign Regulations

Staff: The address marker is on the west side of the driveway. The location seems visible from Benchmark in both directions. It uses stone and steel materials to match the home.

The indicated dimensions and lighting do not meet the CDC design regulations. The applicant should revise the design prior to final review.

Chapter 17.6: SUPPLEMENTARY REGULATIONS

17.6.1: Environmental Regulations

Staff: Fire Mitigation and Forestry Management: The applicant has submitted a fire mitigation plan that meets the Forestry provisions of the CDC.

17.6.6: Roads and Driveway Standards

Staff: The driveway appears to meet the width of 12' plus 2' shoulders, though this dimension should be called out on the plan. Both the entrance to the garage as well as the entrance to Benchmark have a 5% grade which is appropriate. This leaves the rest of the driveway fairly steep at almost a 10% grade. Transitional sections of this steepness are allowable by code.

17.6.8: Solid Fuel Burning Device Regulations

Staff: The applicant has indicated that the proposed home does include a fireplace and that it is to run on natural gas.

Chapter 17.7: BUILDING REGULATIONS

17.7.19: Construction Mitigation

Staff: The construction mitigation plan shows required material staging, dumpster, bear-proof trash receptacles, parking and a port a toilet. The construction fencing is indicated on both the east and west sides of the home, but does not continue around the perimeter of the site. The applicant should extend this fencing, both to limit the potential "disturbance creep" as well as for overall site safety. Appropriate silt fencing and wattles are indicated. The applicant should add an area of excavated dirt stockpiles and/or indicate removal of such. No crane is indicated on the CMP, if it is determined that one is required, the applicant shall work with town staff to make sure the crane swing doesn't impede the roadway.

Staff Recommendation: Staff recommends the DRB approve the Initial Architectural and Site Review for Lot 214A, 209 Benchmark Drive, based on the findings and CDC requirements listed in the staff memo of record.

Staff Note: *It should be noted that reasons for approval or rejection should be stated in the findings of fact and motion.*

Proposed Motion:

If the DRB deems this application to be appropriate for approval, Staff requests said approval condition the items listed below in the suggested motion.

I move to approve the Initial Architectural and Site Review for a new single-family home located at Lot 214A, based on the evidence provided within the Staff Report of record dated June 2, 2021, with the following design variations and specific approvals:

Design variations:

- 1) Tandem Parking

DRB Specific Approval:

- 1) GE encroachment for hammerhead, hardscaping and grading

And, with the following conditions:

- 1) Prior to final review, the applicant shall modify the landscaping plan to remove all new plantings from the eastern GE, to increase variety of species and to clarify what species of shrub is to be planted .
- 2) Prior to final review, the applicant shall revise the proposed exterior materials to meet the 35% minimum requirement and to provide an alternative fascia material.
- 3) Prior to final review, the applicant shall revise the construction mitigation plan to extend the construction fencing around the perimeter of the project and add information regarding excavation amounts to be removed and/or a stockpiling plan.
- 4) Prior to final review, the applicant shall revise the lighting plan to provide specifications for the proposed recess lighting and the address monument and shall provide a photometric study.
- 5) Prior to final review, the applicant will revise the address monument to meet all specifications of the CDC.
- 6) Consistent with town building codes, Unenclosed accessory structures attached to buildings with habitable spaces and projections, such as decks, shall be constructed as either non-combustible, heavy timber or exterior grade ignition resistant materials such as those listed as WUIC (Wildland Urban Interface Code) approved products.
- 7) A monumented land survey of the footers will be provided prior to pouring concrete to determine there are no additional encroachments into the GE.
- 8) Prior to the Building Division conducting the required framing inspection, a four-foot (4') by eight-foot (8') materials board will be erected on site consistent with the review authority approval to show:
 - a. The stone, setting pattern and any grouting with the minimum size of four feet (4') by four feet (4');
 - b. Wood that is stained in the approved color(s);
 - c. Any approved metal exterior material;
 - d. Roofing material(s); and
 - e. Any other approved exterior materials
- 9) It is incumbent upon an owner to understand whether above grade utilities and town infrastructure (fire hydrants, electric utility boxes) whether placed in the right of way or general easement, are placed in an area that may encumber access to their lot. Relocation of such above grade infrastructure appurtenances will occur at the owner's sole expense and in coordination with the appropriate entity (fire department, SMPA, Town of Mountain Village) so that the relocated position is satisfactory.

/aw

DEVELOPMENT NARRATIVE
FOR

THE KLURFELD RESIDENCE
LOT 214A
Mountain Village, Colorado

Bercovitz Design, Architects
4-6-2021

This project is a 5 bedroom, 4900 sf home located on a previously subdivided lot on Benchmark Drive. The great room faces the views to the north, and rooms are on 3 levels, including a partially buried lower level. The garage is placed toward the back of the lot, with an Accessory Dwelling Unit above the garage accessed from the side. To achieve ground level access with minimal steps, the driveway was designed to climb to the main level, and the garage and entry are located at this middle level, from which views to the north over trees across the street are more accessible.

The design is contemporary utilizing low pitched roofs, large areas of undisturbed glass, and materials and details that create a clean, simple look, with an asian influence.

Roof pitches general are away from use areas resulting in minimal hazard from snow and ice dumping.

Extensive landscaping has been integrated into the plan, and the structure itself sits within the boundary of the general easements.

DESIGN VARIATIONS REQUESTED:

1. DEVELOPMENT WITHIN THE GENERAL EASEMENT

Because of the narrow nature of the parcel, a vehicular turnaround projects approximately 6 ft. into the east easement to facilitate the necessary turning requirements for a vehicle, thereby preventing the need to back out into Benchmark Drive, a fairly busy street that is fed from other streets above. Additionally, an outdoor terrace is proposed to project 6 ft into the west general easement, allowing the occupants to enjoy a decent sized outdoor use area that captures a view to the northwest. Further it appears that both neighbors on the east and west sides were able to use the general easement to their benefit when they built– driveways, address monument, and possibly roof projections.

2. DRIVEWAY SLOPE

To achieve the proper elevation of the driveway close to the main living level, the driveway up to the entry and garage was required to exceed 8% for a short section, but not exceed 10% on any part of the driveway. The clients specifically requested that no or minimal steps be required to enter the home.

3. STONE USE ON WALLS – LESS THAN 35% (32.5% proposed)

The design integrates stone in the lower portion of the home, allow for a more horizontal wood and glass band to continue above the stone base. We desired to avoid the heavy vertical stone forms that might be required if more stone were to be integrated into the design.



LOT 214A HOUSE

TELLURIDE MOUNTAIN VILLAGE, CO

DRB SET 4-6-2021

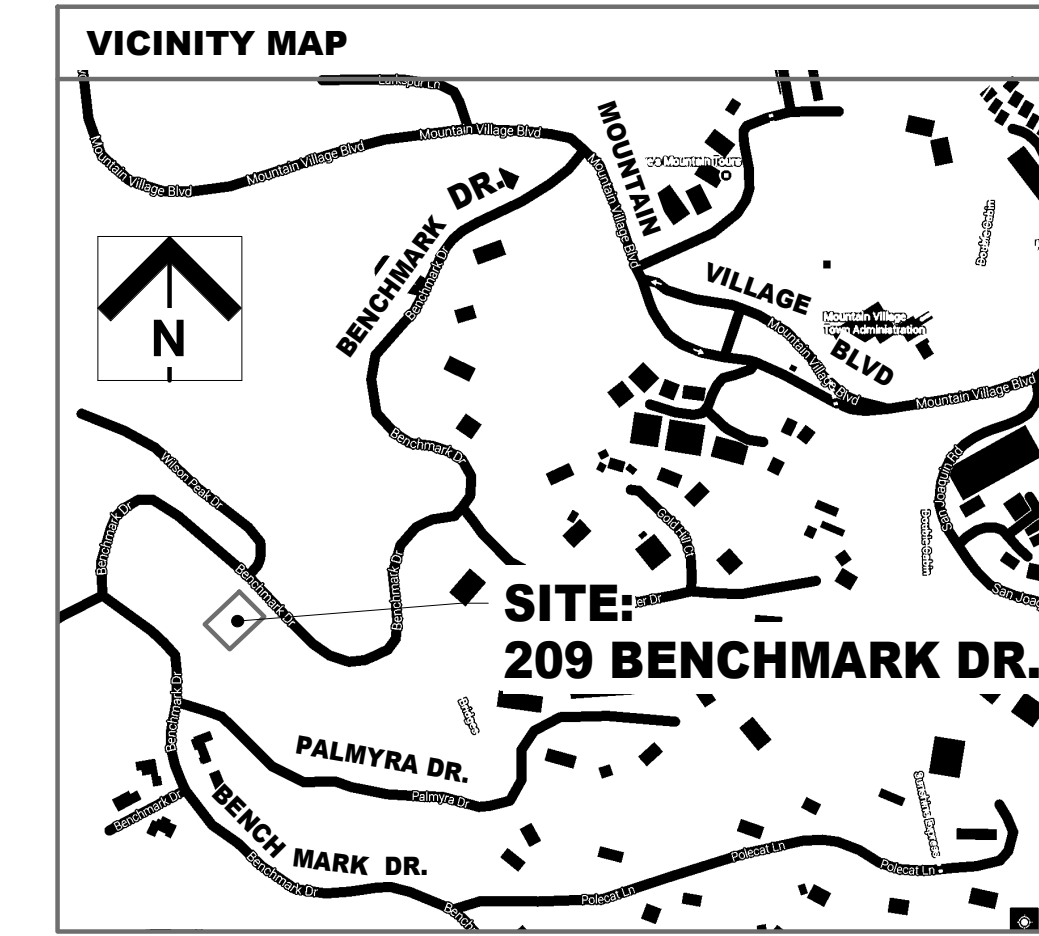

ARCHITECT:
Bercovitz Design Architects
 201 W. Colorado Ave. Suite 205
 Telluride CO, 81435
 (970) 728 - 4555
 Contact: Ron Bercovitz, AIA

214 HOUSE
DATE:
 4-6-2021
 4-9-21

INTERIOR DESIGNER:
 .
 .
 .

STRUCTURAL ENGINEER:
 .
 .
 .

GENERAL CONTRACTOR
 .
 .
 .

LANDSCAPE DESIGNER:
 .
 .
 .

CIVIL ENGINEER:
Uncompahgre Engineering, LLC
 P.O. Box 3945
 Telluride, CO 81435
 970.729.0683
 Contact: David Ballode, PE

MECHANICAL ENGINEER:
 .
 .
 .

SURVEYOR: ALL POINTS LAND SURVEY L.L.C.
 PO BOX 754
 OPHIR, COLORADO 81435
 (970) 708-9694

LOT 214A HOUSE
 TELLURIDE MOUNTAIN VILLAGE, COLORADO

BERCOVITZ DESIGN ARCHITECTS
 201 W. Colorado Ave. Suite 205 TELLURIDE, CO 81435
 (970) 728-4555



3 STREET PERSPECTIVE 3

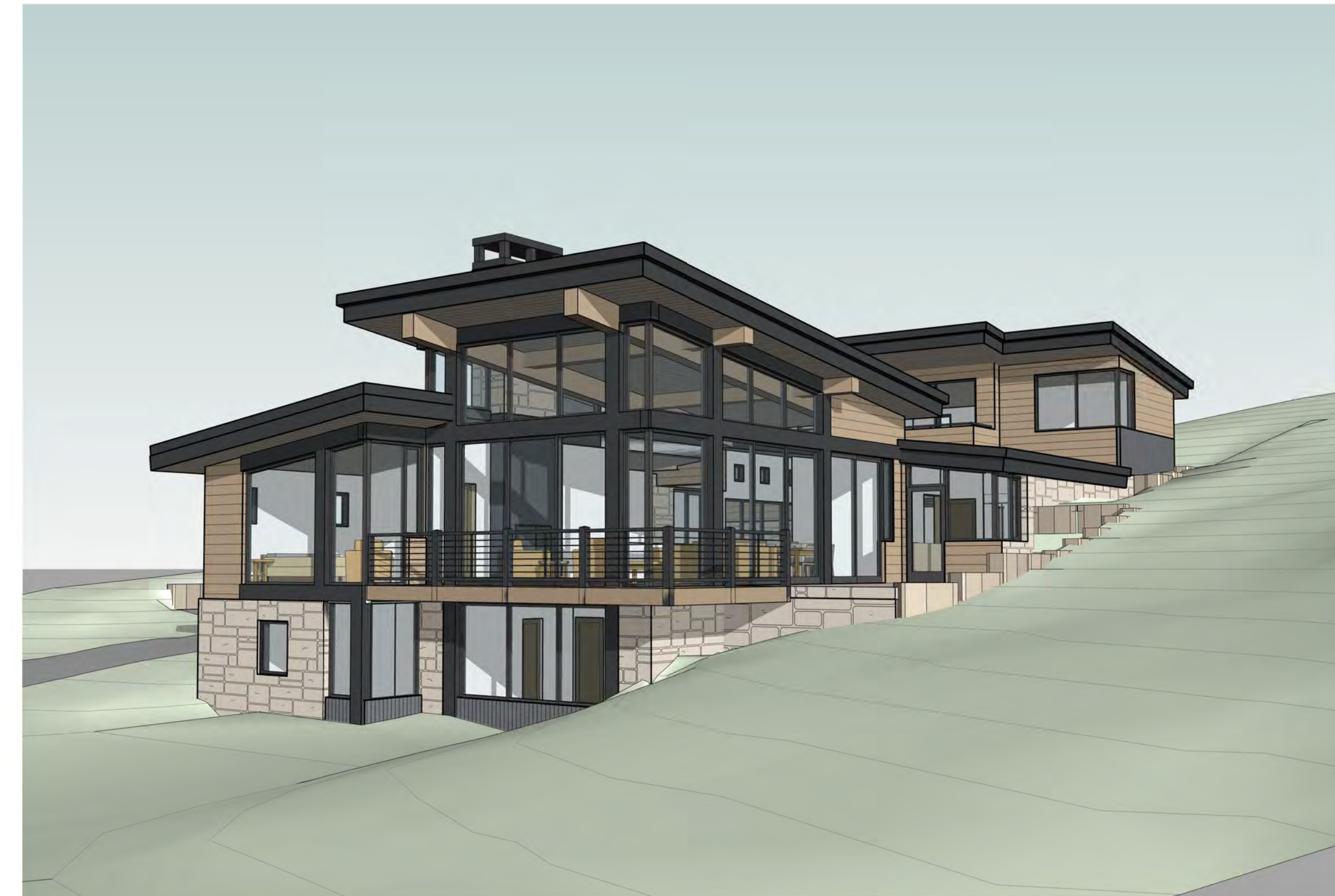

2 STREET PERSPECTIVE 2



4 ISO - NE



1 STREET PERSPECTIVE 1

PROJECT SUMMARY

LOT SIZE:	0.359 AC +/- = 15,638 SF +/-
LOT COVERAGE:	4,566 SF = 29.1% OF LOT AREA
ZONING:	SINGLE FAMILY RESIDENTIAL
MAX. BUILDING HEIGHT:	27.1 FT (PER SHEET 4.3)
AVE. BUILDING HEIGHT:	15.58 FT (PER SHEET 4.3)
STONE SIDING:	32.5% OF TOTAL EXTERIOR
PARKING:	2 INSIDE, 2 OUTSIDE.

AREA SUMMARY

COND. AREA	SF	LEVEL	DESCRIPTION
COND. AREA	1197 SF	LEVEL 0	
COND. AREA	2630 SF	LEVEL 1	
COND. AREA	581 SF	LEVEL 2	GUEST UNIT
COND. AREA	428 SF	LEVEL 2	
COND. AREA	4837 SF		
DECK	150 SF	LEVEL 1	AT LIV RM
DECK	70 SF	LEVEL 2	AT GUEST MASTER
DECK	142 SF	LEVEL 2	AT GUEST UNIT
DECK	363 SF		
GARAGE	578 SF	LEVEL 1	
GARAGE	578 SF		
TERRACE	326 SF	LEVEL 1	
TERRACE	326 SF		

SHEET INDEX

0.1	COVER SHEET
1.1	SITE PLANS
3.1	FLOOR PLANS
3.2	FLOOR PLANS, ROOF PLAN, SCHEDULES
4.1	ELEVATIONS
4.2	ELEVATIONS
4.3	SIDING, HEIGHT, LOT COVERAGE CALCS
5.1	SECTIONS
5.2	SECTIONS
C.1	CIVIL GENERAL NOTES
C.2	CIVIL SITE GRADING AND DRAINAGE
C.3	UTILITIES
S	TREE SURVEY
PH.1	SITE PHOTOS
MT.1	MATERIAL PHOTOS

COVER SHEET

0.1

4/6/2021 11:41:55 AM

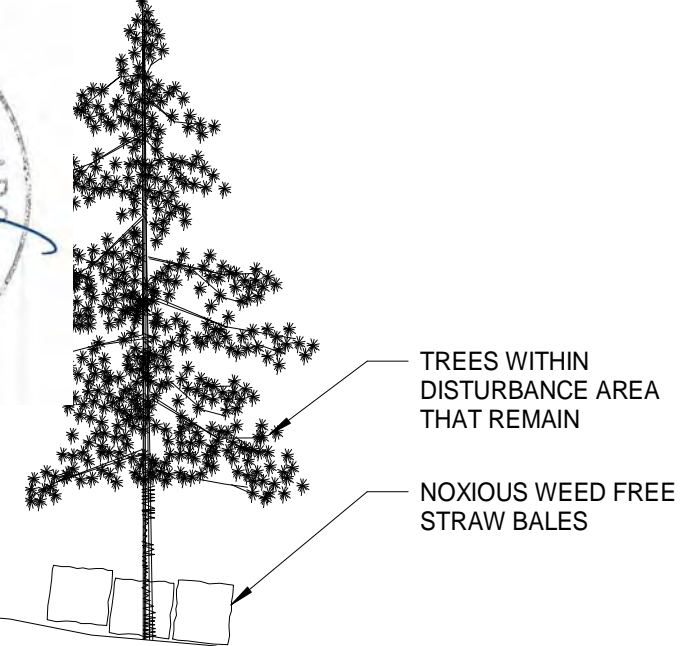
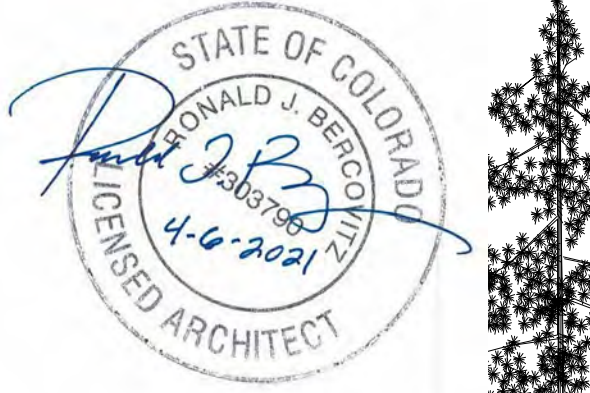

7 TREE PROTECTION DETAIL
SCALE: 12" = 1'-0"

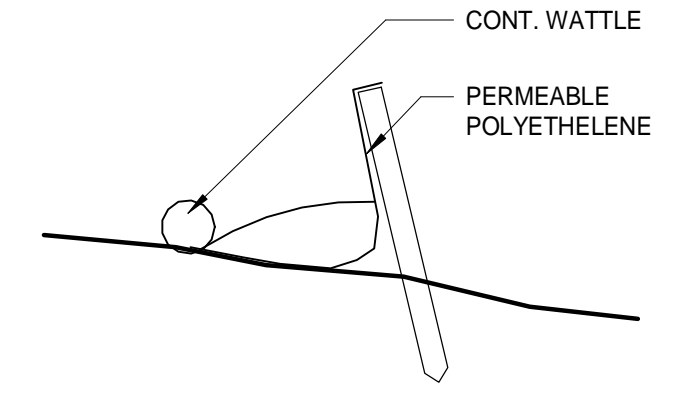

6 SILT FENCE DETAIL
SCALE: 12" = 1'-0"

LANDSCAPE NOTES:
1. SUBMIT FINAL LS PLAN FOR DRB APPROVAL AT FINAL SUBMITTAL
2. SUBMIT IRRIGATION PLAN FOR DRB APPROVAL AT FINAL SUBMITTAL

NATIVE GRASS SEED MIX (GENERAL REVEGETATION):
Native Grass Seed Mix (General Revegetation)
Western Yarrow 5%
Tall Fescue 10%
Arizona Fescue 5%
Hard Fescue 5%
Creeping Red Fescue 10%
Alpine Bluegrass 15%
Canada Bluegrass 10%
Perennial Ryegrass 15%
Slender Wheatgrass 10%
Mountain Brome 15%

LANDSCAPE LEGEND		
	SPRUCE	EXISTING TREE TO BE REMOVED (SEE TREE SURVEY FOR SPECIES AND SIZE)
	ASPEN	EXISTING TREE TO BE REMAIN (SEE TREE SURVEY FOR SPECIES AND SIZE)
	5 GAL SHRUBS	NATIVE GRASSES REVEGETATION
	2" - 3" DIAM RIVER COBBLE	ANNUAL FLOWER BEDS

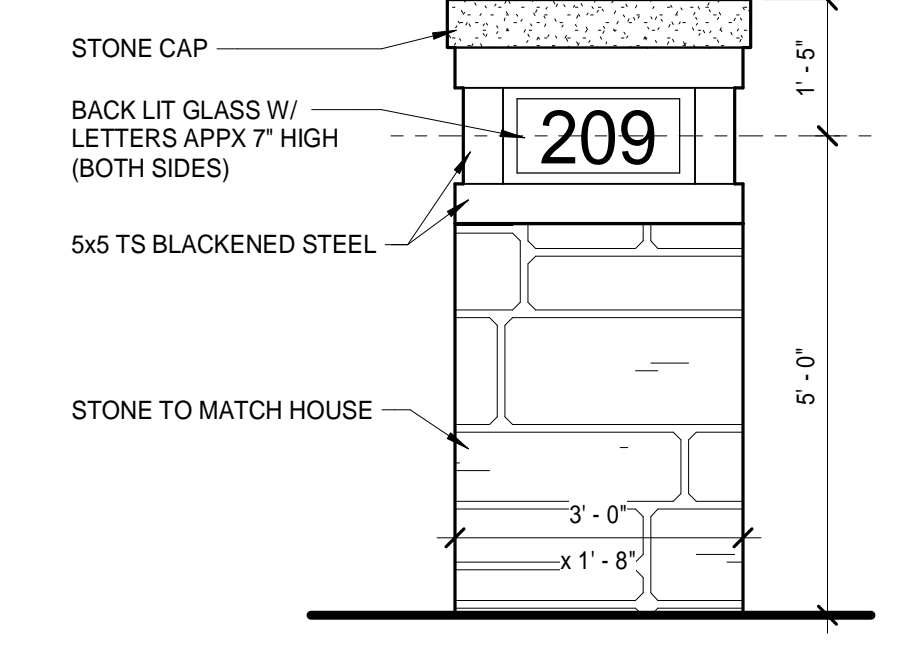

5 ADDRESS MONUMENT
SCALE: 1/2" = 1'-0"



4 TYP EXT. LIGHT
SCALE: 12" = 1'-0"

214 HOUSE
DATE: 4-6-2021
4-9-21

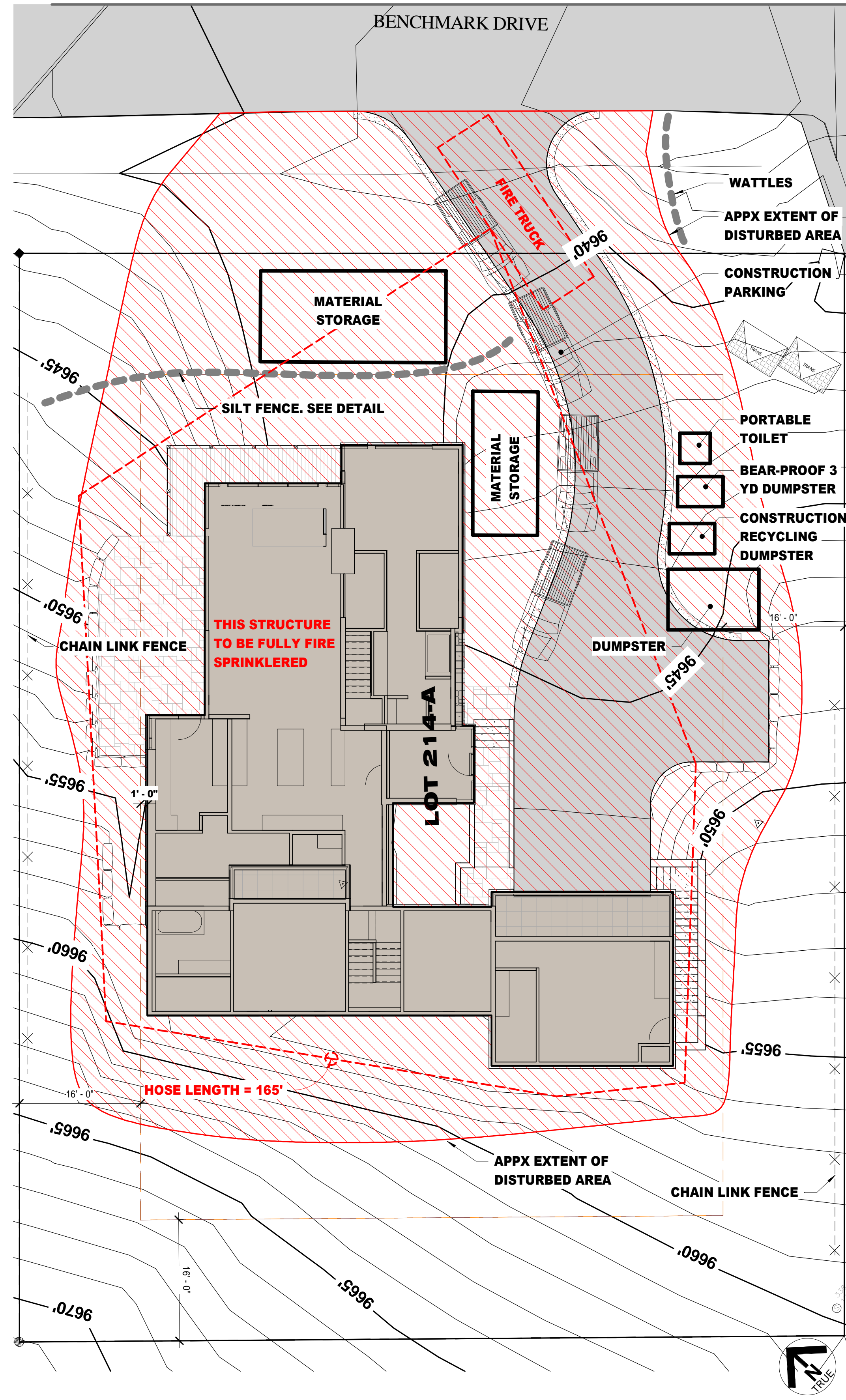

3 CONSTRUCTION MITIGATION PLAN, FIRE DEPT PLAN
SCALE: 1" = 10'-0"

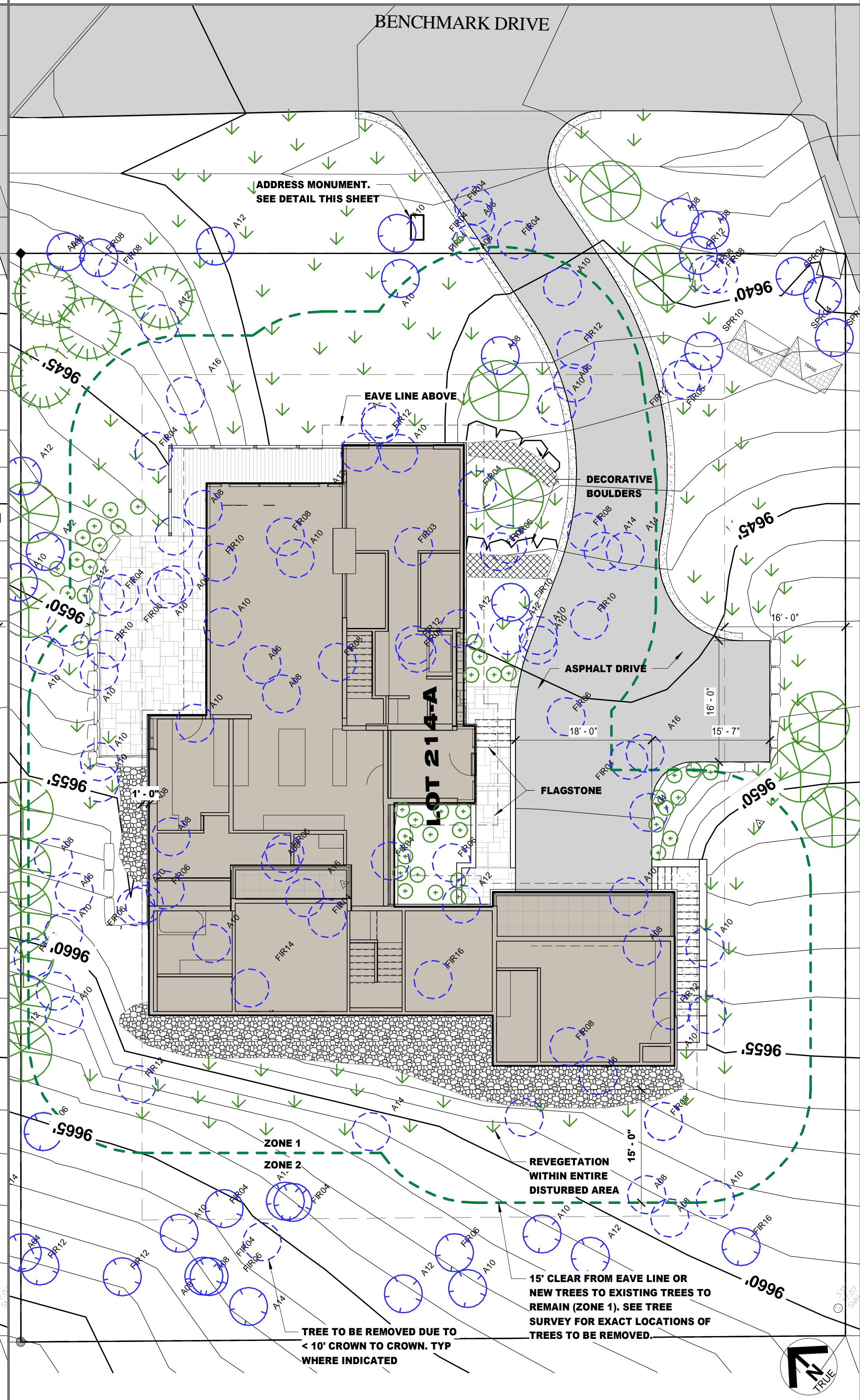

2 CONCEPTUAL LANDSCAPE PLAN / WILDFIRE MITIGATION PLAN
SCALE: 1" = 10'-0"

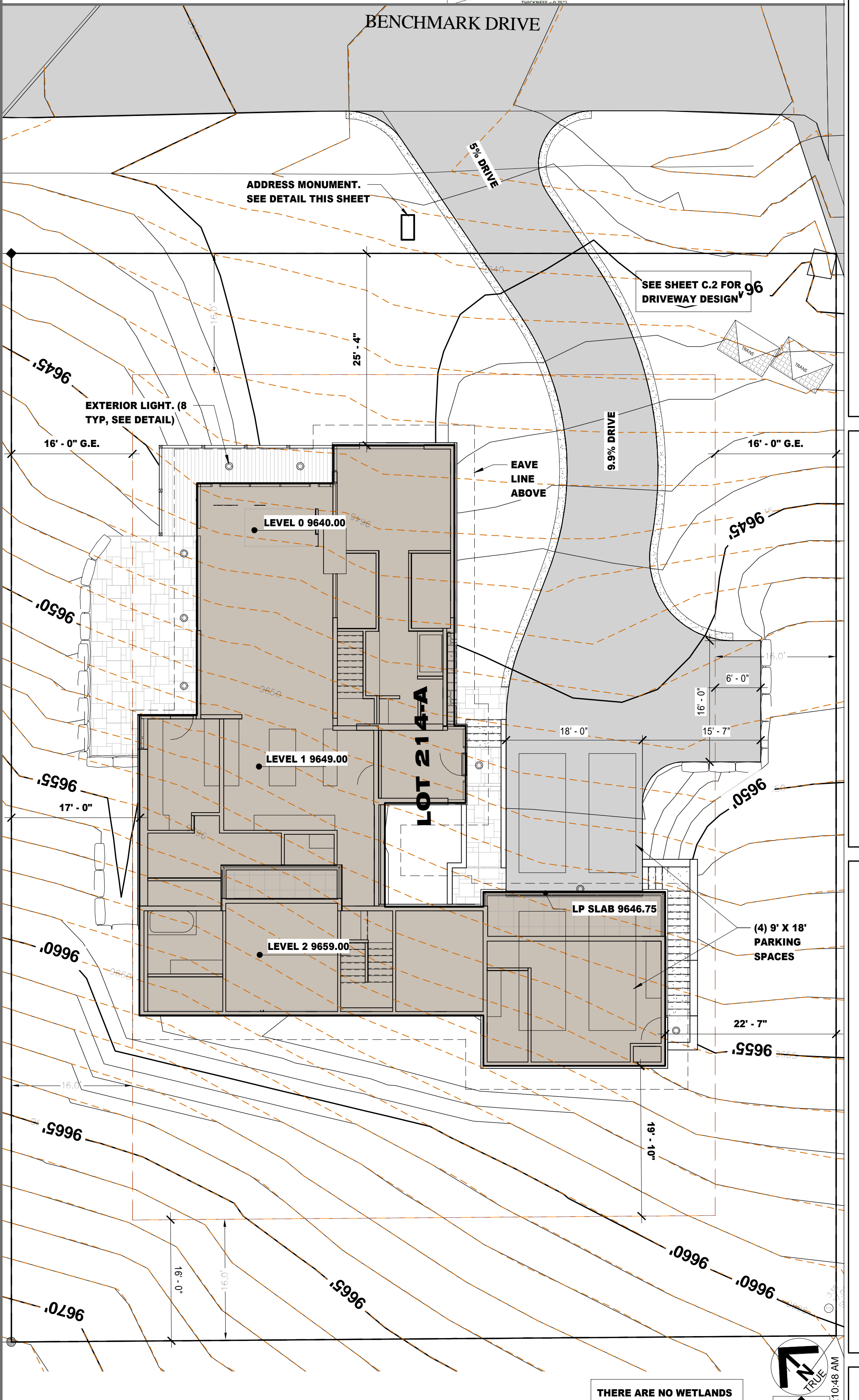

1 SITE / EXTERIOR LIGHTING PLAN
SCALE: 1" = 10'-0"

THERE ARE NO WETLANDS ON THIS SITE

LOT 214A HOUSE
TELLURIDE MOUNTAIN VILLAGE, COLORADO

BERCOVITZ DESIGN ARCHITECTS
201 W. Colorado Ave., Suite 205 TELLURIDE, CO 81435
(970) 728-4555

SITE PLANS

1.1

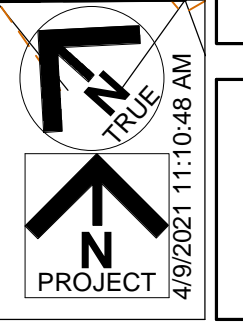

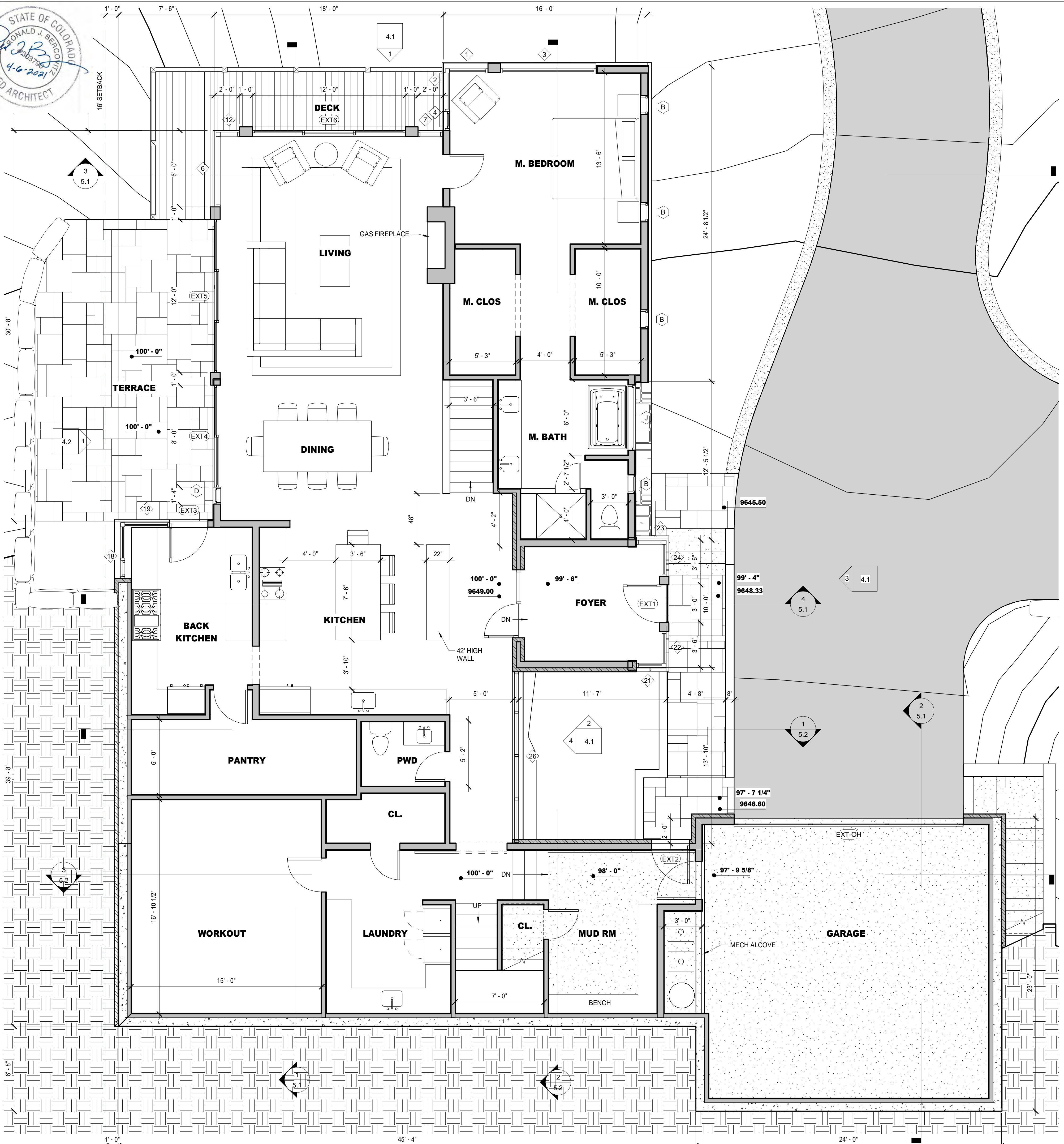

2 LEVEL 1
SCALE: 1/4" = 1'-0"

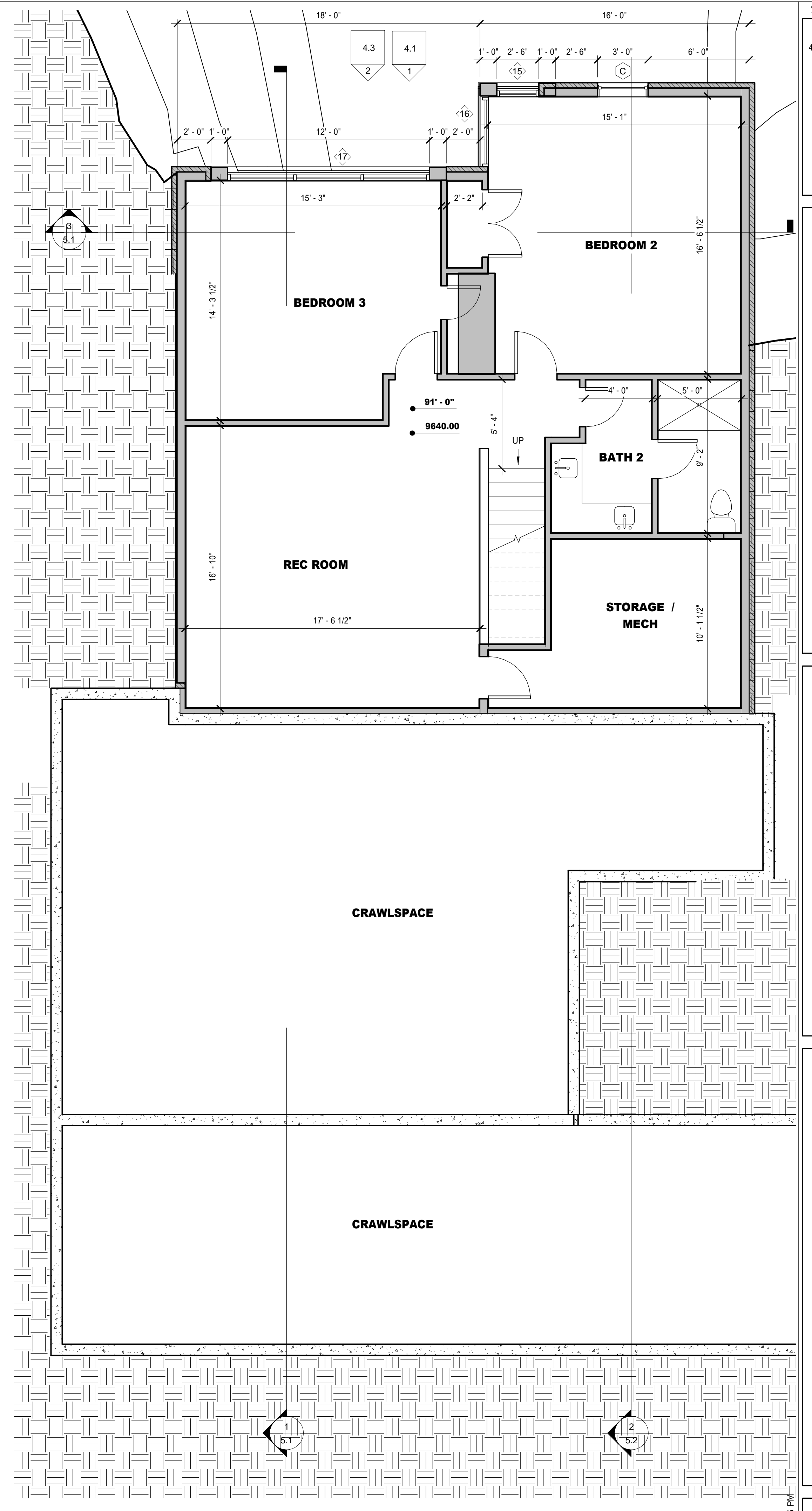
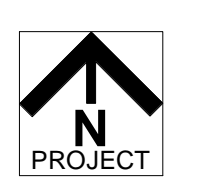

1 LEVEL 0
SCALE: 1/4" = 1'-0"

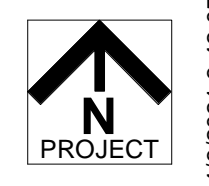

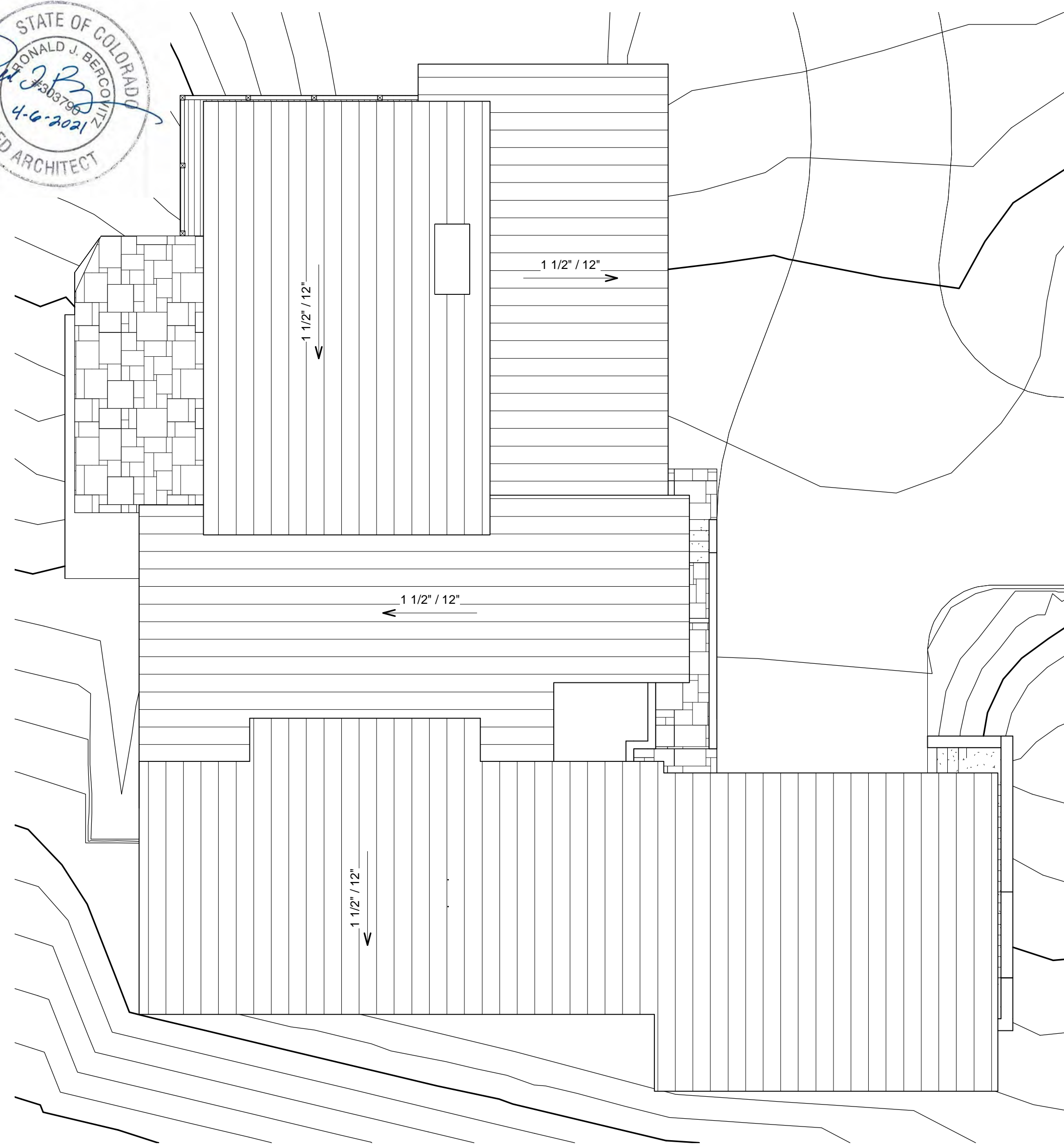

2 ROOF PLAN
SCALE: 1/8" = 1'-0"

EXTERIOR DOOR SCHEDULE

TAG	TYPE	WIDTH	HEIGHT	SWING	JAMB	COMMENTS
EXT1	Single glass	3'-0"	7'-10"			
EXT2	Single glass	3'-0"	7'-0"			
EXT3	Single glass	3'-0"	7'-0"			
EXT4	Sliding Glass 2panel	8'-0"	9'-0"			
EXT5	Sliding Glass 3panel	12'-0"	9'-0"			
EXT6	Sliding Glass 3panel	12'-0"	9'-0"			
EXT7	56	2'-8"	7'-10"			
EXT8	Sliding Glass 3panel	12'-0"	8'-0"			
EXT9	Sliding Glass 2panel	8'-0"	8'-0"			
EXT10	Single glass	3'-0"	8'-0"			
EXT-OH	Overhead-Sectional	18'-0"	8'-0"			

STOREFRONT WINDOW SCHEDULE

TAG	TYPE	WIDTH	HEIGHT	LOCATION
1	Curtain Wall	2'-8"	7'-10"	FOYER
2	Curtain Wall	3'-4 1/4"	12'-10"	M. BEDROOM
3	Curtain Wall	3'-4 1/4"	9'-0"	M. BEDROOM
4	Curtain Wall	7'-6"	12'-10"	M. BEDROOM
5	Curtain Wall	1'-6"	9'-0"	M. BEDROOM
6	Curtain Wall	12'-0 1/8"	5'-2"	LIVING RM
7	Curtain Wall	5'-10 1/2"	9'-0"	LIVING RM
8	Curtain Wall	2'-2 3/4"	9'-0"	LIVING RM
9	Curtain Wall	5'-10 1/4"	9'-0"	LIVING RM
10	Curtain Wall	12'-6"	9'-0"	LIVING RM
11	Curtain Wall	1'-10 1/4"	5'-2"	LIVING RM
12	Curtain Wall	2'-2 3/4"	5'-2"	LIVING RM
13	Curtain Wall	1'-10 1/4"	9'-0"	LIVING RM
14	Curtain Wall	5'-9 1/4"	3'-5 25/32"	LIVING RM
15	Curtain Wall	5'-9 9/16"	3'-5 25/32"	LIVING RM
16	Curtain Wall	2'-6"	6'-0"	BEDROOM 2
17	Curtain Wall	4'-6 5/8"	6'-0"	BEDROOM 2
18	Curtain Wall	12'-0"	5'-10 3/4"	BEDROOM 3
19	Curtain Wall	4'-4 1/2"	4'-9 1/4"	BACK KITCHEN
20	Curtain Wall	3'-10 1/4"	6'-0"	BACK KITCHEN
21	Curtain Wall	3'-0"	2'-0"	BACK KITCHEN
22	Curtain Wall	2'-4"	13'-4"	FOYER
23	Curtain Wall	2'-10"	12'-9 1/4"	FOYER
24	Curtain Wall	2'-4"	13'-6"	FOYER
25	Curtain Wall	2'-10"	12'-9 1/4"	FOYER
26	Curtain Wall	3'-0"	3'-11 1/4"	FOYER
27	Curtain Wall	14'-1 1/2"	4'-4"	HALL
28	Curtain Wall	3'-8 1/8"	5'-0"	GUEST MASTER
29	Curtain Wall	7'-4 7/8"	5'-0"	GUEST MASTER
30	Curtain Wall	4'-0"	8'-0"	GUEST UNIT
31	Curtain Wall	4'-0"	8'-0"	GUEST UNIT
32	Curtain Wall	1'-11 3/4"	5'-0"	GUEST UNIT
33	Curtain Wall	6'-11 3/4"	5'-0"	GUEST UNIT
34	Curtain Wall	2'-11 3/4"	5'-0"	GUEST UNIT

WINDOW SCHEDULE

TYPE MARK	WIDTH	HEIGHT	TYPE
A	1'-6"	1'-6"	Awning
A	1'-6"	1'-6"	Awning
B	1'-6"	2'-6"	Casement
B	1'-6"	2'-6"	Casement
B	1'-6"	2'-6"	Casement
B	1'-6"	2'-6"	Casement
B	1'-6"	2'-6"	Casement
B	1'-6"	2'-6"	Casement
B	1'-6"	2'-6"	Casement
B	1'-6"	2'-6"	Casement
B	1'-6"	2'-6"	Casement
C	3'-0"	3'-6"	Casement
C	3'-0"	3'-6"	Casement
D	1'-4"	6'-0"	Casement
E	1'-4"	5'-8"	Storefront casement
E	1'-3"	4'-5 1/4"	Storefront casement
J	5'-2"	2'-6"	Fixed

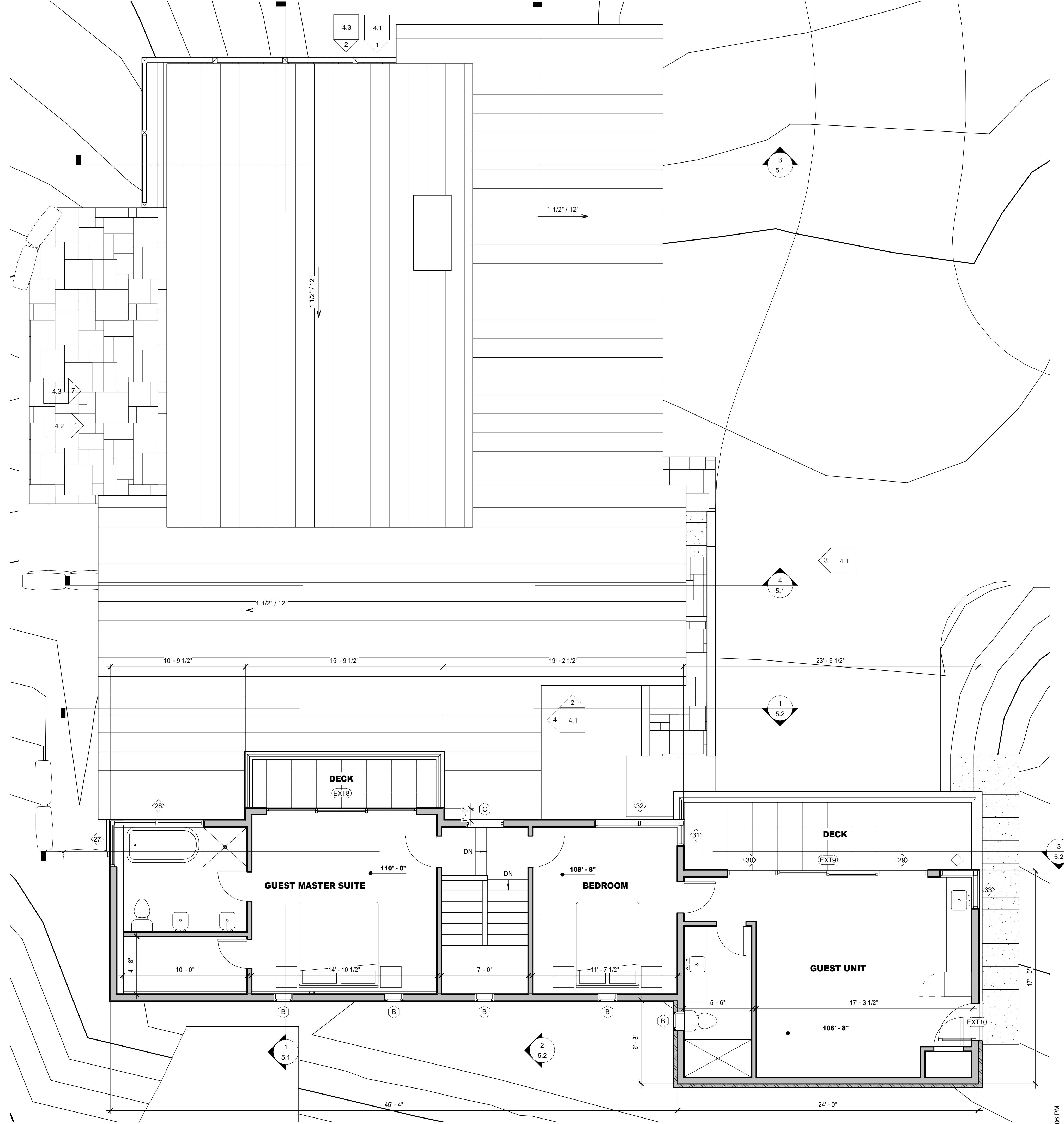

1 LEVEL 2
SCALE: 1/4" = 1'-0"

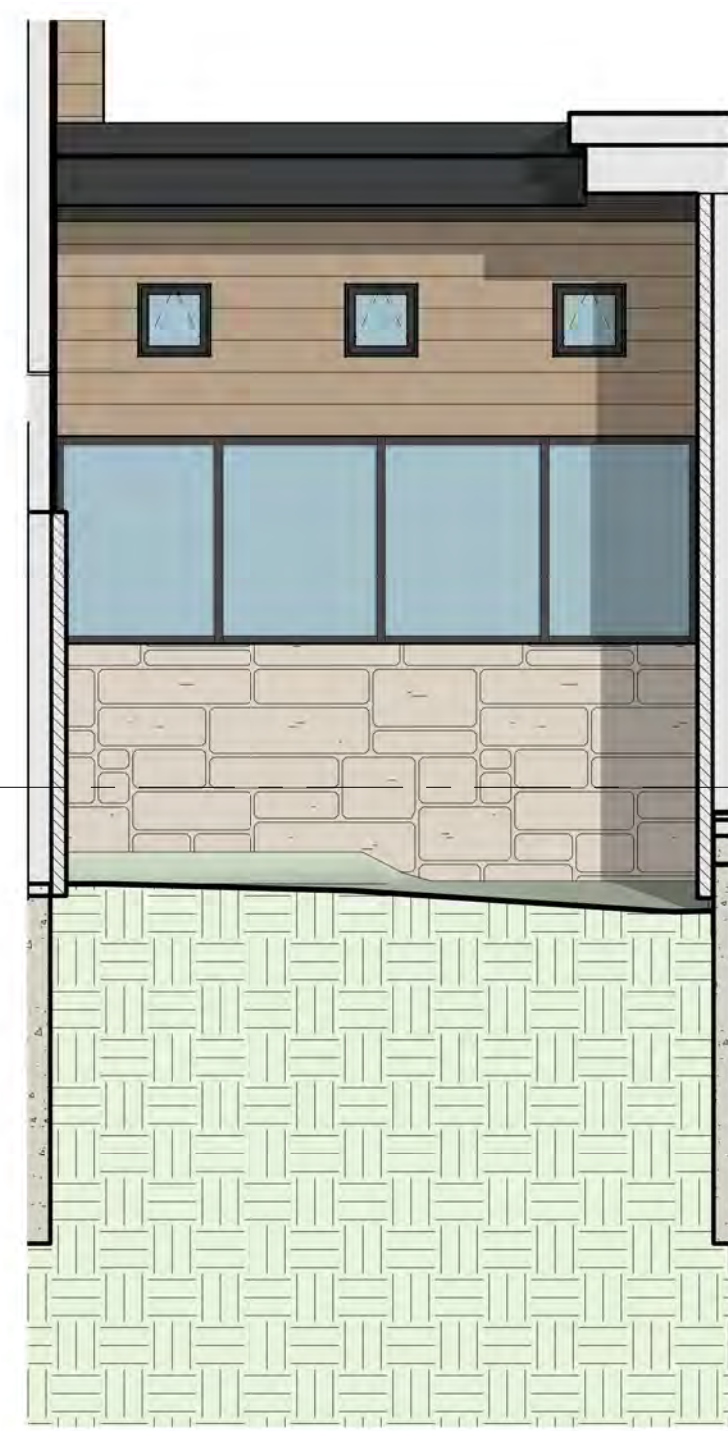

4 HALL EAST
SCALE: 1/4" = 1'-0"



3 EAST ELEVATION
SCALE: 1/4" = 1'-0"

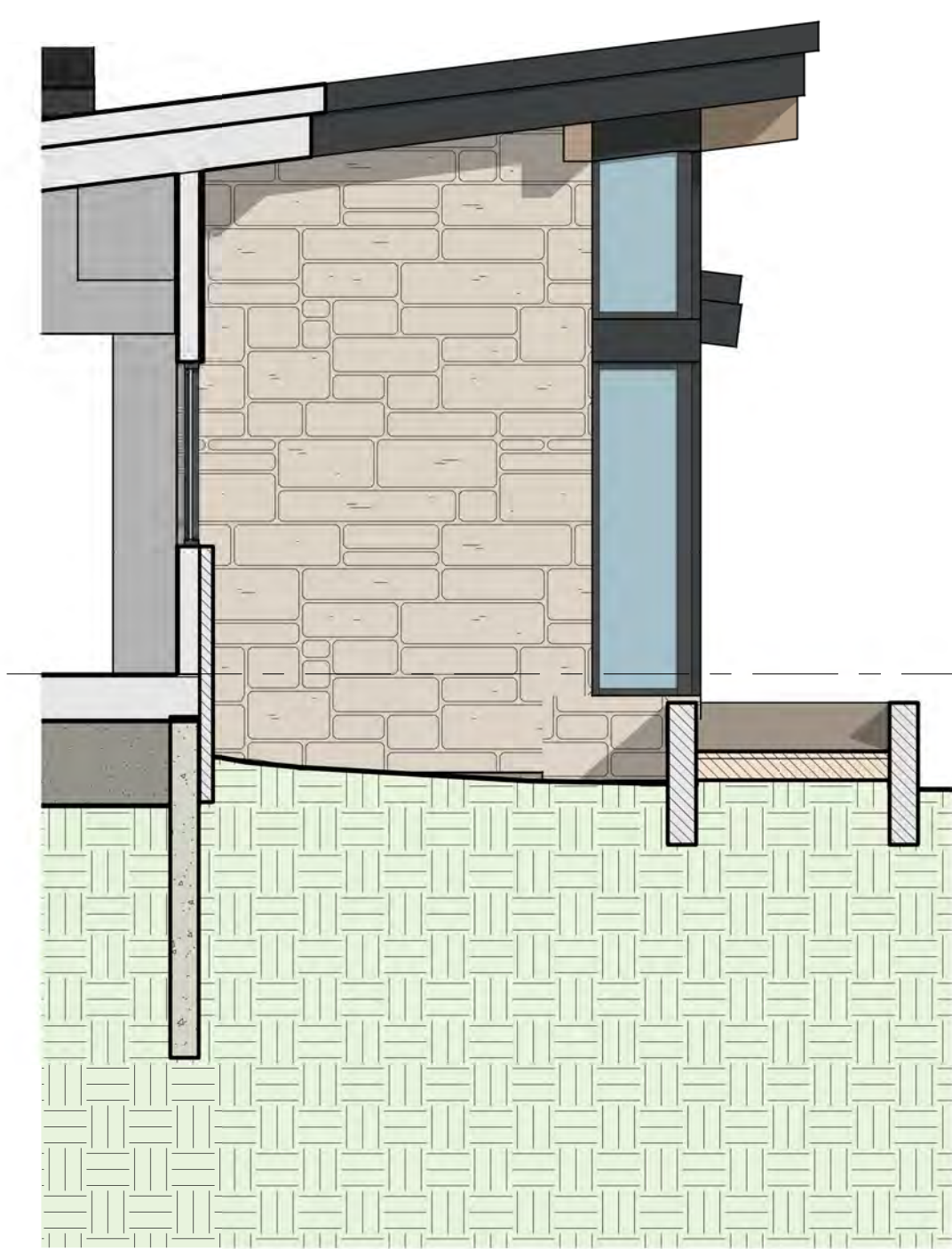

2 FOYER SOUTH
SCALE: 1/4" = 1'-0"



1 NORTH ELEVATION
SCALE: 1/4" = 1'-0"

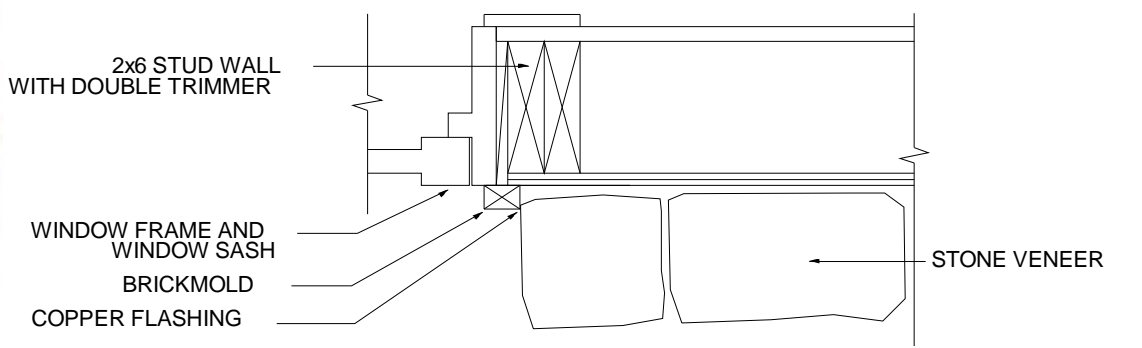

A DOOR JAMB DETAIL
SCALE 1 1/2"=1'-0" TYPICAL

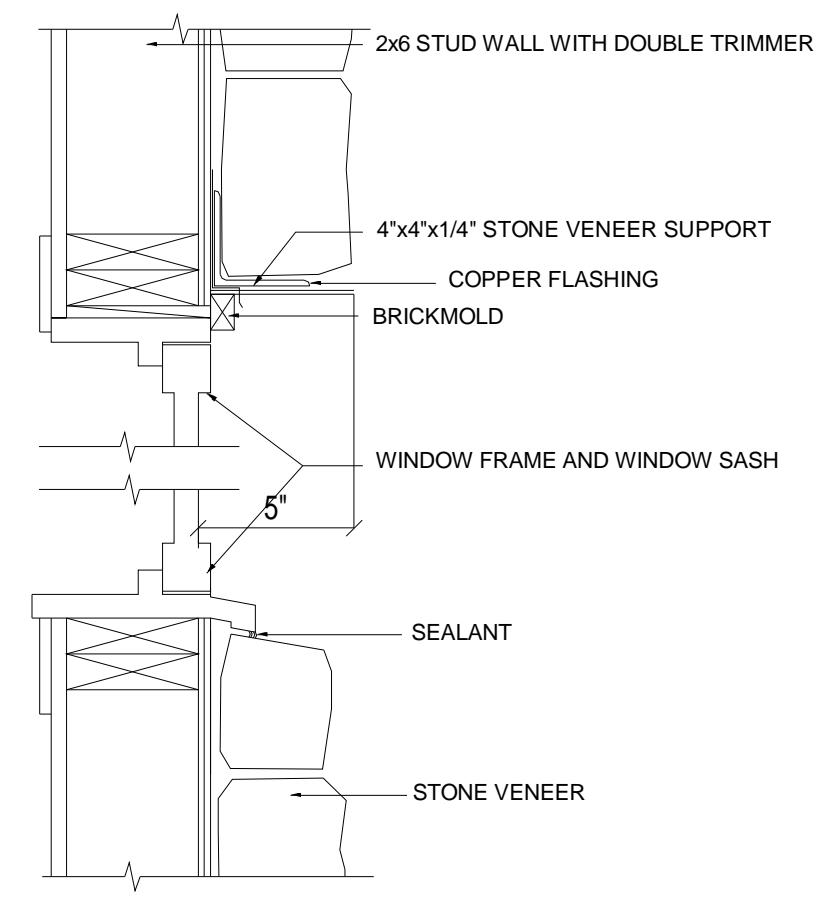

B WINDOW HEAD/SILL DETAIL
SCALE 1 1/2"=1'-0" TYPICAL

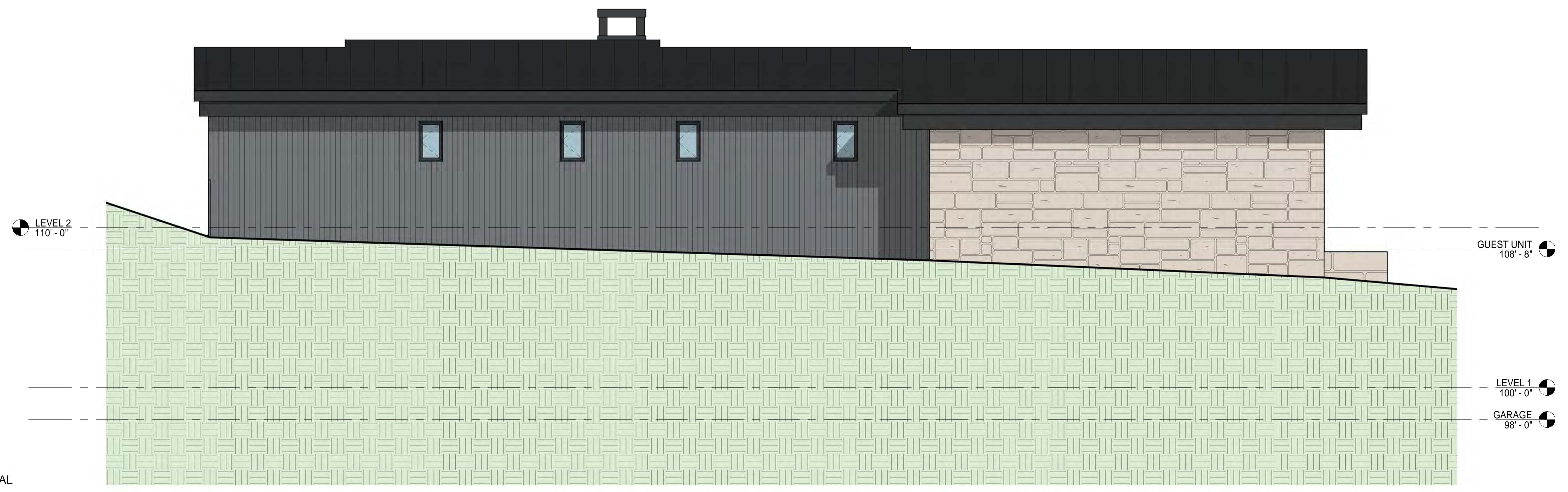

2 SOUTH ELEVATION
SCALE: 1/4" = 1'-0"

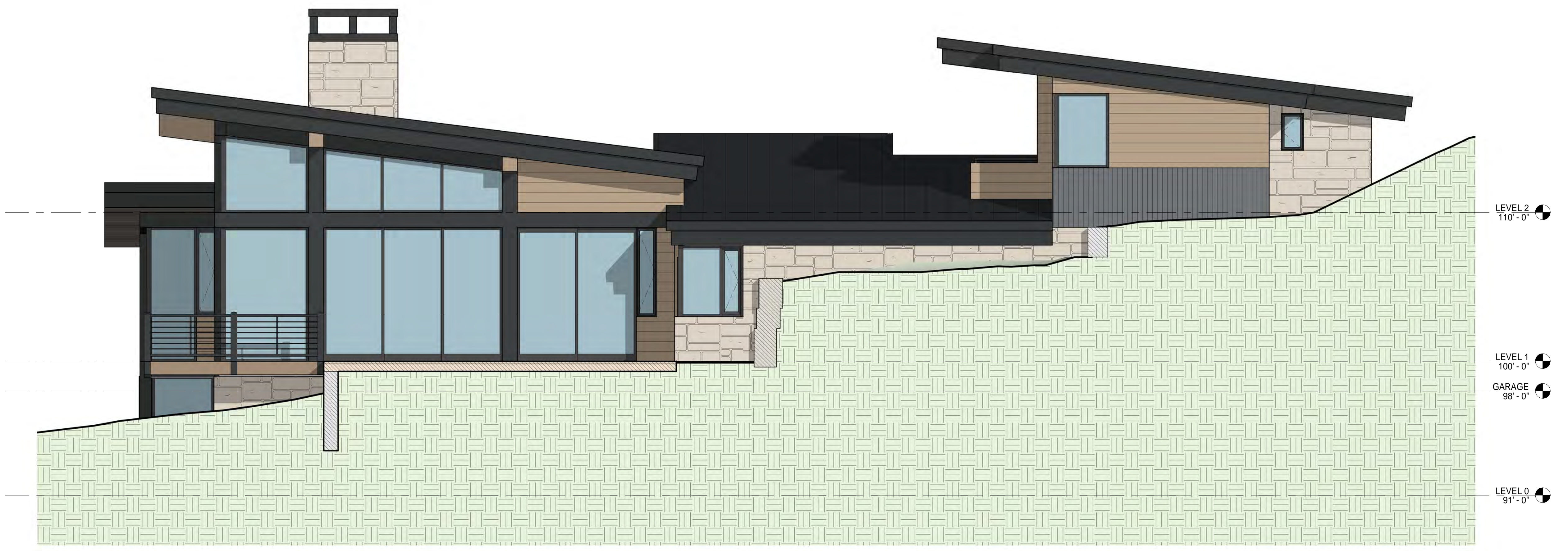

1 WEST ELEVATION
SCALE: 1/4" = 1'-0"



SIDING CALC LEGEND

OTHER SIDING: [diagonal lines]

STONE1 SIDING: [blue diagonal lines]

STONE2 BOULDER: [green diagonal lines]

METAL SIDING: [orange diagonal lines]

WINDOWS/DOORS: [green outline]

MAXIMUM HEIGHT CALCULATION

HIGHEST EAVE HEIGHT: 27.1'

LOWEST PRE-CONSTRUCTION GRADE BELOW HIGHEST EAVE HEIGHT: 9644.0'

MAXIMUM = 27.1'

AVERAGE HEIGHT CALCULATION

MARK	HT IN FEET
1	27.1
2	18.6
3	15.6
4	14.3
5	16.3
6	15.1
7	23.6
8	22.4
9	14.6
10	12.1
11	11.8
12	11.5
13	11.1
14	9.5
15	5.6
15a	12.5
16	15.8
17	23.2
280.5	
15.58	AVERAGE HT.

SIDING CALCULATIONS

ELEVATION	STONE1	STONE2	METAL	WOOD/TRIM	WIN/DOOR	GRAND TTL
WEST	182	77	59	223	430	
SOUTH	229	0	373	0	15	
EAST	506	0	0	495	288	
ENTRY SOUTH	145	0	0	30	30	
NORTH	190	39	20	203	487	
NORTH-REAR	278	0	0	355	407	
TOTALS	1530	116	452	1306	1657	5061
PCT OF SIDING	30.2%	2.3%	8.9%	25.8%	32.7%	
TTL STONE PCT	32.52%					

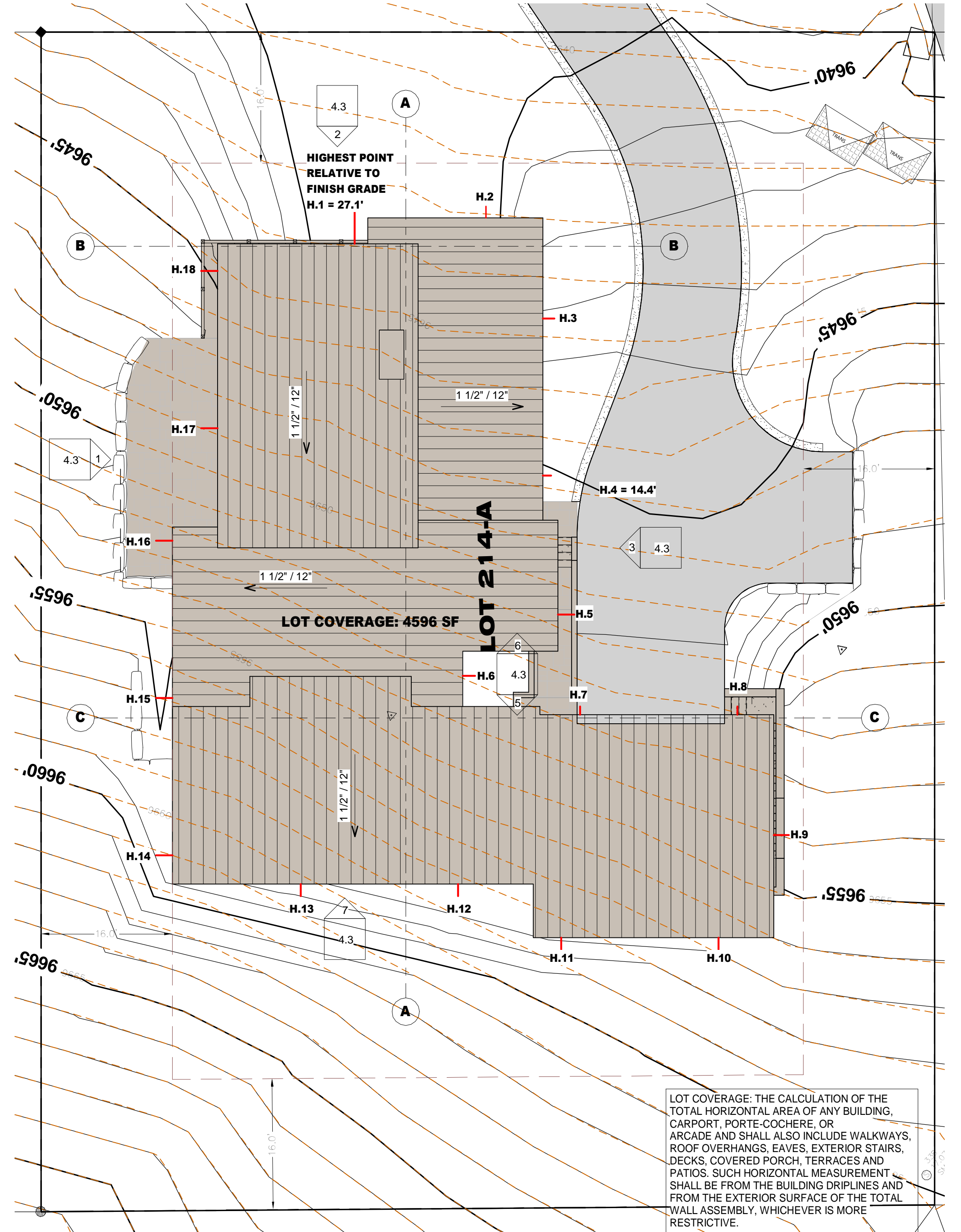

4 HEIGHT / LOT COVG CALCS
SCALE: 1" = 10'-0"

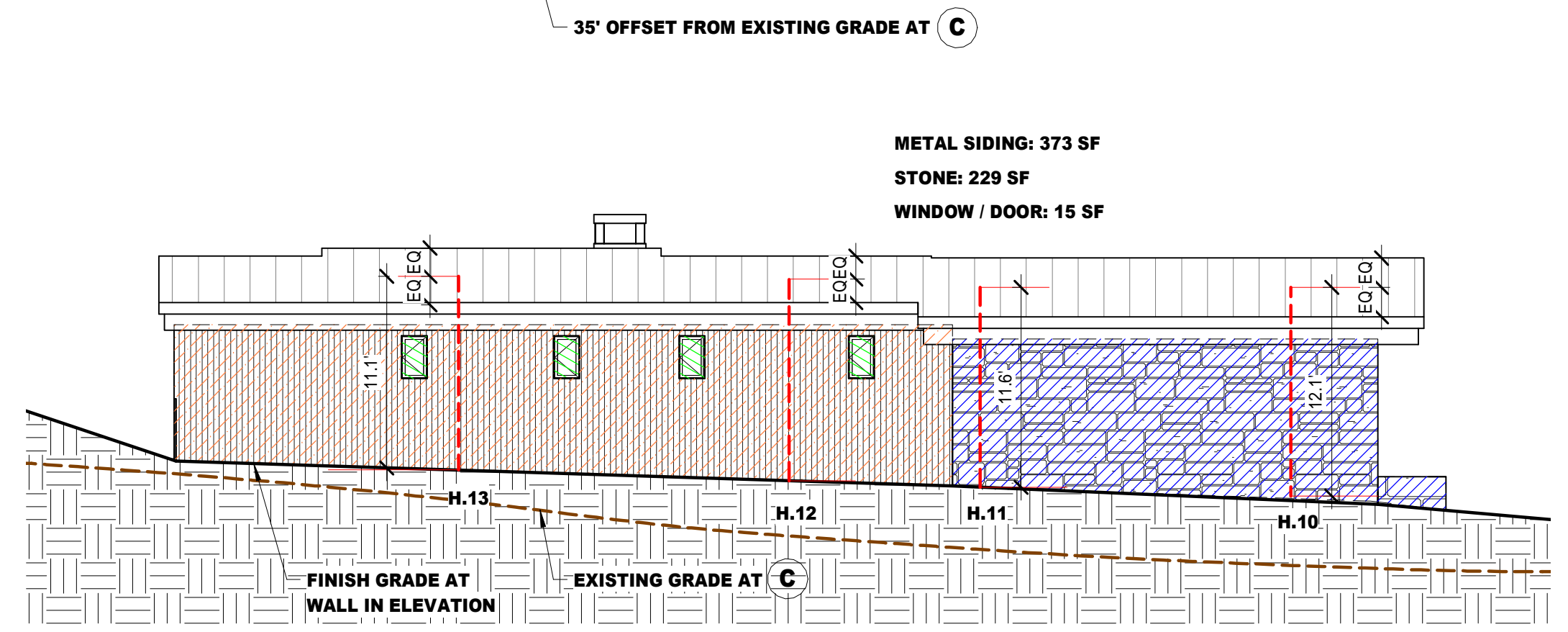

7 SIDING CALC SOUTH
SCALE: 1/8" = 1'-0"

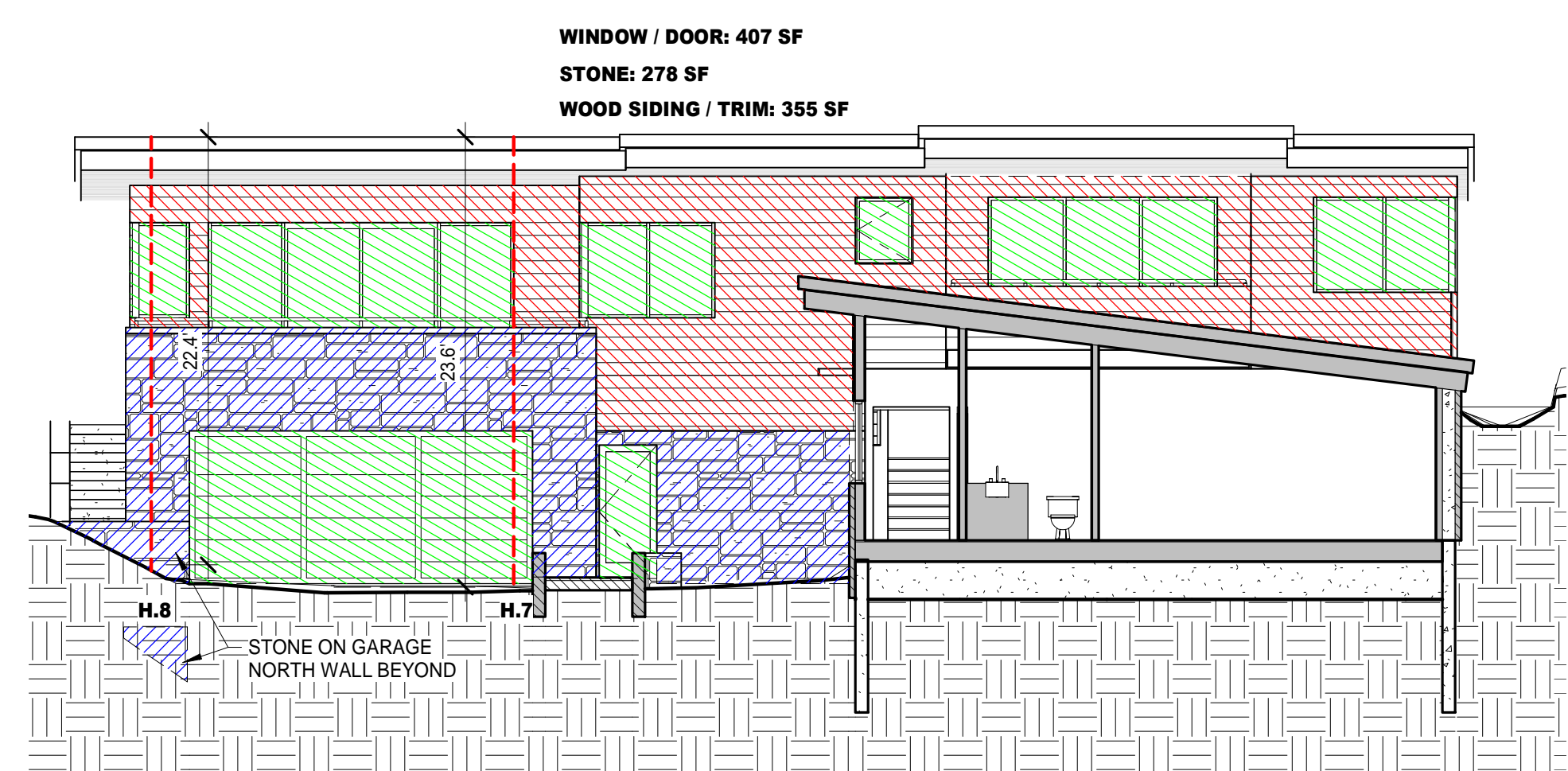

5 SIDING CALC NORTH-REAR
SCALE: 1/8" = 1'-0"

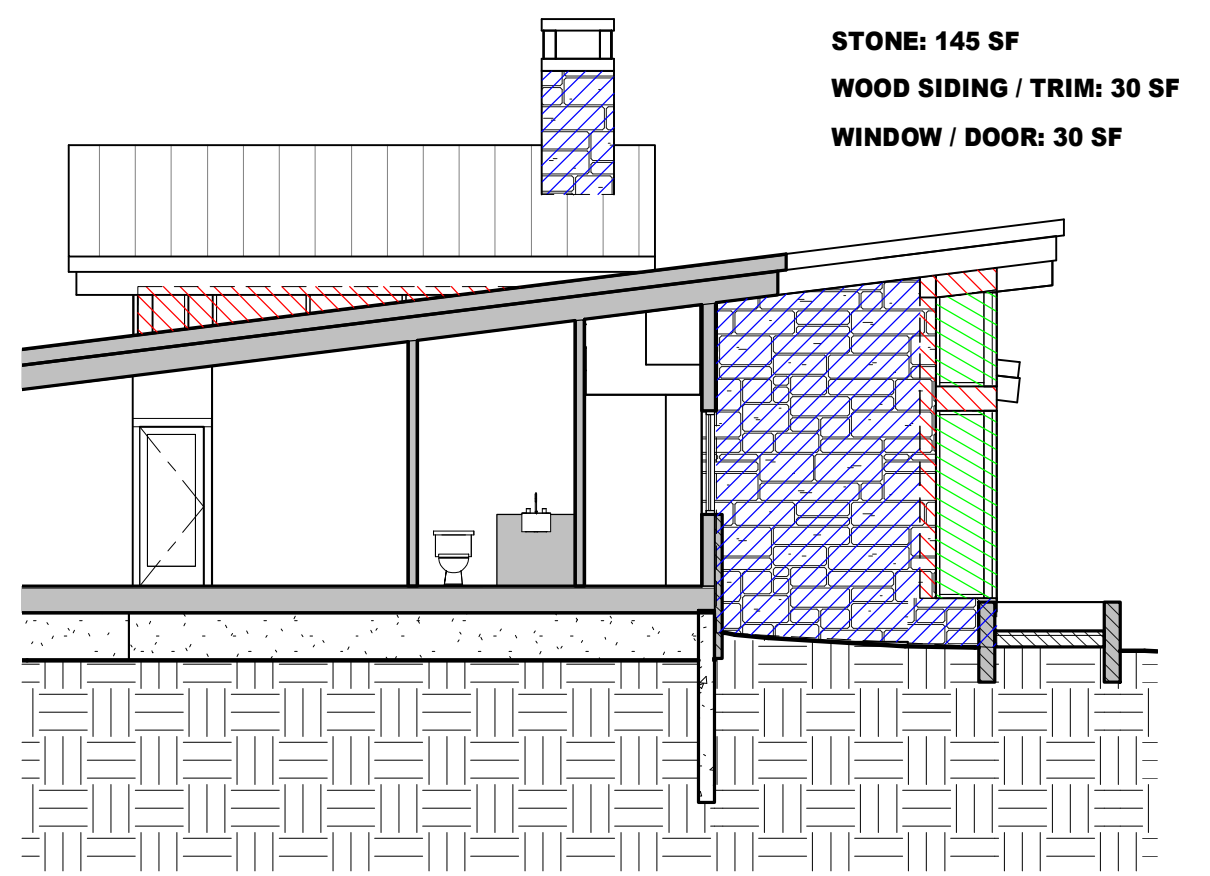

6 SIDING CALC ENTRY S.
SCALE: 1/8" = 1'-0"

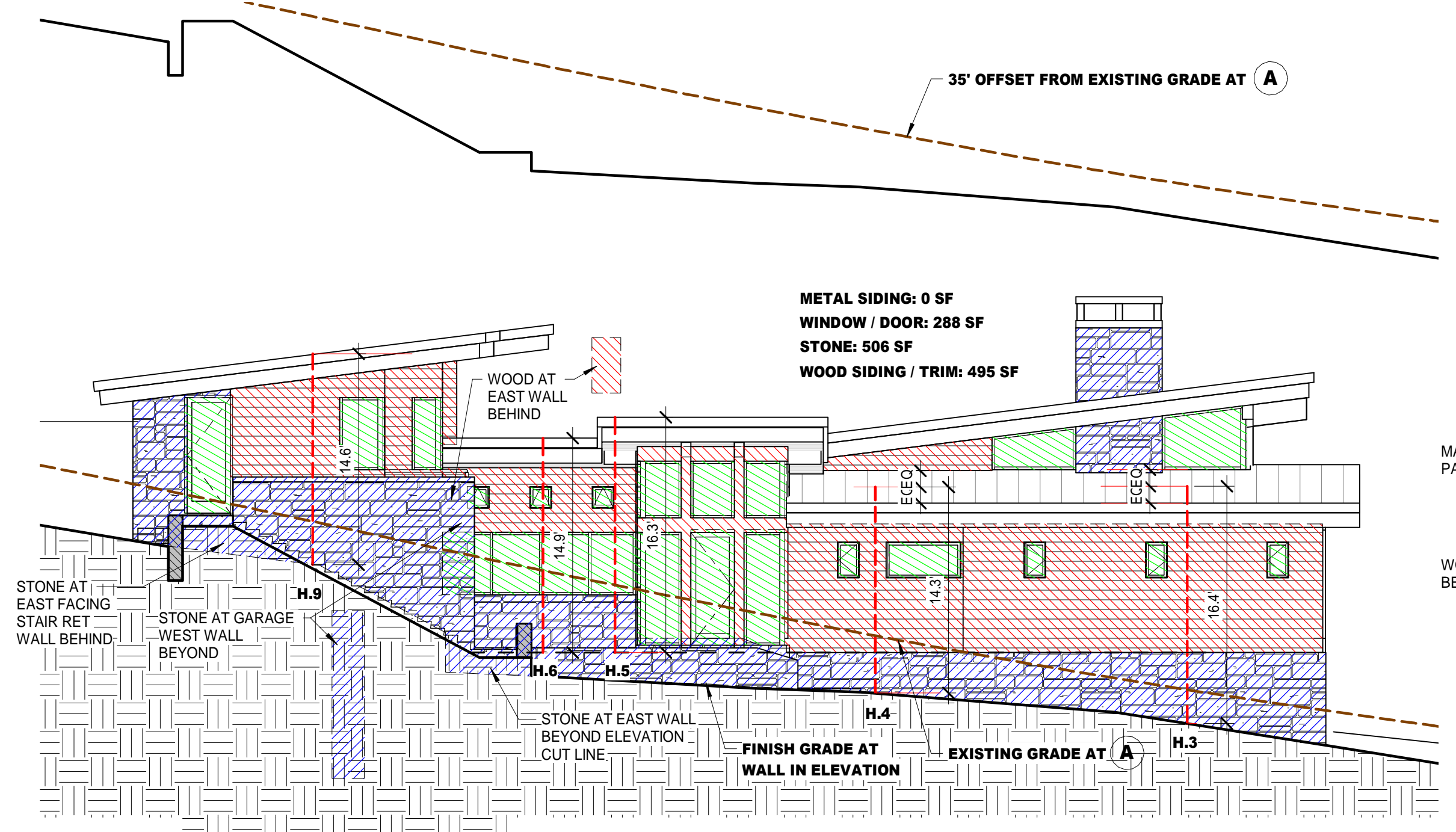

3 SIDING CALC EAST
SCALE: 1/8" = 1'-0"

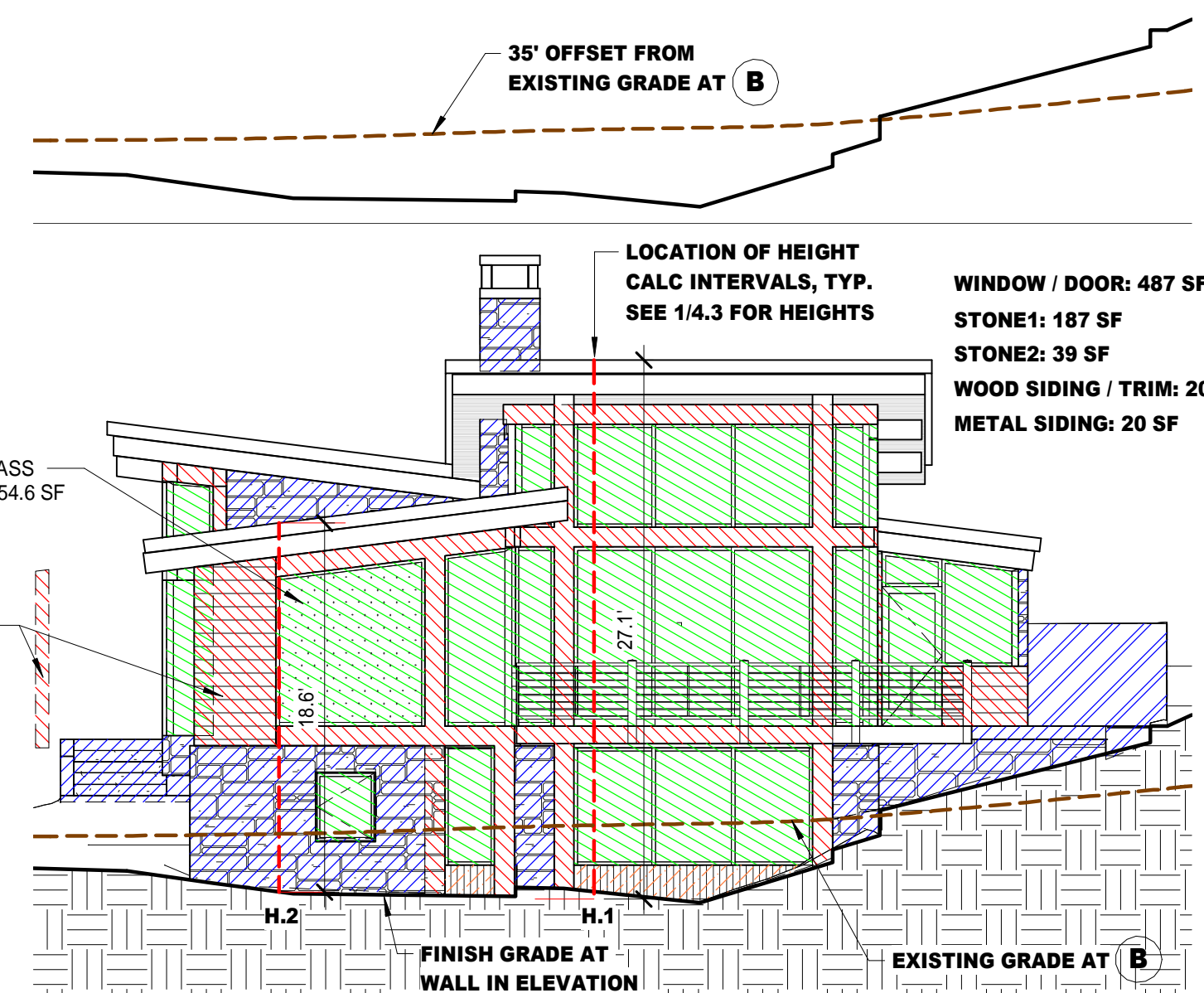

2 SIDING CALC NORTH
SCALE: 1/8" = 1'-0"

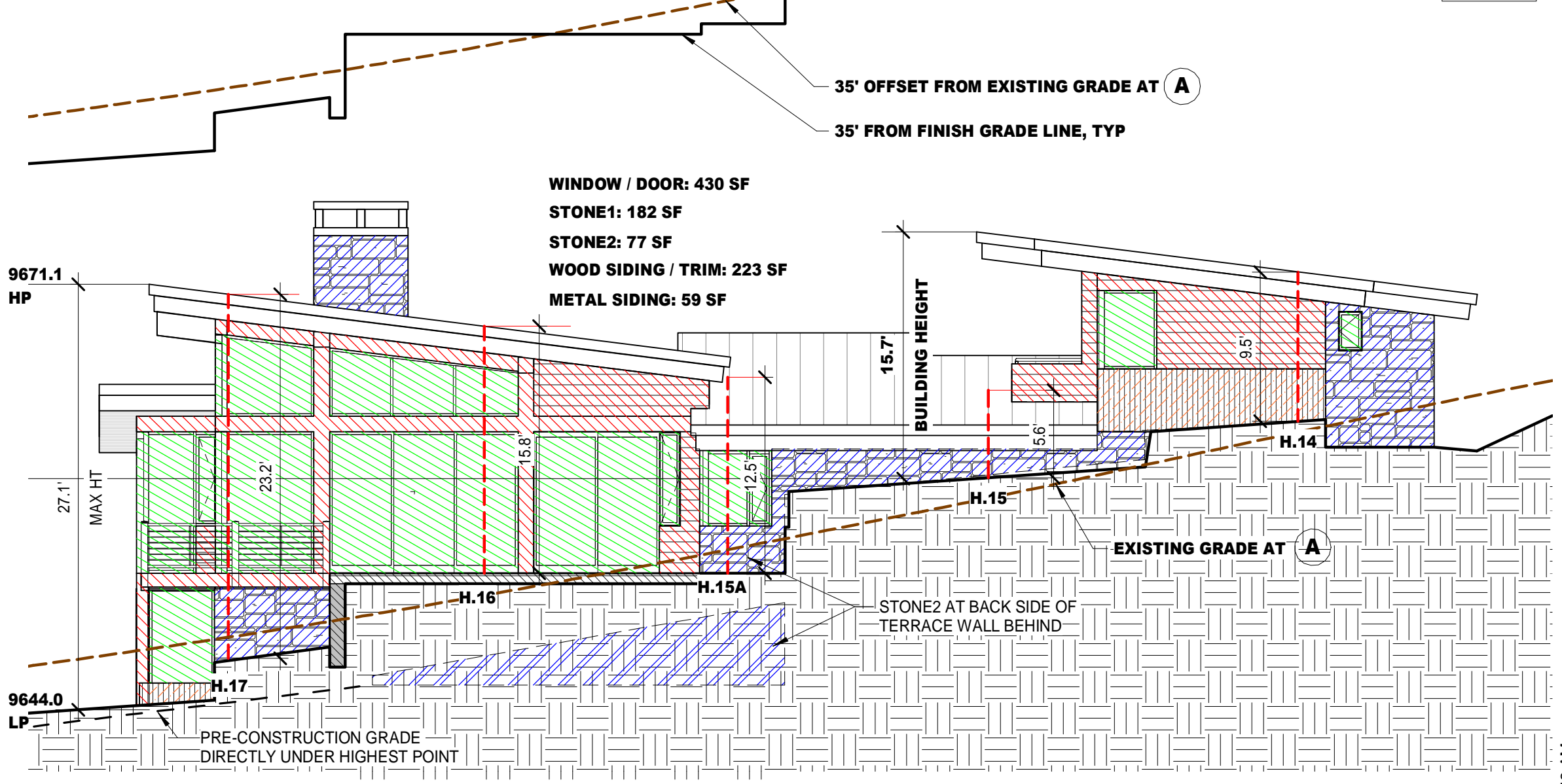

1 SIDING CALC WEST
SCALE: 1/8" = 1'-0"

4/9/2021 11:56:43 AM

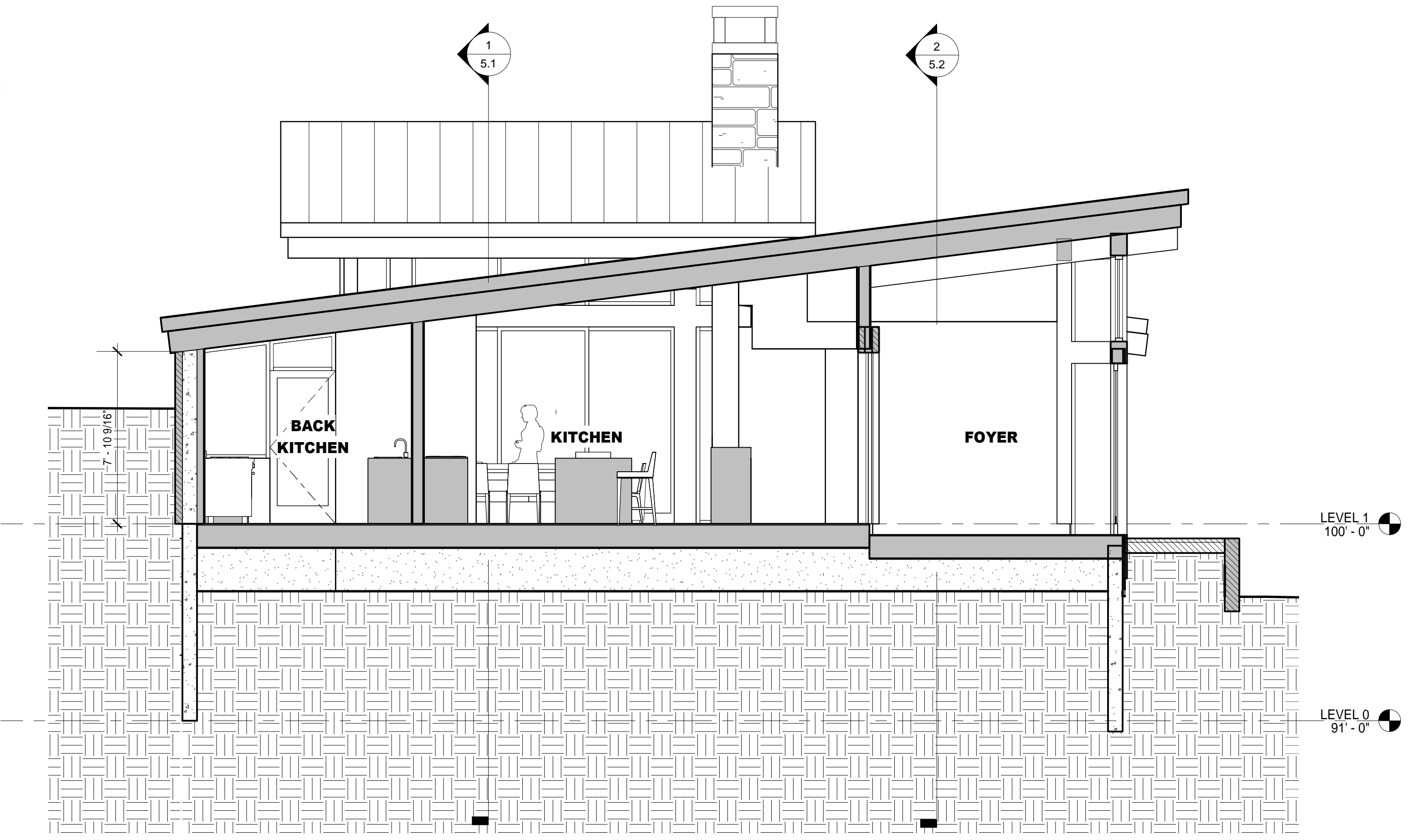

4 SECTION C
SCALE: 1/4" = 1'-0"

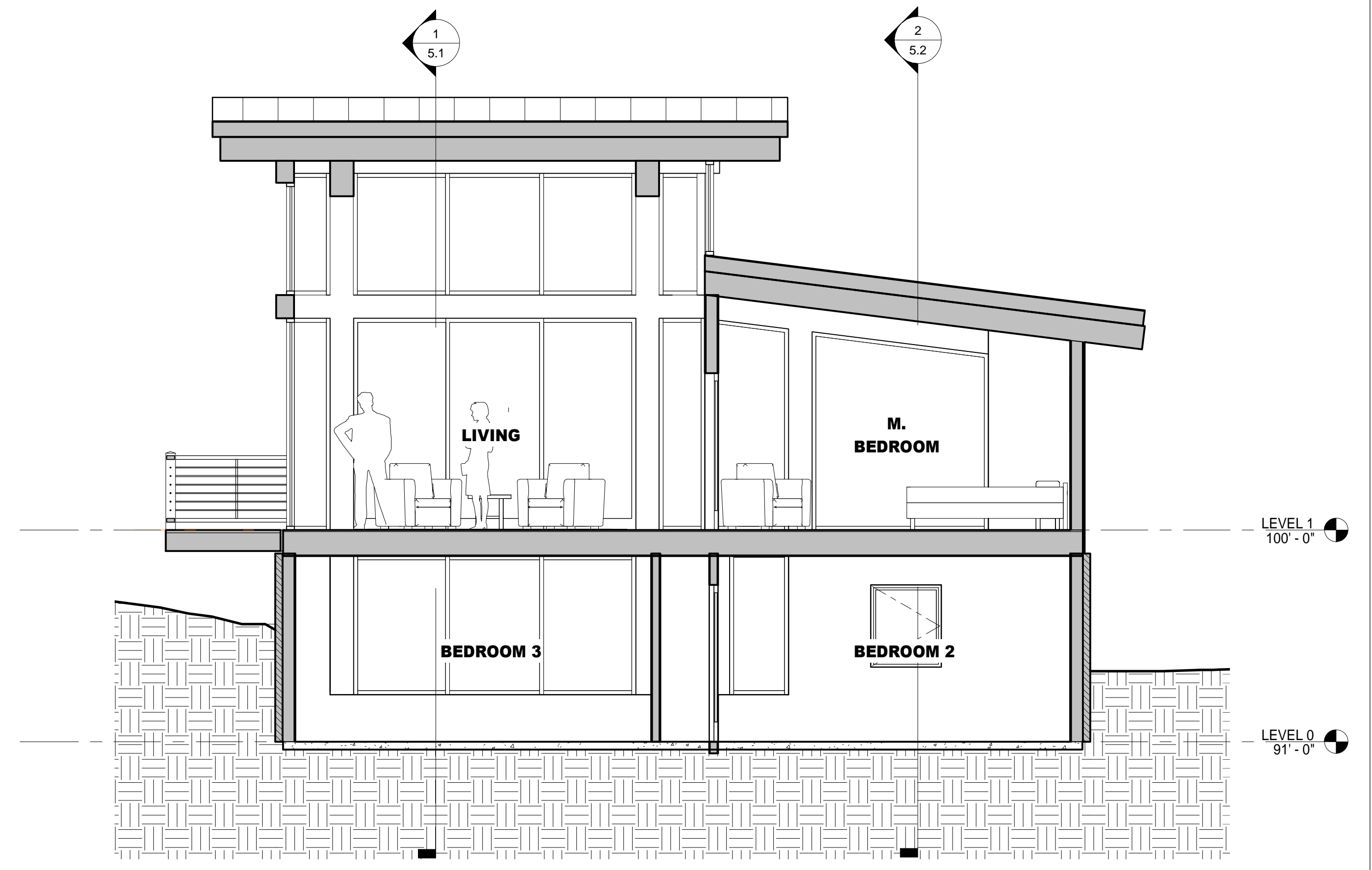

3 SECTION B
SCALE: 1/4" = 1'-0"

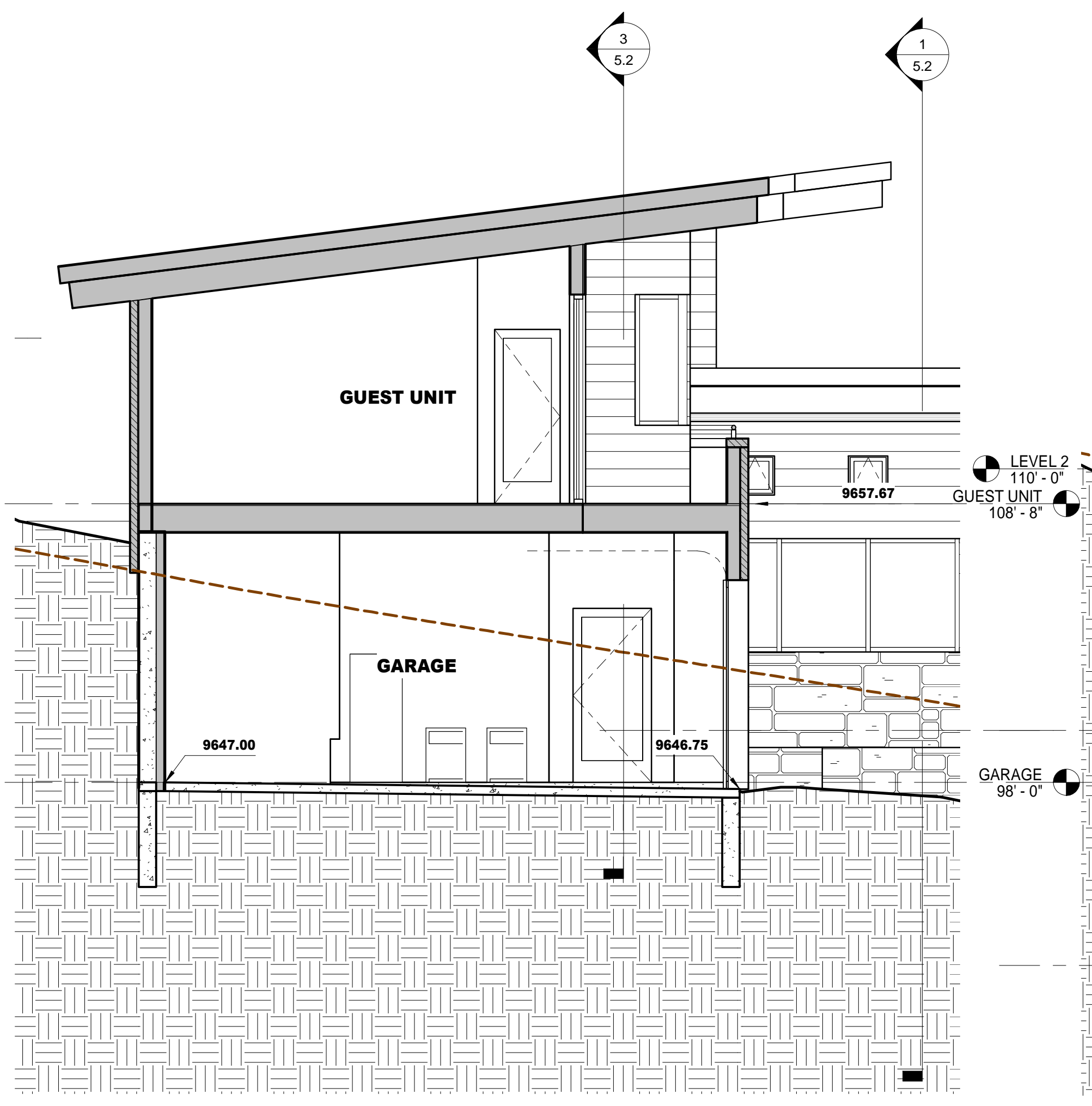

2 GARAGE SECTION
SCALE: 1/4" = 1'-0"

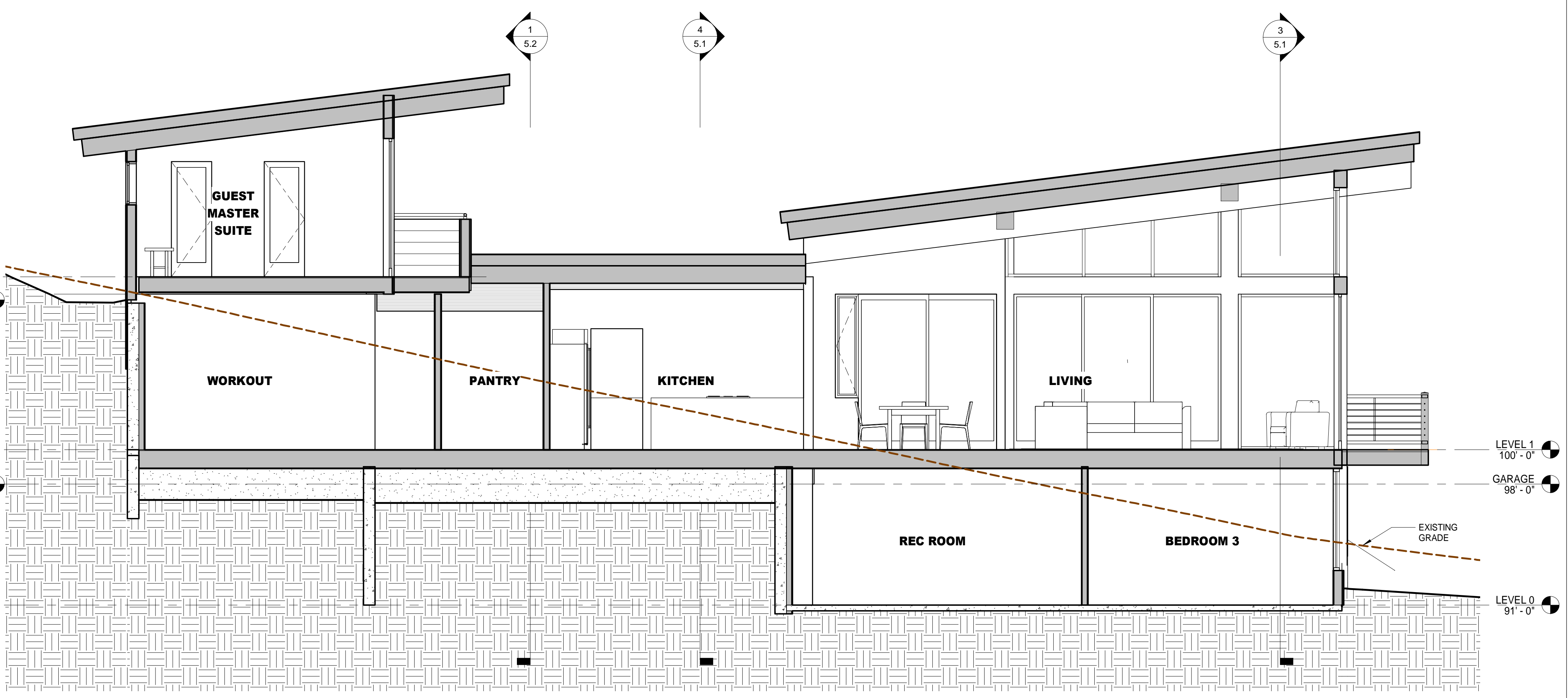

1 SECTION A
SCALE: 1/4" = 1'-0"

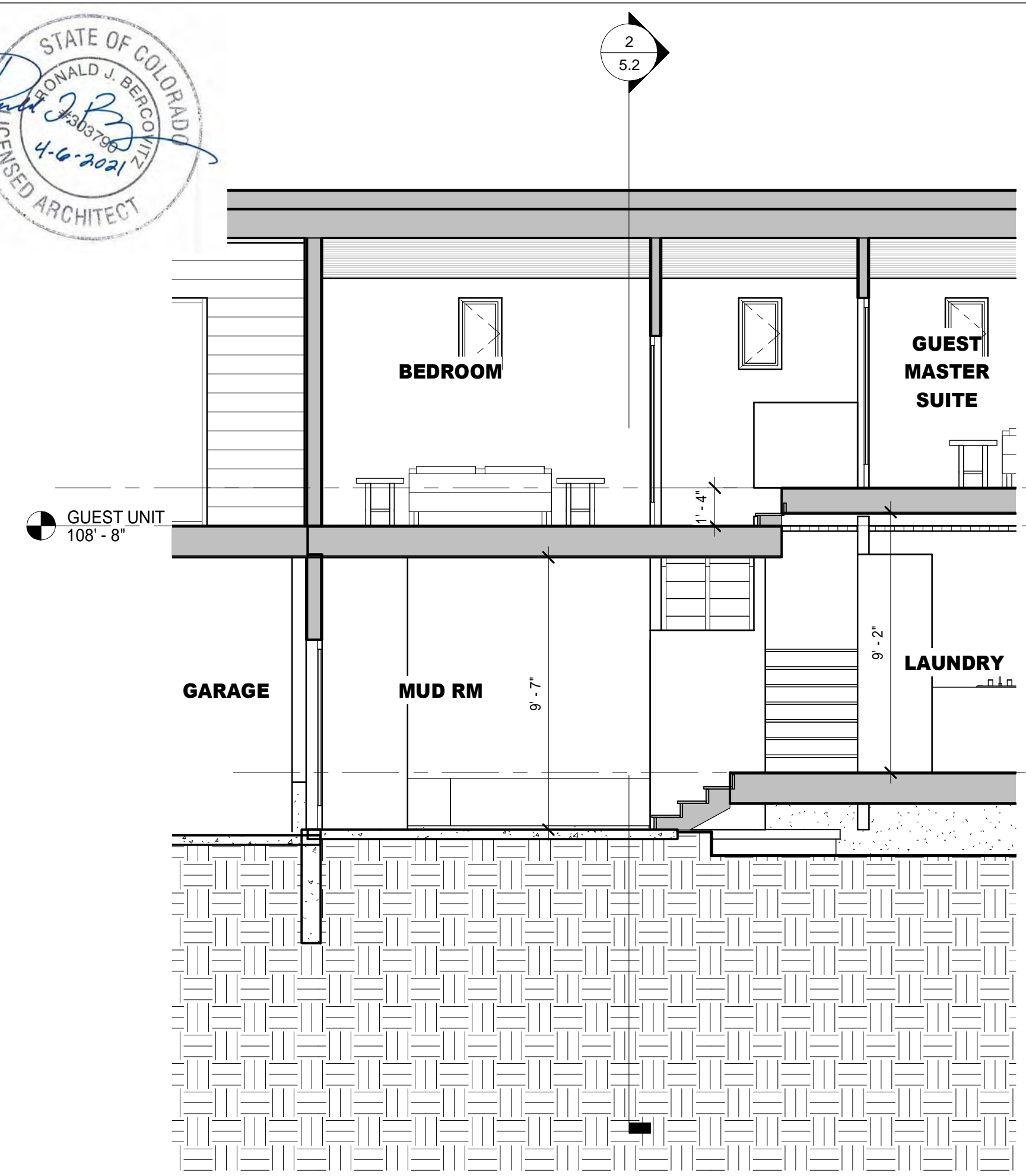

3 SECTION F
SCALE: 1/4" = 1'-0"

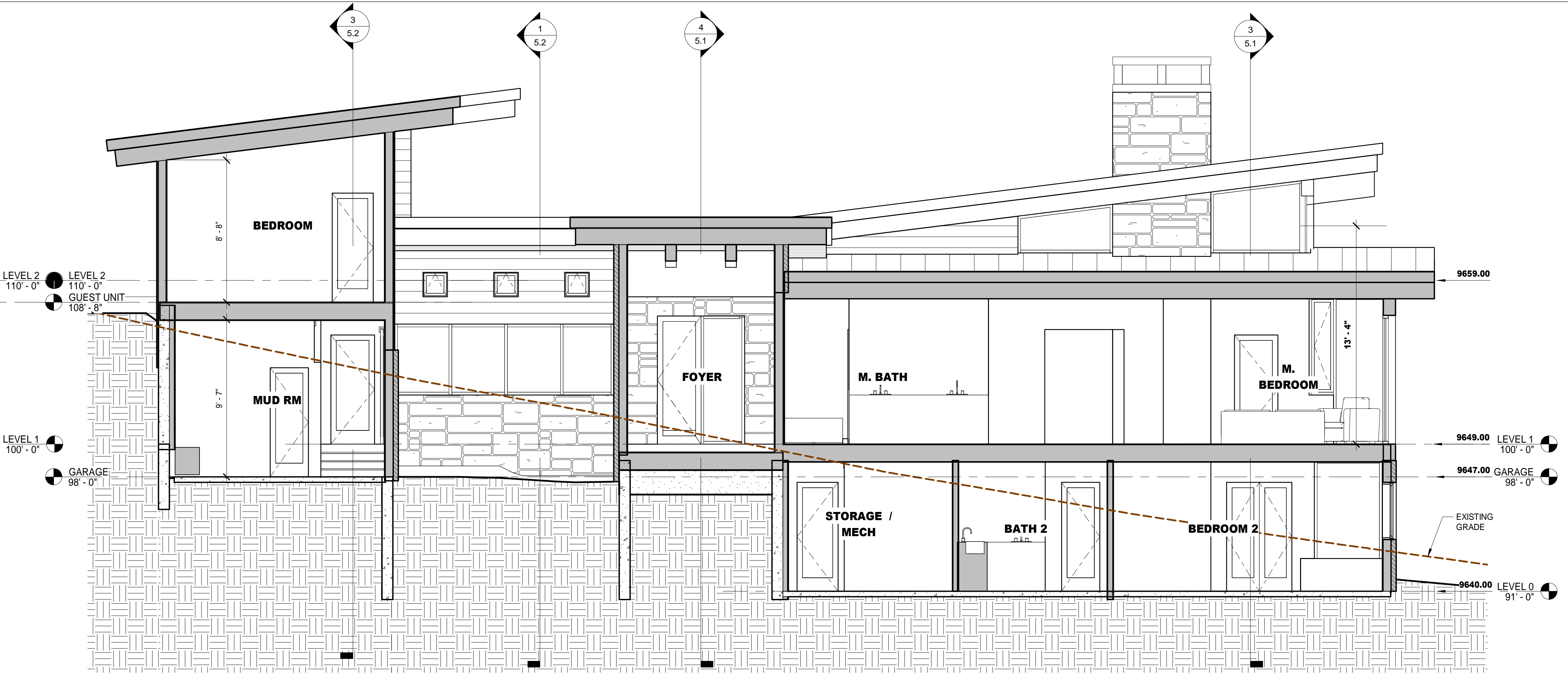

2 SECTION D
SCALE: 1/4" = 1'-0"



1 SECTION E
SCALE: 1/4" = 1'-0"

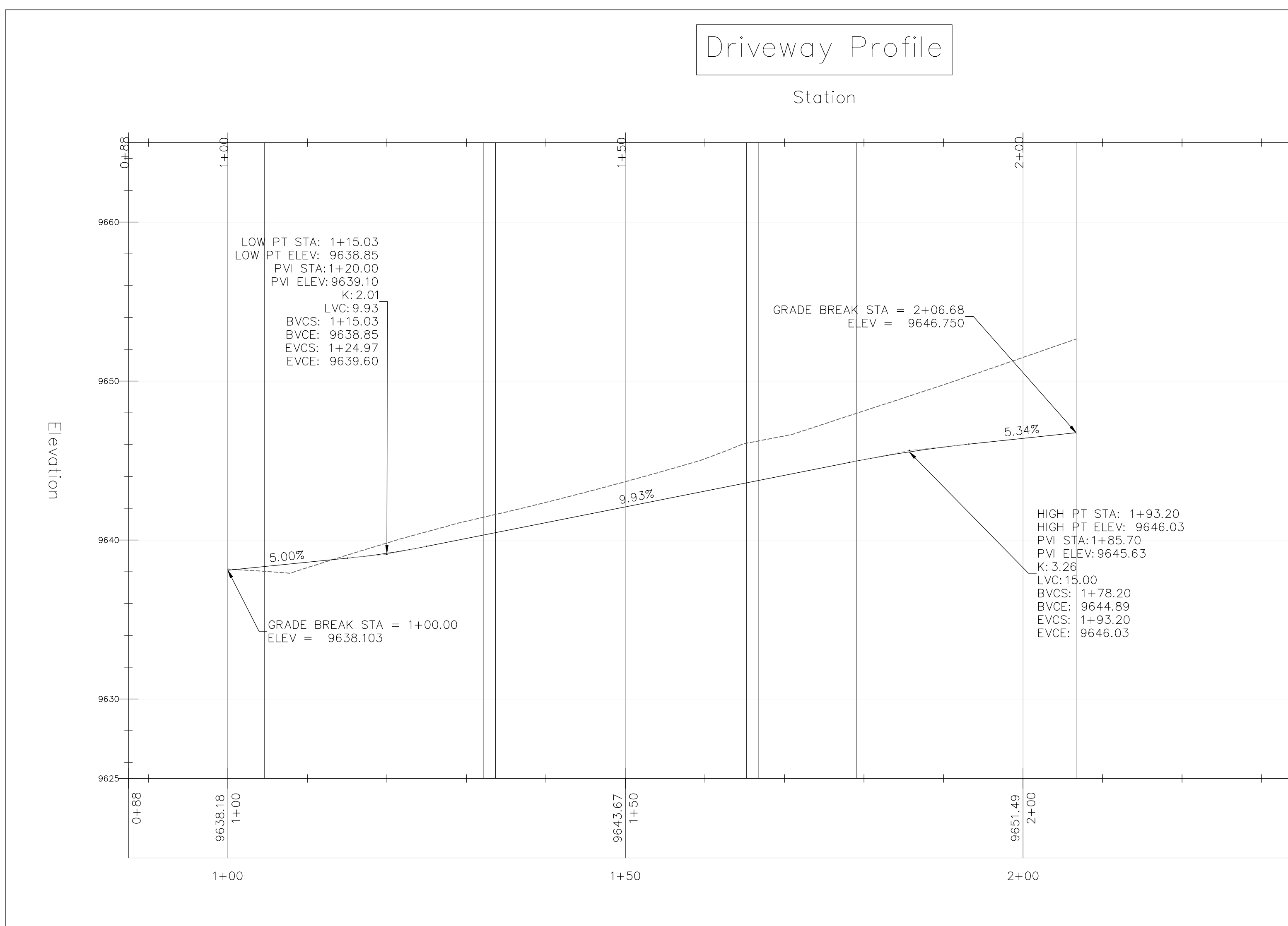
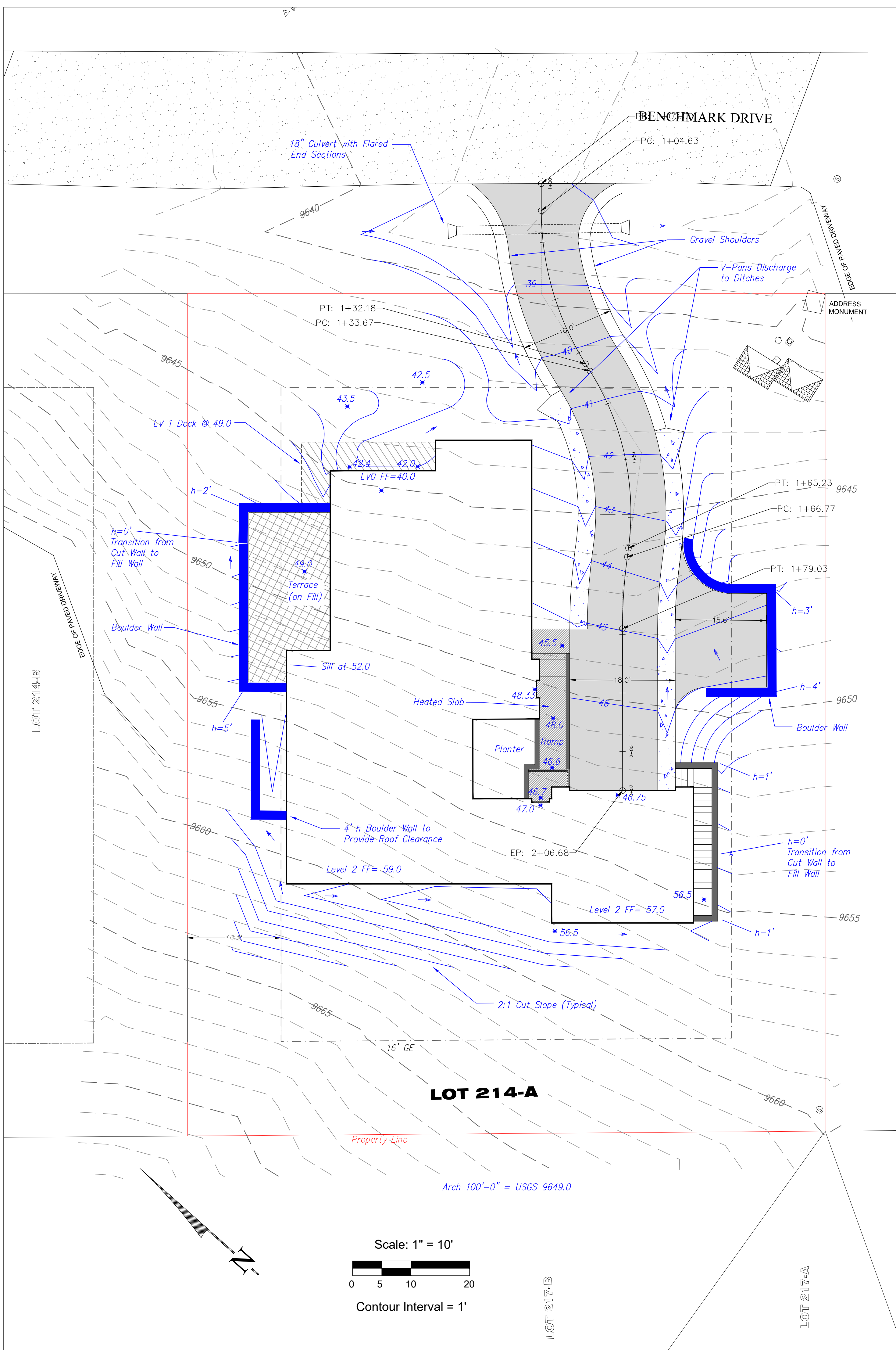

Uncompahgre Engineering, LLC
 P.O. Box 3945
 Telluride, CO 81435
 970-729-0683

SUBMISSIONS:
 SUBMITTAL 2021-04-05

Lot 214 A
 Benchmark
 Mtn. Village, CO



CONTRACTOR TO REVIEW AND COMPARE ALL CHAPTERS AND INTERDISCIPLINARY DRAWINGS AND REPORT ANY DISCREPANCIES TO THE ARCHITECT PRIOR TO ANY FIELD WORK BEING DONE IN ACCORDANCE WITH AIA DOCUMENT A201

Civil Site Grading and Drainage with Driveway Profile

C2

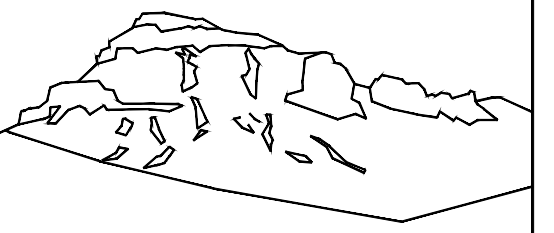

Uncompahgre
Engineering, LLC

P.O. Box 3945
Telluride, CO 81435
970-729-0683

SUBMISSIONS:
SUBMITTAL 2021-04-05

Lot 214 A
Benchmark
Mtn. Village, CO



CONTRACTOR TO REVIEW AND COMPARE ALL
CHAPTERS AND INTERDISCIPLINARY DRAWINGS
AND REPORT ANY DISCREPANCIES TO THE
ARCHITECT PRIOR TO ANY FIELD WORK BEING
DONE IN ACCORDANCE WITH AIA DOCUMENT A201

Utilities

C3

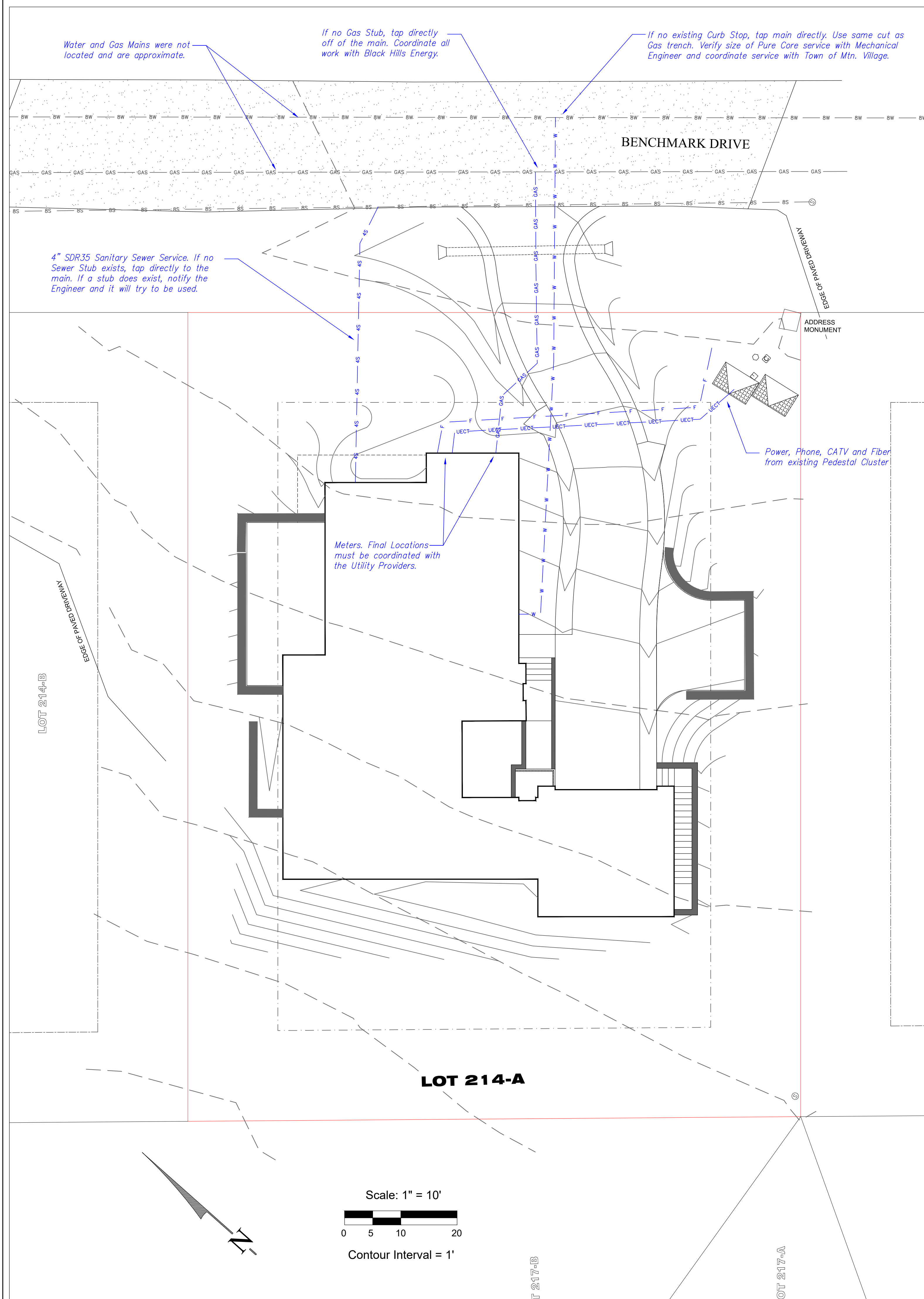

GENERAL CIVIL ENGINEERING NOTES:

1. THE EXISTING UTILITY LINES SHOWN ON THE PLANS ARE APPROXIMATE. AT LEAST TWO (2) FULL WORKING DAYS PRIOR TO COMMENCING CONSTRUCTION, THE CONTRACTOR SHALL CONTACT THE UTILITY NOTIFICATION CENTER OF COLORADO @ 1-800-922-1987 OR 811 TO GET ALL UTILITIES LOCATED. IF ANY OF THESE UNDERGROUND UTILITIES ARE IN CONFLICT WITH THE CONSTRUCTION PLANS, THE CONTRACTOR SHALL NOTIFY THE ENGINEER AND WORK WITH THE ENGINEER TO FIND A SOLUTION BEFORE THE START OF CONSTRUCTION.

INSTALLATION AND SEPARATION REQUIREMENTS SHALL BE COORDINATED WITH THE INDIVIDUAL UTILITY PROVIDERS.

THE UTILITY PROVIDERS ARE:
SEWER, WATER, CABLE TV AND FIBEROPTIC: TOWN OF MOUNTAIN VILLAGE
NATURAL GAS: BLACK HILLS ENERGY
POWER: SAN MIGUEL POWER
TELEPHONE: CENTURY LINK

2. PRIOR TO BEGINNING ANY CONSTRUCTION ACTIVITIES, ALL NECESSARY PERMITS SHALL BE OBTAINED BY THE OWNER OR CONTRACTOR.

3. IT IS THE CONTRACTOR'S RESPONSIBILITY TO INSURE THAT EXCAVATED SLOPES ARE SAFE AND COMPLY WITH OSHA REQUIREMENTS. REFER TO THE SITE-SPECIFIC REPORT FOR THIS PROJECT FOR ADDITIONAL INFORMATION..

4. ALL TRENCHES SHALL BE ADEQUATELY SUPPORTED OR LAID BACK PER OSHA REGULATIONS.

5. ALL MATERIALS AND CONSTRUCTION SHALL BE IN CONFORMANCE WITH THE TOWN OF MOUNTAIN VILLAGE DESIGN STANDARDS LATEST EDITION. ALL CONSTRUCTION WITHIN EXISTING STREET OR ALLEY RIGHT-OF-WAY SHALL BE SUBJECT TO TOWN OF MOUNTAIN VILLAGE INSPECTION.

6. THE CONTRACTOR SHALL HAVE ONE COPY OF THE STAMPED PLANS ON THE JOB SITE AT ALL TIMES.

7. THE CONTRACTOR SHALL NOTIFY THE TOWN 48 HOURS PRIOR TO THE START OF CONSTRUCTION.

8. THE CONTRACTOR IS RESPONSIBLE FOR IMPLEMENTING AND MAINTAINING EROSION AND SEDIMENT CONTROL MEASURES AT ALL TIMES DURING CONSTRUCTION. THE ADJOINING ROADWAYS SHALL BE FREE OF DEBRIS AT THE END OF CONSTRUCTION ACTIVITIES EACH DAY.

9. THE CONTRACTOR SHALL PROVIDE, ERECT AND MAINTAIN PROPER TRAFFIC CONTROL DEVICES UNTIL THE SITE IS OPEN TO TRAFFIC. ANY TRAFFIC CLOSURES MUST BE COORDINATED WITH THE TOWN OF MOUNTAIN VILLAGE.

10. ALL DAMAGE TO PUBLIC STREETS AND ROADS, INCLUDING HAUL ROUTES, TRAILS, OR STREET IMPROVEMENTS, OR TO PRIVATE PROPERTY, SHALL BE REPAIRED AT THE SOLE EXPENSE OF THE CONTRACTOR TO THE ORIGINAL CONDITIONS.

11. WHEN AN EXISTING ASPHALT STREET IS CUT, THE STREET MUST BE RESTORED TO A CONDITION EQUAL TO OR BETTER THAN ITS ORIGINAL CONDITION. THE FINISHED PATCH SHALL BLEND SMOOTHLY INTO THE EXISTING SURFACE. ALL LARGE PATCHES SHALL BE PAVED WITH AN ASPHALT LAY-DOWN MACHINE.

12. IF DEWATERING IS REQUIRED, THE CONTRACTOR SHALL NOTIFY THE ENGINEER. ANY DISCHARGE REQUIREMENTS SHALL BE COORDINATED WITH THE TOWN OF MOUNTAIN VILLAGE.

13. CONTRACTOR SHALL NOTIFY ALL RESIDENTS IN WRITING 24 HOURS PRIOR TO ANY SHUT-OFF IN SERVICE. THE NOTICES MUST HAVE CONTRACTOR'S PHONE NUMBER AND NAME OF CONTACT PERSON, AND EMERGENCY PHONE NUMBER FOR AFTER HOURS CALLS. ALL SHUT-OFF'S MUST BE APPROVED BY THE TOWN AND TOWN VALVES AND APPURTENANCES SHALL BE OPERATED BY TOWN PERSONNEL.

14. CONTRACTOR SHALL KEEP SITE CLEAN AND LITTER FREE (INCLUDING CIGARETTE BUTTS) BY PROVIDING A CONSTRUCTION DEBRIS TRASH CONTAINER AND A BEAR-PROOF POLY-CART TRASH CONTAINER, WHICH IS TO BE LOCKED AT ALL TIMES.

15. CONTRACTOR MUST BE AWARE OF ALL TREES TO REMAIN PER THE DESIGN AND APPROVAL PROCESS AND PROTECT THEM ACCORDINGLY.

16. THE CONTRACTOR SHALL PROVIDE UNDERGROUND UTILITY AS-BUILTS TO THE TOWN.

17. ALL STRUCTURAL FILL UNDER HARDSCAPE OR ROADS MUST BE COMPACTED TO 95% MODIFIED PROCTOR (MIN.) AT PLUS OR MINUS 2% OF THE OPTIMUM MOISTURE CONTENT. NON-STRUCTURAL FILL SHALL BE PLACED AT 90% (MIN.) MODIFIED PROCTOR.

18. UNSUITABLE MATERIAL SHALL BE REMOVED AS REQUIRED BY THE SOILS ENGINEER. ALL MATERIALS SUCH AS LUMBER, LOGS, BRUSH, TOPSOIL OR ORGANIC MATERIALS OR RUBBISH SHALL BE REMOVED FROM ALL AREAS TO RECEIVE COMPACTED FILL.

19. NO MATERIAL SHALL BE COMPACTED WHEN FROZEN.

20. NATIVE TOPSOIL SHALL BE STOCKPILED TO THE EXTENT FEASIBLE ON THE SITE FOR USE ON AREAS TO BE REVEGETATED.

21. THE CONTRACTOR SHALL BE RESPONSIBLE FOR DUST ABATEMENT AND EROSION CONTROL MEASURES DEEMED NECESSARY BY THE TOWN, IF CONDITIONS WARRANT THEM.

22. ALL DISTURBED GROUND SHALL BE RE-SEEDED WITH A TOWN-APPROVED SEED MIX. REFER TO THE LANDSCAPE PLAN.

23. THE CONTRACTOR IS REQUIRED TO PROTECT ALL EXISTING SURVEY MONUMENTS AND PROPERTY CORNERS DURING GRADING AND CONSTRUCTION.

24. ALL UNDERGROUND PIPE SHALL BE PROTECTED WITH BEDDING TO PROTECT THE PIPE FROM BEING DAMAGED.

25. HOT TUBS SHALL DRAIN TO THE SANITARY SEWER (OR PUMPED TO AA CLEAN-OUT).

26. THE UTILITY PLAN DEPICTS FINAL UTILITY LOCATIONS BUT HAS BEEN COMPLETED AT A PRELIMINARY STAGE. CONTRACTOR SHALL VERIFY ALIGNMENTS WITH THE ARCHITECT PRIOR TO CONSTRUCTION.

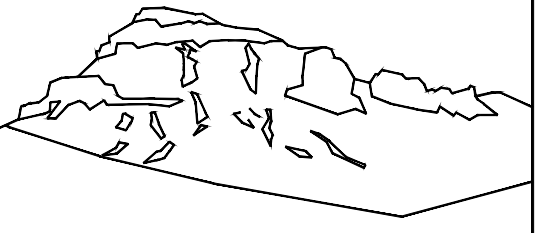

**Uncompahgre
Engineering, LLC**

**P.O. Box 3945
Telluride, CO 81435
970-729-0683**

SUBMISSIONS:

SUBMITTAL 2021-04-05

**Lot 214 A
Benchmark
Mtn. Village, CO**



CONTRACTOR TO REVIEW AND COMPARE ALL CHAPTERS AND INTERDISCIPLINARY DRAWINGS AND REPORT ANY DISCREPANCIES TO THE ARCHITECT PRIOR TO ANY FIELD WORK BEING DONE IN ACCORDANCE WITH AIA DOCUMENT A201

**Civil
Engineering**

General Notes

C1

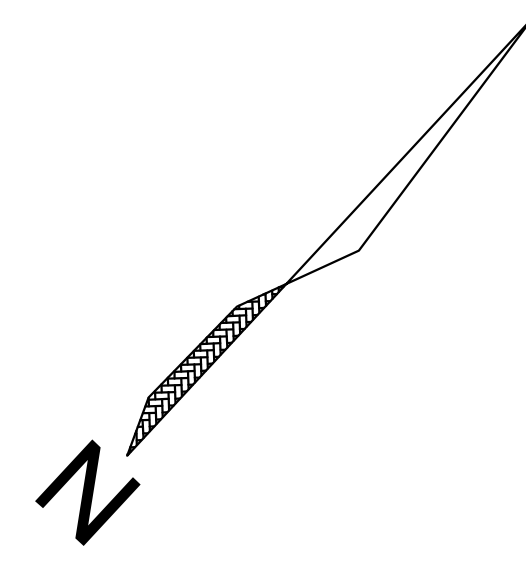

SCALE: 1" = 10'

CONTOUR INTERVAL=1'

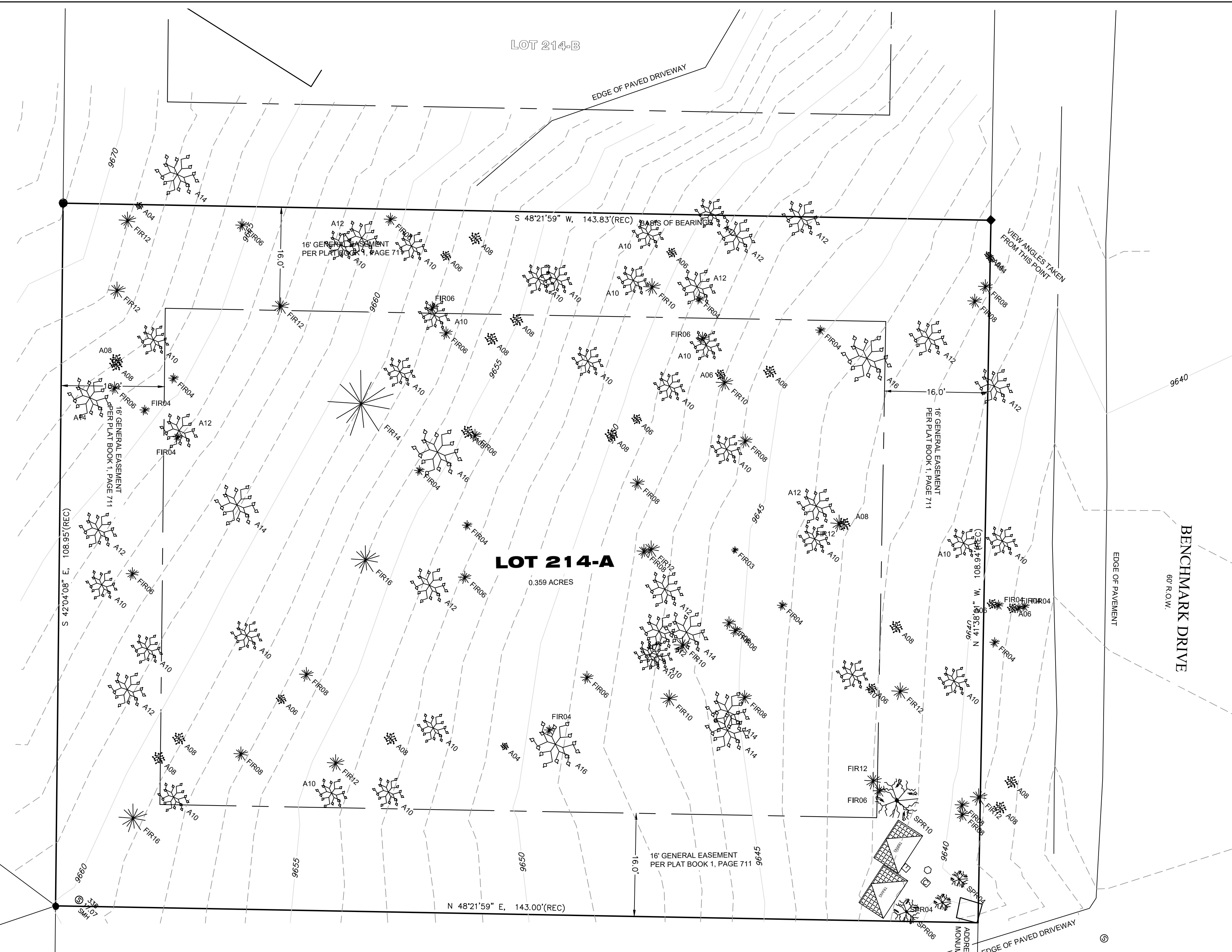

PROPERTY DESCRIPTION:

LOT 214-A, FILING 6, TELLURIDE MOUNTAIN VILLAGE, ACCORDING TO THE PLAT RECORDED IN PLAT BOOK 1, AT PAGE 711,
 COUNTY OF SAN MIGUEL,
 STATE OF COLORADO.

SURVEYOR'S CERTIFICATE:

I, Thomas A. Clark, being a Colorado Licensed Land Surveyor, do hereby certify that this Topographic Survey of Lot 214-A, Filing 6, Mountain Village was made by me and under my direct supervision, responsibility, and checking. This Topographic Survey does not constitute a Land Survey Plat or Improvement Survey Plat as defined by Title 38, Article 51 C.R.S.



Thomas A. Clark PLS. 38014

NOTES:

- This Topographic map does not constitute a title search by All Points Land Survey to determine easements of record of ownership.
- According to FEMA Flood Insurance Rate Map 008113C0300C Panel Number 0287 dated September 30, 1988 this parcel is within Zone X; Areas determined to be outside 500 year plain.
- Field work was performed in November 2020.
- Elevation datum for this survey is based on Global Positioning Systems (GPS) observation and OPUS solution (NAVD 88) benchmark "CP 9 OPUS" that elevation being 9639.94.
- This survey is valid only if a printed or electronic copy has a seal and signature of the surveyor noted within the statement above.
- NOTICE: According to Colorado law you must commence any legal action based upon defect in this survey within three years after you first discover such defect. In no event may any action based upon any defect in this survey be commenced more than ten years from the date of the certification shown hereon.
- Bearings for this topographic map are based on found monuments on the north line of Lot 214-A, as recorded in Plat Book 1, at Page 711
- No wetlands were observed on this property.

TREE CHART

- SPRUCE TREE WITH TRUNK DIAMETER INDICATED IN INCHES
- FIR TREE WITH TRUNK DIAMETER INDICATED IN INCHES
- ASPEN TREE WITH TRUNK DIAMETER INDICATED IN INCHES

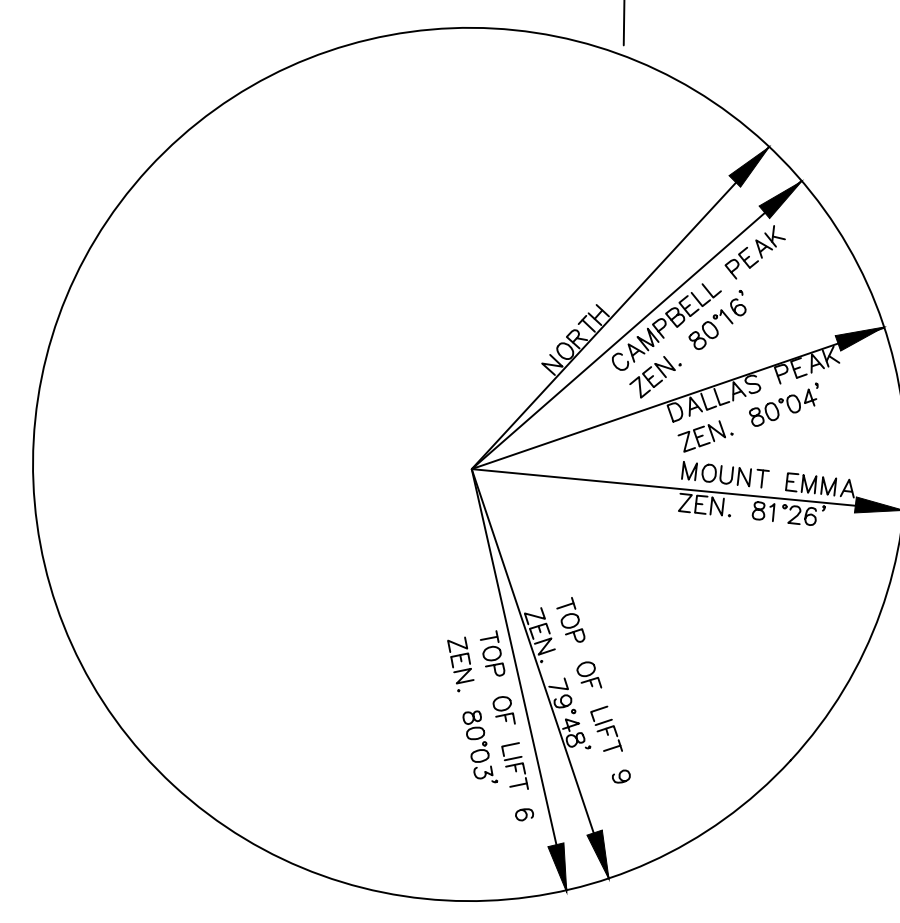

VIEW ANGLES
 ANGLES ENUMERATED
 ARE ZENITH ANGLES

LEGEND:

- FOUND #5 REBAR WITH 1 1/2" ALUMINUM CAP LS 37970
- FOUND #5 REBAR WITH 1 1/2" ALUMINUM NO ID NUMBER
- △ SURVEY CONTROL POINT
- FOUND #5 REBAR WITH 1 1/2" ALUMINUM CAP LS
- ⊞ TRANSFORMER
- TELEPHONE PEDESTAL
- ⊞ COMMUNICATIONS PEDESTAL
- ⊞ ELECTRIC METER
- ⊞ SANITARY SEWER MANHOLE

DATE: 04/01/2021	JCC	JOB# 20090
DRAWN BY TC	JCC	SHEET-1-OF-1
CHECKED BY JCC		

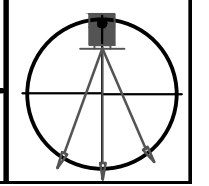

Craftsman™ Series - Small Batten

A field-seamed, snap-on batten roof system.

[CONCEALED FASTENING ROOF SYSTEMS >](#)

Home / Products / Roof / Concealed Fastening Roof Systems / Craftsman™ Series - Small Batten

Craftsman™ Series - Small Batten

The Craftsman™ Series is a snap-on batten roof system. The pan and batten are manufactured separately to maximize design flexibility and for ease of installation at difficult hip, valley and slope change conditions.

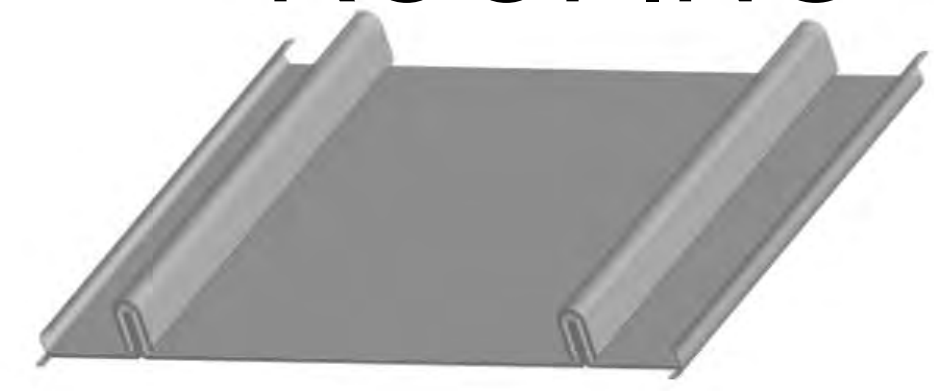

ROOFING

Burnished Slate Colors

Hover over a swatch to see a larger view

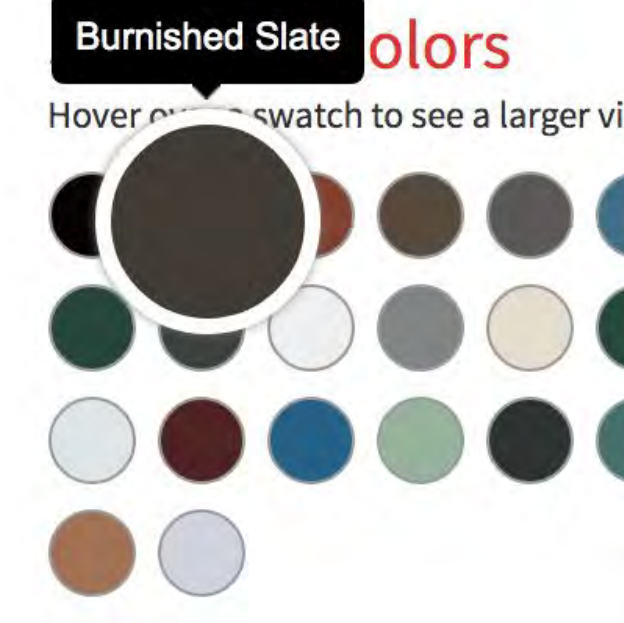

[View Color Charts >](#)



SIDING

A popular corrugated metal panel for horizontal architectural applications.

[EXPOSED FASTENING ROOF PANELS >](#)

Home / Products / Roof / Exposed Fastening Roof Panels / PBC

PBC

The PBC panels can be used for both roof and wall applications.



Burnished Slate Colors

Hover over a swatch to see a larger view



[View Color Charts](#)

STEEL SIDING

Product Information



- Features**
- Coverage Width - 32"
 - Minimum Slope - 3:12
 - Exposed Fastening System
 - Gauge - 26 (standard); 24, 22 (optional)
 - Finishes - Smooth (standard); Embossed (optional)
 - Coatings - Galvalume Plus®, Signature® 200, Signature® 300

[Related Applications](#)
Architectural Applications

 VistaLuxe® COLLECTION

AL LINE

WINDOWS



SIDING

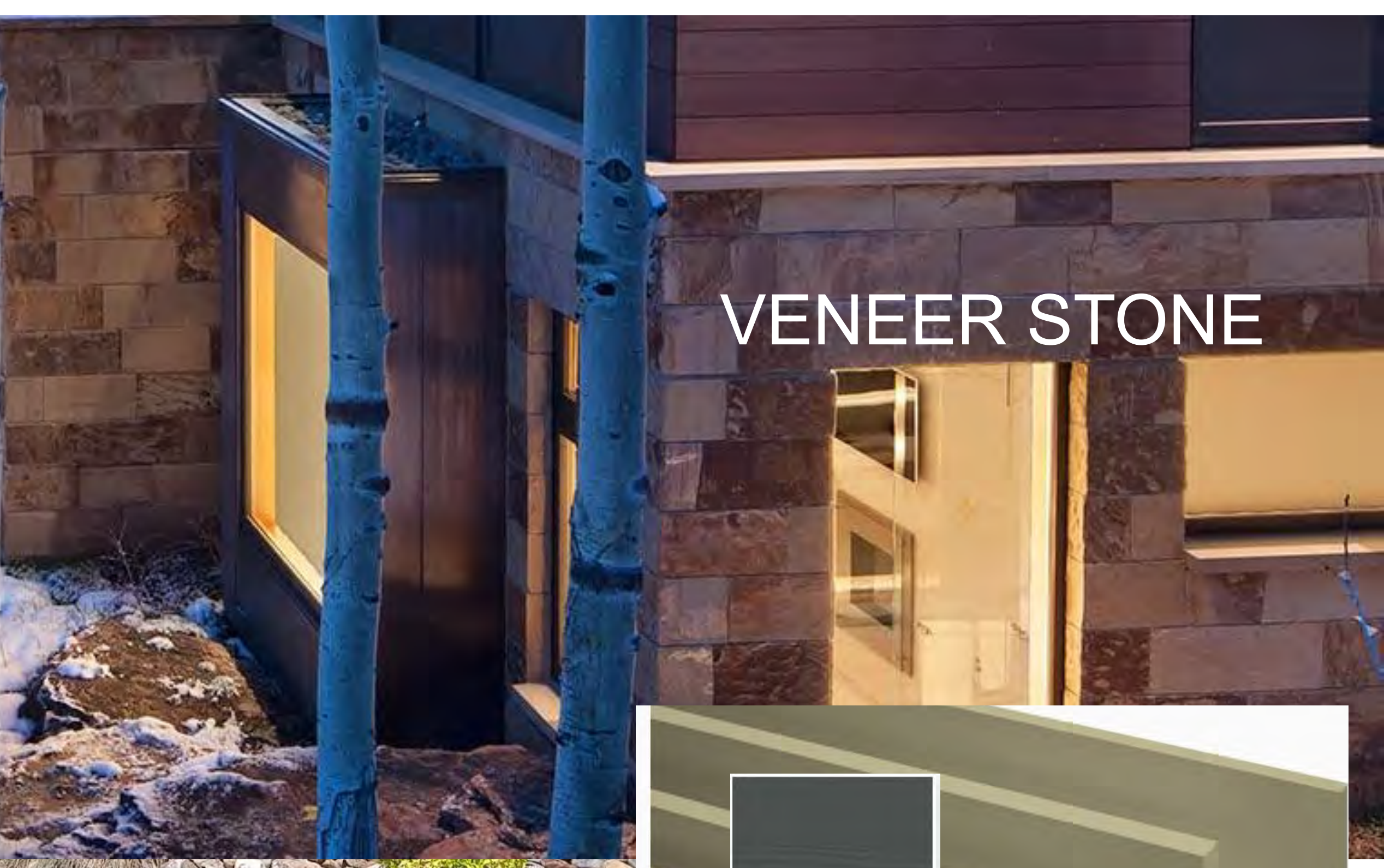

VENEER STONE



DRYSTACKED STONE



FASCIA

IRON GRAY

Hardie Trim®

LOT 214A HOUSE
TELLURIDE MOUNTAIN VILLAGE, COLORADO

BERCOVITZ DESIGN ARCHITECTS
201 W. Colorado Ave., Suite 205 TELLURIDE, CO 81435
(970) 728-4655

MATERIALS

4-6-2021 11:08:43 AM
MT.1

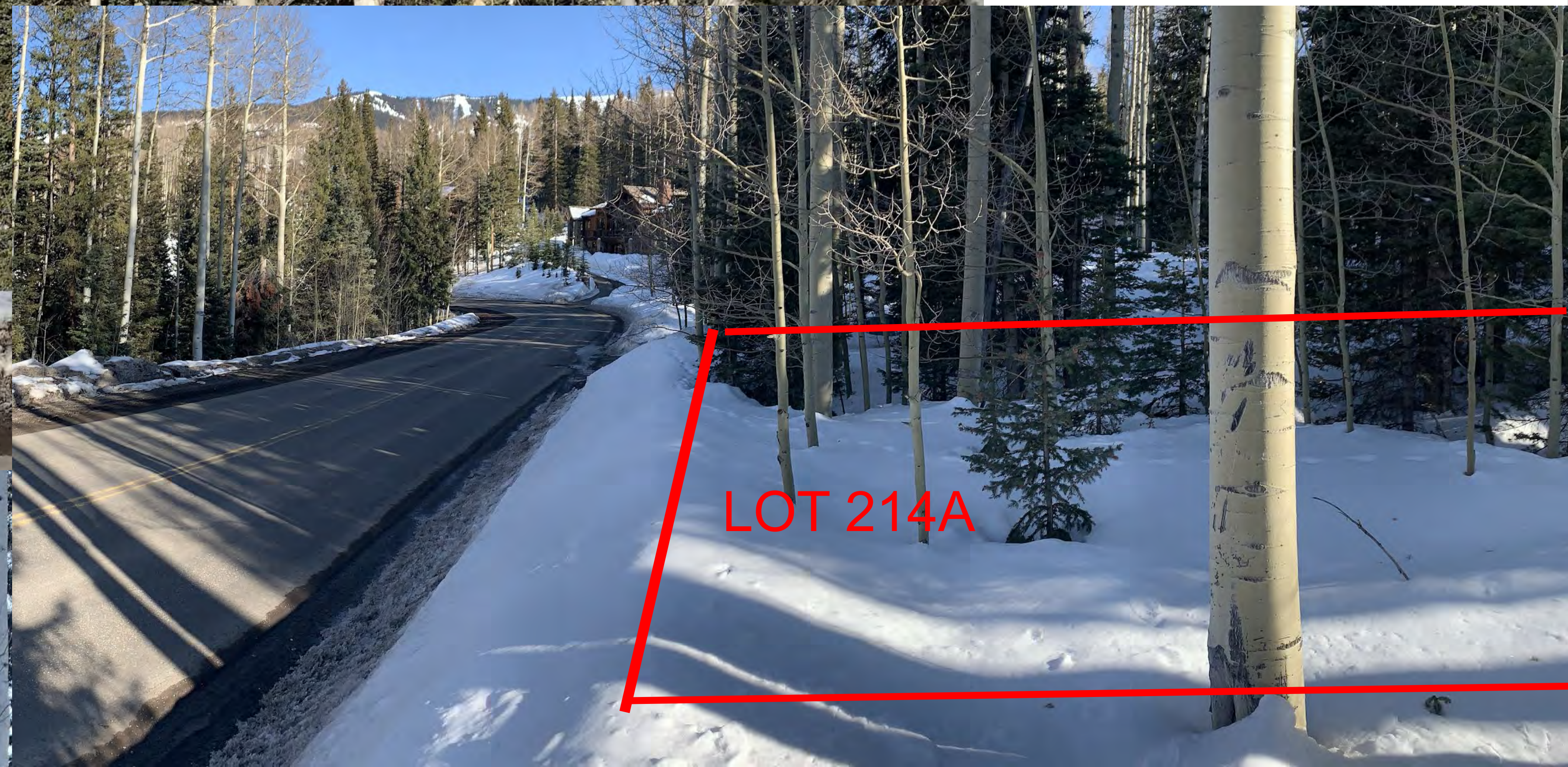

LOT 214-B

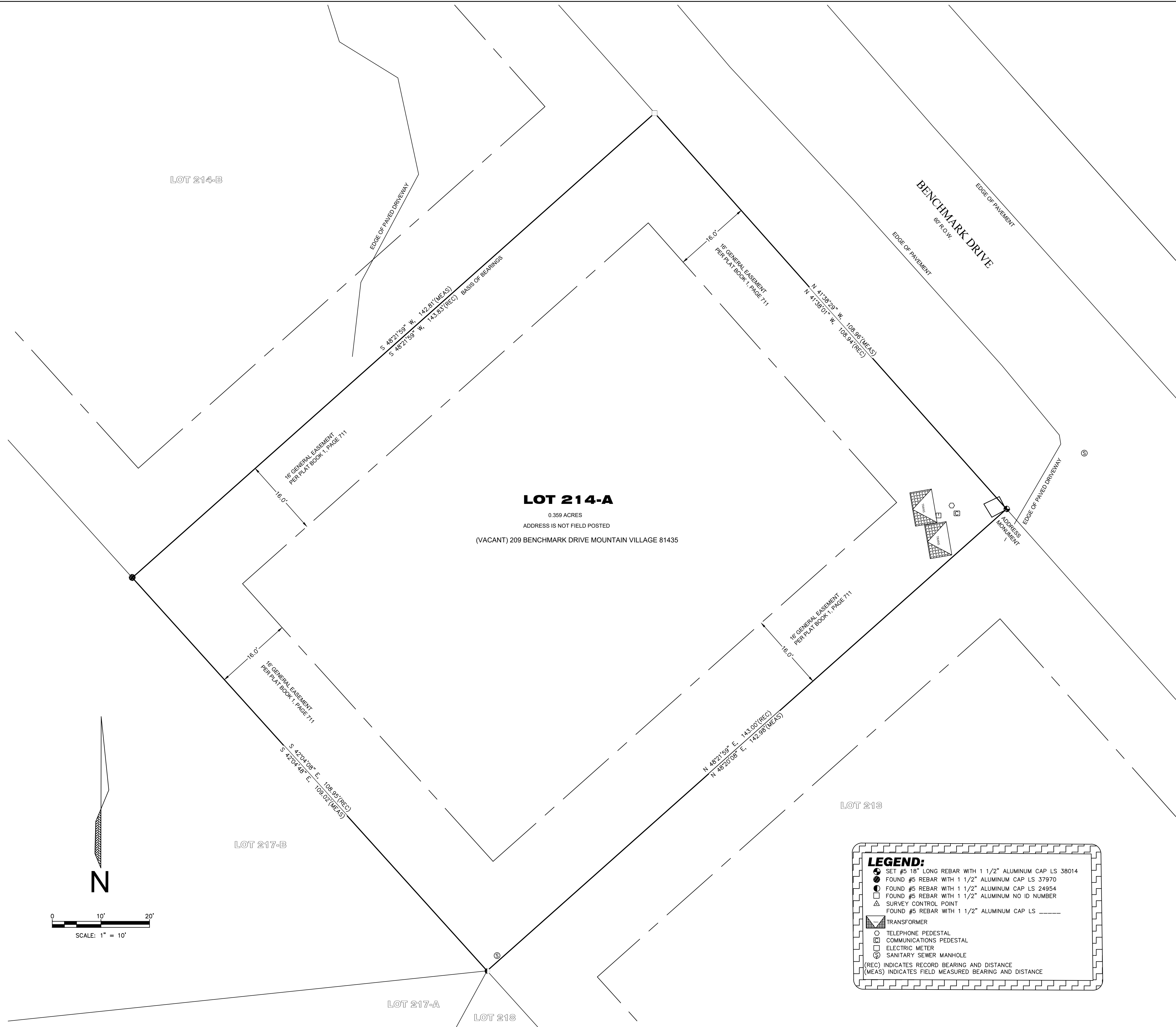

LOT 214-A
 0.359 ACRES
 ADDRESS IS NOT FIELD POSTED
 (VACANT) 209 BENCHMARK DRIVE MOUNTAIN VILLAGE 81435

PROPERTY DESCRIPTION:

LOT 214-A, FILING 6, TELLURIDE MOUNTAIN VILLAGE, ACCORDING TO THE PLAT RECORDED IN PLAT BOOK 1, AT PAGE 711,
 COUNTY OF SAN MIGUEL,
 STATE OF COLORADO.

LAND SURVEYORS CERTIFICATE:

I, Thomas A. Clark, being a Registered Land Surveyor in the State of Colorado, do hereby certify for and on behalf of All Points Land Survey, LLC, to Land Title Guarantee Company and KLURFELD FAMILY 2012 IRREVOCABLE TRUST that a survey of the premises of the parcel described hereon was made under my direct supervision, responsibility and checking on 5/26/2021, and that the information contained herein is true and accurate to the best of my knowledge and belief.

I further certify that the improvements on the above described parcel on this date, May 26, 2021, except utility connections, are entirely within the boundaries of the parcel, except as shown, that there are no encroachments upon the described premises by improvements on any adjoining premises, except as indicated and, there is no apparent evidence or sign of any easement crossing or burdening any part of said parcel, except as noted.



Thomas A. Clark PLS. 38014

NOTES:

- Easement research and property description provided by LAND TITLE GUARANTEE COMPANY - TELLURIDE, Order Number TLR66010794 effective on 10/28/2020 at 5:00 P.M.
- According to FEMA Flood Insurance Rate Map 008113C0300C Panel Number 0287 dated September 30, 1988 this parcel is within Zone X; Areas determined to be outside 500 year plain.
- Bearings for this survey are based on found monuments on the northern boundary of Lot 214 A Telluride Mountain Village Filing No. 6 Recorded on 3/24/1987 in Plat Book 1 at Page 708, as shown here on.
- Lineal units represented on this map are in U.S. Survey Feet or a decimal portion thereof.
- This survey is valid only if a printed or electronic copy has a seal and signature of the surveyor noted within the statement above.
- The word certify as used hereon means an expression of professional opinion regarding the facts of this survey and does not constitute a warranty or guarantee, expressed or implied.
- This survey is prepared for the exclusive use of the party or parties indicated within the surveyor's statement. Said statement does not extend to any unnamed person or parties without an expressed statement by the surveyor naming said entities.
- NOTICE: According to Colorado law you must commence any legal action based upon defect in this survey within three years after you first discover such defect. In no event may any action based upon any defect in this survey be commenced more than ten years from the date of the certification shown hereon.

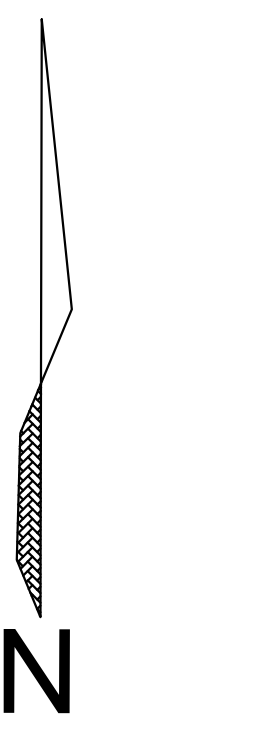

LEGEND:

- SET #5 18" LONG REBAR WITH 1 1/2" ALUMINUM CAP LS 38014
- FOUND #5 REBAR WITH 1 1/2" ALUMINUM CAP LS 37970
- FOUND #5 REBAR WITH 1 1/2" ALUMINUM CAP LS 24954
- FOUND #5 REBAR WITH 1 1/2" ALUMINUM NO ID NUMBER
- △ SURVEY CONTROL POINT
- FOUND #5 REBAR WITH 1 1/2" ALUMINUM CAP LS _____
- ⊠ TRANSFORMER
- TELEPHONE PEDESTAL
- COMMUNICATIONS PEDESTAL
- ELECTRIC METER
- ⊙ SANITARY SEWER MANHOLE
- (REC) INDICATES RECORD BEARING AND DISTANCE
- (MEAS) INDICATES FIELD MEASURED BEARING AND DISTANCE

RECORDER'S CERTIFICATE:

Deposited this _____ day of _____, 2021, at _____ m., in Book Number _____ of the _____ County, surveyor's land survey plats/right-of-way surveys at Page _____.

File number _____.

San Miguel County Clerk

IMPROVEMENT SURVEY PLAT FOR LOT 214-A, FILING 6, MOUNTAIN VILLAGE,
 SAN MIGUEL COUNTY, COLORADO. LOCATED IN SECTION 4, T42N, R9W, N.M.P.M.

ALL POINTS LAND SURVEY L.L.C.
 PO BOX 754 OPHIR, COLORADO 81435 (970) 708-9694

DATE: 5/26/2021	TC	JOB# 20090
DRAWN BY	JCC	SHEET-1-OF-1
CHECKED BY		

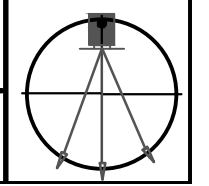



DEVELOPMENT REFERRAL FORM

Planning & Development Services
Planning Division
455 Mountain Village Blvd. Ste. A
Mountain Village, CO 81435
(970) 728-1392

Referral Agency Comments

Lot 214A, 209 Benchmark

Drive:

Hi Amy,

I have walked the General Easements of Lot 214A. I have determined that the G.E.'s between Lot 214A and Lot 213 and Lot 214A and Lot 217B will need to remain accessible for maintenance of the existing sewer main line. No plantings or landscaping should be allowed to take place in these GE's. As far as the encroachment with the driveway turnaround, if DRB wants to allow this, Public Works requests that it be recorded that any removal/damage to the turnaround will not be at the expense of the Town to repair/replace. The G.E. between lot 214A and 214B is not currently being used by the Town; encroachment of this G.E. is not an issue with Public Works. Please ask the applicant to field verify existing utilities and provide a utility plan that reflects this data.

Finn

Mike Otto - Diversity of tree plantings clause is not met. The type of shrub to be planted should be listed so that defensible space can be assured.

Scott Heidergott, Fire Marshall:

- 1) The structure is over 3,600 sq ft and shall require a monitored sprinkler system.
- 2) The width of the driveway shall meet the code of 16' total width. 12' shall be a hard surface with the shoulders meeting the same compaction required as the hard surface and shall be an all weather driving surface.
- 3) The address monument shall be minimum 4'6" from grade to the bottom of the address numbers. Address numbers shall be 6" in height, reflective coated or outlined with a reflective coating.
- 4) TFPD recommends the installation of a Knox Box for access during emergency situations



AGENDA ITEM 6
PLANNING & DEVELOPMENT SERVICE
PLANNING DIVISION
455 Mountain Village Blvd.
Mountain Village, CO 81435
(970) 728-1392

TO: Mountain Village Design Review Board
FROM: Amy Ward, Planner
FOR: Design Review Board Public Hearing; June 10, 2021
DATE: May 31, 2021
RE: Staff Memo – Initial Architecture and Site Review (IASR) Unit AR-52R, Timber Ridge, 123 Adams Way

APPLICATION OVERVIEW:

PROJECT GEOGRAPHY

Legal Description: UNIT AR-52R, TIMBER RIDGE AT MOUNTAIN VILLAGE (FORMERLY THE VILLAGE AT ADMAS RANCH), A COMMON INTEREST COMMUNITY, ACCORDING TO THE PLAT RECORDED OCTOBER 27, 2005 IN PLAT BOOK 1 AT PAGE 3561.

Address: 123 Adams Way

Applicant/Agent: Ken Alexander, Architects Collaborative

Owner: ADAM'S WAY, LLC A COLORADO LIMITED LIABILITY COMPANY

Zoning: Multi-family

Existing Use: Vacant

Proposed Use: Single Family Detached
Condominium

Lot Size: 0.127 acres

Adjacent Land Uses:

- **North:** Multi-family
- **South:** Open Space
- **East:** Multi-family
- **West:** Multi-Family

ATTACHMENTS

Exhibit A: Architectural Plan Set

Exhibit B: Staff/Public Comment



Case Summary: Peter Lundeen of Fuse Architects, Applicant for Unit AR-52R at Timber Ridge, is requesting Design Review Board (DRB) approval of an Initial Architectural and Site Review (IASR) Application for a new single-family detached condominium on Unit AR-52R, 123 Adams Way. The Unit is approximately .127 acres and is zoned Multi-family. The overall square footage of the home is approximately 3,970 gross square feet and provides 2 interior parking space within the proposed garage.

Applicable CDC Requirement Analysis: The applicable requirements cited may not be exhaustive or all-inclusive. The applicant is required to follow all requirements even if an applicable section of the CDC is not cited. **Please note that Staff comments will be indicated by *Italicized Text*.**

Table 1

CDC Provision	Requirement	Proposed
Maximum Building Height	35' (shed) Maximum	34' 11"
Maximum Avg. Building Height	30' (shed) Maximum	26.06'
Maximum Lot Coverage	65%	36.1%*
General Easement Setbacks	No encroachment	Grading
Roof Pitch		
Primary		2:12
Secondary		2:12
Exterior Material		
Stone	35% minimum	35%
Windows/Doors	40% maximum	24.4%
Parking	2 spaces per unit	2

* This number as presented doesn't include walkways, roof overhangs, eaves, exterior stairs, decks, covered porch, terraces and patios and also is based on an incorrect lot size and should be amended prior to final review.

DRB Specific Approval:

- 1) GE encroachment – grading

Chapter 17.3: ZONING AND LAND USE REGULATIONS

17.3.12: Building Height Limits

Sections 17.3.11 and 17.3.12 of the CDC provide the methods for measuring Building Height and Average Building Height, along with providing the height allowances for specific types of buildings based on their architectural form. The proposed design incorporates a combination of shed roof forms. Homes with a primary shed roof form are granted a maximum building height of 35 feet. The maximum average height must be at or below 30 feet for homes with a primary shed roof forms. The average height is an average of measurements from a point halfway between the roof ridge and eave. The points are generally every 20 feet around the roof. The maximum height is measured from the highest point on a roof directly down to the existing grade or finished grade, whichever is more restrictive.

Staff: Staff has determined that the primary roof form for this home is a shed and therefore granted a maximum height of 35 feet. The applicant has given a max height of 34' 11" and a max average height of 26.06' which appear to meet the requirements for both Maximum and Maximum Average heights and has provided a parallel plane analysis that also demonstrates such compliance.

17.3.14: General Easement Setbacks

Unit AR-52R is platted as a “Unit” within the Timber Ridge PUD. Each “Unit” is a designated building envelope, and the rest of the lot is designated as either Common Element (C.E) or Limited Common Element (L.C.E). The Timber Ridge Development does have a traditional 16’ GE surrounding the exterior boundary of the entire PUD. The CDC provides that the GE and other setbacks be maintained in a natural, undisturbed state to provide buffering to surrounding land uses. The CDC does provide for some development activity within the GE and setbacks such as Ski Access, Natural Landscaping, Utilities, Address Monuments, and Fire Mitigation. All encroachments not listed above will require encroachment agreements between the property owner and the Town.

Staff: The proposal includes several GE encroachments that fall into the above category of permitted GE development activity including the following:

- *Driveway: The Driveway as shown currently takes access from Adams Way and crosses the General Easement to the homesite.*
- *Utilities: Given Unit AR-52R’s location and the location of the existing utilities, the GE will need to be crossed on the eastern GE, accessing utilities within Adams Way.*
- *Landscaping: there are proposed new plantings within the GE and associated irrigation. The address monument appears to be in the LCE area.*

The proposal also includes some GE encroachments requiring specific DRB approval:

- *The applicant has some landscape grading in the western Common Element area as well as a very small area in the northern GE. Staff assumes that the grading in the Common Element is allowable as these plans were approved by the HOA.*

Chapter 17.5: DESIGN REGULATIONS

17.5.4: Town Design Theme

The Town of Mountain Village has established design themes aimed at creating a strong image and sense of place for the community. Due to the fragile high alpine environment, architecture and landscaping shall be respectful and responsive to the tradition of alpine design – reflecting elements of alpine regions while blending influences that visually tie the town to mountain buildings. The town recognizes that architecture will continue to evolve and create a regionally unique mountain vernacular, but these evolutions must continue to embrace nature and traditional style in a way that respects the design context of the neighborhoods surrounding the site.

Staff: The proposed design for Unit Ar-52 is very contemporary in form and can be categorized as the Mountain Modern Vernacular. Given its modern form, the home’s material palette of stone, wood, and metal needed to be strong enough to tie it to the existing homes in the Mountain Village while providing protection from the alpine environment.

In order to accomplish this, a square cut stone veneer covers much of the lower level. Dark metal roofing material will also be used as siding and provides a variation to the stone which is also a durable material for areas where snow loading might be an issue. The vertical wood siding of reclaimed barnwood nods to historic structures and provides some relief from the harder surfaces of stone and steel. Overall, it appears that the design is visually appealing and would fit within the existing Mountain Village Design Theme.

17.5.5: Building Siting Design

The CDC requires that any proposed development blend into the existing landforms and vegetation.

Staff: The proposed home does step down the lot with the natural landforms of the Unit. The roof form is a combination of shed roofs that help to break up the mass of the building and will present varied facades as the light shifts throughout the day. The central portion of the home has an interesting V-shaped form with opposing roof forms that also somewhat mimics the natural grade below. The site has a large existing boulder on the eastern side. Instead of removing it, the applicant has chosen to bring it into the design and will leave it in place next to an exterior deck, grading around it. Staff finds that the siting and overall building form of this home does a good job of blending into the existing landscape.

17.5.6: Building Design

The CDC requires that building form and exterior wall forms portray a mass that is thick and strong with a heavy grounded foundation.

Staff: The cut stone veneered base of this home, as well as the way it steps down the hillside presents a form that appears very grounded to the site. The building form to the right of the main entry, clad in metal, with no roof overhang also seems to visually anchor the home on the uphill side. The stone chimney, protruding through the shed roof brings the stone element up through the form, giving a sense of verticality. The large unbroken expanse of the stone on the south elevation of the garage acts as an anchor to the subsidiary metal clad form on top.

The windows and doors are specified to have the appropriate recess in stone clad areas, this “punch out” effect will also serve to enhance the feeling of thick and heavy wall forms.

17.5.7: Grading and Drainage Design

Staff: With the home and driveway covering most of the buildable area of the site, grading is used primarily to create positive drainage away from the home. The applicant has proposed some grading in on the northwest corner of the home that extends into the GE. There is a drainage swale that wraps around the front of the home, the applicant should provide more detail about the finish of this swale- whether it is to be lined with rock or just graded and revegetated.

17.5.8: Parking Regulations

Staff: The CDC requires all single-family common interest developments to provide two parking spaces. The applicant has shown two interior spaces in the enclosed garage that meet the required sizes of 9' x 18'. Additionally, they have proposed a hammerhead in the driveway which appears to meet the CDC requirements of the Parking Area Design Standards, Garage Back-Out, which requires garages that are designed to have cars backing out have a minimum of 25 feet of backup space.

17.5.9: Landscaping Regulations

The applicant has provided a landscaping plan. It includes mostly aspen and spruce with the addition of some mugo pine and perennial beds. Irrigation is indicated and extends slightly into the GE. The appropriate seed mix has been indicated for revegetation. Staff would encourage the applicant to add a bit more diversity to the plan in the visible areas along Adams Way. The town forester has indicated that it doesn't currently meet the diversity of species clause.

17.5.11: Utilities

Staff: The utility plan indicates an existing gas service to be moved, it should be noted that this is at the expense of the applicant. Utility connections will run from existing boxes, under the drive to the south side of the garage. They appear to be on the south side of the garage in a fairly visually unobtrusive spot.

17.5.12: Lighting Regulations

Staff: The applicant has provided an exterior lighting plan; a photometric study was not provided. It should be noted that a lighting plan is not required until final review. The lighting plan shows a wall mounted sconce (EXT. 1) that does not have a full specification sheet. Because of this, it is difficult to determine if the fixture meets the CDC requirements. A full specification sheet as well as a photometric study should be provided for prior to final review.

17.5.13: Sign Regulations

Staff: The address marker is on the south side of the driveway within the LCE. Staff believes the location of the monument should be slightly adjusted to be viewed from both directions. It is unclear what the material is. The numerals, dimensions and lighting of the monument all appear to meet the requirements of the CDC.

Chapter 17.6: SUPPLEMENTARY REGULATIONS

17.6.1: Environmental Regulations

Staff: Fire Mitigation and Forestry Management: The applicant has submitted a fire mitigation plan that appears to meet the regulations of the CDC.

17.6.6: Roads and Driveway Standards

Staff: The driveway is approximately 40' long and proposed at a width of 12' plus 2' shoulders. The grade is 4.5-5%. It does provide the required garage back out space. The retaining walls on either side of the drive are under the 4' maximum allowable.

17.6.8: Solid Fuel Burning Device Regulations

Staff: The applicant has indicated that the proposed home does include fireplaces and that they are to run on natural gas. Although the chimney appears capped in the elevations, more detail should be provided about the materials and design of such.

Chapter 17.7: BUILDING REGULATIONS

17.7.19: Construction Mitigation

Staff: The construction mitigation plan shows required material staging, dumpster, bear-proof trash receptacles, parking and a port a toilet. The construction fencing seems adequate as presented. Silt fencing has been included. The parking outside of the driveway area will probably be accessed through the GE and create additional disturbance, but the applicant has indicated appropriate repair and revegetation on his plan utilizing the grass seed mix specified in the landscape regulations. There are some trees fairly close to the home that are slated to be kept, the applicant should include a detail of tree protection methods. With extensive excavation proposed on a small lot, the plan should also include information pertaining to stockpiled material locations and/or a removal plan. The applicant should revise the CMP prior to final review. No crane is indicated on the CMP, if it is determined that one is required, the applicant shall work with town staff to make sure the crane swing doesn't impede the roadway.

Staff Recommendation: Staff recommends the DRB approve the Initial Architectural and Site Review for Unit AR-52R Timber Ridge, 123 Adams Way, based on the findings and CDC requirements listed in the staff memo of record.

Staff Note: *It should be noted that reasons for approval or rejection should be stated in the findings of fact and motion.*

Proposed Motion:

If the DRB deems this application to be appropriate for approval, Staff requests said approval condition the items listed below in the suggested motion.

I move to approve the Initial Architectural and Site Review for a new detached condominium located at Unit AR-52R Timber Ridge, based on the evidence provided within the Staff Report of record dated May 31, 2021, with the following specific approvals:

DRB Specific Approval:

- 1) GE encroachment for grading

And, with the following conditions:

- 1) Prior to final review, the applicant shall modify the landscaping plan to include additional tree plants to increase variety of species.
- 2) Prior to final review, the applicant shall revise the construction mitigation plan to include tree protection and material stockpile storage areas and/or removal plan.
- 3) Prior to final review, the applicant will give additional lighting specifications that verify that all fixtures meet the lighting requirements of the CDC and shall provide a photometric study.
- 4) Prior to final review, the applicant will revise the monument location to be better seen from either direction and will specify monument materials.
- 5) Prior to final review, the applicant shall revise the drainage plan to include details about the swale to the east of the home.
- 6) Consistent with town building codes, Unenclosed accessory structures attached to buildings with habitable spaces and projections, such as decks, shall be constructed as either non-combustible, heavy timber or exterior grade ignition resistant materials such as those listed as WUIC (Wildland Urban Interface Code) approved products.
- 7) A monumented land survey shall be prepared by a Colorado public land surveyor to establish the maximum building height and the maximum average building height.
- 8) A monumented land survey of the footers will be provided prior to pouring concrete to determine there are no additional encroachments into the GE.
- 9) Prior to the Building Division conducting the required framing inspection, a four-foot (4') by eight-foot (8') materials board will be erected on site consistent with the review authority approval to show:
 - a. The stone, setting pattern and any grouting with the minimum size of four feet (4') by four feet (4');
 - b. Wood that is stained in the approved color(s);
 - c. Any approved metal exterior material;
 - d. Roofing material(s); and
 - e. Any other approved exterior materials
- 10) It is incumbent upon an owner to understand whether above grade utilities and town infrastructure (fire hydrants, electric utility boxes) whether placed in the right

of way or general easement, are placed in an area that may encumber access to their lot. Relocation of such above grade infrastructure appurtenances will occur at the owner's sole expense and in coordination with the appropriate entity (fire department, SMPA, Town of Mountain Village) so that the relocated position is satisfactory.

/aw

GENERAL NOTES

- THE CONTRACT DOCUMENTS INCLUDE THE CONTRACTUAL AGREEMENT, THE DRAWINGS, & THE PROJECT MANUAL (SPECIFICATIONS, SUPPLEMENTAL DRAWINGS, ADDENDA & PRODUCT CUT SHEETS).
- ALL REQUIRED WORK SHALL BE PERFORMED BY THE GENERAL CONTRACTOR, UNLESS OTHERWISE NOTED. ALL REFERENCES TO THE CONTRACTOR INCLUDE THE GENERAL CONTRACTOR AND HIS SUBCONTRACTORS; THEY SHALL BE ONE AND THE SAME.
- THE CONTRACTOR SHALL OBTAIN ALL APPLICABLE BUILDING PERMITS, ALL NECESSARY INSPECTIONS, & THE CERTIFICATE OF OCCUPANCY.
- THE CONTRACTOR IS RESPONSIBLE FOR THE CONFORMANCE OF ALL WORK TO ANY AND ALL APPLICABLE BUILDING CODES (INCLUDING PLUMBING AND ELECTRICAL). ANY DISCREPANCIES OR NONCONFORMING ITEMS FOUND IN THE DRAWINGS MUST BE IMMEDIATELY BROUGHT TO THE ATTENTION OF THE ARCHITECT.
- IMMEDIATELY FOLLOWING THE AWARDING OF THE CONTRACT, THE CONTRACTOR SHALL SUBMIT A CONSTRUCTION SCHEDULE. ANY AND ALL CHANGES OR SUBMITTALS AFFECTING CONSTRUCTION COST OR SCHEDULE SHALL BE SUBMITTED TO THE ARCHITECT FOR APPROVAL. ANY DISCREPANCIES OR NONCONFORMING ITEMS FOUND IN THE DRAWINGS MUST BE IMMEDIATELY BROUGHT TO THE ATTENTION OF THE ARCHITECT.
- THE CONTRACTOR IS RESPONSIBLE FOR SUBMITTING TO THE ARCHITECT ALL SHOP DRAWINGS AND FINISH MATERIAL SAMPLES ALLOWING ADEQUATE TIME FOR REVIEW, APPROVAL OR CORRECTIONS SO AS NOT TO ADVERSELY AFFECT THE CONSTRUCTION SCHEDULE.
- THE CONTRACTOR SHALL COORDINATE ALL WORK PERFORMED BY THE VARIOUS SUB-CONTRACTORS, AND SHALL VERIFY AND COORDINATE ALL OPENINGS THROUGH FLOORS, WALLS AND CEILINGS WITH ARCHITECTURAL, STRUCTURAL, MECHANICAL & ELECTRICAL DRAWINGS.
- THE CONTRACTOR IS RESPONSIBLE FOR THE PROTECTION OF ALL MATERIALS BEING DELIVERED TO THE PROJECT, THE PROTECTION OF NEIGHBORING PROPERTIES, AND THE COMPLIANCE TO ALL O.S.H.A. REQUIREMENTS.
- THE JOB SITE SHALL BE MAINTAINED IN A CLEAN, ORDERLY MANNER, FREE OF TRASH AND CONSTRUCTION DEBRIS. THE CONTRACTOR SHALL PROVIDE FOR RECYCLING AT THE JOBSITE.
- THE DRAWINGS SHOULD NOT BE SCALED, IF A DIMENSION CANT BE DETERMINED THE CONTRACTOR SHALL PROMPTLY CONTACT THE ARCHITECT FOR VERIFICATION.
- IT IS THE CONTRACTOR'S RESPONSIBILITY TO INSURE THAT INSTALLATION METHODS CONFORM TO ALL BUILDING CODE REQUIREMENTS. THE MATERIALS SPECIFIED ARE INTENDED TO MEET CODE REQUIREMENTS. ANY DISCREPANCY BETWEEN THE CONSTRUCTION DOCUMENTS AND CODE REQUIREMENTS SHALL BE BROUGHT TO THE ATTENTION OF THE ARCHITECT IMMEDIATELY BY THE CONTRACTOR PRIOR TO PROCEEDING WITH THE SPECIFIED WORK.
- ELECTRICAL SERVICE, WIRING, ETC. SHALL COMPLY WITH APPLICABLE ELECTRICAL CODES.
- PLUMBING SHALL COMPLY WITH APPLICABLE PLUMBING CODES.
- ALL MATERIALS PROVIDED SHALL CONFORM TO ALL LOCAL, CITY AND/OR COUNTY FIRE REGULATIONS, CERTIFICATES, OR APPROVED FIRE RETARDANT PROCESSING FLAME SPREAD RATINGS, ETC., SHALL BE OBTAINED WITHOUT SPECIFIC REQUEST AND SUBMITTED TO THE ARCHITECT.
- THE DRAWINGS AND SPECIFICATIONS ARE COMPLIMENTARY. WHAT IS REQUIRED BY ONE SHALL BE AS BINDING AS IF REQUIRED BY ALL. WHEN A CONFLICT OCCURS, THE SPECIFICATIONS SHALL HAVE PRECEDENCE.
- NO SUBSTITUTIONS OF SPECIFIED MATERIALS SHALL BE PERMITTED WITHOUT FIRST SUBMITTING SPECIFICATIONS, SAMPLES, AND COST IMPACT FOR ARCHITECT'S APPROVAL.
- THE CONTRACTOR SHALL COORDINATE HIS WORK WITH ALL OTHER TRADES ON THE PROJECT. ANY CHANGES OR DELAYS ARISING FROM CONFLICTS BETWEEN TRADES SHALL BE THE RESPONSIBILITY OF THE CONTRACTOR AT NO ADDITIONAL COST TO THE OWNER.
- AT THE TIME OF BID SUBMITTAL, THE CONTRACTOR SHALL ADVISE THE ARCHITECT (IN WRITING) OF ANY SPECIFIED MATERIALS OR EQUIPMENT WHICH ARE EITHER UNAVAILABLE, OUT OF THE BUDGET OR WILL CAUSE A DELAY IN THE CONSTRUCTION COMPLETION SCHEDULE.
- THE CONTRACTOR SHALL PROVIDE AND INSTALL ROUGH PLUMBING AND FINAL HOOK-UP FOR ALL SPECIFIED FIXTURES AND APPLIANCES, AND SHALL SUPPLY ALL SUCH FIXTURES AND APPLIANCES, UNLESS OTHERWISE NOTED.
- CONTRACTOR SHALL COORDINATE WITH ALL EQUIPMENT MANUFACTURERS FOR EQUIPMENT ROUGH-IN REQUIREMENTS.
- THE CONTRACTOR SHALL VERIFY REQUIRED LOCATIONS OF ALL NECESSARY ACCESS PANELS (IN PARTITIONS, FLOORS, OR CEILINGS) AND COORDINATE EXACT LOCATIONS WITH THE ARCHITECT PRIOR TO INSTALLATION. ALL ACCESS PANELS SHALL BE INSTALLED FLUSH WITH THE SURFACE IN WHICH THEY ARE INSTALLED WITH NO EXPOSED TRIM.
- THE CONTRACTOR SHALL SUPPLY AND INSTALL BLOCKING AND SUPPORTS IN PARTITIONS AND CEILINGS AS REQUIRED FOR INSTALLATION OF SPECIFIED EQUIPMENT, ACCESSORIES, CABINETS, FINISH MATERIALS, AND FIRE BLOCKING (SEE BELOW).
- THE CONTRACTOR SHALL BE RESPONSIBLE FOR SUPPLYING TEMPORARY UTILITIES (POWER, LIGHTING, WATER) TO THE JOB SITE FOR USE BY ALL CONSTRUCTION TRADES, INCLUDING THOSE NOT A SUBCONTRACTOR TO THE GENERAL CONTRACTOR. CONTRACTOR TO PURCHASE WIND OR SOLAR RENEWABLE POWER SOURCES WHEN AVAILABLE.
- FOR WALLS SEPARATING GARAGE AND LIVING SPACE, PROVIDE (1) LAYER 5/8" TYPE 'X' GIB ON EACH SIDE OF STUDS. FOR CEILING ABOVE GARAGE SEPARATING GARAGE AND LIVING SPACE, PROVIDE (2) LAYERS 5/8" TYPE 'X' GIB AT CEILING. FOR CEILING OF STORAGE AREA BELOW STAIRS, PROVIDE (2) LAYERS 5/8" TYPE 'X' GIB AT CEILING.
- CONTRACTOR IS RESPONSIBLE FOR VERIFICATION OF ALL MATERIAL TAKE-OFFS DONE BY SUB-CONTRACTORS.

GENERAL FIREBLOCKING NOTES

- FIRE BLOCKS SHALL BE PROVIDED IN THE FOLLOWING LOCATIONS: (CONTRACTOR SHALL VERIFY WITH CURRENT CODES)
- IN CONCEALED SPACES OF STUD WALLS AND PARTITIONS, INCLUDING FURRED SPACES, AT CEILING AND FLOOR LEVELS.
 - IN CONCEALED SPACES OF STUD WALLS AND PARTITIONS, INCLUDING FURRED SPACES, AT 10-FOOT INTERVALS ALONG THE LENGTH OF THE WALL.
 - AT ALL INTERCONNECTIONS BETWEEN CONCEALED VERTICAL AND HORIZONTAL SPACES SUCH AS OCCUR AT SOFFITS, DROP CEILING AND COVE CEILING.
 - IN CONCEALED SPACES BETWEEN STAIR STRINGERS AT THE TOP AND BOTTOM OF THE RUN AND BETWEEN STUDS ALONG AND IN LINE WITH THE RUN OF THE STAIRS IF THE WALLS UNDER THE STAIRS ARE UNFINISHED.
 - IN OPENINGS AROUND VENTS, PIPES, DUCTS, CHIMNEYS, FIREPLACES AND SIMILAR OPENINGS THAT AFFORD A PASSAGE FOR FIRE AT CEILING AND FLOOR LEVELS, WITH NON-COMBUSTIBLE MATERIALS.
 - AT OPENINGS BETWEEN ATTIC SPACES AND CHIMNEY CHASES FOR FACTORY-BUILT CHIMNEYS.



COPYRIGHT 2021

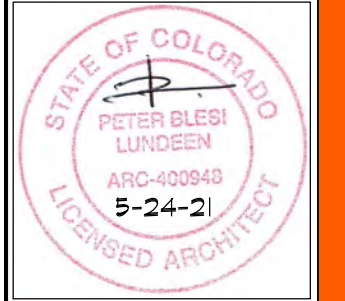

REVISIONS:

AR-52 RESIDENCE
 PROJECT: #2014
 LOCATION: AR-52 123 ADAMS WAY MOUNTAIN VILLAGE SAN MIGUEL COUNTY



GRAPHIC SYMBOLS LEGEND

DRAWING NO.	BUILDING SECTION TAG	WINDOW MARK	DETAIL SHEET
SHEET NO.	INTERIOR ELEVATION TAG	DOOR MARK	DETAIL REFERENCE OR TAG
TO SUBFLOOR	ELEVATION DATUM	REVISION AND A.S.I. NUMBER	ROOM NUMBER
CMU CUT IN PLAN/SECTION	STONE CUT IN PLAN/SECTION	CONCRETE	MORTAR/TEXTURED BED

SHEET INDEX

A1-0	TITLE SHEET
A1-1	SITE SURVEY
A2-1	SITE PLAN
A2-2	LANDSCAPE & FIRE MITIGATION PLAN
A2-3	CONSTRUCTION MITIGATION PLAN
1 of 4	DRB GRADING PLAN
2 of 4	DRB DRAINAGE & EROSION CONTROL PLAN
3 of 4	DRB UTILITY PLAN
4 of 4	CIVIL - DRB DRIVEWAY PROFILE
A3-1	LOWER AND MAIN LEVEL FLOOR PLANS
A3-2	UPPER LEVEL FLOOR PLAN AND ROOF PLAN
A4-1,2	EXTERIOR ELEVATIONS
A4-3,4	EXTERIOR ELEVATIONS - MAX. AVE. HT. CALCS
A4-5,6	EXTERIOR ELEVATIONS - MATERIAL CALCS
A4-7,8	EXTERIOR 3D MODEL VIEWS
LX0	SITE EXTERIOR LIGHTING PLAN
LX1	LOWER LEVEL EXTERIOR LIGHTING PLAN
LX2	MAIN LEVEL EXTERIOR LIGHTING PLAN
LX3	UPPER LEVEL EXTERIOR LIGHTING PLAN
LX4	EXTERIOR LIGHTING ELEVATIONS

ISSUE DATES

REVIEW SET	4-9-2021
REVIEW SET	5-24-2021

PROJECT INFORMATION

LEGAL DESCRIPTION:
 123 ADAMS WAY
 LOT AR-52R
 MOUNTAIN VILLAGE, CO 81435

BLDG. OCCUPANCY: RESIDENTIAL = R-3
CONSTRUCTION: VB

DESCRIPTION:
 3 STORY SINGLE FAMILY RESIDENCE

LOWER LEVEL = 1,296.6 SF (67.5 sf mech incl.)	PATIOS = 390 SF
MAIN LEVEL = 1,056.7 SF	DECKS = 485 SF
UPPER LEVEL = 991.8 SF	DECKS = 127 SF
TOTAL LIVING = 3,345.1 SF + 625 SF GARAGE = 3,970.1 SF GROSS BUILDING	

PROJECT TEAM

SURVEYOR	CIVIL ENGINEER	MECHANICAL ENGINEER	STRUCTURAL ENGINEER	GENERAL CONTRACTOR
ALL POINTS LAND SURV P.O. BOX 154 OPHIR, CO 81435	ALPINE LAND CONSULTING P.O. BOX 234 RICO, CO 81332	T.B.D.	T.B.D.	ULTRA BUILDERS RICKY DENESIK
(970) 708-9694	(970) 708-0326	-	-	(970) 729-1221 CELL

FOR REVIEW ONLY NOT FOR CONSTRUCTION

DATE: MAY 24, 2021
 ISSUED FOR: REVIEW SET
 SHEET NUMBER: A1-0 TITLESHEET

UNIT AR-53R1

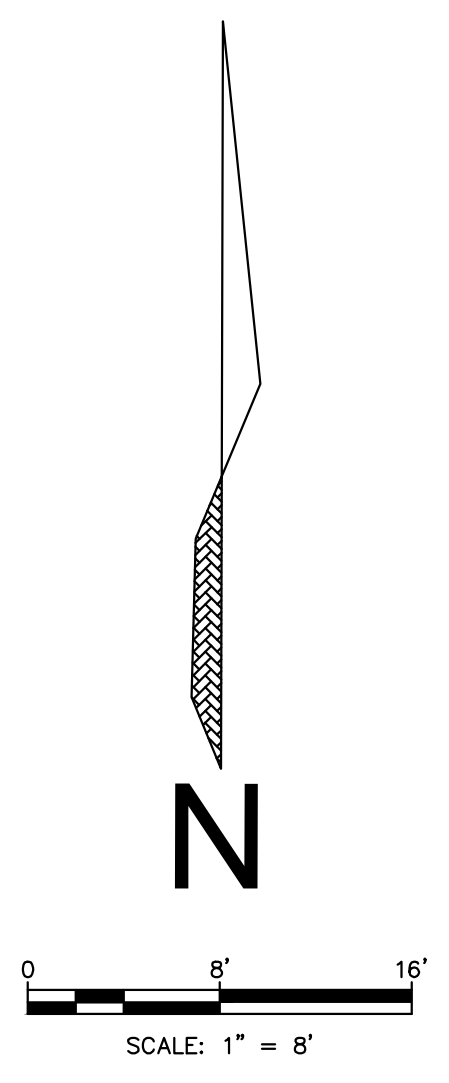

CONTOUR INTERVAL=1'

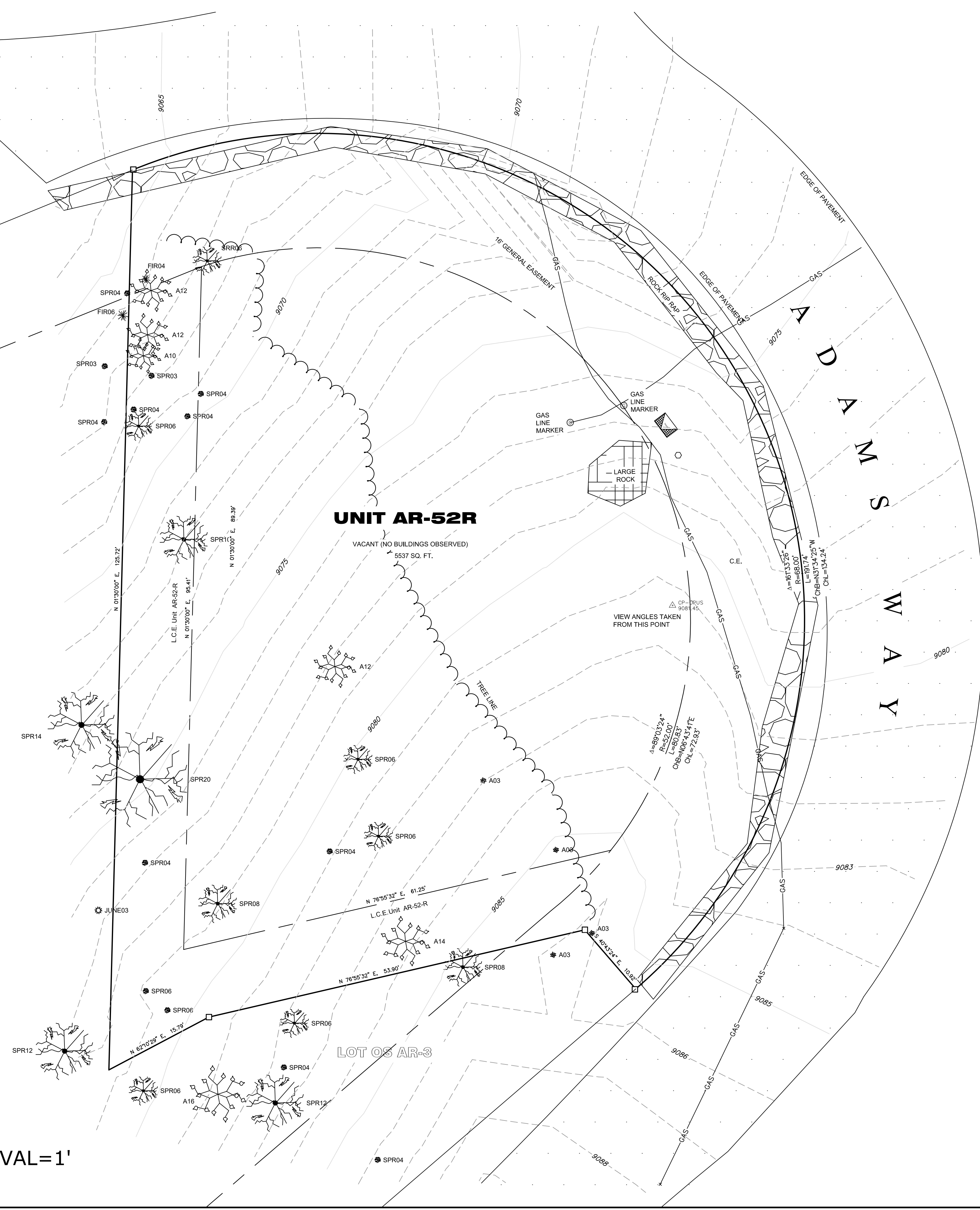

PROPERTY DESCRIPTION:

UNIT AR52R THE VILLAGE AT ADAMS RANCH ACCORDING TO THE THIRD AMEND TO THE COMMON OWNERSHIP COMMUNITY PLAT FOR THE VILLAGE AT ADAMS RANCH RECORDED 10 27 2005 PL BK 1 PG 3561-3563 RECEPTION NUMBER 379099 LOCATED ON LOT C-2BR1 INCLUDES 0.0435 PERCENT INTEREST IN COMMON ELEMENTS TOWN OF MOUNTAIN VILLAGE SAN MIGUEL COUNTY

SURVEYORS CERTIFICATE:

I, Thomas A. Clark, being a Colorado Licensed Land Surveyor, do hereby certify that this Topographic Survey of Lot AR-52R, Mountain Village was made by me and under my direct supervision, responsibility, and checking. This Topographic Survey does not constitute a Land Survey Plat or Improvement Survey Plat as defined by Title 38, Article 51 C.R.S.

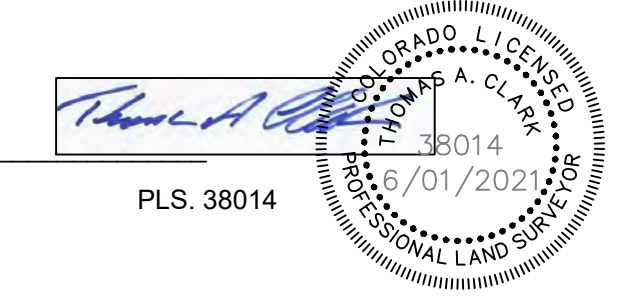

Thomas A. Clark PLS. 38014

NOTES:

- Easement research and property description provided by LAND TITLE GUARANTEE COMPANY - TELLURIDE, Order Number TLR86009773-6 effective on 4-29-2020 at 5:00 P.M.
- According to FEMA Flood Insurance Rate Map 008113C0300C Panel Number 0287 dated September 30, 1988 this parcel is within Zone X; Areas determined to be outside 500 year plain.
- Field work was performed in August 2020.
- Elevation datum for this survey are based on GPS observation and OBUS solution (NAVD 88) benchmark on Lot AR-52R, that elevation being 9081.45.
- This survey is valid only if a printed or electronic copy has a seal and signature of the surveyor noted within the statement above.
- This survey is prepared for the exclusive use of the party or parties indicated within the surveyor's statement. Said statement does not extend to any unnamed person or parties without an expressed statement by the surveyor naming said entities.
- NOTICE: According to Colorado law you must commence any legal action based upon defect in this survey within three years after you first discover such defect. In no event may any action based upon any defect in this survey be commenced more than ten years from the date of the certification shown hereon.

TREE CHART

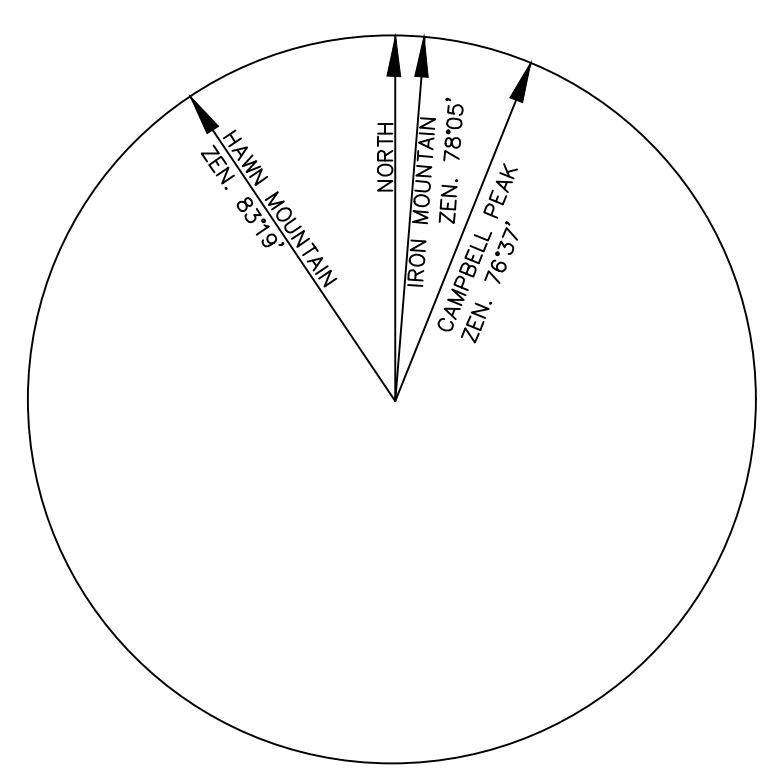
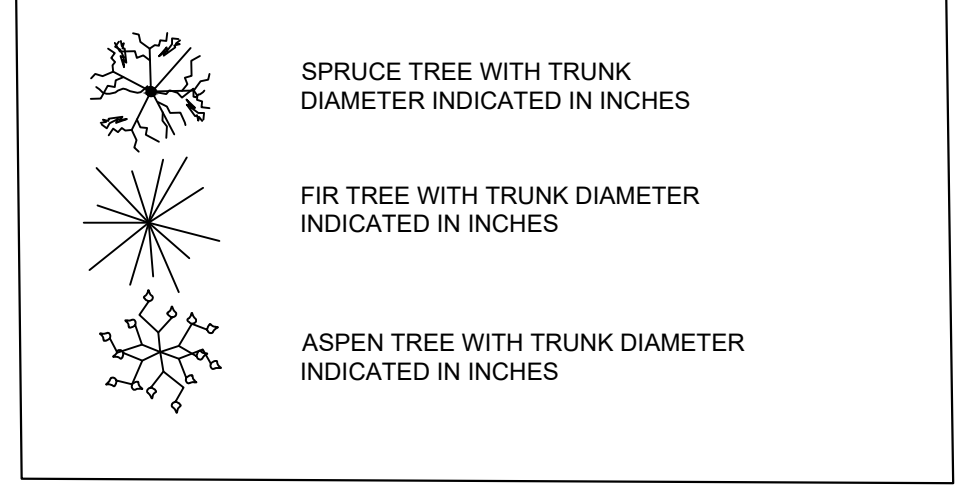

VIEW ANGLES
ANGLES ENUMERATED ARE ZENITH ANGLES

LEGEND:

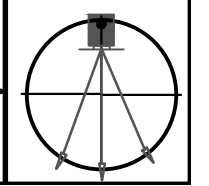
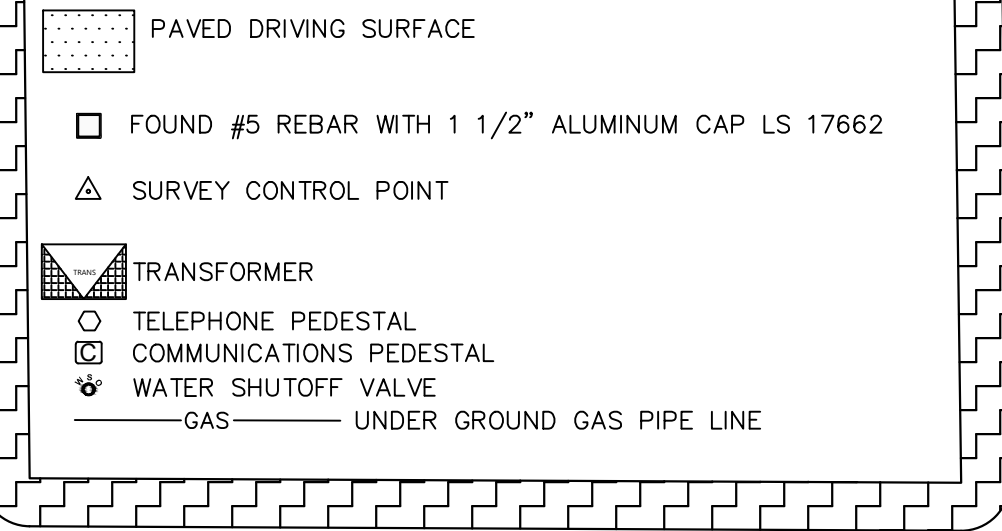

COPYRIGHT 2021

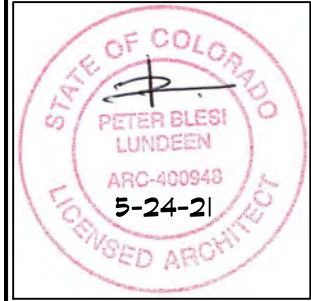

REVISIONS:

AR-52 RESIDENCE

PROJECT: #2014

DATE: MAY 24, 2021
ISSUED FOR: REVIEW SET

SHEET NUMBER: A2-1

LOCATION: AR-52 123 ADAMS WAY MOUNTAIN VILLAGE SAN MIGUEL COUNTY

FUSE architecture + interior

220 East Colorado Ave., Suite 218 P.O.Box 3934 Telluride CO 81435. Office: 970-728-0841

Lot AR-52R
123 Adams Way

Lot size 0.228 acre

Zone District Single family
Zoning Designations Single family

Floor Area			
Lower Level	1229.1		
Mechanical		67.5	
Main Level	1056.7		
Garage		625	
Upper Level	991.8		
	3277.6	692.5	3970.1 gross sq. ft.

Lot Coverage

3,588.0 sq. ft. footprint

0.228 acres
43,560 sq. ft. per acre
9,940.00 sq. ft. lot size

36.10% lot coverage

Max Build. Height 34'-11"
Ave. Bldg. Height 26'-0 3/4"

Parking
Required & provided 2 in garage

SITE LEGEND

	EXISTING CONTOUR
	REVISED CONTOUR
CONTOUR INTERVALS 2 FEET	
	GAS LINE
	ELECTRIC, CABLE, AND TELEPHONE LINES
	WATER LINE
	SANITARY SEWER LINE
	LINE OF DRAINAGE SWALE
	TREE TO BE REMOVED
	PARKING SPACE
	EXTERIOR LIGHTING
	GAS VALVE
	WATER VALVE
	CABLE TELEVISION PEDESTAL
	TELEPHONE PEDESTAL
	ELECTRIC PEDESTAL
	CURB STOP
	CONTROL POINT
	FIRE HYDRANT
	SANITARY SEWER MANHOLE

- GENERAL NOTES**
- SURVEY INFORMATION PROVIDED BY: ALL POINTS LAND SURVEY, LLC P.O. BOX 764 OFHEO, CO 81435 970-728-3694
 - CONTRACTOR TO CONFIRM ALL UTILITY LOCATIONS WITH EACH UTILITY AGENCY. ALL UTILITY TRENCHES TO AVOID DISTURBING EXISTING TREES.
 - THE CONTRACTOR SHALL VERIFY BUILDING LOCATION AND FLOOR ELEVATIONS WITH THE OWNER AND ARCHITECT PRIOR TO EXCAVATION.

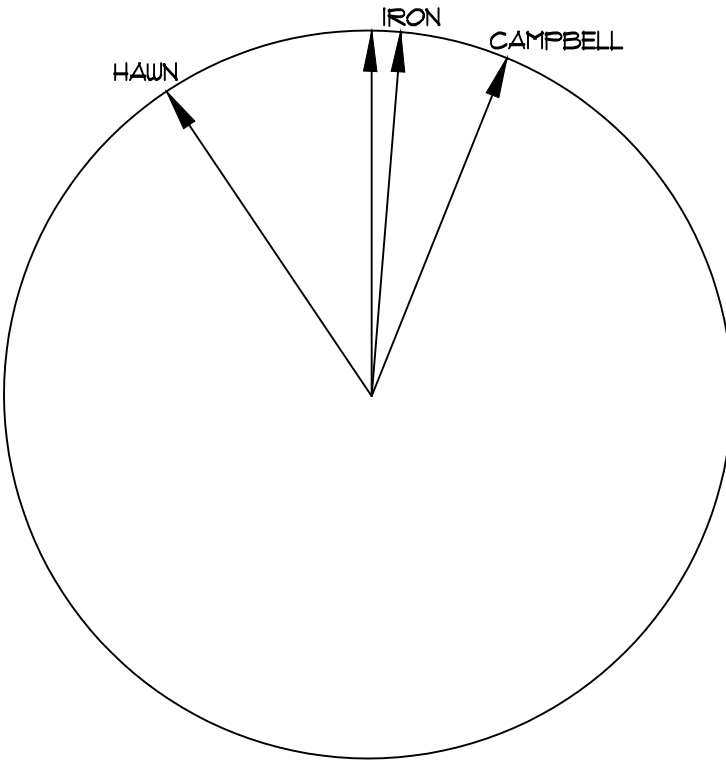
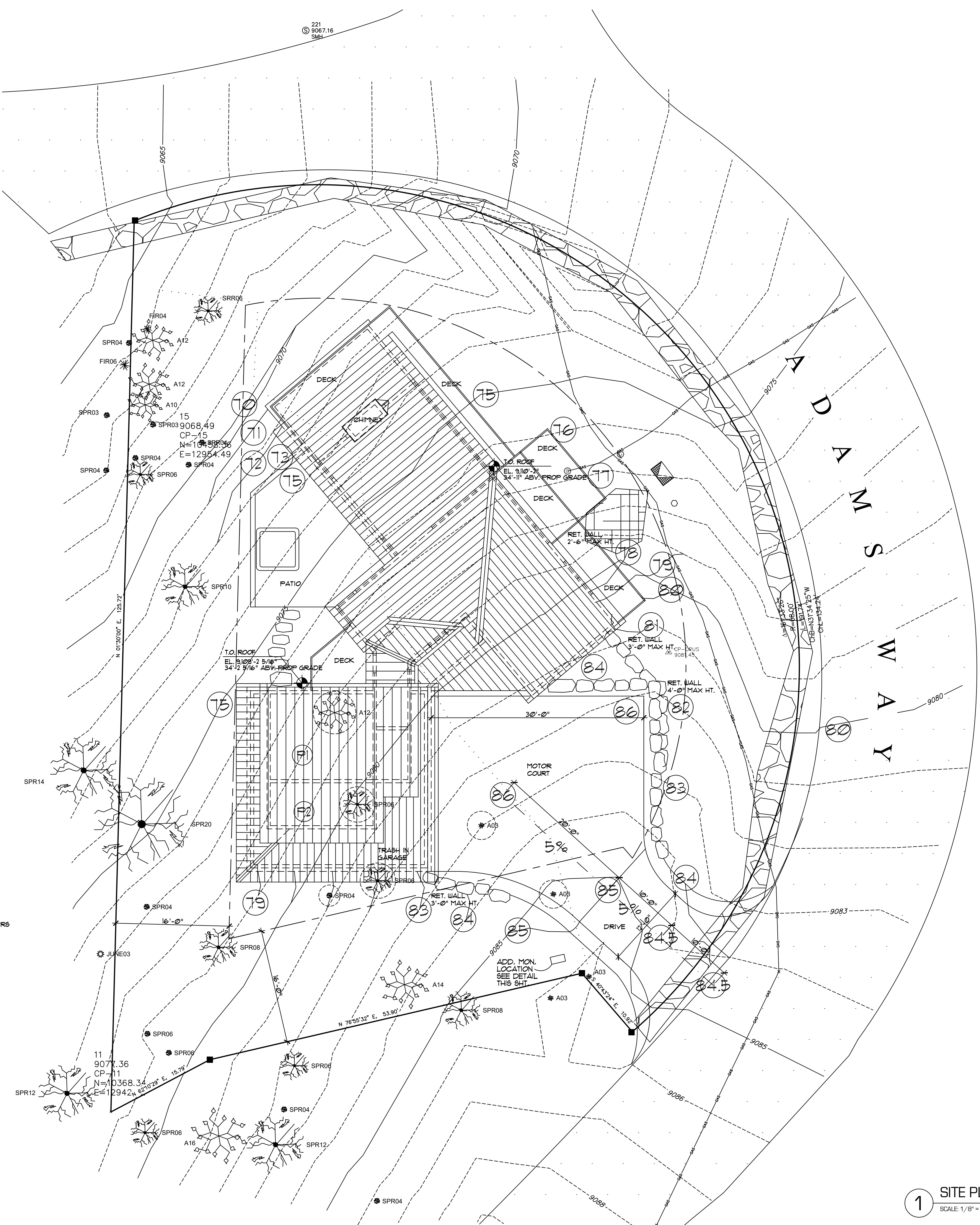

1 SITE PLAN
SCALE: 1/8" = 1'-0"

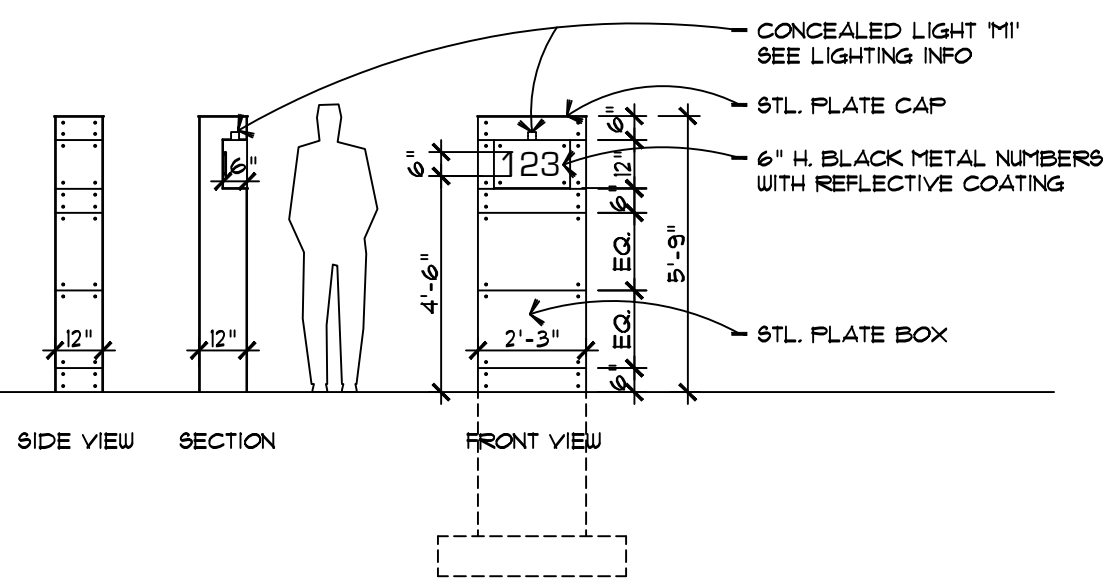

2 ADDRESS MONUMENT
SCALE: 1/4" = 1'-0"

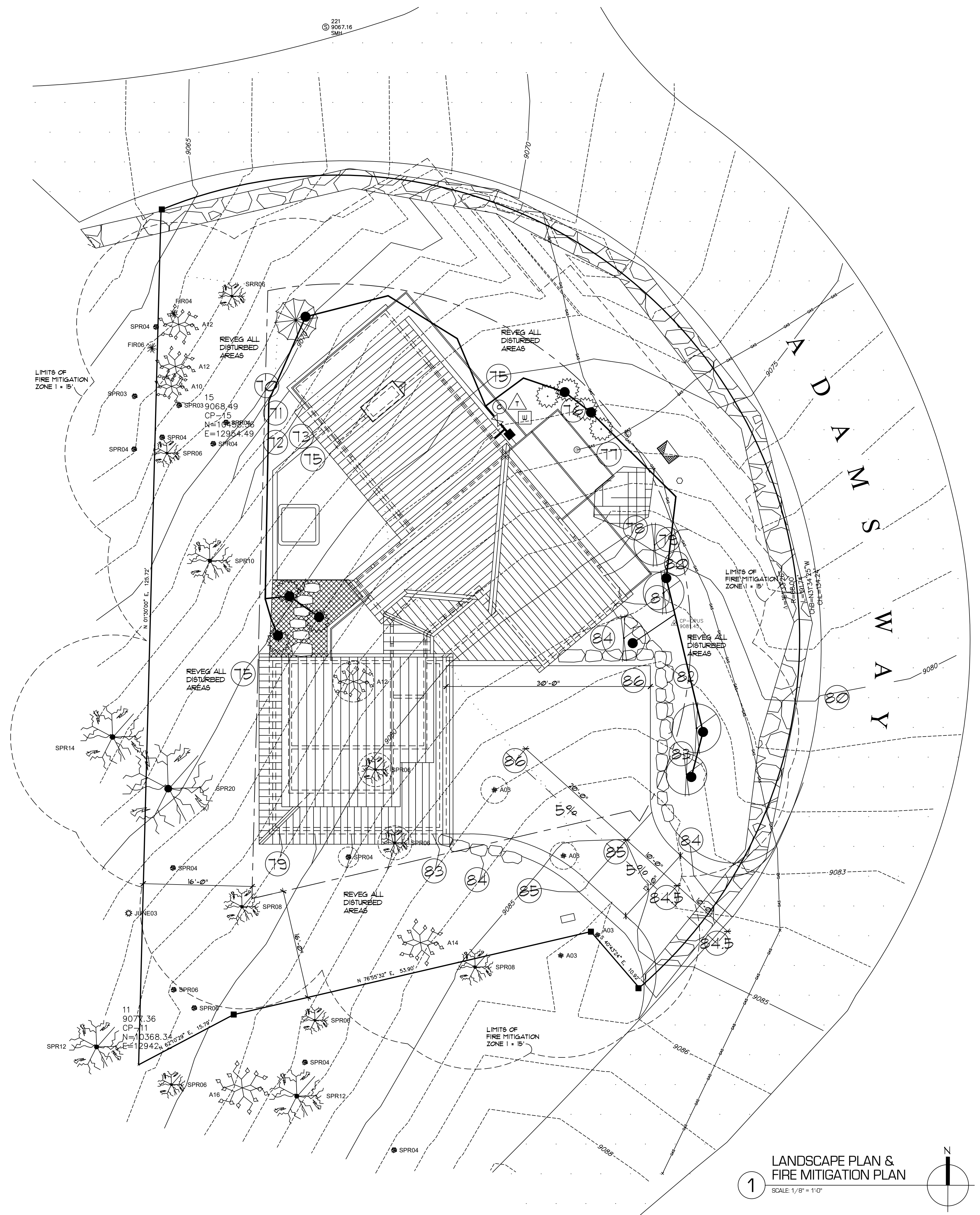

1 LANDSCAPE PLAN & FIRE MITIGATION PLAN
SCALE: 1/8" = 1'-0"

IRRIGATION LEGEND

- CLASS 200 PVC MAIN LINE 1"
- 3/4" 80NSF POLYTYPE LATERAL LINES
- ⊗ 1.5" WILKINS MODEL 500 PRESSURE REGULATOR
- △ TAP WITH RAINEIRD FVB-075 BACKFLOW PREVENTER
- RAINBIRD RCM-12 ELECTRO-MECHANICAL CONTROLLER
- RAINBIRD 150-FEB 1.5" ELECTRIC REMOTE CONTROL VALVE
- WATER SENSOR BY RAINEIRD
- ◇ IRRIGATION WATER METER WITH REMOTE READOUT

PLANT SCHEDULE/LEGEND

<ul style="list-style-type: none"> • NATIVE GRASS / REVEGETATION MIX (SEE REVEGETATION NOTES) ▨ PERENNIAL BEDS (TO BE IRRIGATED) GERANIUM FORGET ME NOT COLLETTIA DIGNA SPECTABILIS RANUNCULUS REPENS SAXIFRAGA ⊗ NEW SPRUCE (PICEA FUNGENS) SIZE: 8' TO 10' TALL QTY: 1 ⊙ NEW ASPEN (POPULUS TREMULOIDES) SIZE: 4" MIN. DIAM. QTY: 5 	<ul style="list-style-type: none"> ⊗ SHRUB NOTES: ALL SHRUBS TO BE NATIVE AND DROUGHT TOLERANT - LANDSCAPE SUB-CONTRACTOR TO REVIEW AND COORDINATE W/ ARCH. & OWNER ⊗ NEW MUGO FINE (PINUS MUGO) SIZE: 1 GALLON or 24" (VERIFY) QTY: 1 - OR - ⊗ ALTERNATE OPTION (VER. W/ OWNER) NEW SNOWBERRY (SYMPLOCARPUS ALEUTICUS) SIZE: 5 GALLON (VERIFY) QTY: 1
---	--

REVEGETATION NOTES

- SUBSOIL SURFACE SHALL BE TILLED TO A 6" DEPTH IN NON FILL AREAS.
- TOPSOIL SHALL BE SPREAD AT A MINIMUM DEPTH OF 4" OVER ALL AREAS TO BE REVEGETATED.
- BROADCASTING OF SEED AND MULCHING SHALL BE DONE IMMEDIATELY AFTER TOPSOIL IS APPLIED TO MINIMIZE EROSION AND WEED INFESTATION.
- DRILL SEED USING SPECIFIED SEED MIX AND FOLLOW WITH DRY MULCHING. STRAW OR HAY SHALL BE UNIFORMLY APPLIED OVER SEEDED AREA AT A RATE OF 1.5 TONS PER ACRE FOR HAY OR 2 TONS PER ACRE FOR STRAW.
- TACK WITH ORGANIC TACKIFIER AT 100 POUNDS PER ACRE.
- FOR STEEP SLOPES 3:1 OR GREATER, USE EXCELSIOR EROSION CONTROL BLANKET DOUBLE SIDED.

1. SEED ALL AREAS LABELED "NATIVE GRASS SEED" OR "REVEG AREA" WITH THE FOLLOWING MIX (TO BE VERIFIED WITH TMY MIX). NO NOXIOUS WEED TO BE INCLUDED IN THE REVEGETATION AREAS.

NATIVE MIX (GENERAL REVEGETATION)	UPLAND MIX (WETLANDS BUFFER MIX)
WESTERN YARROW 5%	ARIZONA FESCUE 14%
TALL FESCUE 10%	ALPINE BLUEGRASS 14%
ARIZONA FESCUE 5%	SLENDER WHEATGRASS 36%
HARD FESCUE 5%	MOUNTAIN BROME 36%
CREeping RED FESCUE 10%	
ALPINE BLUEGRASS 15%	
CANADA BLUEGRASS 10%	
PERENNIAL RYEGRASS 15%	
SLENDER WHEATGRASS 10%	
MOUNTAIN BROME 15%	

SEED RATES:
IF A SEED DRILL IS USED, 6-10 PLS/ACRE
OTHERWISE, 8-12 PLS/ACRE
PLS = PURE LIVE SEED (TO BE VERIFIED WITH LANDSCAPE SUB-CONTRACTOR)

8. ALL REGRADED AREAS ARE TO BE REVEGETATED ACCORDING TO APPLICABLE DESIGN REGULATIONS.

GENERAL LANDSCAPING NOTES

- PROTECT TREES AND VEGETATION NEAR DISTURBANCE AREAS WITH HAY BALES AND FENCING AS REQ'D.
- THE GENERAL CONTRACTOR'S LANDSCAPING SUBCONTRACTOR SHALL SUBMIT AN IRRIGATION PLAN AND SHOP DRAWINGS TO THE OWNER, ARCHITECT, AND BUILDING DEPARTMENT, IF APPLICABLE.
- ALL TREE & SHRUB LOCATIONS, SPECIES AND QUALITY SHALL BE FIELD VERIFIED PRIOR TO FINAL PLANTING.
- ALL TREE & SHRUB PLANTINGS SHALL BE BACKFILLED WITH A TOPSOIL / ORGANIC SOIL AMENDMENT MIXTURE AT A 2:1 RATIO. PROPOSED SOIL AMENDMENTS SELECTED BY LANDSCAPE CONTRACTOR SHALL BE APPROVED PRIOR TO USAGE BY LANDSCAPE ARCHITECT / ARCHITECT.
- ALL TREES GREATER THAN 6' IN HEIGHT SHALL BE STAKED WITH METAL T-POSTS AND/OR DUCKBILL ANCHORING SYSTEMS. TREES SHALL BE GUYED WITH 12 GAUGE GALVANIZED WIRE AND POLY-PROPYLENE TREE BRACE STRAPS. DECIDUOUS TREES SHALL REQUIRE A MINIMUM OF TWO STRAPPING SYSTEMS WHILE EVERGREEN TREES SHALL REQUIRE A MINIMUM OF THREE. STAKING AND STRAPS SHALL BE REMOVED AFTER TWO GROWING SEASONS.
- SOD AREA SOILS SHALL BE TILLED TO A 6" DEPTH AND MIXED WITH ORGANIC SOIL AMENDMENT MIXTURE AT A 2:1 RATIO.
- ALL PLANT MATERIAL SHALL MEET THE AMERICAN NURSERYMEN'S ASSOC. STANDARDS FOR NURSERY STOCK. PLANTING DETAILS FOR ROOT SYSTEMS, SOIL PREPARATION, SEEDING, MULCHING, AND FERTILIZATION TECHNIQUES SHALL BE IN ACCORDANCE WITH GUIDELINES SET FORTH BY THE ASSOCIATED LANDSCAPE CONTRACTORS OF COLORADO.

FOR REVIEW ONLY NOT FOR CONSTRUCTION

DATE: MAY 24, 2021
ISSUED FOR: REVIEW SET

SHEET NUMBER: A2-2
LANDSCAPE PLAN

PROJECT: #2014

LOCATION: AR-52 123 ADAMS WAY MOUNTAIN VILLAGE SAN MIGUEL COUNTY

AR-52 RESIDENCE

REVISIONS:

COPYRIGHT 2021

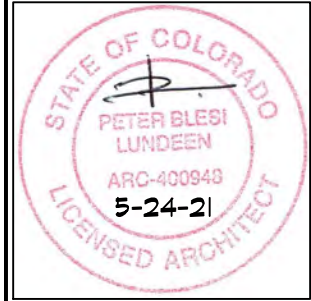

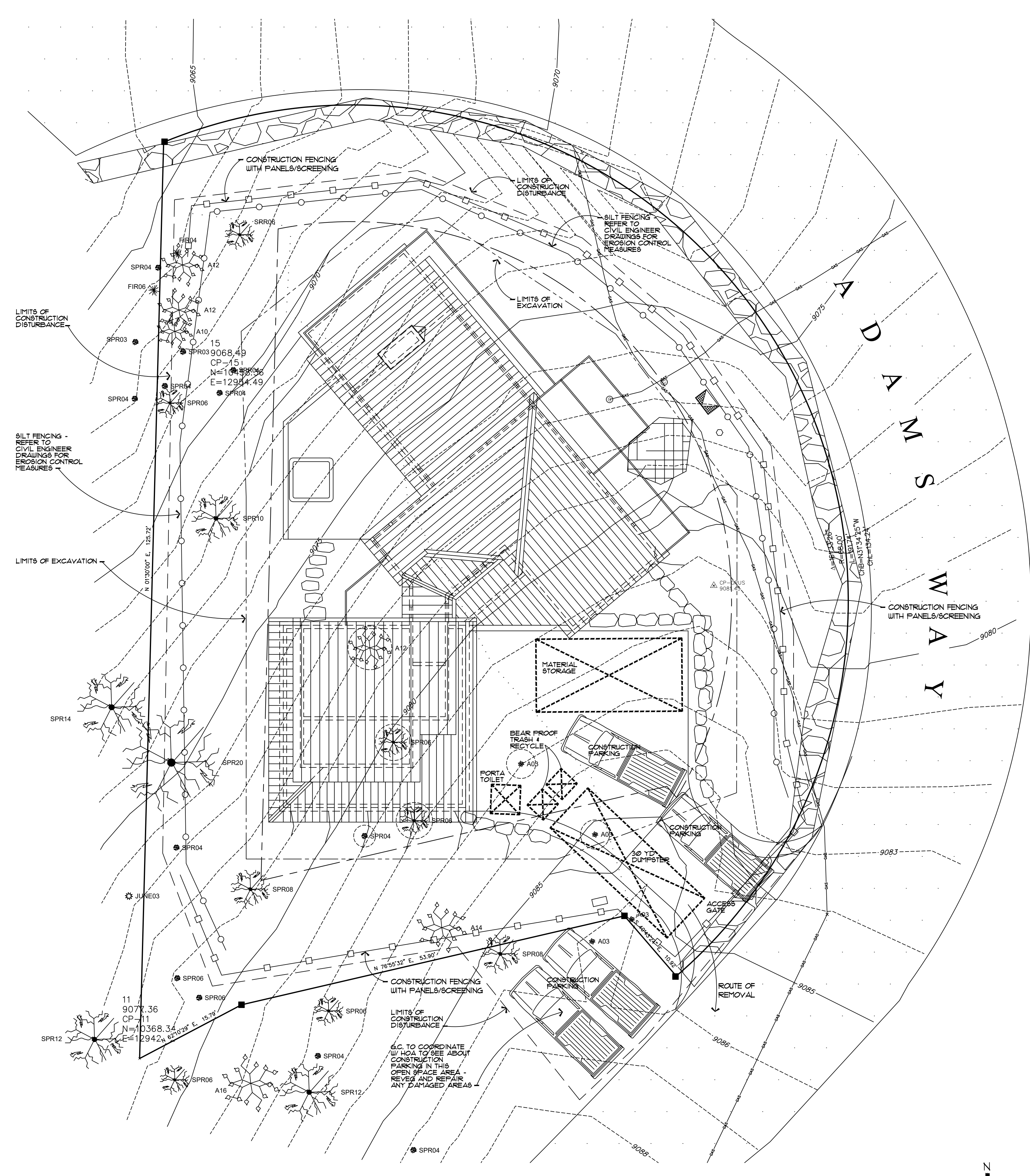

STAGING LEGEND

---	LIMITS OF CONSTRUCTION DISTURBANCE
.....	LIMITS OF EXCAVATION
—○—○—	CONSTRUCTION FENCING WITH PANELS/SCREENING
—●—●—	SILT FENCING
□□□□	STRAW/HAY BALES

SITE LEGEND

—	EXISTING CONTOUR
③⑥	REVISED CONTOUR CONTOUR INTERVALS 2 FEET
—○—○—○—	GAS LINE
—●—●—●—●—	ELECTRIC, CABLE, AND TELEPHONE LINES
—v—v—v—v—	WATER LINE
—■—■—■—■—	SANITARY SEWER LINE
—	LINE OF DRAINAGE SWALE
○	TREE TO BE REMOVED
Ⓟ	PARKING SPACE
⊕	EXTERIOR LIGHTING
⊕v	GAS VALVE
⊕w	WATER VALVE
Ⓜ	CABLE TELEVISION PEDESTAL
Ⓣ	TELEPHONE PEDESTAL
Ⓜ	ELECTRIC PEDESTAL
Ⓜ	CURB STOP
Ⓜ	CONTROL POINT
Ⓜ	FIRE HYDRANT
Ⓜ	SANITARY SEWER MANHOLE

- NOTES:**
1. THE CONTRACTOR IS RESPONSIBLE FOR OBTAINING FINAL APPROVAL FROM T.M.V. BLDG. DEPT. FOR ALL CONSTRUCTION STAGING IN THE FIELD PRIOR TO CONSTRUCTION.
 2. THE CONTRACTOR IS RESPONSIBLE FOR KEEPING ALL CLEARING AND EXCAVATION WITHIN EXISTING PROPERTY LINE BOUNDARIES AND GENERAL EASEMENTS.
 3. THE CONTRACTOR IS RESPONSIBLE FOR COORDINATING ANY REVISIONS OR ALTERATIONS TO THE CONSTRUCTION MITIGATION PLAN PRIOR TO CONSTRUCTION.
 4. PROVIDE SILT FENCING AND HAYBALES AS REQUIRED FOR TEMPORARY EROSION CONTROL AT ALL LOCATIONS DOWN SLOPE FROM THE AREA OF DISTURBANCE AND EXCAVATION. SEE CIVIL ENGINEERING DRAWINGS.
 5. PROTECT TREES AND VEGETATION NEAR DISTURBANCE AREAS WITH HAY BALES AND FENCING AS REQ'D.
 6. ALL PAINT, STAIN, THINNERS, AND RELATED MATERIALS SHALL BE DISPOSED OF IN A PROPER MANNER AND IN ACCORDANCE WITH LOCAL, STATE AND FEDERAL GUIDELINES REGARDING HAZARDOUS MATERIALS AND HAZARDOUS WASTE. AT NO TIME WILL ANY WASTES BE ALLOWED TO BE Poured OR SPILLED ONTO OR INTO THE SOIL. TRASH CONTAINERS OR ANY OTHER NON-SPECIFIC DEVICE/CONTAINER. ONLY CLEARLY MARKED FIRE PROOF DRUMS OR BUCKETS WILL BE ACCEPTABLE CONTAINERS.

FOR REVIEW ONLY NOT FOR CONSTRUCTION

DATE: MAY 24, 2021
ISSUED FOR: REVIEW SET

PROJECT: #2014

SHEET NUMBER: A2-3
CONSTRUCT MITIGATION PLAN

LOCATION: AR-52 123 ADAMS WAY MOUNTAIN VILLAGE SAN MIGUEL COUNTY

PROJECT: AR-52 RESIDENCE

REVISIONS:

COPYRIGHT 2021

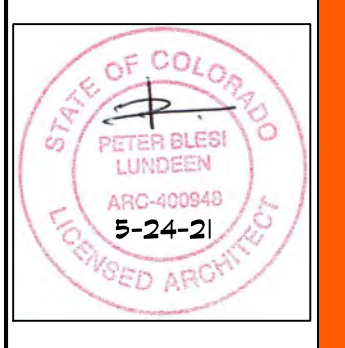

1 CONSTRUCTION MITIGATION PLAN
SCALE: 1" = 30' 0"

LEGEND

FF = FINISHED FLOOR
 FG = FINISHED GRADE

NOTES

1. THIS IS A PLANNING DOCUMENT ONLY AND NOT TO BE USED FOR CONSTRUCTION.
2. ALL EXISTING BOUNDARY, UTILITY, AND TOPOGRAPHIC INFORMATION PROVIDED BY ALL POINT LAND SURVEY LLC ON TOPOGRAPHIC MAP OF UNIT AR-52R, TELLURIDE MOUNTAIN VILLAGE DATED 8/5/2020. BENCHMARK ON LOT AR-52R WITH ASSUMED ELEVATION OF 9081.45. CONTACT TOM CLARK AT (970) 708-9694 FOR MORE BENCHMARK INFORMATION. SOME OF THE UTILITY SERVICES LOCATIONS SHOWN ON THIS PLAN ARE FROM MAPPING AS-BUILT INFORMATION ONLY AND NOT CONFIRMED.
3. MAXIMUM SLOPE GRADING TO BE 3(HORIZONTAL):1(VERTICAL). ANY SLOPE OVER 3:1 TO BE CONFIRMED BY GEOTECH ENGINEER.
4. ALL RETAINING WALL HEIGHTS ARE FINISHED GRADE TO FINISHED GRADE (RETAINED HEIGHT) AND DO NOT INCLUDE FOUNDATIONS OR CAPS.
5. RETAINING WALLS WITH PEDESTRIAN/VEHICULAR ACCESS REQUIRE HAND RAILS FOR ALL RETAINED HEIGHT AT OR OVER 2.5' (SEE ARCHITECTURAL, STRUCTURAL, AND/OR LANDSCAPE PLANS).

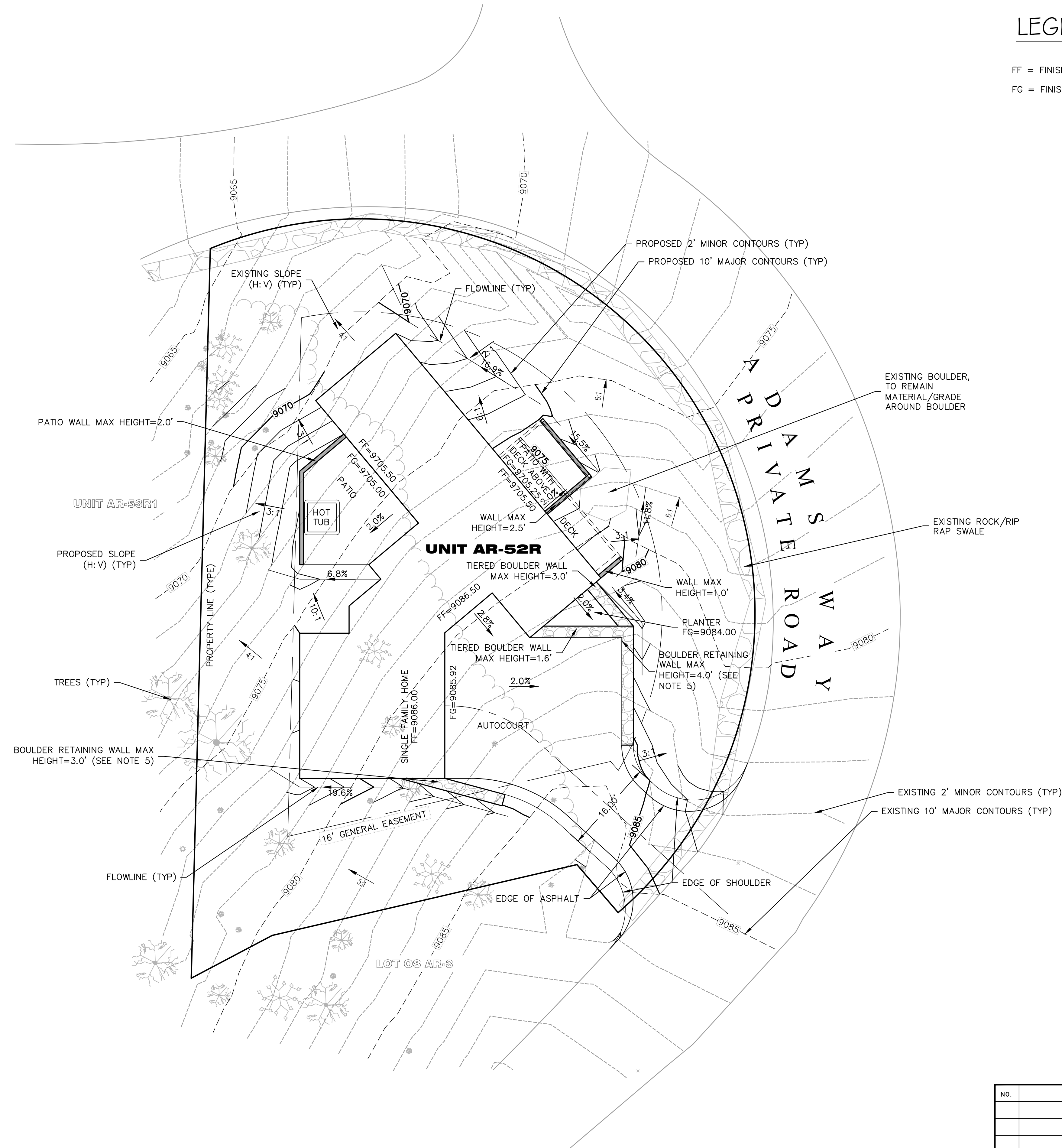

FOR DRB ONLY AND NOT FOR CONSTRUCTION

CALL UTILITY NOTIFICATION
 CENTER OF COLORADO
1-800-922-1987
 OR
811
 CALL 2-BUSINESS DAYS IN ADVANCE
 BEFORE YOU DIG, GRADE, OR
 EXCAVATE FOR THE MARKING OF
 UNDERGROUND MEMBER UTILITIES.

ALPINE LAND CONSULTING, LLC
 P.O. BOX 234
 RICO, COLORADO 81332
 970-708-0326
 GREGG@ALPINELANDCONSULTING.COM

THESE DRB PLANNING DOCUMENTS WERE PREPARED BY ME AND UNDER MY DIRECT SUPERVISION ON BEHALF OF ALPINE LAND CONSULTING, LLC FOR ADAMS WAY, LLC AND INCLUDES PRELIMINARY DRB PLANNING DESIGN ONLY, AND DOES NOT INCLUDE ANY OTHER PLANNING OR ENGINEERING.



GREGORY E. ANDERSON
 COLORADO PROFESSIONAL ENGINEER
 REGISTRATION NO. 35736

AR-52R TOWN OF MOUNTAIN VILLAGE
 DRB GRADING PLAN

CLIENT:
 ADAMS WAY LLC
 PO BOX 22183
 TELLURIDE, CO 81435

DATE: MAY 11, 2021

PROJECT #: 2021002

PROJECT MANAGER: GEA
 DRAWN BY: ADM

SHEET #:

1 OF 4

NO.	REVISIONS	DATE

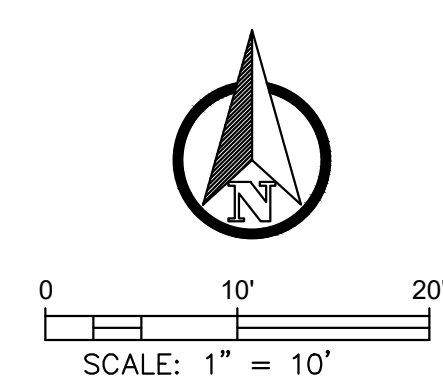

DRB GRADING PLAN

LEGEND

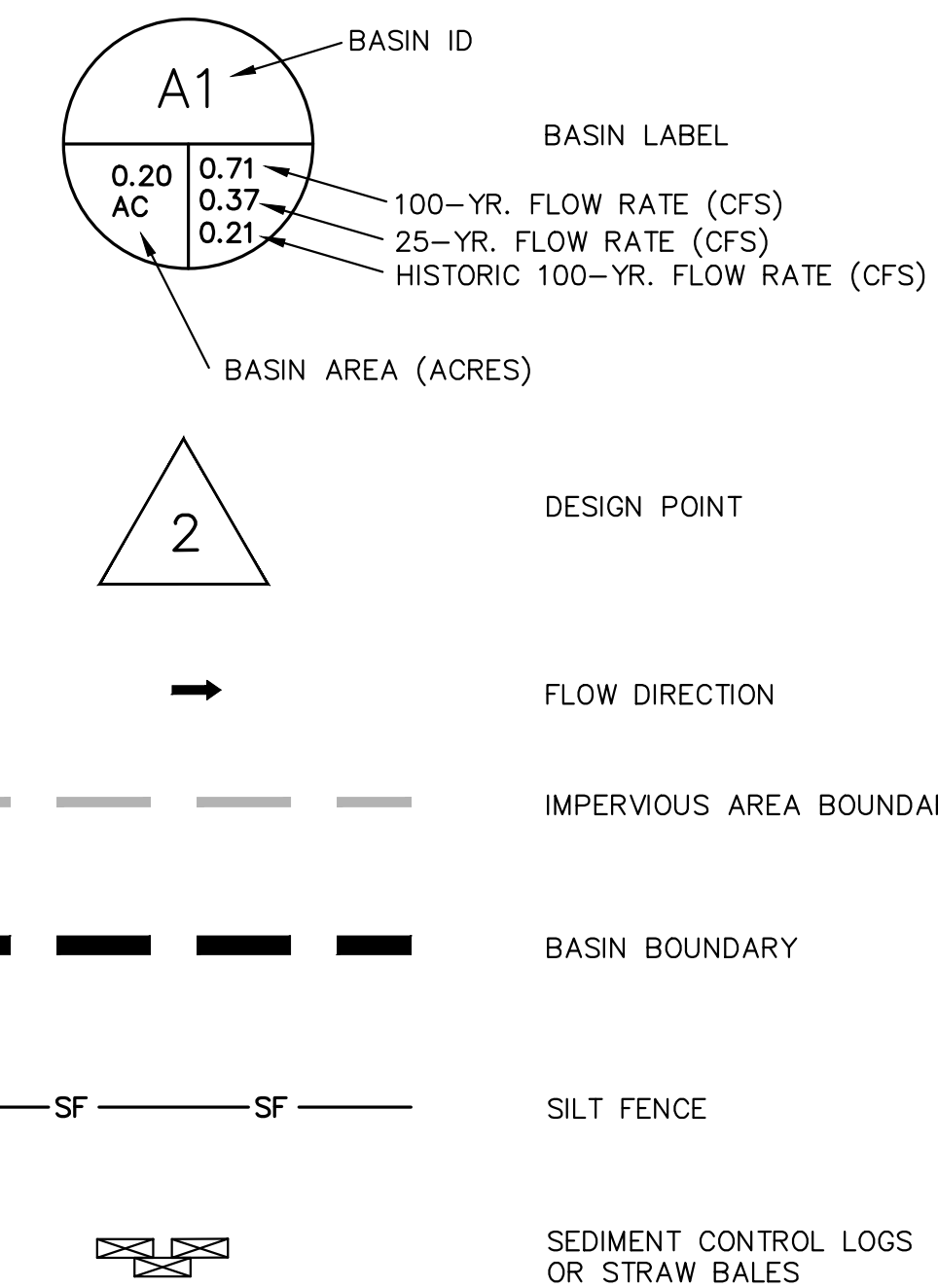

NOTES

- THIS IS A PLANNING DOCUMENT ONLY AND NOT TO BE USED FOR CONSTRUCTION.
- ALL EXISTING BOUNDARY, UTILITY, AND TOPOGRAPHIC INFORMATION PROVIDED BY ALL POINT LAND SURVEY LLC ON TOPOGRAPHIC MAP OF UNIT AR-52R, TELLURIDE MOUNTAIN VILLAGE DATED 8/5/2020. BENCHMARK ON LOT AR-52R WITH ASSUMED ELEVATION OF 9081.45. CONTACT TOM CLARK AT (970) 708-9694 FOR MORE BENCHMARK INFORMATION. SOME OF THE UTILITY SERVICES LOCATIONS SHOWN ON THIS PLAN ARE FROM MAPPING AS-BUILT INFORMATION ONLY AND NOT CONFIRMED.
- MAXIMUM SLOPE GRADING TO BE 3(HORIZONTAL):1(VERTICAL). ANY SLOPE OVER 3:1 TO BE CONFIRMED BY GEOTECH ENGINEER.
- ALL RETAINING WALL HEIGHTS ARE FINISHED GRADE TO FINISHED GRADE (RETAINED HEIGHT) AND DO NOT INCLUDE FOUNDATIONS OR CAPS.
- RETAINING WALLS WITH PEDESTRIAN/VEHICULAR ACCESS REQUIRE HAND RAILS FOR ALL RETAINED HEIGHT AT OR OVER 2.5' (SEE ARCHITECTURAL, STRUCTURAL, AND/OR LANDSCAPE PLANS).

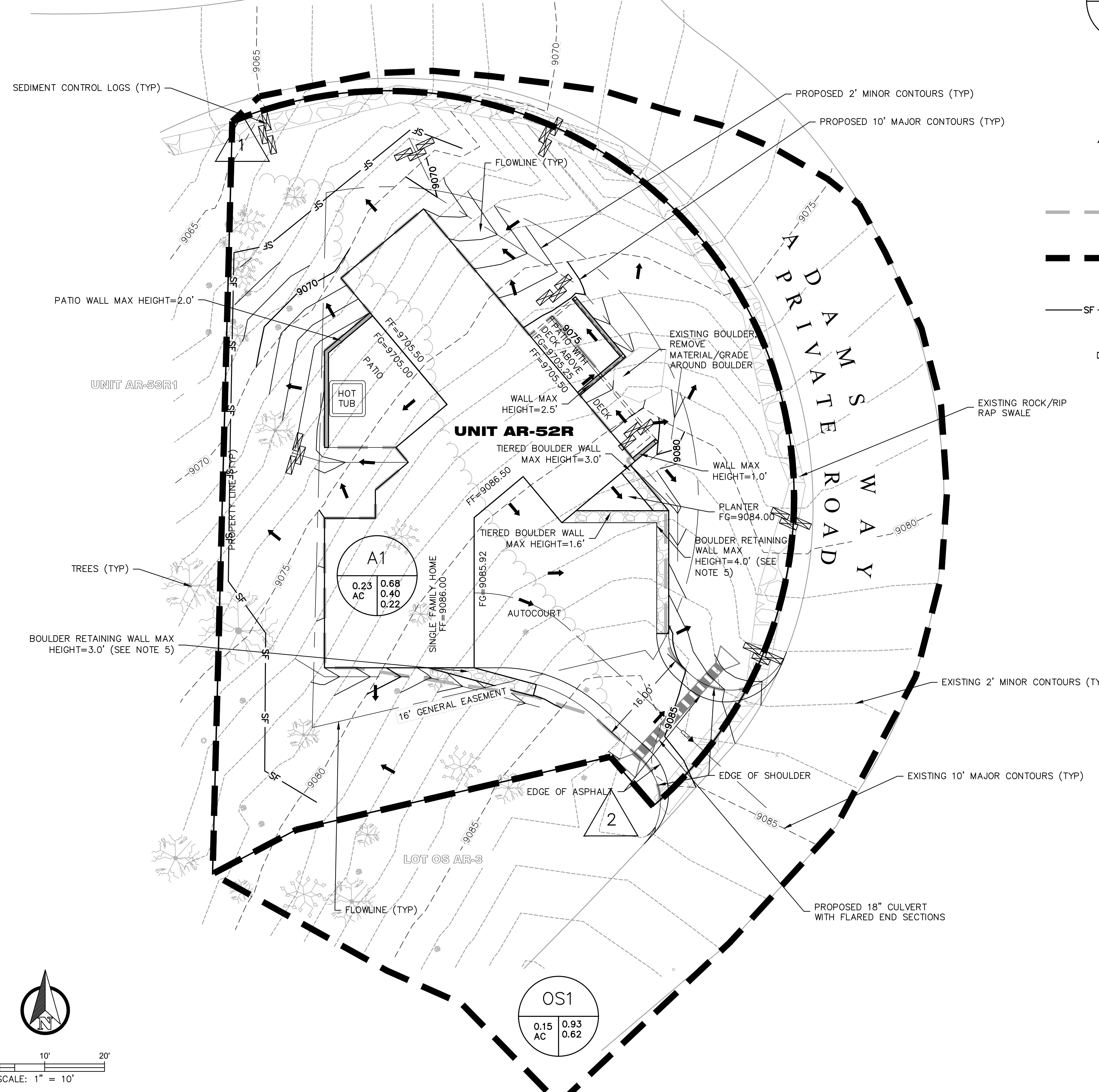

FOR DRB ONLY AND NOT FOR CONSTRUCTION

CALL UTILITY NOTIFICATION CENTER OF COLORADO
1-800-922-1987
 OR
811
 CALL 2-BUSINESS DAYS IN ADVANCE BEFORE YOU DIG, GRADE, OR EXCAVATE FOR THE MARKING OF UNDERGROUND MEMBER UTILITIES.

ALPINE LAND CONSULTING, LLC
 P.O. BOX 234
 RICO, COLORADO 81332
 970-708-0326
 GREGG@ALPINELANDCONSULTING.COM

THESE DRB PLANNING DOCUMENTS WERE PREPARED BY ME AND UNDER MY DIRECT SUPERVISION ON BEHALF OF ALPINE LAND CONSULTING, LLC FOR ADAMS WAY, LLC AND INCLUDES PRELIMINARY DRB PLANNING DESIGN ONLY, AND DOES NOT INCLUDE ANY OTHER PLANNING OR ENGINEERING.

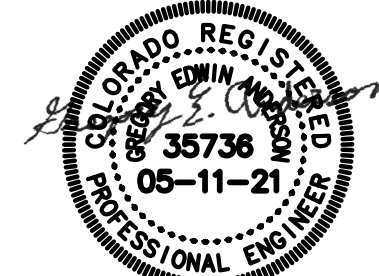

GREGORY E. ANDERSON
 COLORADO PROFESSIONAL ENGINEER
 REGISTRATION NO. 35736

AR-52R TOWN OF MOUNTAIN VILLAGE
 DRB DRAINAGE PLAN

CLIENT:
 ADAMS WAY LLC
 PO BOX 22183
 TELLURIDE, CO 81435

DATE: MAY 11, 2021

PROJECT #: 2021002

PROJECT MANAGER: GEA
DRAWN BY: ADM

SHEET #:

2 OF 4

NO.	REVISIONS	DATE

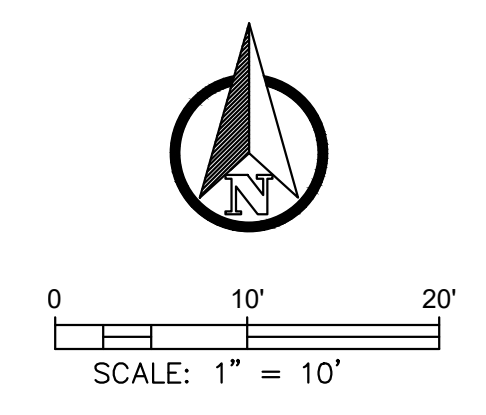

DRB DRAINAGE PLAN

NOTES

1. THIS IS A PLANNING DOCUMENT ONLY AND NOT TO BE USED FOR CONSTRUCTION.
2. ALL EXISTING BOUNDARY, UTILITY, AND TOPOGRAPHIC INFORMATION PROVIDED BY SAN JUAN SURVEYING INC ON ISP OF LOT 729-R5 DATED 8/17/2020. CONTACT CHRIS KENNEDY AT (970) 728-1128 FOR MORE BENCHMARK INFORMATION. SOME OF THE UTILITY SERVICES LOCATIONS SHOWN ON THIS PLAN ARE FROM MAPPING AS-BUILT INFORMATION ONLY AND NOT CONFIRMED.
3. ALL UTILITY LOCATES TO BE PERFORMED PRIOR TO FINAL DESIGN. IT IS RECOMMEND THAT THE SEWER TAP IS POT HOLED PRIOR TO FINAL DESIGN IN ORDER TO DETERMINE IF THE SEWER REQUIRES A PUMP IN THE MECHANICAL ROOM.

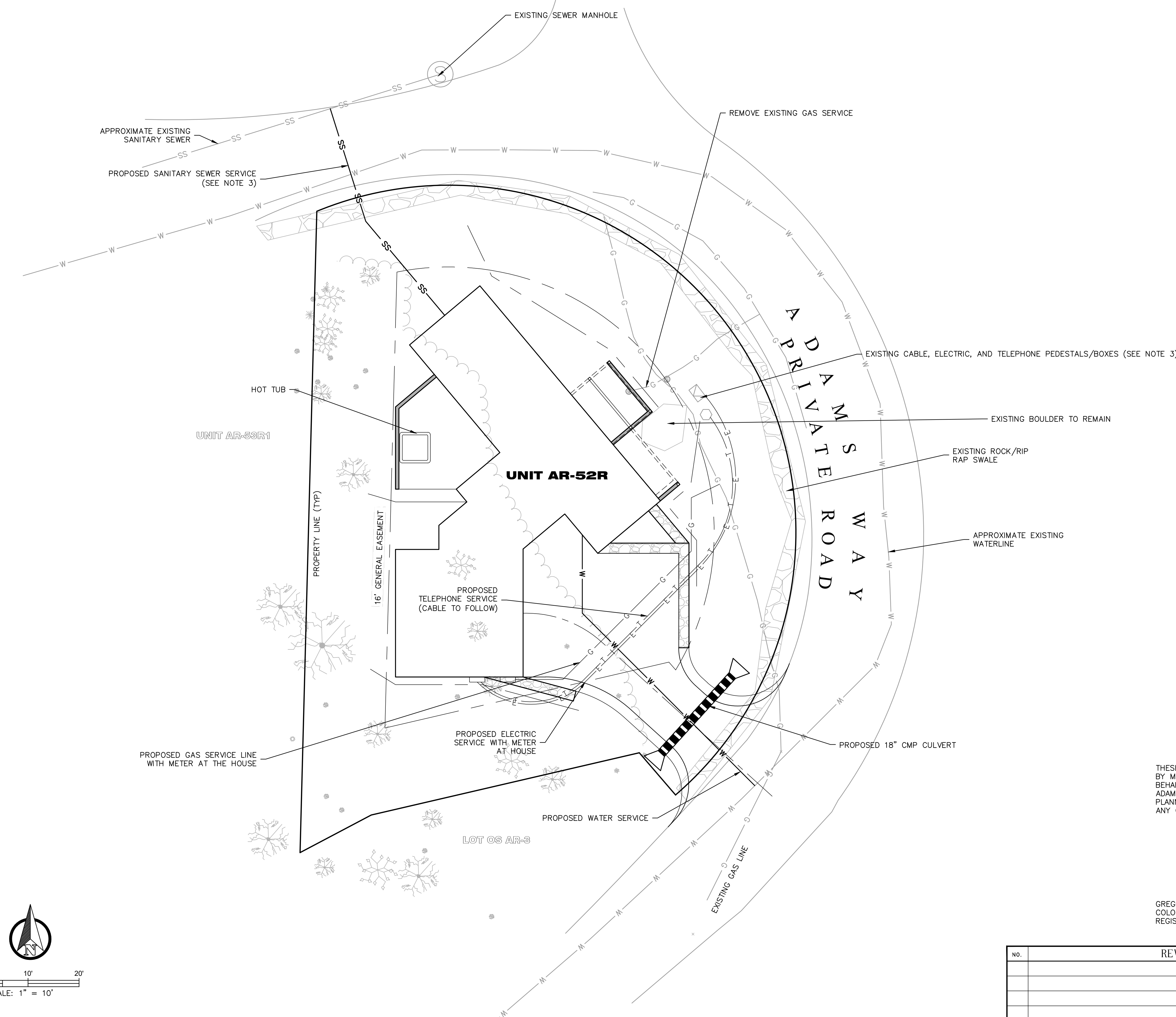

FOR DRB ONLY AND NOT FOR CONSTRUCTION

CALL UTILITY NOTIFICATION
CENTER OF COLORADO
1-800-922-1987
OR
811
CALL 2-BUSINESS DAYS IN ADVANCE
BEFORE YOU DIG, GRADE, OR
EXCAVATE FOR THE MARKING OF
UNDERGROUND MEMBER UTILITIES.

THESE DRB PLANNING DOCUMENTS WERE PREPARED BY ME AND UNDER MY DIRECT SUPERVISION ON BEHALF OF ALPINE LAND CONSULTING, LLC FOR ADAMS WAY, LLC AND INCLUDES PRELIMINARY DRB PLANNING DESIGN ONLY, AND DOES NOT INCLUDE ANY OTHER PLANNING OR ENGINEERING.



GREGORY E. ANDERSON
COLORADO PROFESSIONAL ENGINEER
REGISTRATION NO. 35736



AR-52R TOWN OF
MOUNTAIN VILLAGE
DRB UTILITY PLAN

CLIENT:
ADAMS WAY LLC
PO BOX 22183
TELLURIDE, CO 81435

DATE: MAY 11, 2021

PROJECT #: 2021002

PROJECT MANAGER: GEA
DRAWN BY: ADM

SHEET #:

3 OF 4

NO.	REVISIONS	DATE

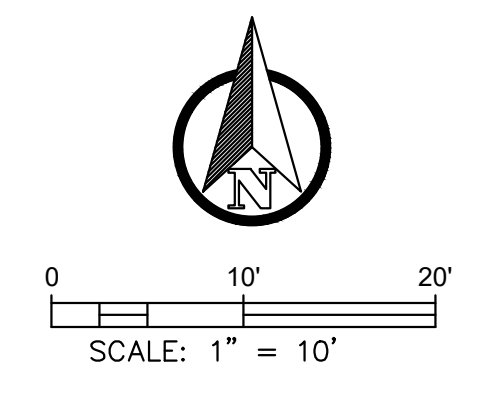

DRB UTILITY PLAN

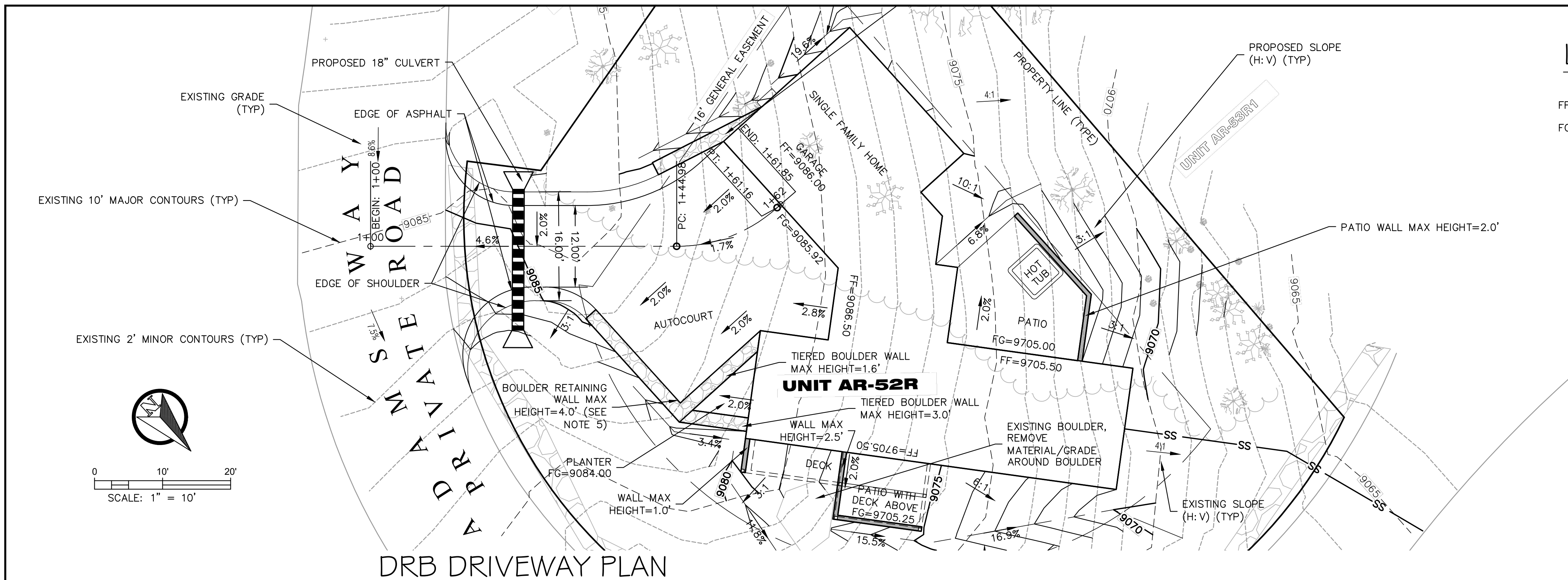

LEGEND

FF = FINISHED FLOOR
FG = FINISHED GRADE

NOTES

1. THIS IS A PLANNING DOCUMENT ONLY AND NOT TO BE USED FOR CONSTRUCTION.
2. ALL EXISTING BOUNDARY, UTILITY, AND TOPOGRAPHIC INFORMATION PROVIDED BY ALL POINT LAND SURVEY LLC ON TOPOGRAPHIC MAP OF UNIT AR-52R, TELLURIDE MOUNTAIN VILLAGE DATED 8/5/2020. BENCHMARK ON LOT AR-52R WITH ASSUMED ELEVATION OF 9081.45. CONTACT TOM CLARK AT (970) 708-9694 FOR MORE BENCHMARK INFORMATION. SOME OF THE UTILITY SERVICES LOCATIONS SHOWN ON THIS PLAN ARE FROM MAPPING AS-BUILT INFORMATION ONLY AND NOT CONFIRMED.
3. MAXIMUM SLOPE GRADING TO BE 3(HORIZONTAL):1(VERTICAL). ANY SLOPE OVER 3:1 TO BE CONFIRMED BY GEOTECH ENGINEER.
4. ALL RETAINING WALL HEIGHTS ARE FINISHED GRADE TO FINISHED GRADE (RETAINED HEIGHT) AND DO NOT INCLUDE FOUNDATIONS OR CAPS.
5. RETAINING WALLS WITH PEDESTRIAN/VEHICULAR ACCESS REQUIRE HAND RAILS FOR ALL RETAINED HEIGHT AT OR OVER 2.5' (SEE ARCHITECTURAL, STRUCTURAL, AND/OR LANDSCAPE PLANS).

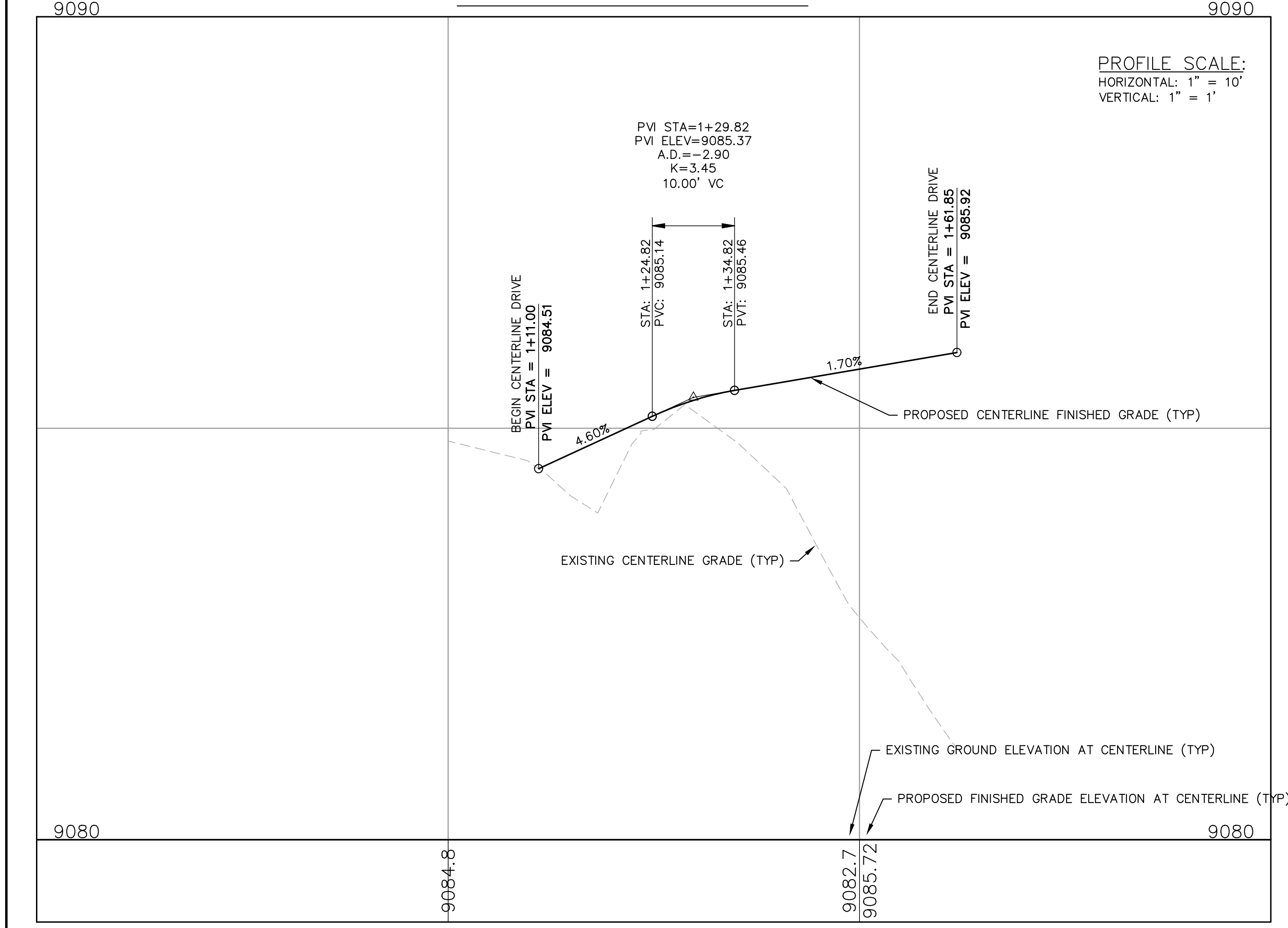
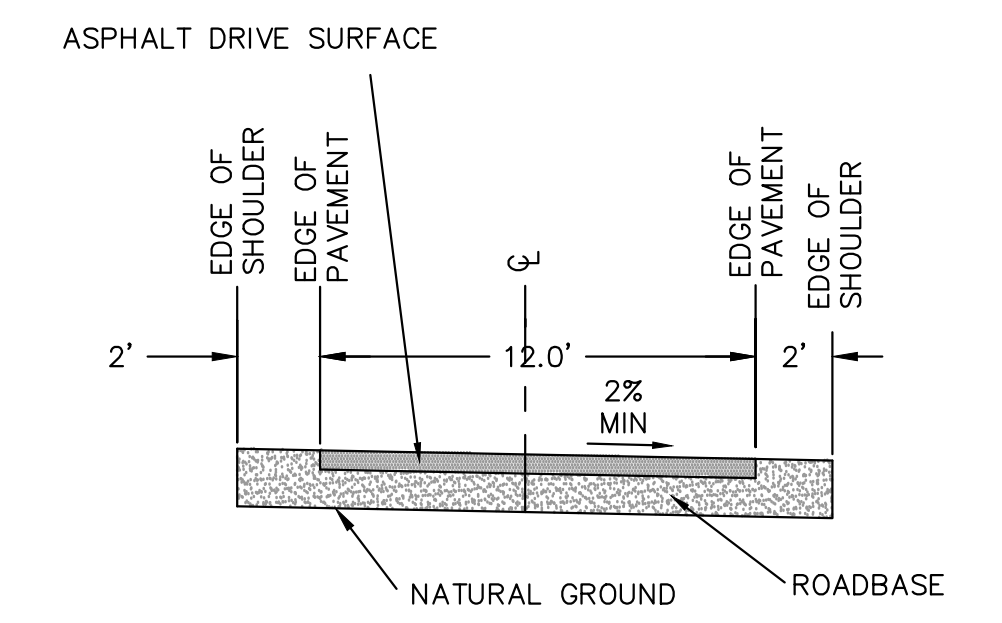
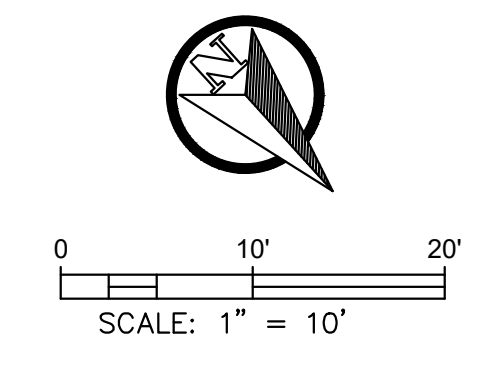

CALL UTILITY NOTIFICATION
CENTER OF COLORADO
1-800-922-1987
OR
811
CALL 2-BUSINESS DAYS IN ADVANCE
BEFORE YOU DIG, GRADE, OR
EXCAVATE FOR THE MARKING OF
UNDERGROUND MEMBER UTILITIES.



THESE DRB PLANNING DOCUMENTS WERE PREPARED BY ME AND UNDER MY DIRECT SUPERVISION ON BEHALF OF ALPINE LAND CONSULTING, LLC FOR ADAMS WAY, LLC AND INCLUDES PRELIMINARY DRB PLANNING DESIGN ONLY, AND DOES NOT INCLUDE ANY OTHER PLANNING OR ENGINEERING.

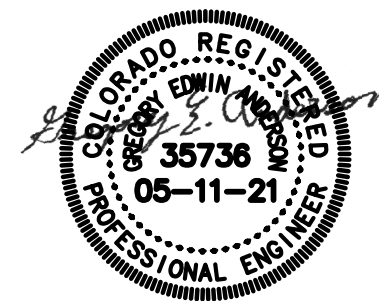

GREGORY E. ANDERSON
COLORADO PROFESSIONAL ENGINEER
REGISTRATION NO. 35736

AR-52R TOWN OF MOUNTAIN VILLAGE
DRB GRADING PLAN

CLIENT:
ADAMS WAY LLC
PO BOX 22183
TELLURIDE, CO 81435

DATE: MAY 11, 2021

PROJECT #: 2021002

PROJECT MANAGER: GEA
DRAWN BY: ADM

SHEET #:

4 OF 4

NO.	REVISIONS	DATE

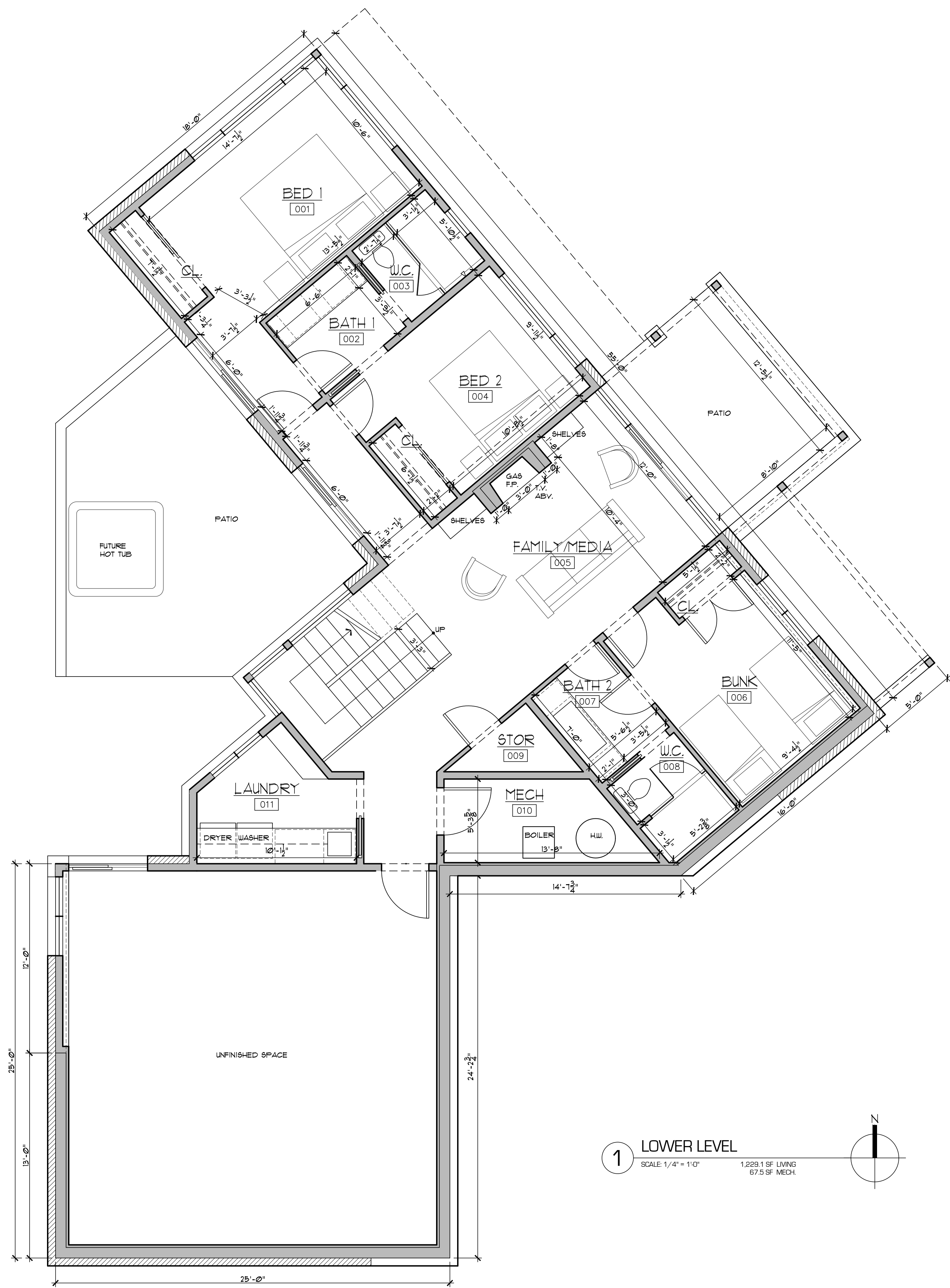

1 LOWER LEVEL
 SCALE 1/4" = 1'-0"
 1,229.1 SF LIVING
 67.5 SF MECH.

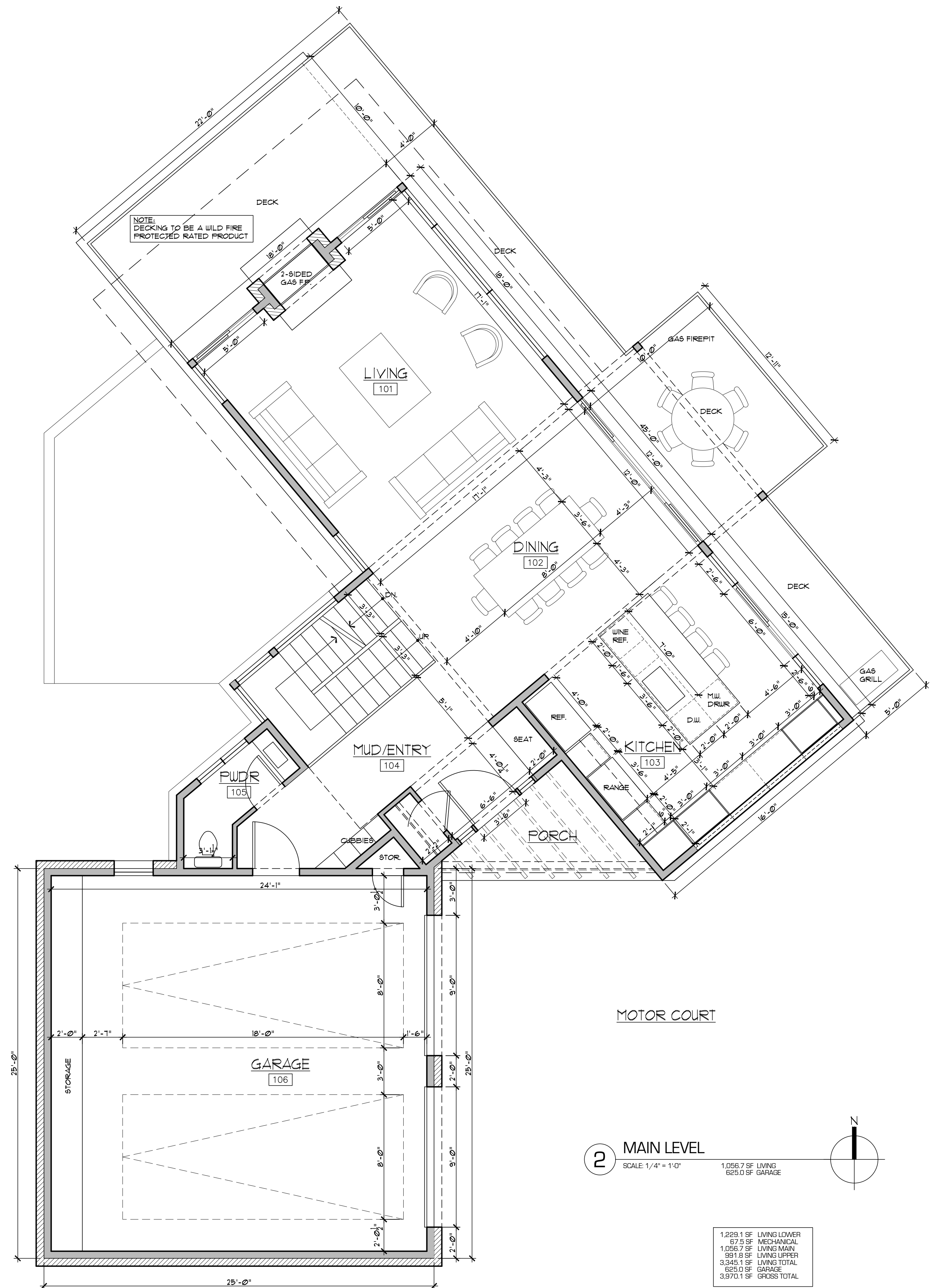
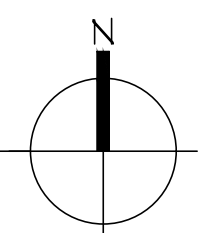

2 MAIN LEVEL
 SCALE 1/4" = 1'-0"
 1,056.7 SF LIVING
 625.0 SF GARAGE

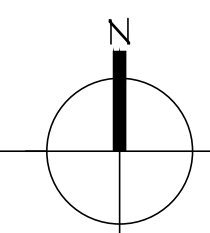

1,229.1 SF	LIVING LOWER
67.5 SF	MECHANICAL
1,056.7 SF	LIVING MAIN
991.8 SF	LIVING UPPER
3,345.1 SF	LIVING TOTAL
625.0 SF	GARAGE
3,970.1 SF	GROSS TOTAL

FOR REVIEW ONLY NOT FOR CONSTRUCTION

DATE: MAY 24, 2021
 ISSUED FOR: REVIEW SET
 SHEET NUMBER: A3-1
 FLOOR PLAN

PROJECT: AR-52 RESIDENCE
 LOCATION: AR-52 123 ADAMS WAY MOUNTAIN VILLAGE SAN MIGUEL COUNTY

REVISIONS:

COPYRIGHT 2021

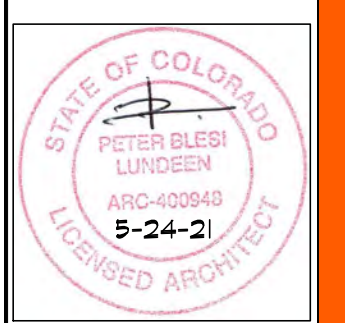

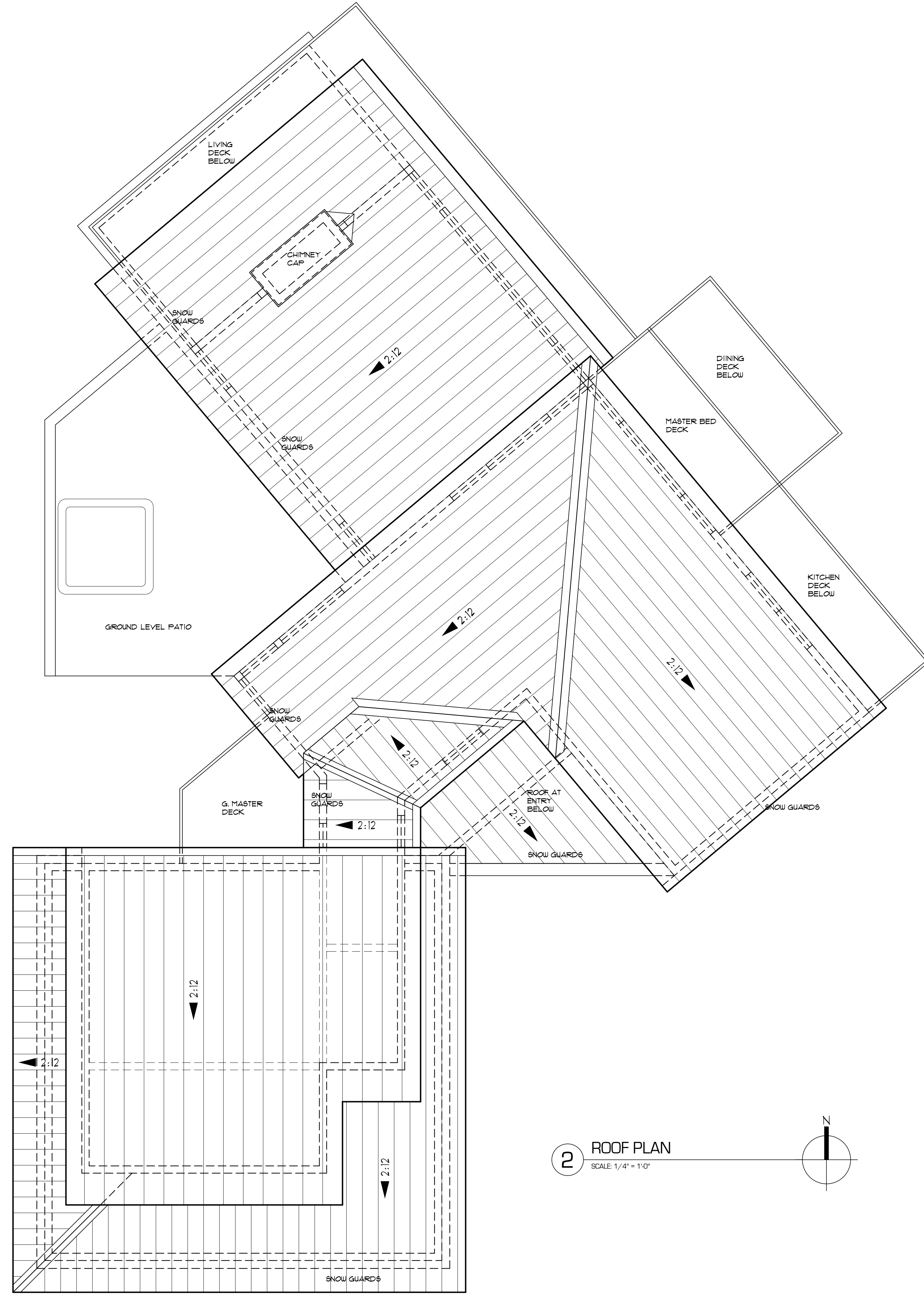
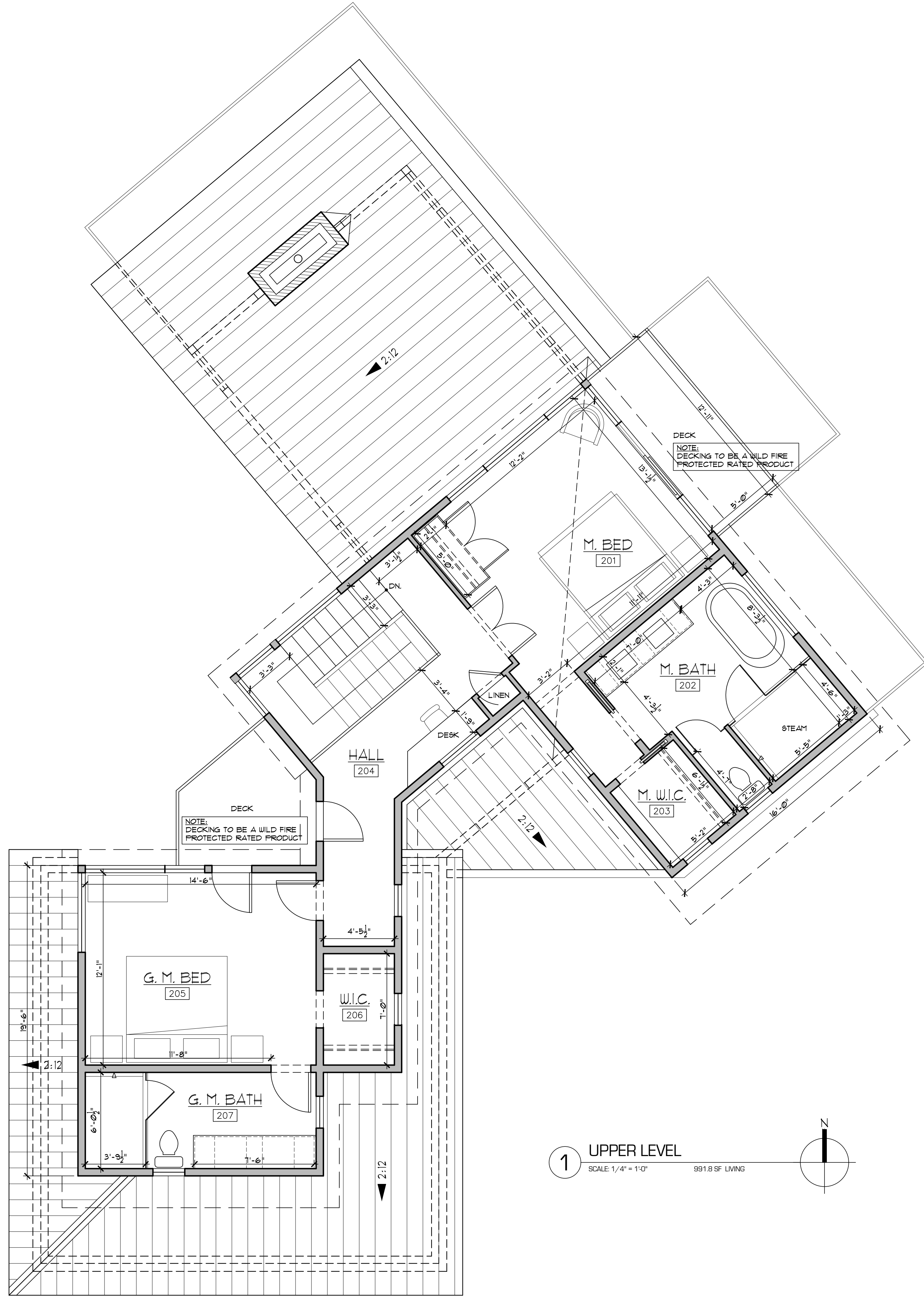

FOR REVIEW ONLY NOT FOR CONSTRUCTION

DATE: MAY 24, 2021
ISSUED FOR: REVIEW SET

PROJECT: #2014

AR-52 RESIDENCE

COPYRIGHT 2021

REVISIONS:

LOCATION: AR-52 123 ADAMS WAY MOUNTAIN VILLAGE SAN MIGUEL COUNTY

SHEET NUMBER: A3-2
FLOOR & ROOF PLANS

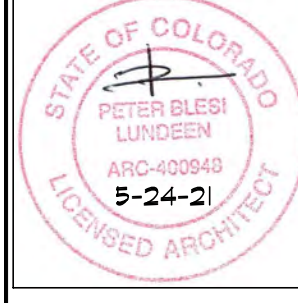

GARAGE SOUTH ELEVATION
MAX. BUILDING HEIGHT = 21'-4 1/8"

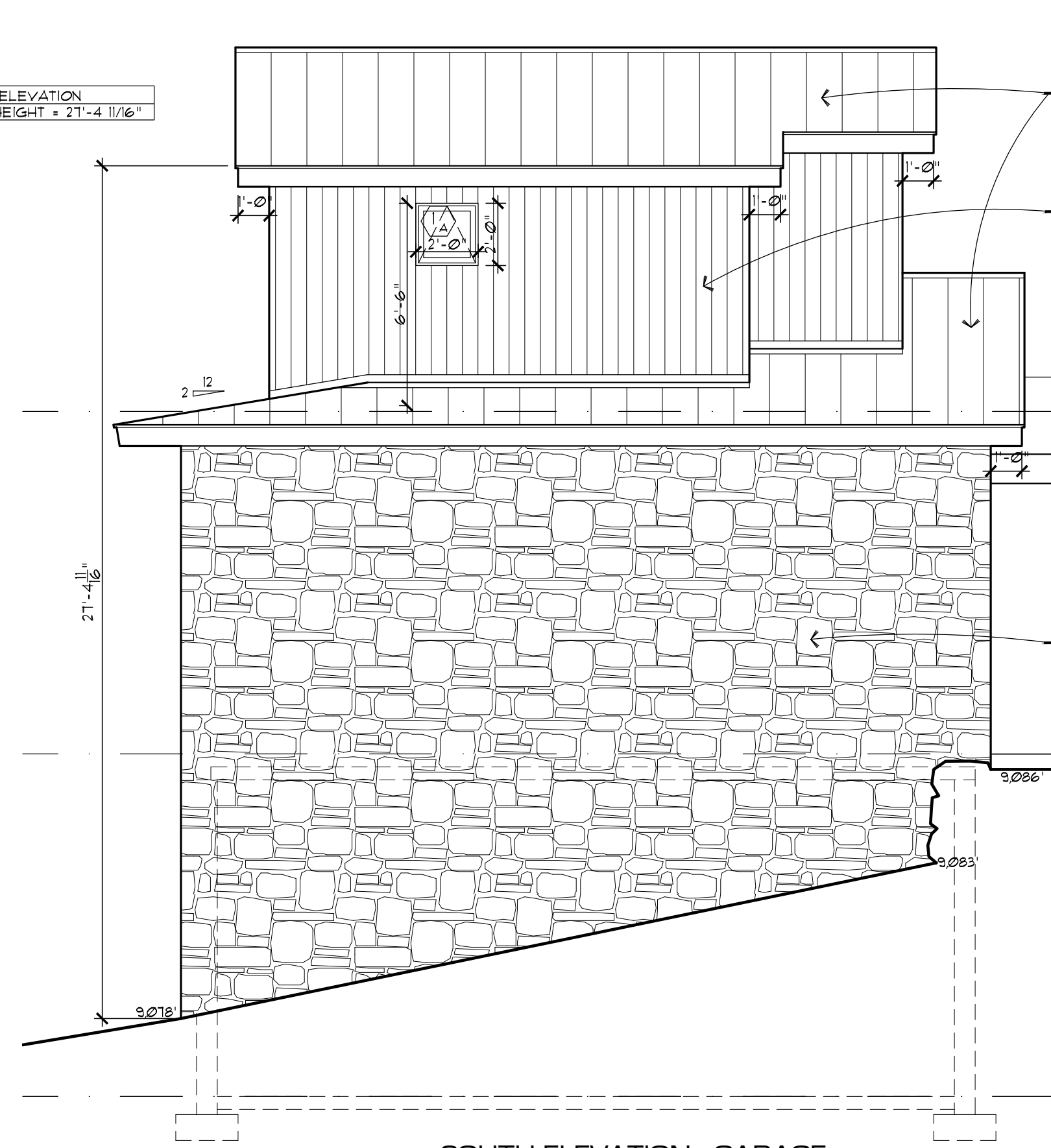

A SOUTH ELEVATION - GARAGE
SCALE: 1/4" = 1'-0"

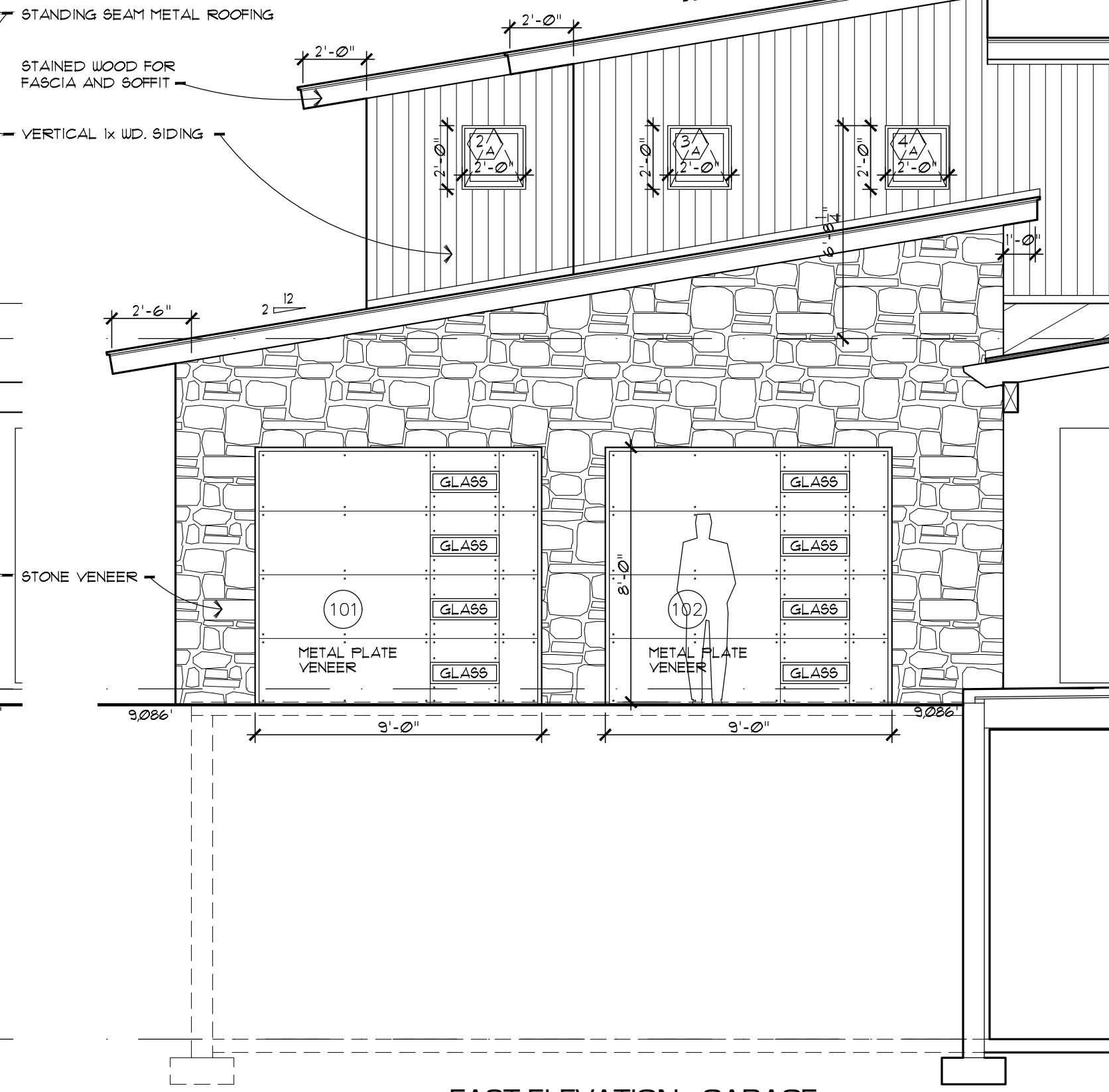

B EAST ELEVATION - GARAGE
SCALE: 1/4" = 1'-0"

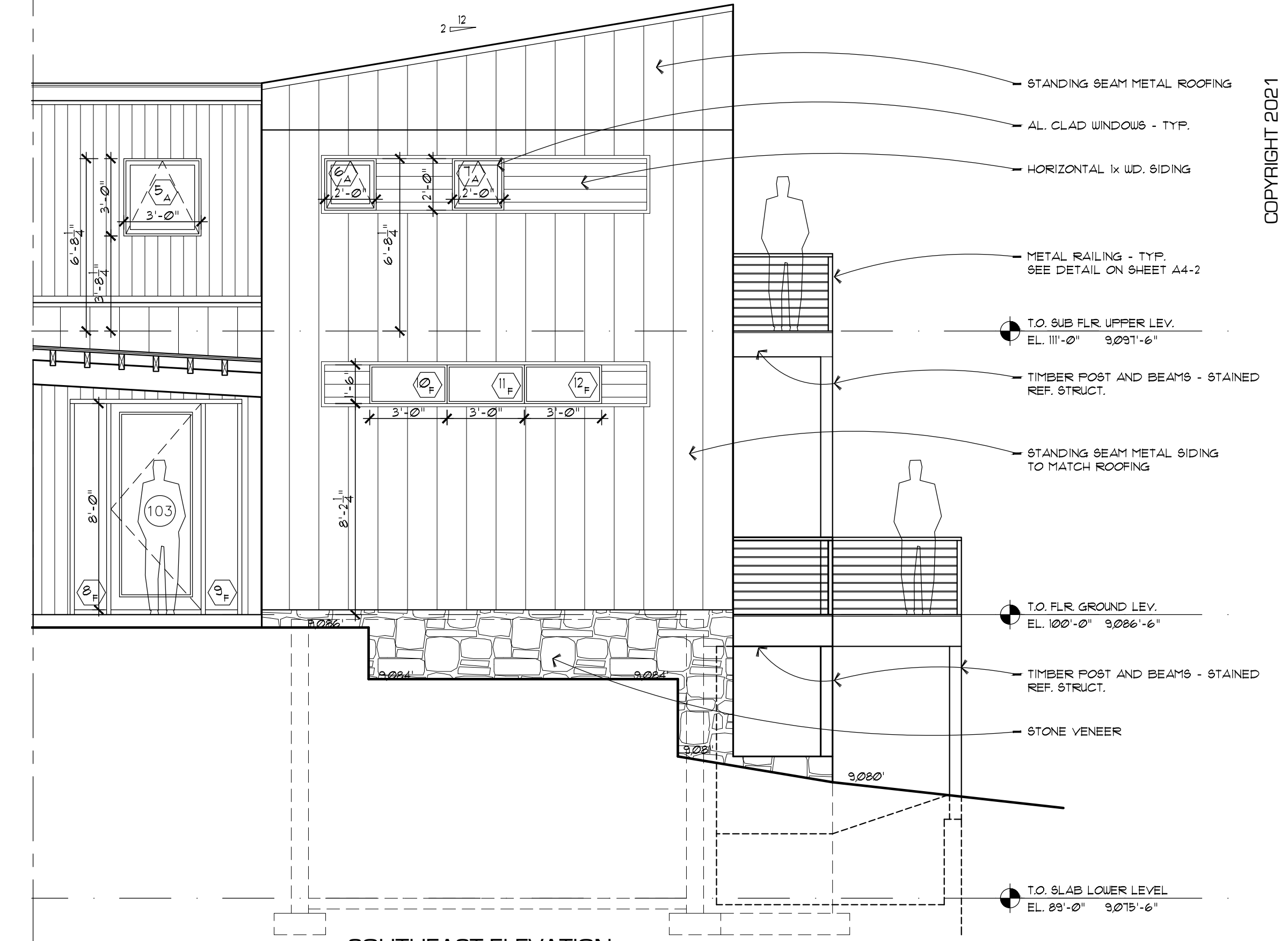

C SOUTHEAST ELEVATION
SCALE: 1/4" = 1'-0"

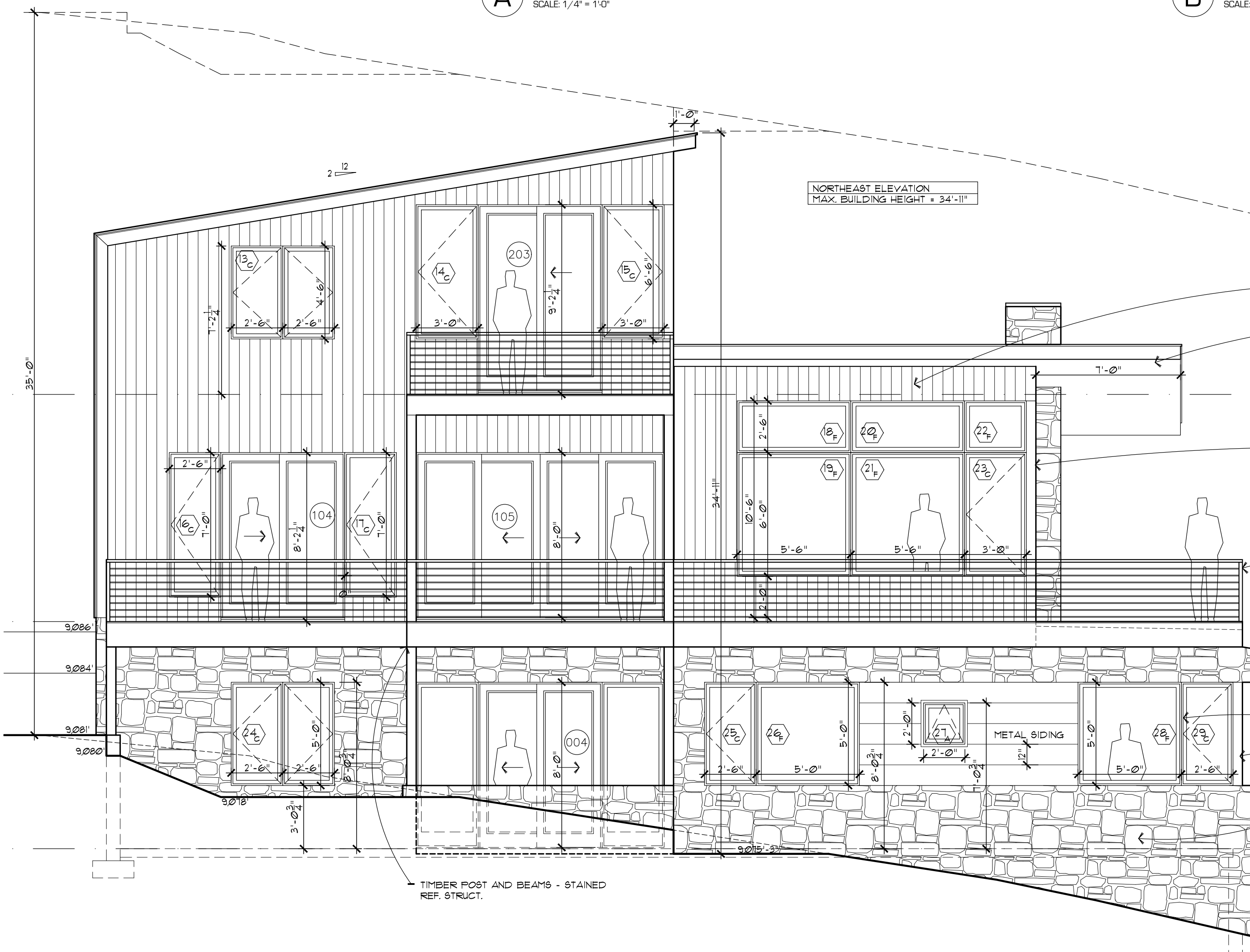

D NORTHEAST ELEVATION
SCALE: 1/4" = 1'-0"

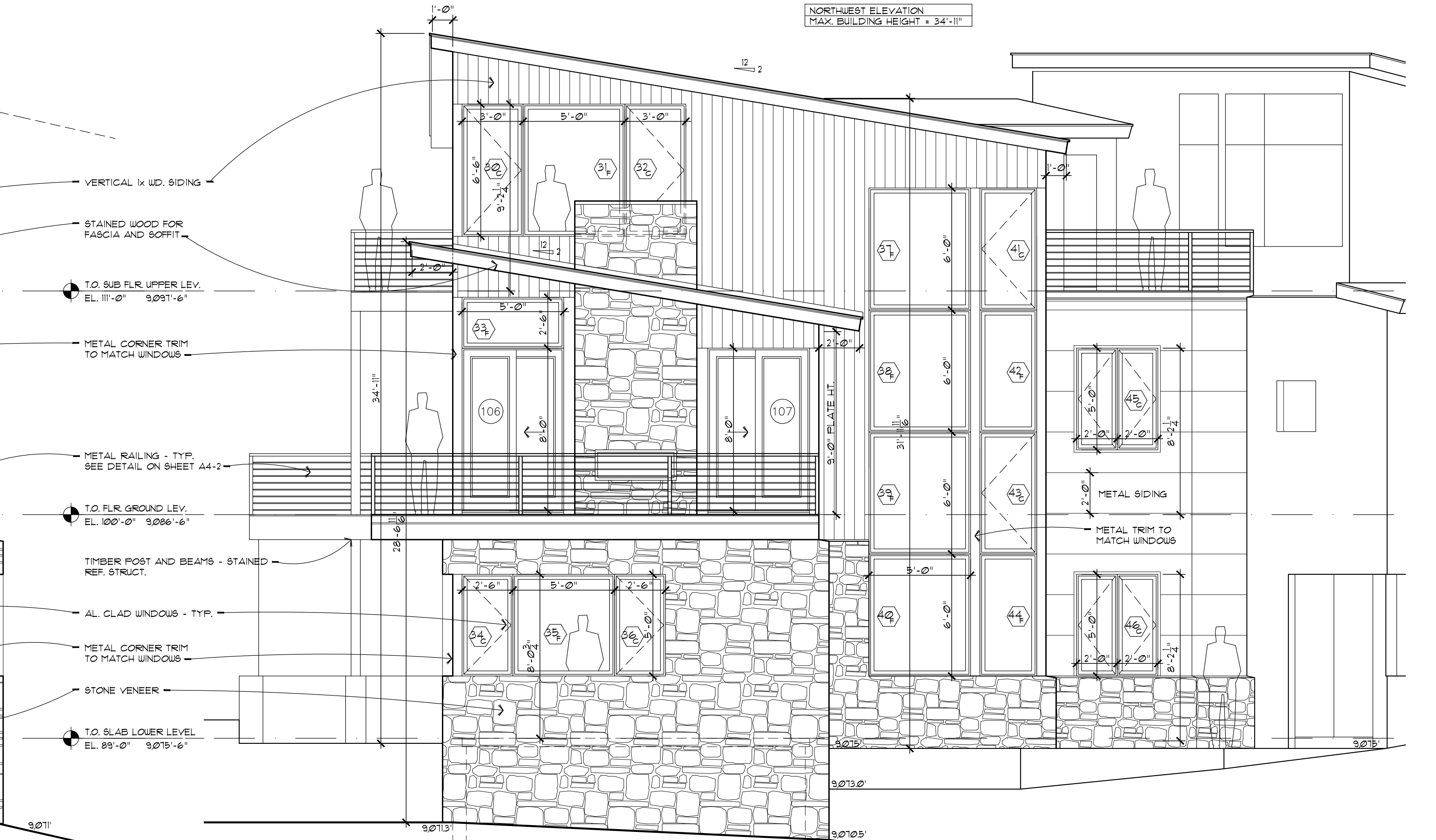

E NORTHWEST ELEVATION
SCALE: 1/4" = 1'-0"

COPYRIGHT 2021

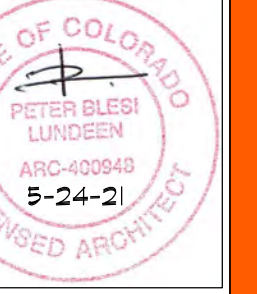

REVISIONS:

AR-52 RESIDENCE

PROJECT: #2014

DATE: MAY 24, 2021
ISSUED FOR: REVIEW SET

SHEET NUMBER: A4-1

LOCATION: AR-52 123 ADAMS WAY MOUNTAIN VILLAGE SAN MIGUEL COUNTY

EXTERIOR ELEVATIONS

FUSE architecture + interior

220 East Colorado Ave., Suite 218 P.O.Box 3984 Telluride CO 81435. Office: 970-728-0841

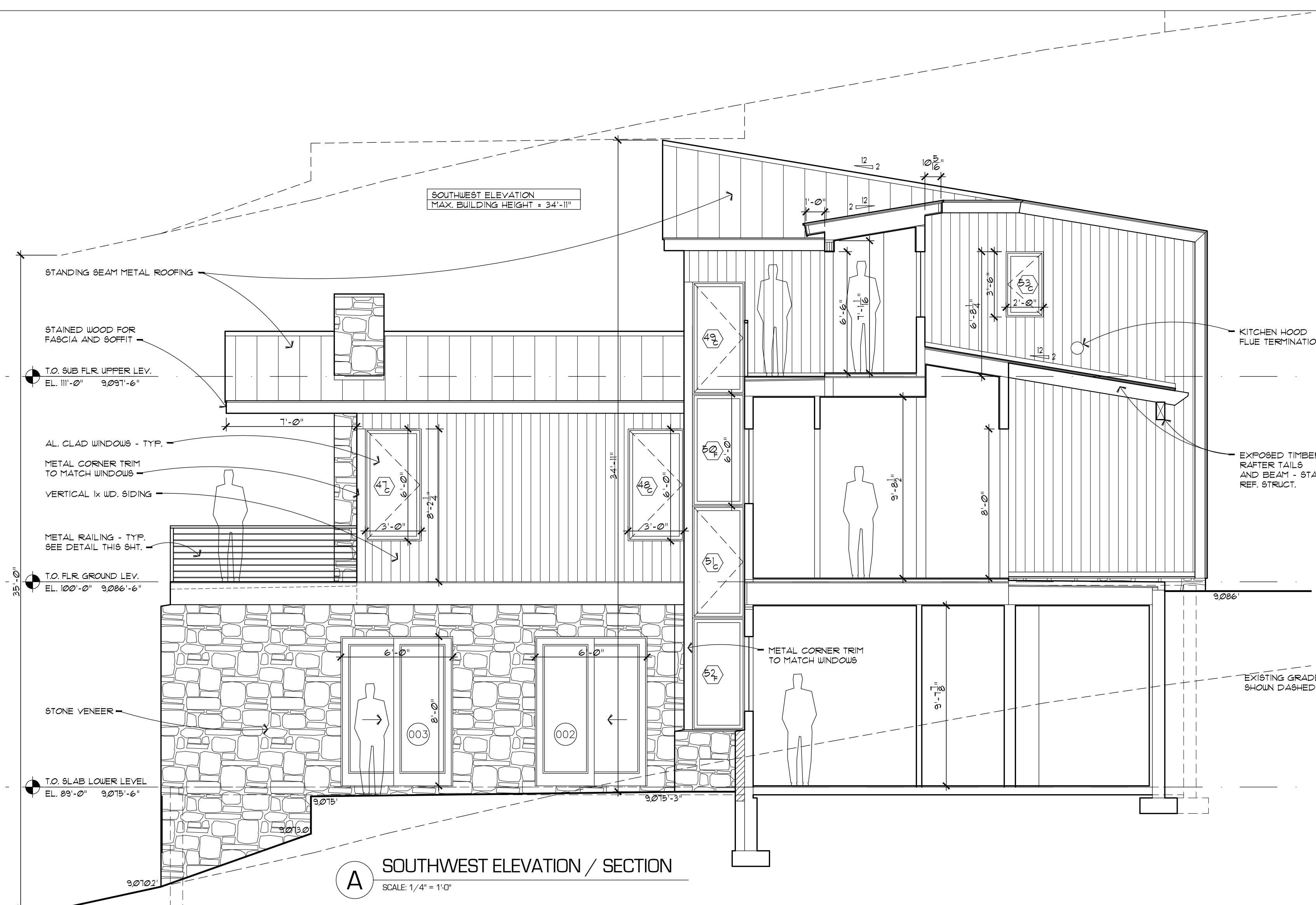

A SOUTHWEST ELEVATION / SECTION
SCALE 1/4" = 1'-0"

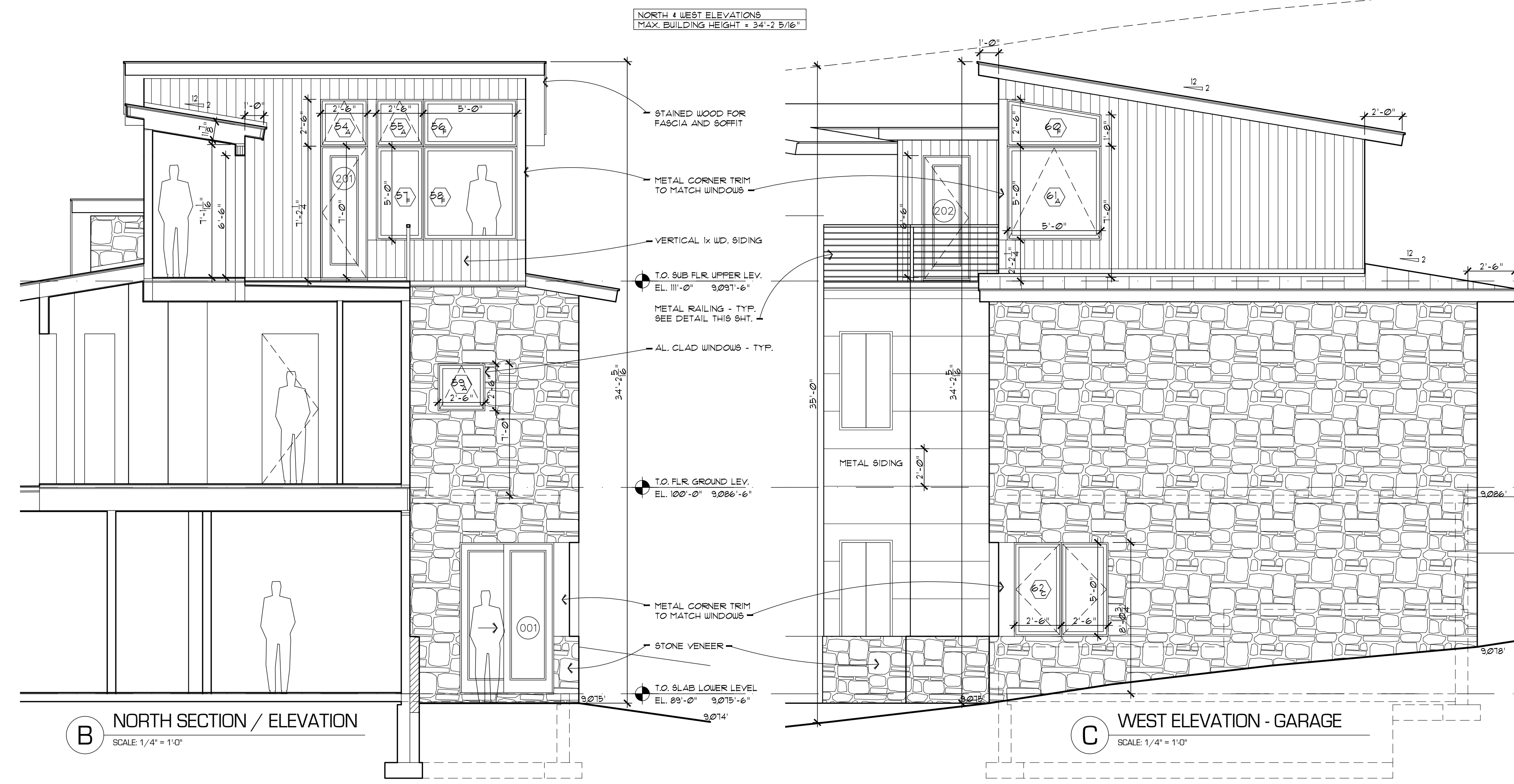

B NORTH SECTION / ELEVATION
SCALE 1/4" = 1'-0"

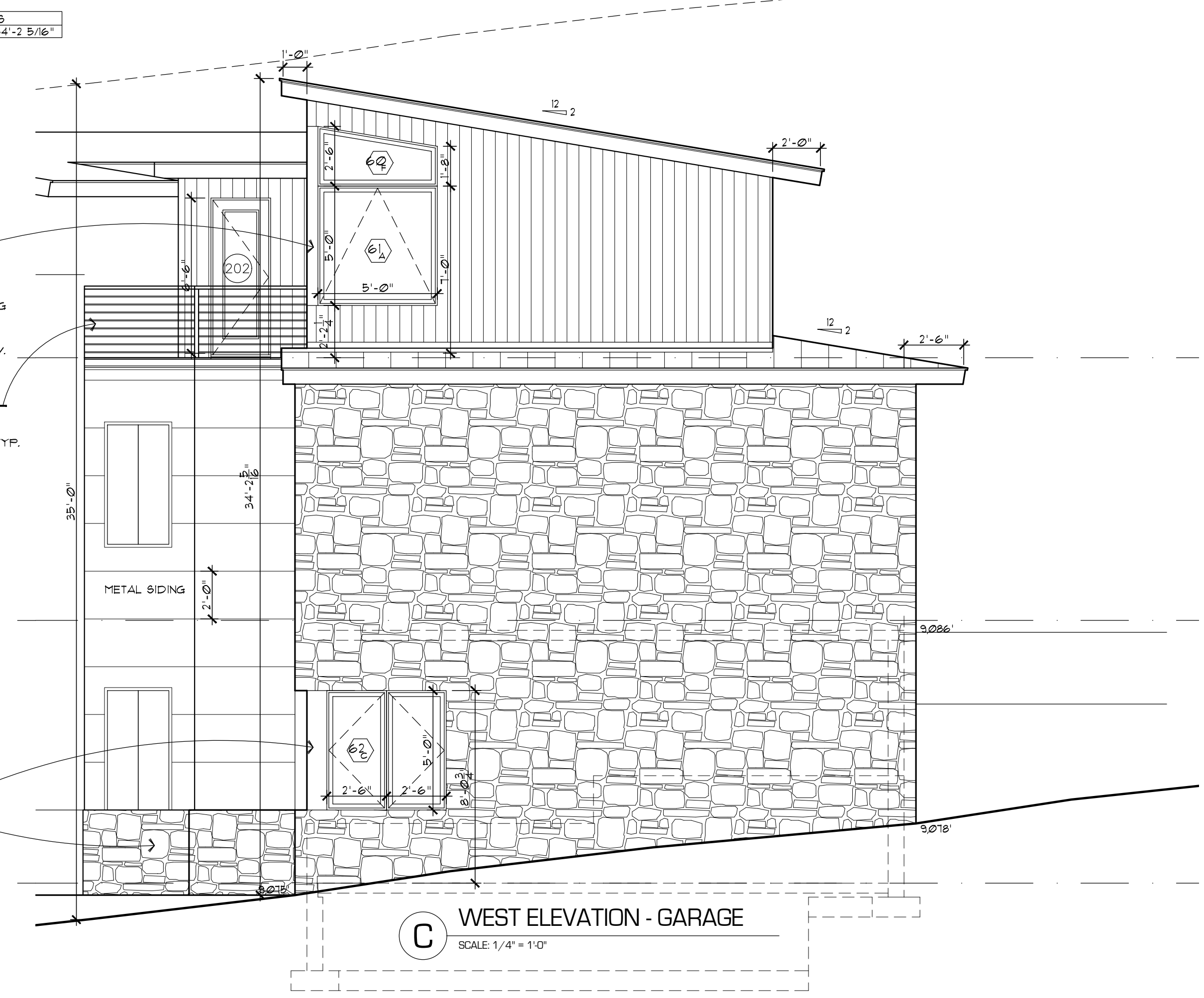

C WEST ELEVATION - GARAGE
SCALE 1/4" = 1'-0"

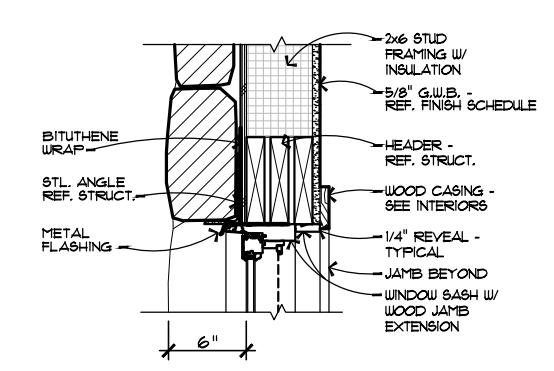

1 WINDOW HEAD (DOOR SIM.) AT STONE VENEER

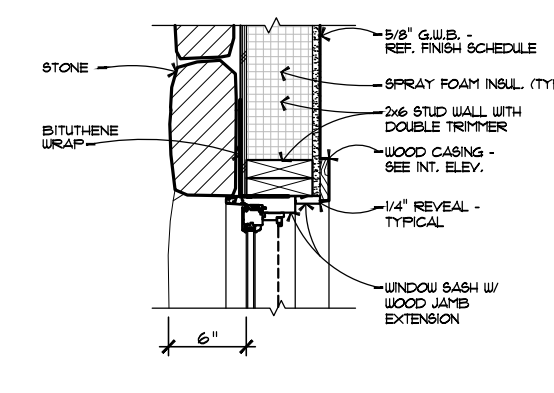

2 WINDOW JAMB (DOOR SIM.) AT STONE VENEER

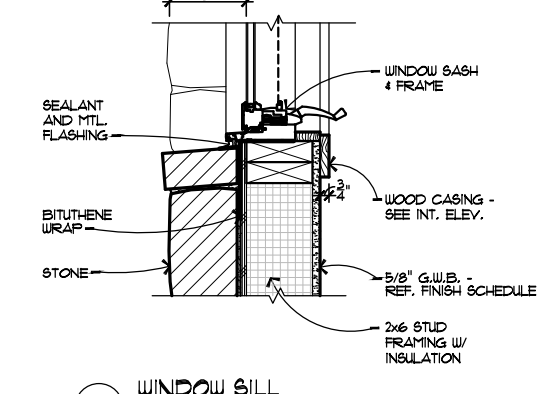

3 WINDOW SILL AT STONE VENEER

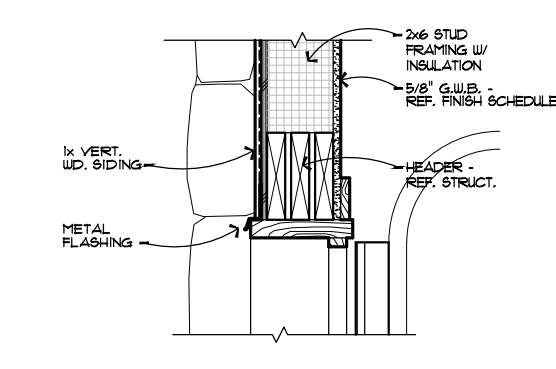

4 GARAGE DOOR HEAD AT STONE VENEER

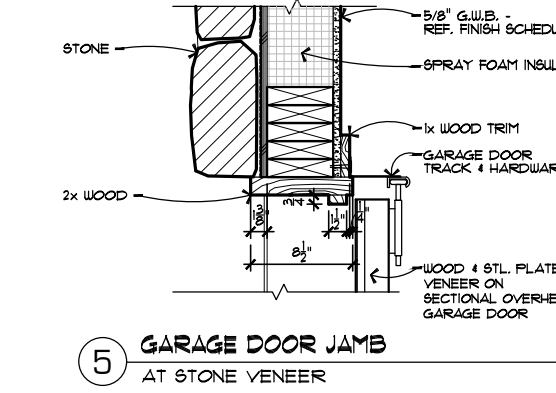

5 GARAGE DOOR JAMB AT STONE VENEER

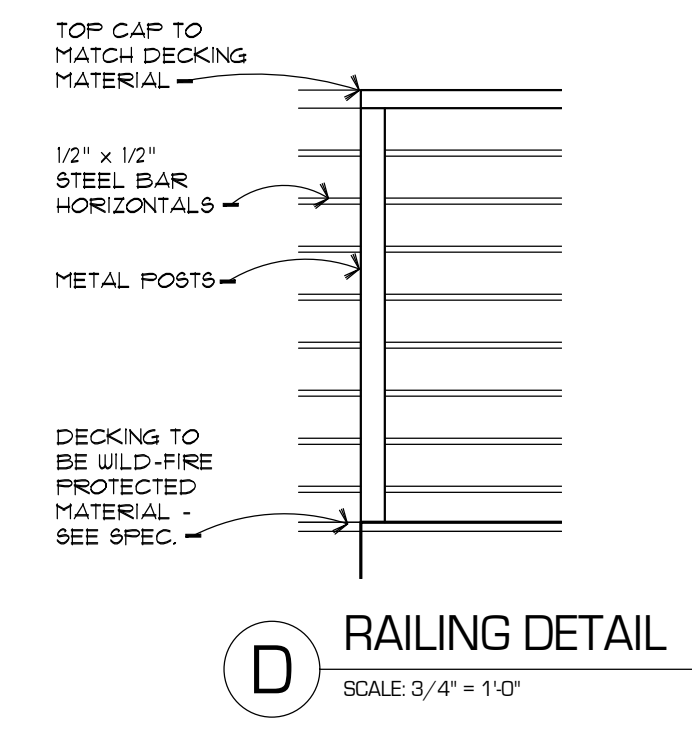

D RAILING DETAIL
SCALE 3/4" = 1'-0"

COPYRIGHT 2021

REVISIONS:

AR-52 RESIDENCE

PROJECT: #2014

DATE: MAY 24, 2021
ISSUED FOR: REVIEW SET

SHEET NUMBER: A4-2
EXTERIOR ELEVATIONS

LOCATION: AR-52 123 ADAMS WAY MOUNTAIN VILLAGE SAN MIGUEL COUNTY

FUSE architecture + interior

220 East Colorado Ave., Suite 218 P.O.Box 3984 Telluride CO 81435. Office: 970-728-0841

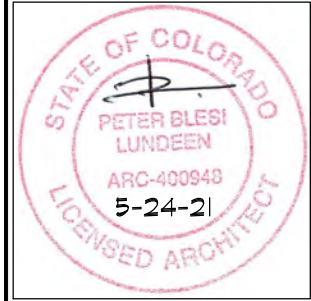

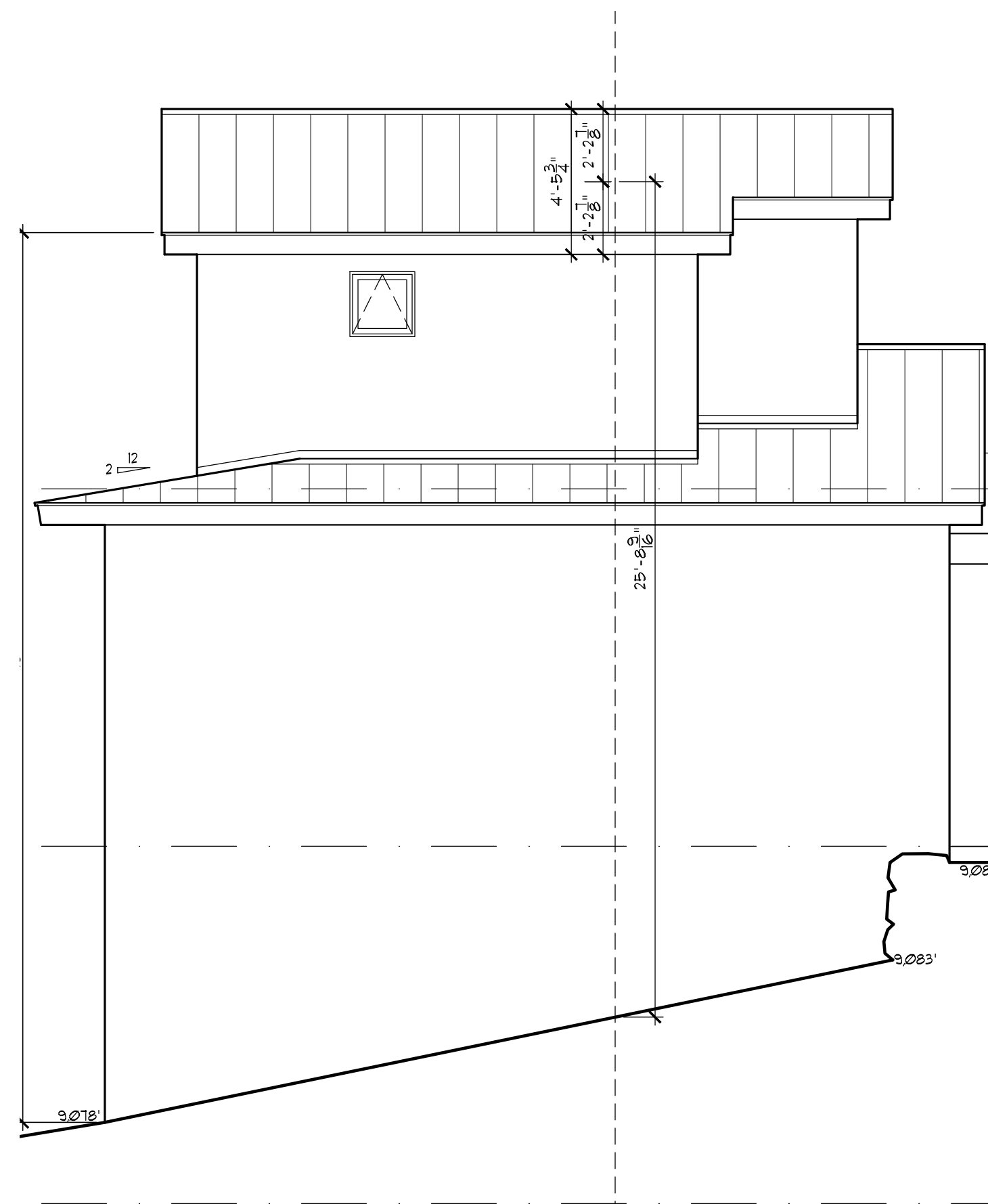

A SOUTH ELEVATION - GARAGE - AVE. HT.
SCALE: 1/4" = 1'-0"

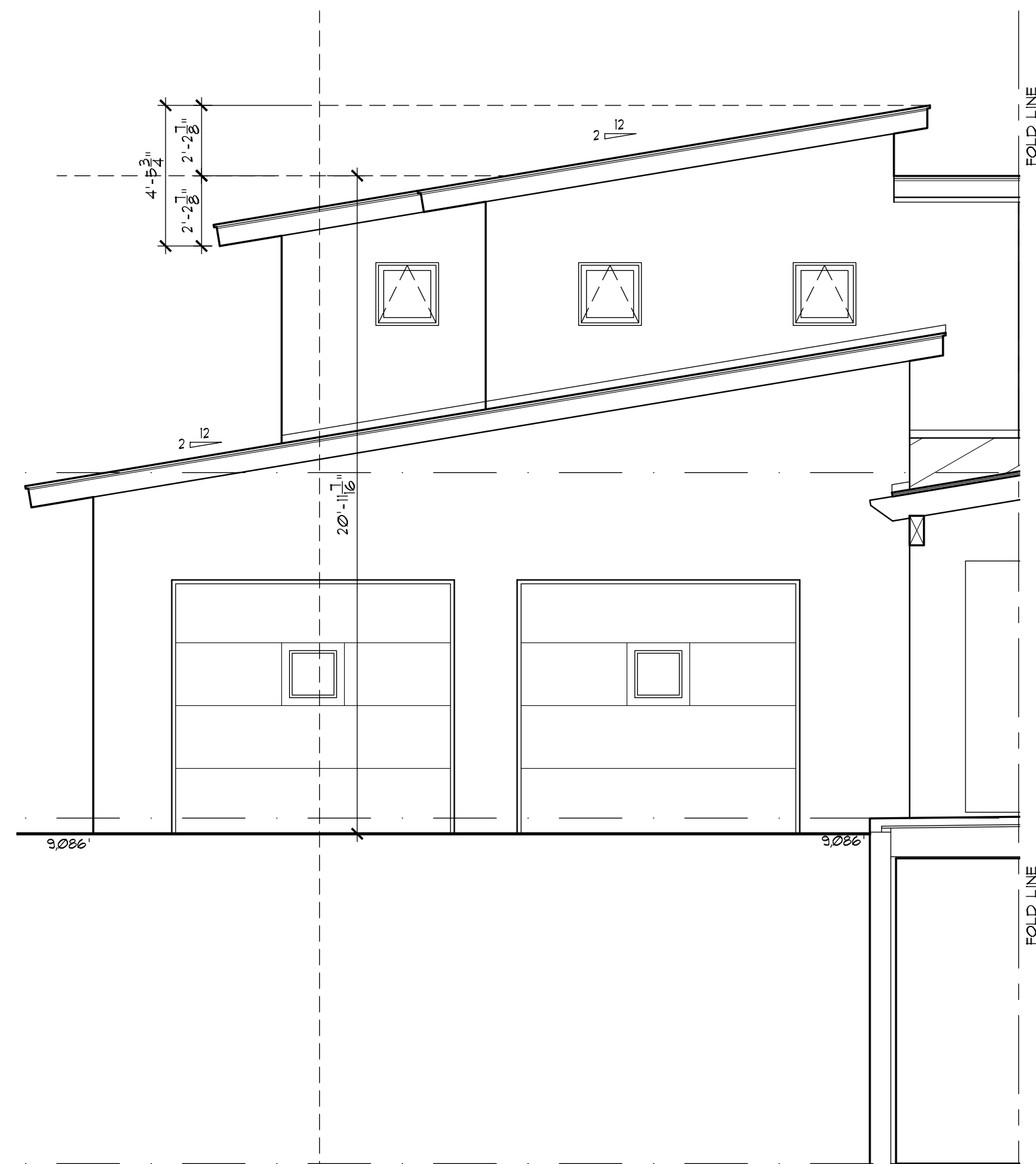

B EAST ELEVATION - GARAGE - AVE. HT.
SCALE: 1/4" = 1'-0"

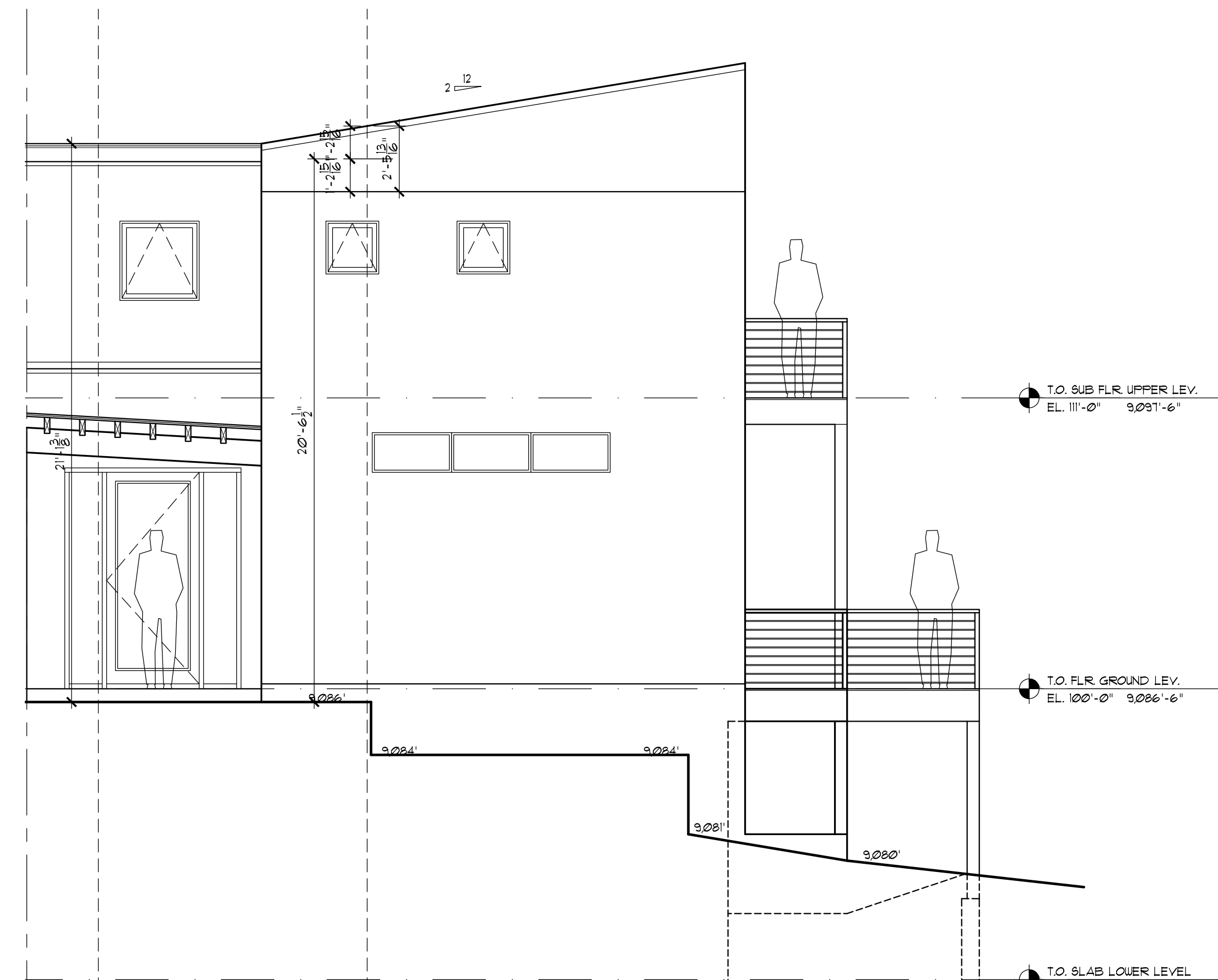

C SOUTHEAST ELEVATION - AVE HT.
SCALE: 1/4" = 1'-0"



D NORTHEAST ELEVATION - AVE. HT.
SCALE: 1/4" = 1'-0"

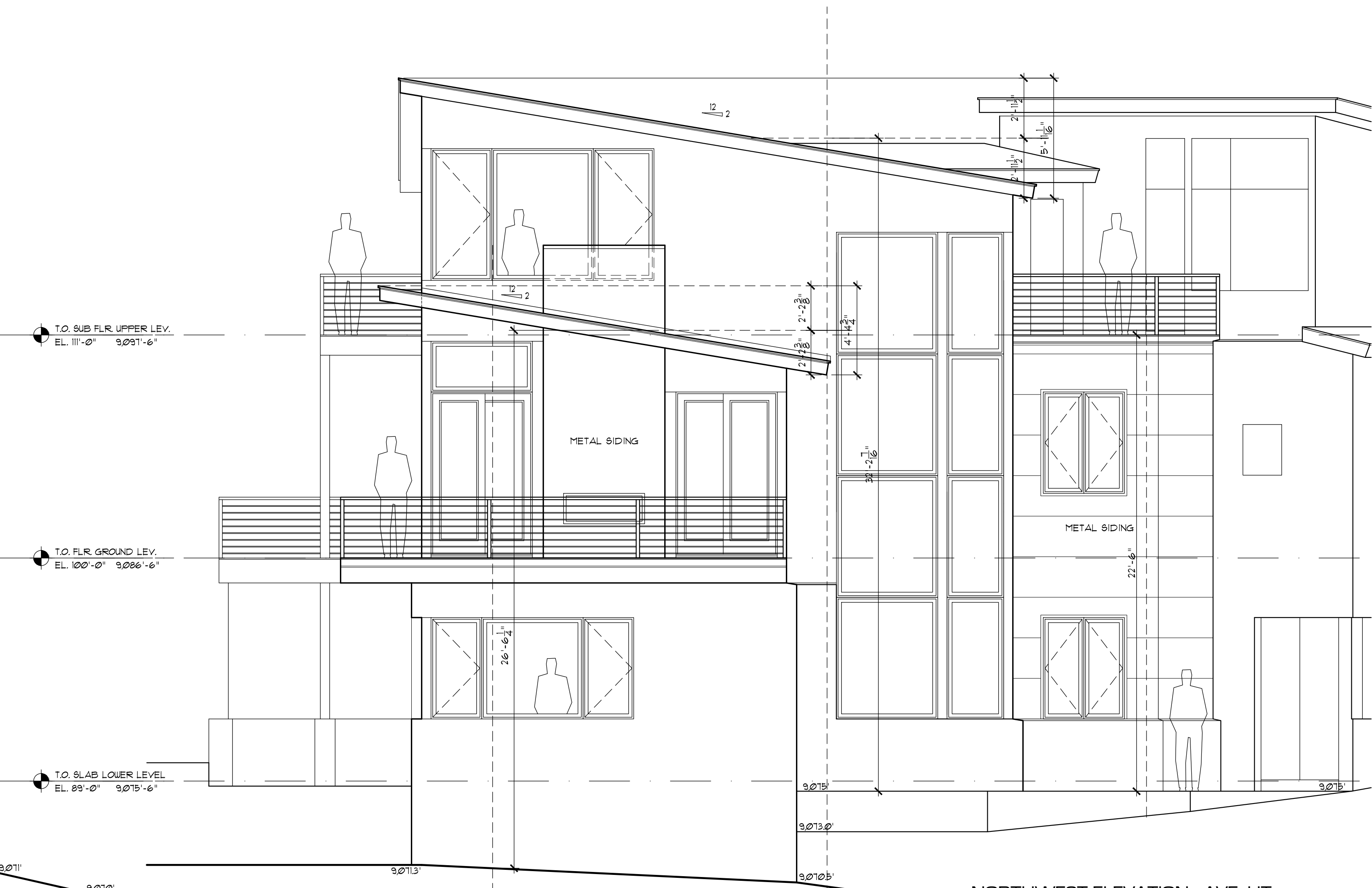

E NORTHWEST ELEVATION - AVE. HT.
SCALE: 1/4" = 1'-0"

COPYRIGHT 2021

REVISIONS:

AR-52 RESIDENCE

PROJECT: #2014

DATE: MAY 24, 2021
ISSUED FOR: REVIEW SET

AR-52 123 ADAMS WAY MOUNTAIN VILLAGE SAN MIGUEL COUNTY

SHEET NUMBER: A4-3
EXT. ELEVS - AVE HT. CALCS

FUSE architecture + interior

220 East Colorado Ave., Suite 218 P.O.Box 3984 Telluride CO 81435. Office: 970-728-0841





A SOUTHWEST ELEVATION / SECTION - AVE. HT.
SCALE: 1/4" = 1'-0"

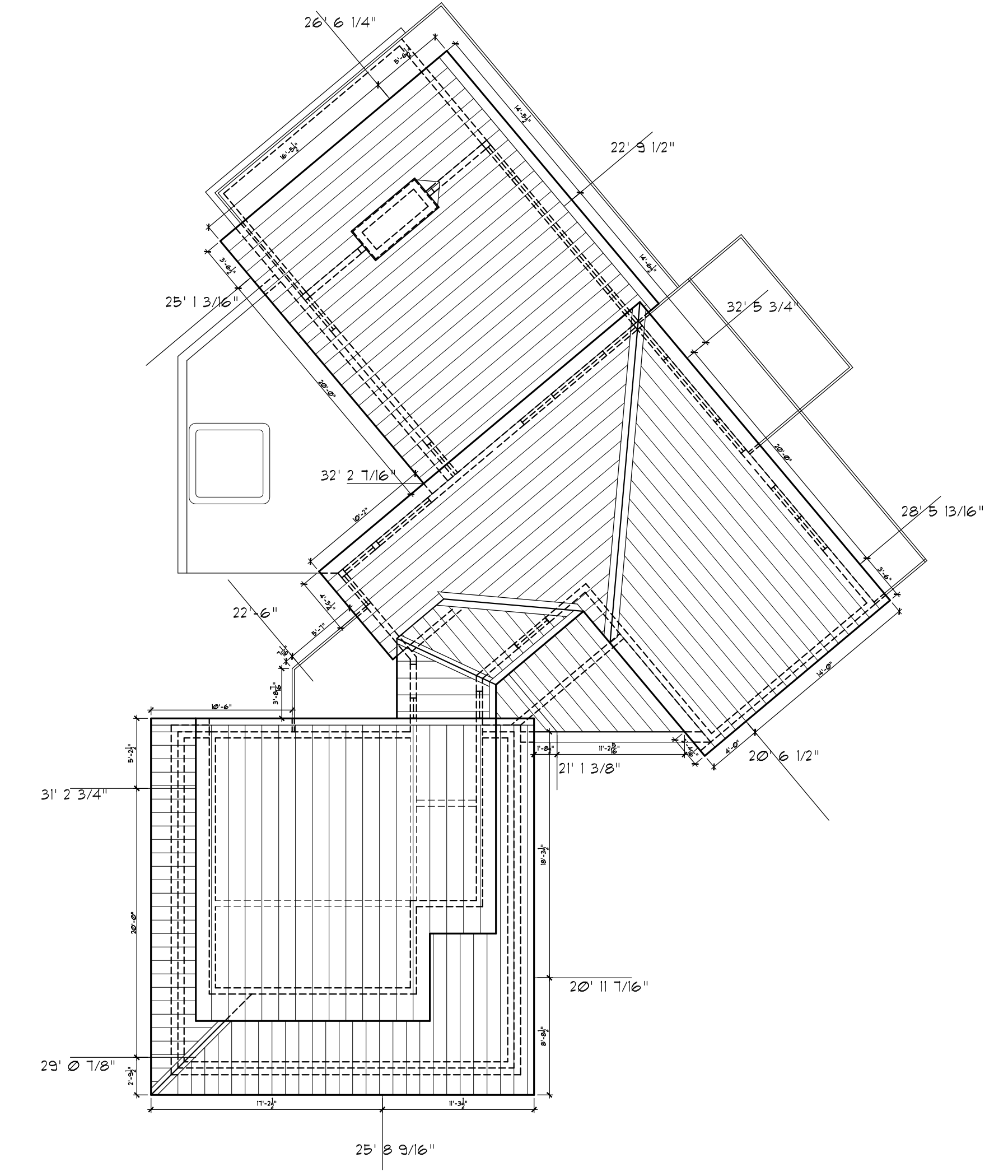

Ave Roof Height	feet	inches	inch in feet	total in feet
20'-11 7/16"	20	11.5	0.96	20.96
21'-1 3/8"	21	1.5	0.13	21.13
20'-6 1/2"	20	6.5	0.54	20.54
28'-5 13/16"	28	5.75	0.48	28.48
32'-5 3/4"	32	5.75	0.48	32.48
22'-9 1/2"	22	9.5	0.79	22.79
26'-6 1/4"	26	6.25	0.52	26.52
25'-1 3/16"	25	1.25	0.10	25.10
32'-2 7/16"	32	2.5	0.21	32.21
22'-6"	22	6	0.50	22.50
31'-2 3/4"	31	2.75	0.23	31.23
29'-0 7/8"	29	1	0.08	29.08
25'-8 9/16"	25	8.5	0.71	25.71
26'-0 3/4"		ave height		338.73
				26.06

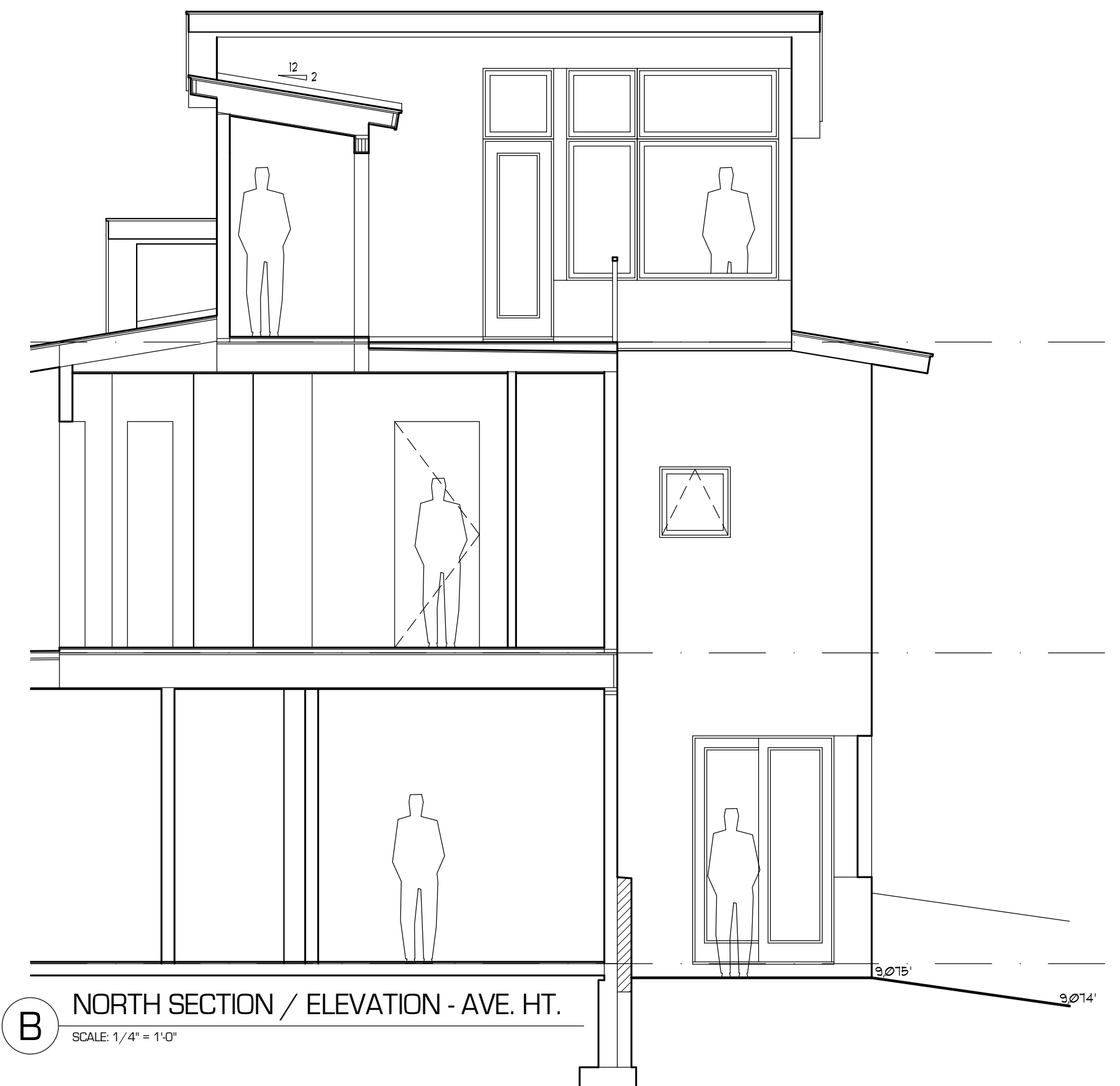

B NORTH SECTION / ELEVATION - AVE. HT.
SCALE: 1/4" = 1'-0"

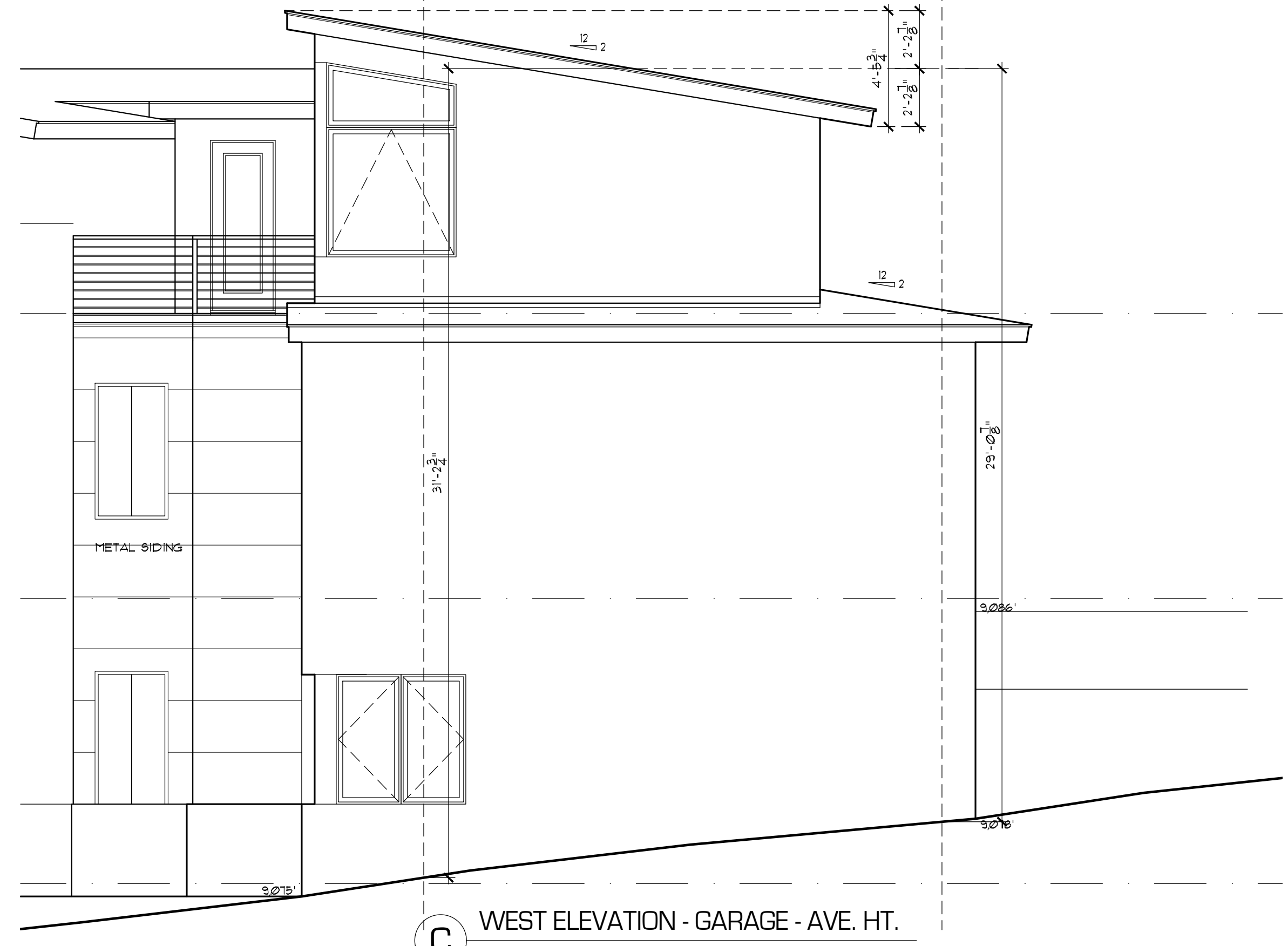

C WEST ELEVATION - GARAGE - AVE. HT.
SCALE: 1/4" = 1'-0"

COPYRIGHT 2021

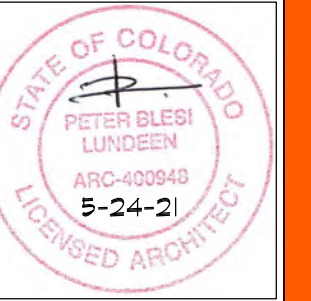

REVISIONS:

AR-52 RESIDENCE

PROJECT: #2014

DATE: MAY 24, 2021
ISSUED FOR: REVIEW SET

SHEET NUMBER: A4-4
EXT. ELEVS - AVE HT. CALCS

AR-52 123 ADAMS WAY MOUNTAIN VILLAGE SAN MIGUEL COUNTY

LOCATION:

EXT. ELEVS - AVE HT. CALCS

220 East Colorado Ave., Suite 218 P.O.Box 3984 Telluride CO 81435. Office: 970-728-0841

FUSE architecture + interior

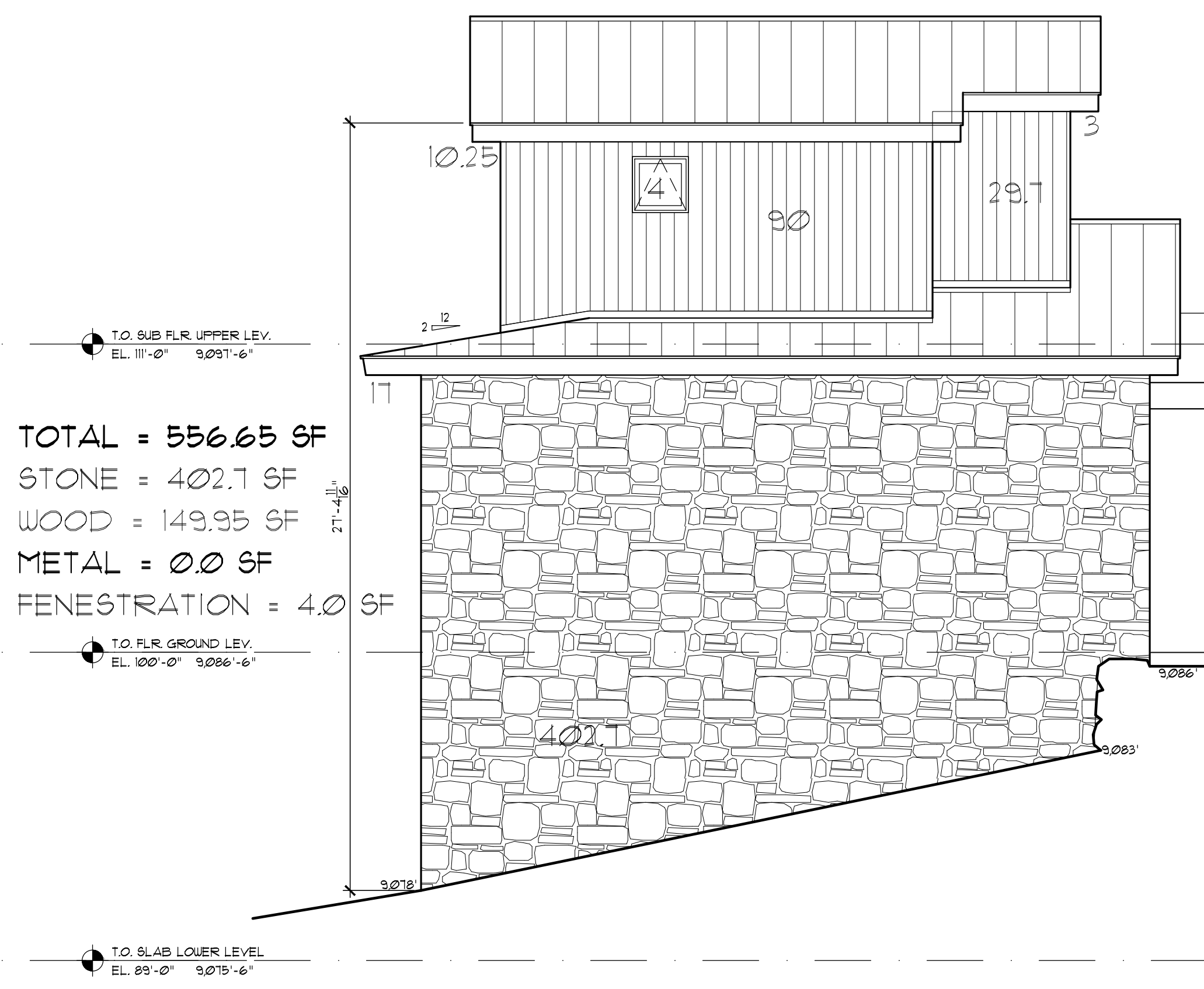

TOTAL = 556.65 SF
 STONE = 402.1 SF
 WOOD = 149.95 SF
 METAL = 0.0 SF
 FENESTRATION = 4.0 SF

A SOUTH ELEVATION - GARAGE - AVE. HT.
 SCALE 1/4" = 1'-0"

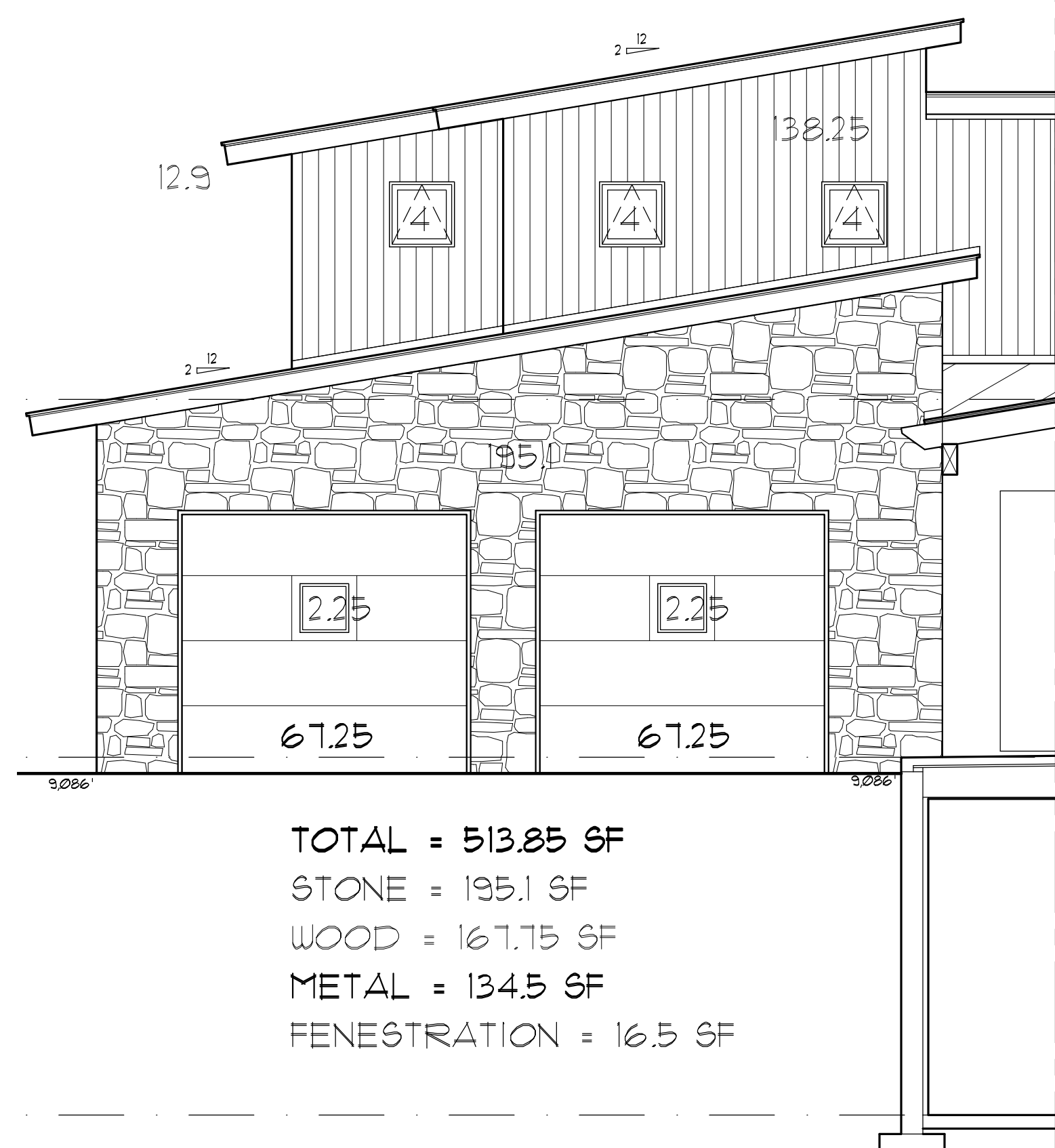

TOTAL = 513.85 SF
 STONE = 195.1 SF
 WOOD = 167.75 SF
 METAL = 134.5 SF
 FENESTRATION = 16.5 SF

B EAST ELEVATION - GARAGE - AVE. HT.
 SCALE 1/4" = 1'-0"

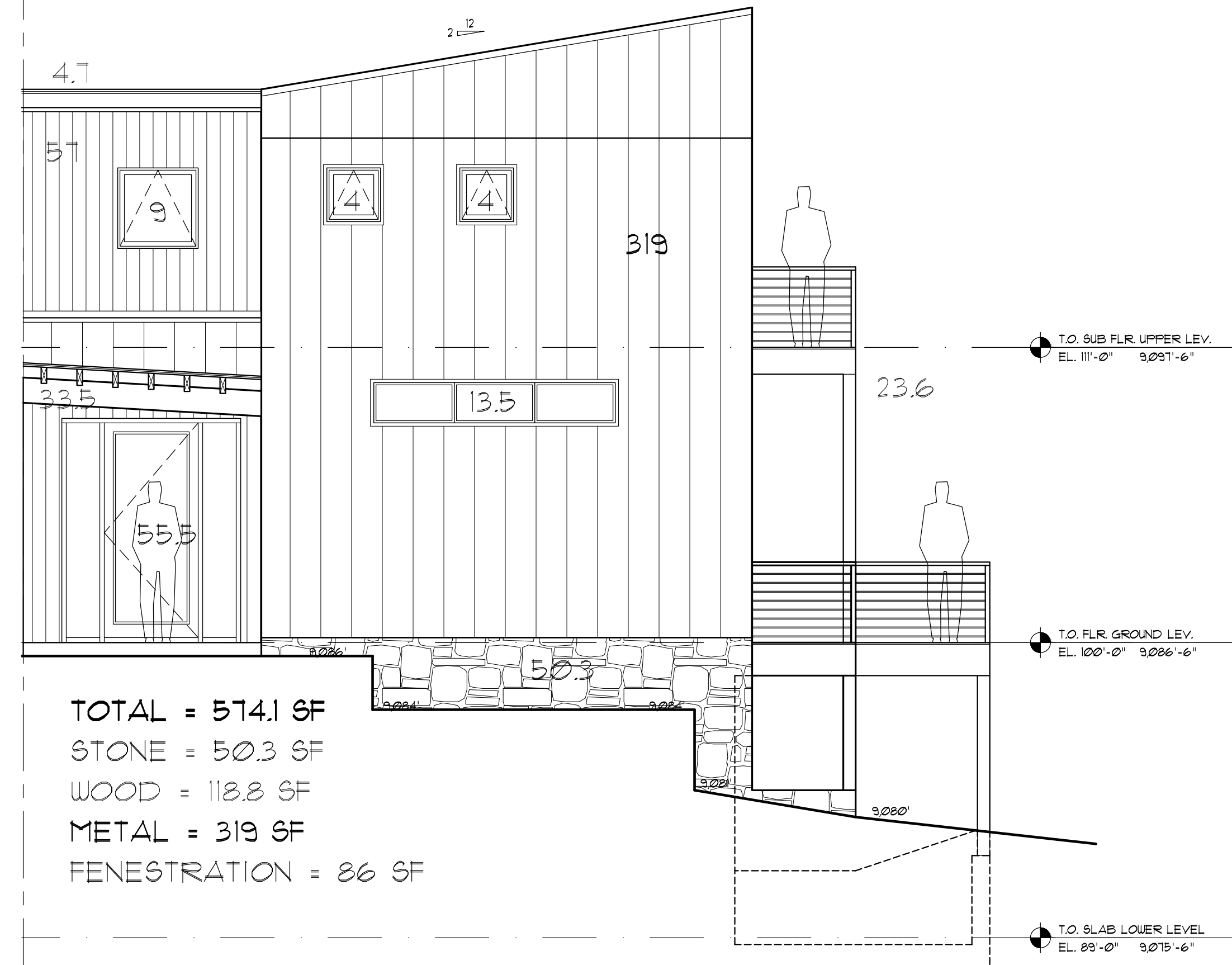

TOTAL = 574.1 SF
 STONE = 50.3 SF
 WOOD = 118.8 SF
 METAL = 319 SF
 FENESTRATION = 86 SF

C SOUTHEAST ELEVATION - AVE. HT.
 SCALE 1/4" = 1'-0"

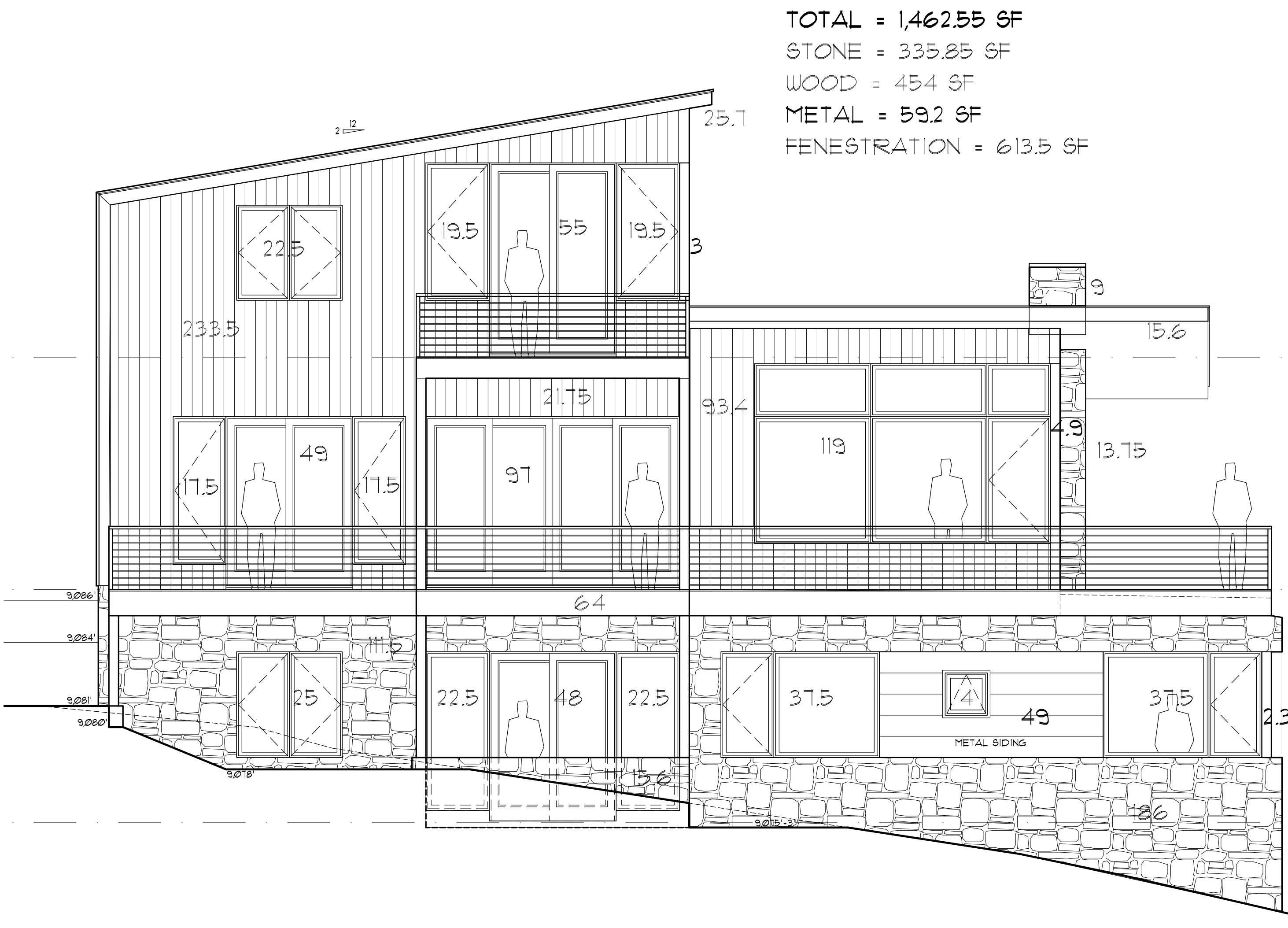

TOTAL = 1,462.55 SF
 STONE = 335.85 SF
 WOOD = 454 SF
 METAL = 59.2 SF
 FENESTRATION = 613.5 SF

D NORTHEAST ELEVATION - AVE. HT.
 SCALE 1/4" = 1'-0"

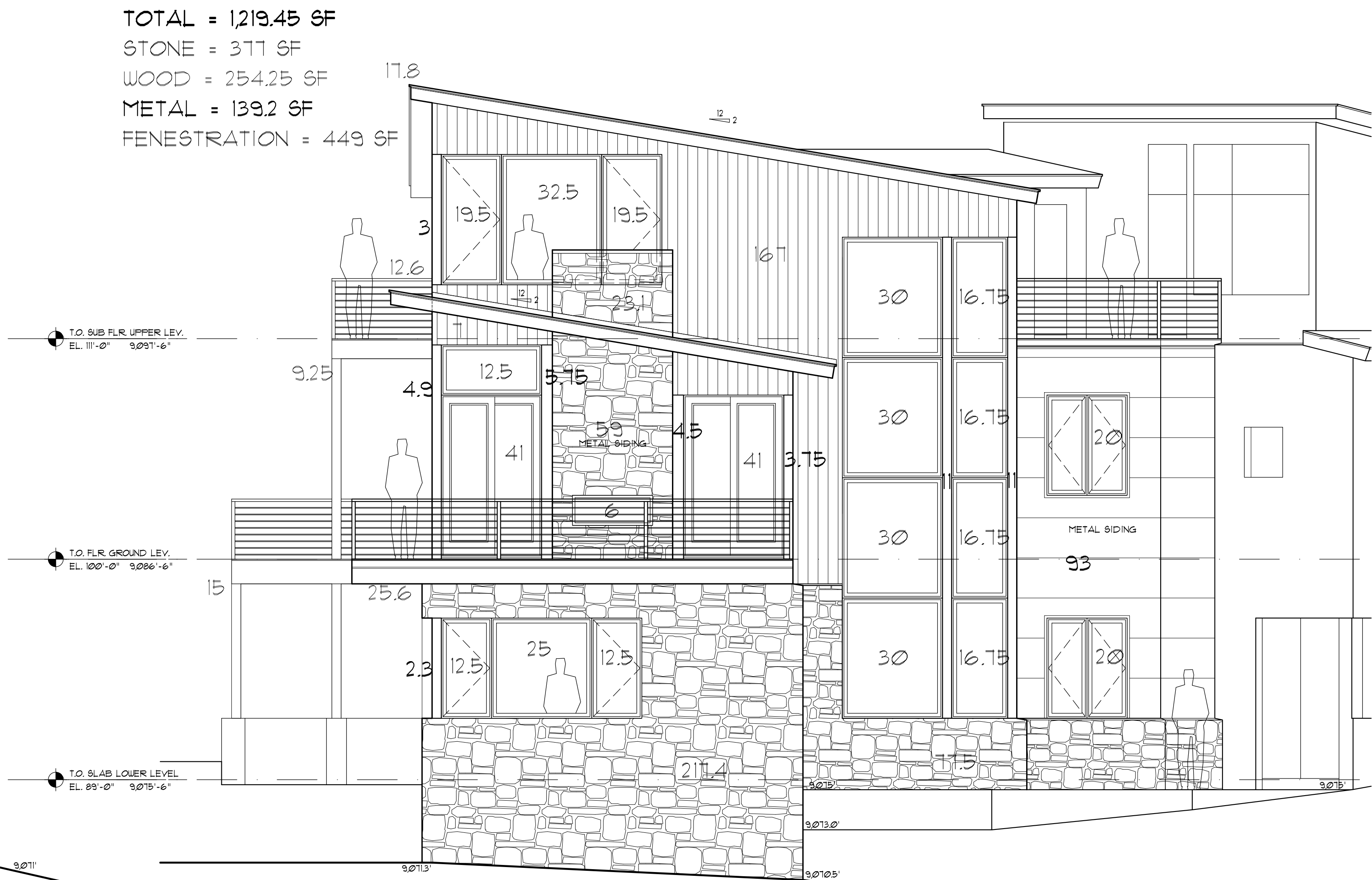

TOTAL = 1,219.45 SF
 STONE = 377 SF
 WOOD = 254.25 SF
 METAL = 139.2 SF
 FENESTRATION = 449 SF

E NORTHWEST ELEVATION - AVE. HT.
 SCALE 1/4" = 1'-0"

COPYRIGHT 2021



REVISIONS:

AR-52 RESIDENCE

PROJECT: #2014

DATE: MAY 24, 2021
 ISSUED FOR: REVIEW SET

SHEET NUMBER: A4-5
 EXT. ELEVS - MATL/CALS

LOCATION: AR-52 123 ADAMS WAY MOUNTAIN VILLAGE SAN MIGUEL COUNTY

FUSE architecture + interior

220 East Colorado Ave., Suite 218 P.O.Box 3934 Telluride CO 81435. Office: 970-728-0841

TOTAL = 901.95 SF
 STONE = 253 SF
 WOOD = 428.2 SF
 METAL = 14.75 SF
 FENESTRATION = 206 SF

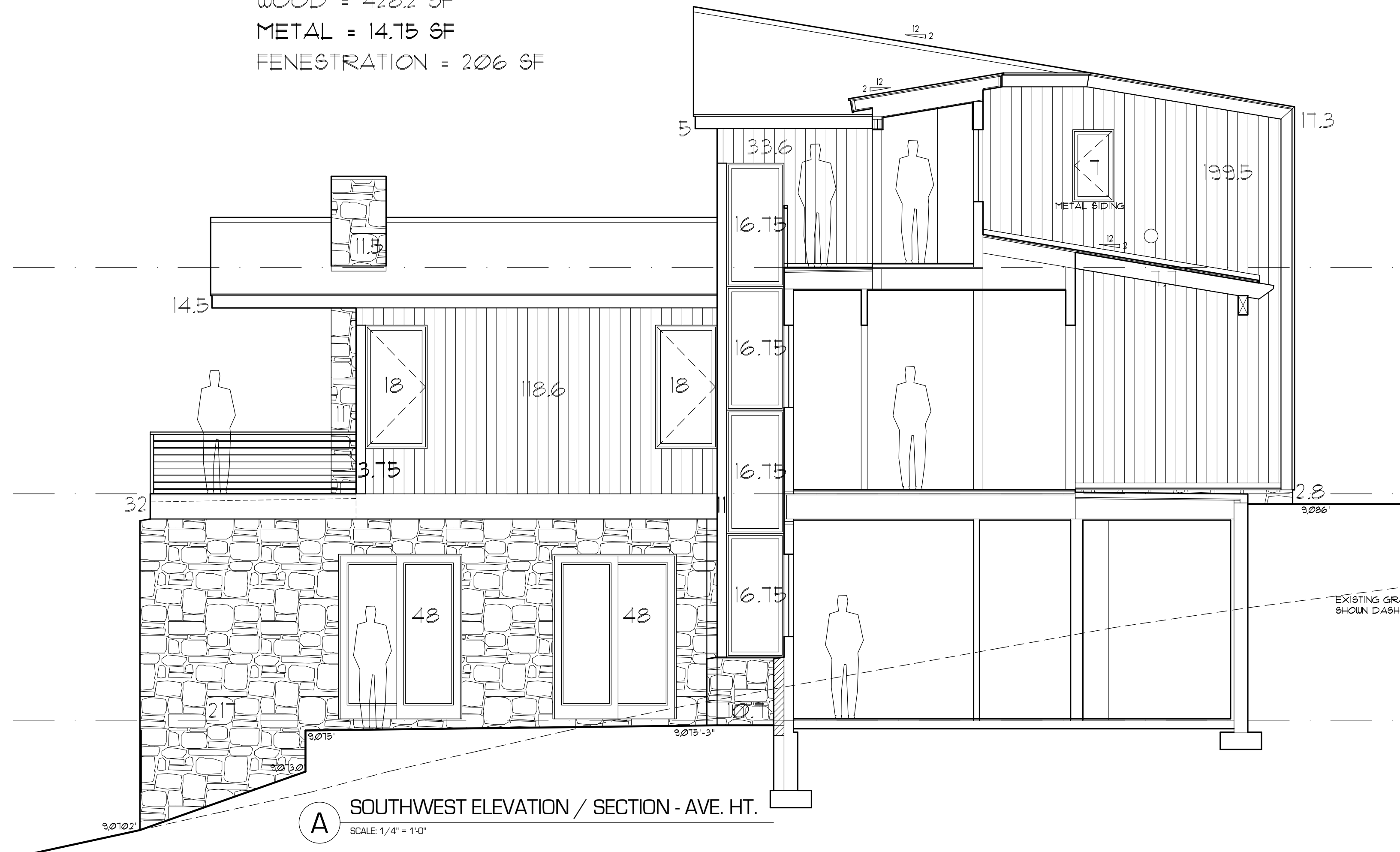

A SOUTHWEST ELEVATION / SECTION - AVE. HT.
 SCALE 1/4" = 1'-0"

OVERALL TOTAL = 6,466 SF	
STONE = 2,263.45 SF	35.0%
WOOD = 1,860.45 SF	28.8%
METAL = 763.15 SF	11.8%
FENESTRATION = 1,578.95 SF	24.4%

GARAGE NORTH TOTAL = 394.0 SF	
STONE = 153.5 SF	
WOOD = 102.75 SF	
METAL = 11.0 SF	
FENESTRATION = 126.75 SF	

GARAGE WEST TOTAL = 843.45 SF	
STONE = 496 SF	
WOOD = 184.75 SF	
METAL = 85.5 SF	
FENESTRATION = 171.2 SF	

GARAGE SOUTH TOTAL = 556.65 SF	
STONE = 402.7 SF	
WOOD = 149.95 SF	
METAL = 0.0 SF	
FENESTRATION = 4.0 SF	

GARAGE EAST TOTAL = 513.25 SF	
STONE = 195.1 SF	
WOOD = 167.75 SF	
METAL = 13.45 SF	
FENESTRATION = 16.5 SF	

HOUSE SE ELEV TOTAL = 574.1 SF	
STONE = 50.3 SF	
WOOD = 118.8 SF	
METAL = 31.9 SF	
FENESTRATION = 86 SF	

HOUSE NE ELEV TOTAL = 1,462.55 SF	
STONE = 335.25 SF	
WOOD = 454 SF	
METAL = 59.2 SF	
FENESTRATION = 613.5 SF	

HOUSE NW ELEV TOTAL = 1,219.45 SF	
STONE = 371 SF	
WOOD = 254.25 SF	
METAL = 139.2 SF	
FENESTRATION = 449 SF	

HOUSE SW ELEV TOTAL = 901.95 SF	
STONE = 253 SF	
WOOD = 428.2 SF	
METAL = 14.75 SF	
FENESTRATION = 206 SF	

COPYRIGHT 2021

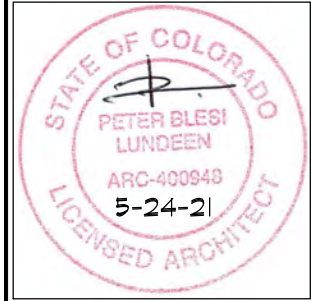

REVISIONS:

AR-52 RESIDENCE

PROJECT: #2014

DATE ISSUED FOR: MAY 24, 2021 REVIEW SET

SHEET NUMBER: A4-6 EXT. ELEV. - MATL. CALCS

LOCATION: AR-52 123 ADAMS WAY MOUNTAIN VILLAGE SAN MIGUEL COUNTY

TOTAL = 394.0 SF
 STONE = 153.5 SF
 WOOD = 102.75 SF
 METAL = 11.0 SF
 FENESTRATION = 126.75 SF

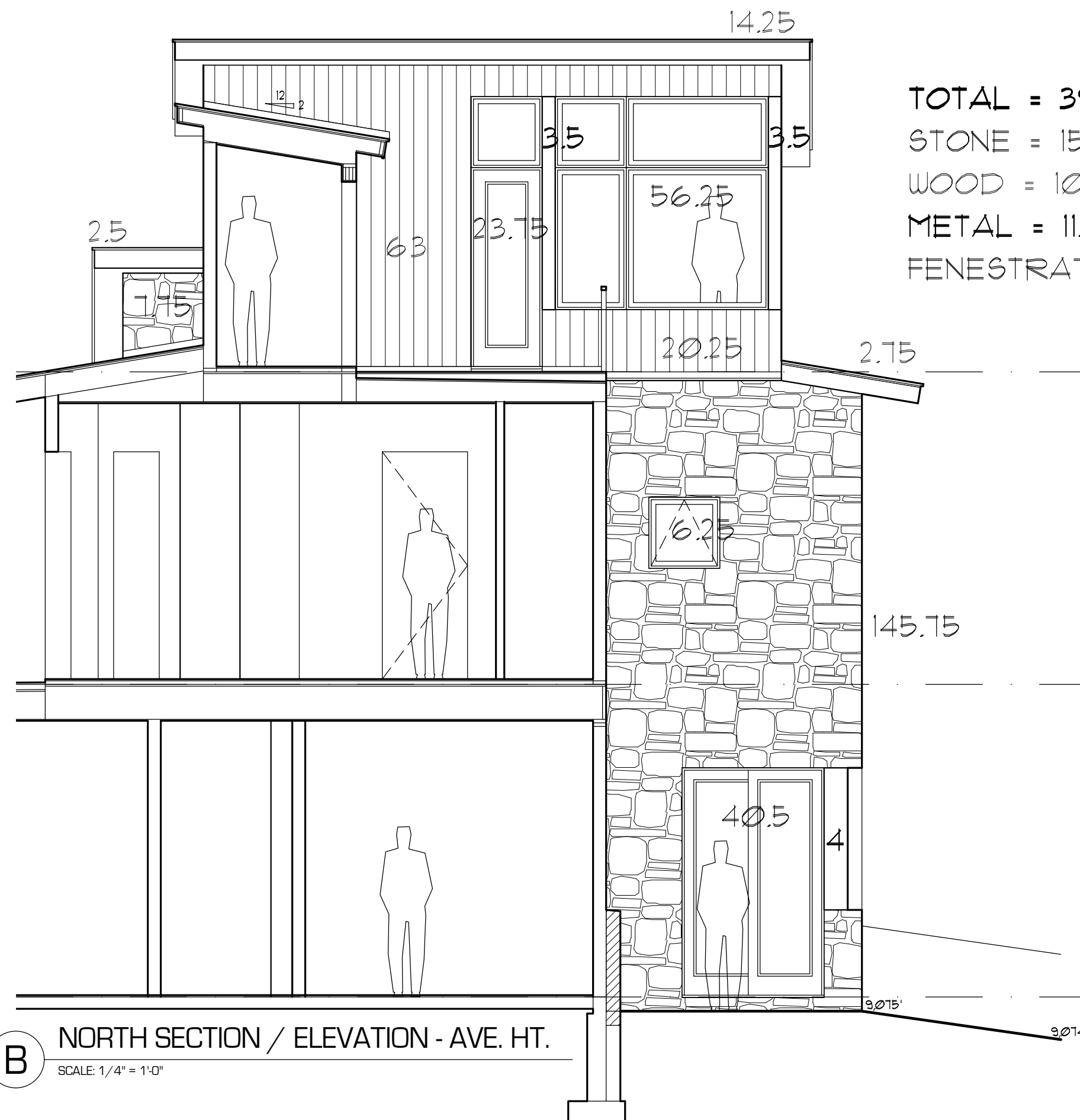

B NORTH SECTION / ELEVATION - AVE. HT.
 SCALE 1/4" = 1'-0"

TOTAL = 843.45 SF
 STONE = 496 SF
 WOOD = 184.75 SF
 METAL = 85.5 SF
 FENESTRATION = 171.2 SF

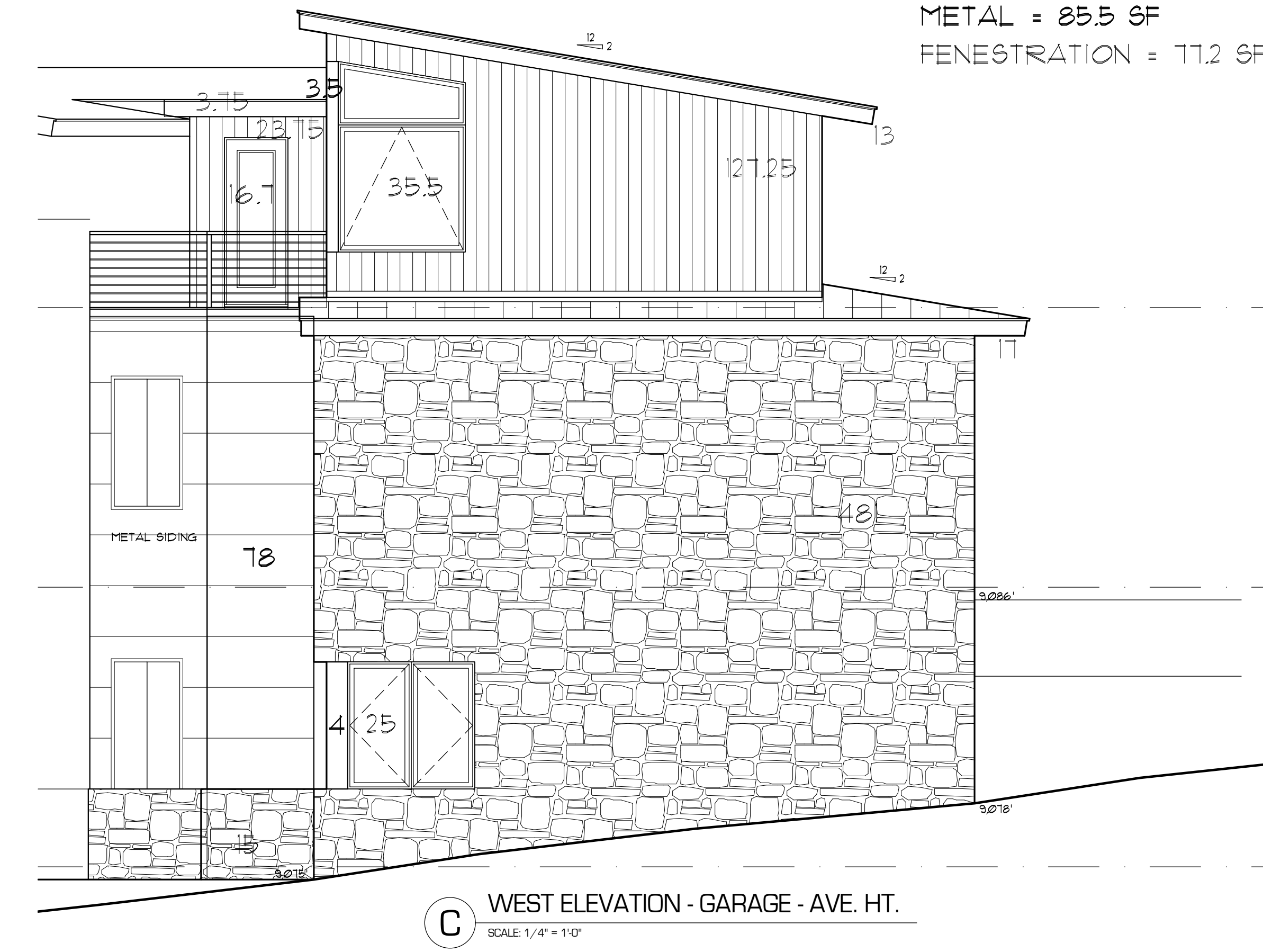

C WEST ELEVATION - GARAGE - AVE. HT.
 SCALE 1/4" = 1'-0"

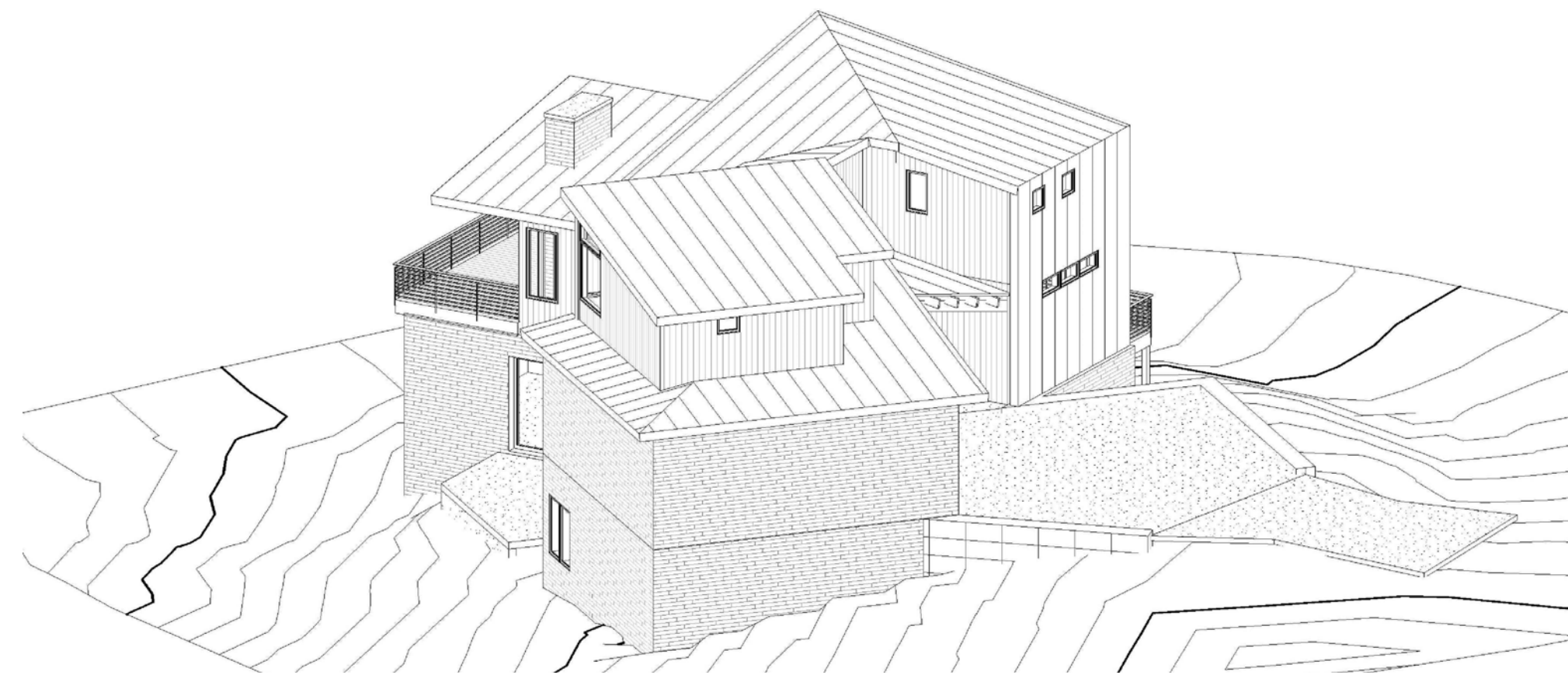

A SOUTHWEST SIDE FROM ABOVE
SCALE: N.T.S.



B SOUTH SIDE FROM ABOVE
SCALE: N.T.S.

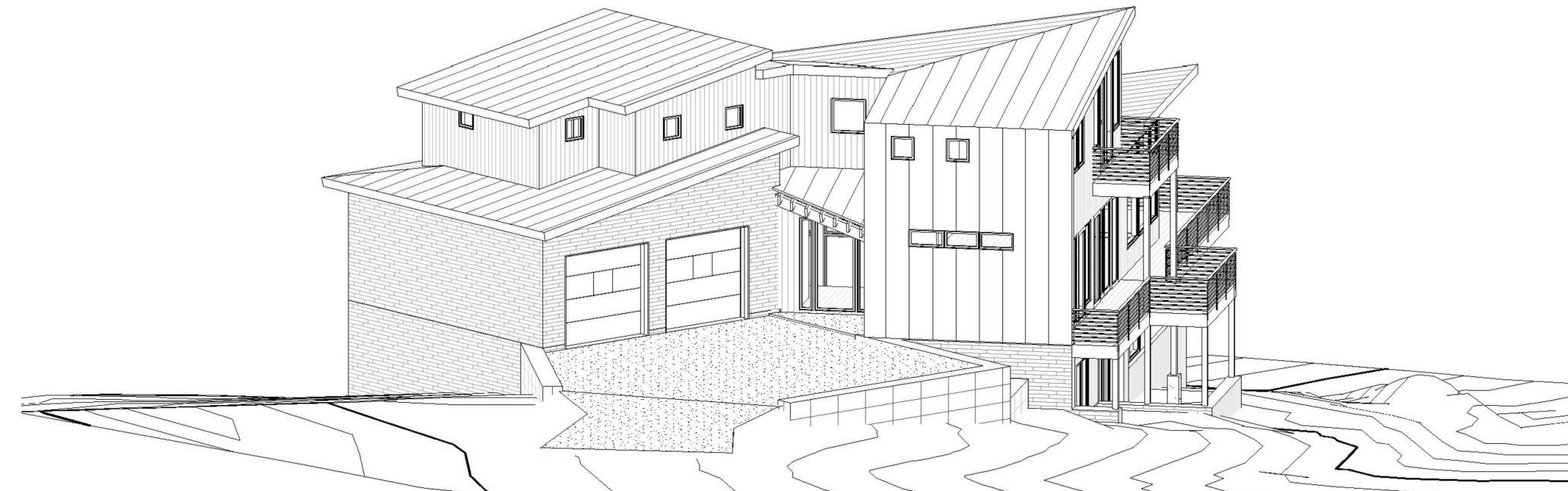

C SOUTHEAST SIDE FROM ABOVE
SCALE: N.T.S.



D SOUTHEAST SIDE FROM ABOVE
SCALE: N.T.S.

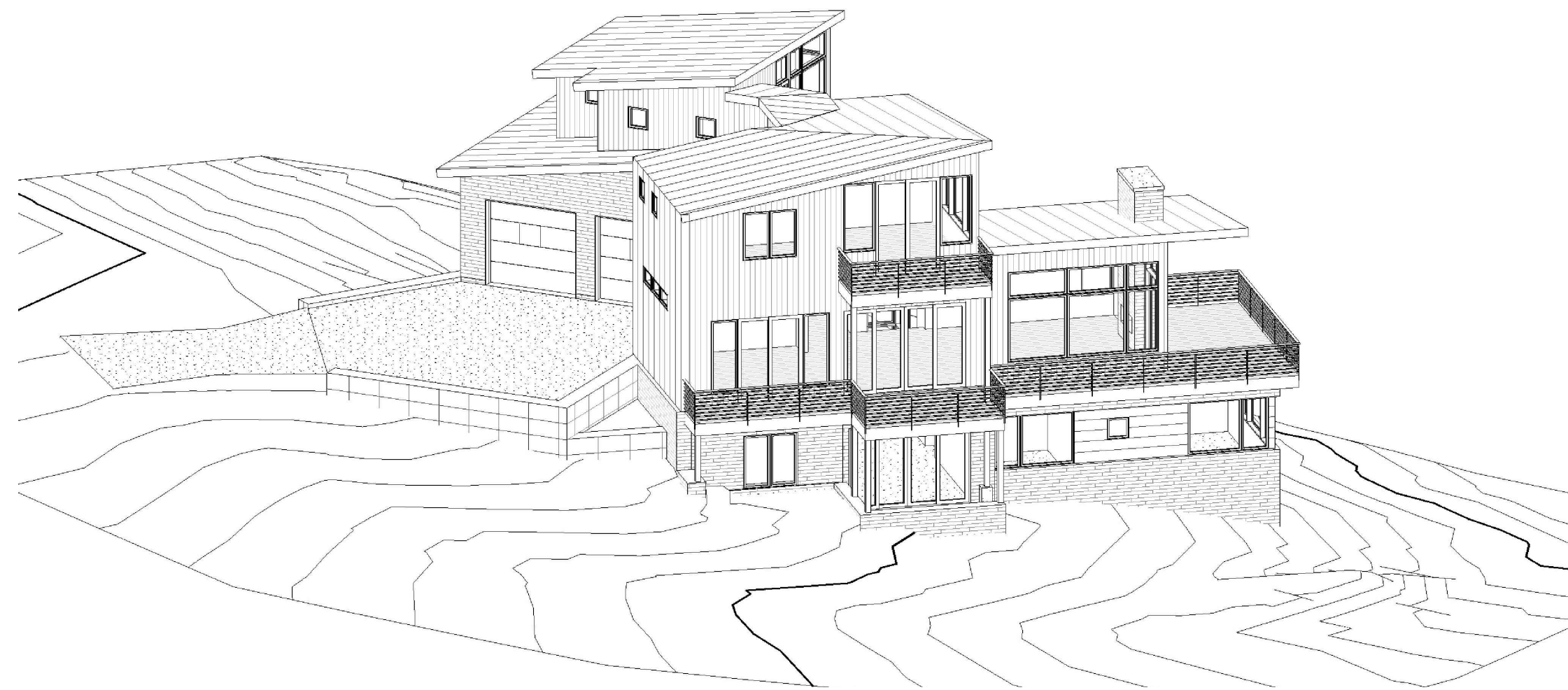

E EAST SIDE FROM ABOVE
SCALE: N.T.S.



F NORTH SIDE FROM ABOVE
SCALE: N.T.S.



G NORTHWEST SIDE FROM ABOVE
SCALE: N.T.S.

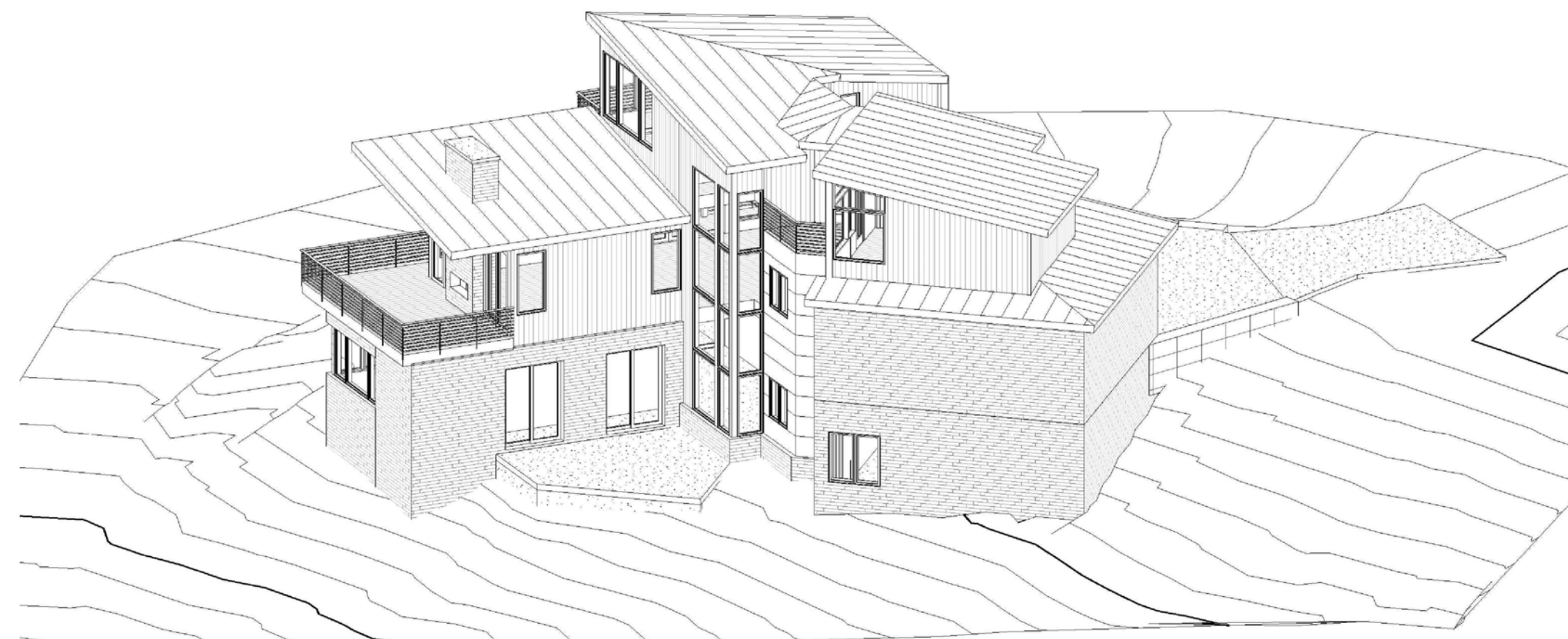

H WEST SIDE FROM ABOVE
SCALE: N.T.S.

NOTE:
3-D IMAGES ARE FOR GENERAL
REFERENCE ONLY - REFER
TO ELEVATIONS AND SECTIONS
FOR MOST CURRENT INFO.

FOR REVIEW ONLY NOT FOR CONSTRUCTION

DATE:
ISSUED FOR:
MAY 24, 2021
REVIEW SET

PROJECT:
#2014

SHEET NUMBER:
A4-7
3D VIEWS

LOCATION:
AR-52 123 ADAMS WAY MOUNTAIN VILLAGE SAN MIGUEL COUNTY

PROJECT:
AR-52 RESIDENCE

REVISIONS:

COPYRIGHT 2021

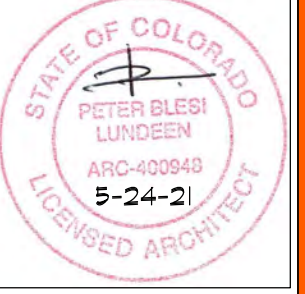



A SOUTH DRIVE VIEW
SCALE: N.T.S.



B SOUTH STREET VIEW
SCALE: N.T.S.



C SOUTHEAST STREET VIEW
SCALE: N.T.S.



D SOUTHEAST STREET VIEW
SCALE: N.T.S.



E EAST STREET VIEW
SCALE: N.T.S.



F NORTHEAST STREET VIEW
SCALE: N.T.S.



G NORTH STREET VIEW
SCALE: N.T.S.



H NORTHWEST VIEW
SCALE: N.T.S.



I WEST VIEW
SCALE: N.T.S.

NOTE:
3-D IMAGES ARE FOR GENERAL
REFERENCE ONLY - REFER
TO ELEVATIONS AND SECTIONS
FOR MOST CURRENT INFO.

FOR REVIEW ONLY NOT FOR CONSTRUCTION

DATE: MAY 24, 2021
ISSUED FOR: REVIEW SET

PROJECT: #2014

REVISIONS:

SHEET NUMBER: A4-8
3D VIEWS

AR-52 RESIDENCE

LOCATION: AR-52 123 ADAMS WAY MOUNTAIN VILLAGE SAN MIGUEL COUNTY

COPYRIGHT 2021

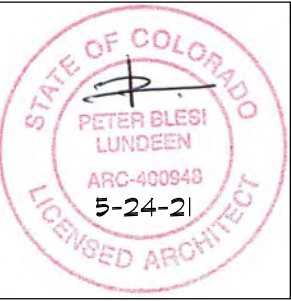



David Craig | CLC | IALD
 209 Hillside Lane
 Telluride, CO 81435
 970.729.1403

AR-52 RESIDENCE

ADAMS WAY
MOUNTAIN VILLAGE

2021.03.16 DRB SUBMITTAL
 2021.03.24 OAC NOTES

LX0 - SITE EXTERIOR LIGHTING PLAN
 LX1 - LOWER LEVEL EXTERIOR LIGHTING PLAN
 LX2 - MAIN LEVEL EXTERIOR LIGHTING PLAN
 LX3 - UPPER LEVEL EXTERIOR LIGHTING PLAN
 LX4 - EXTERIOR LIGHTING ELEVATIONS

SITE EXTERIOR LIGHTING PLAN

LX0

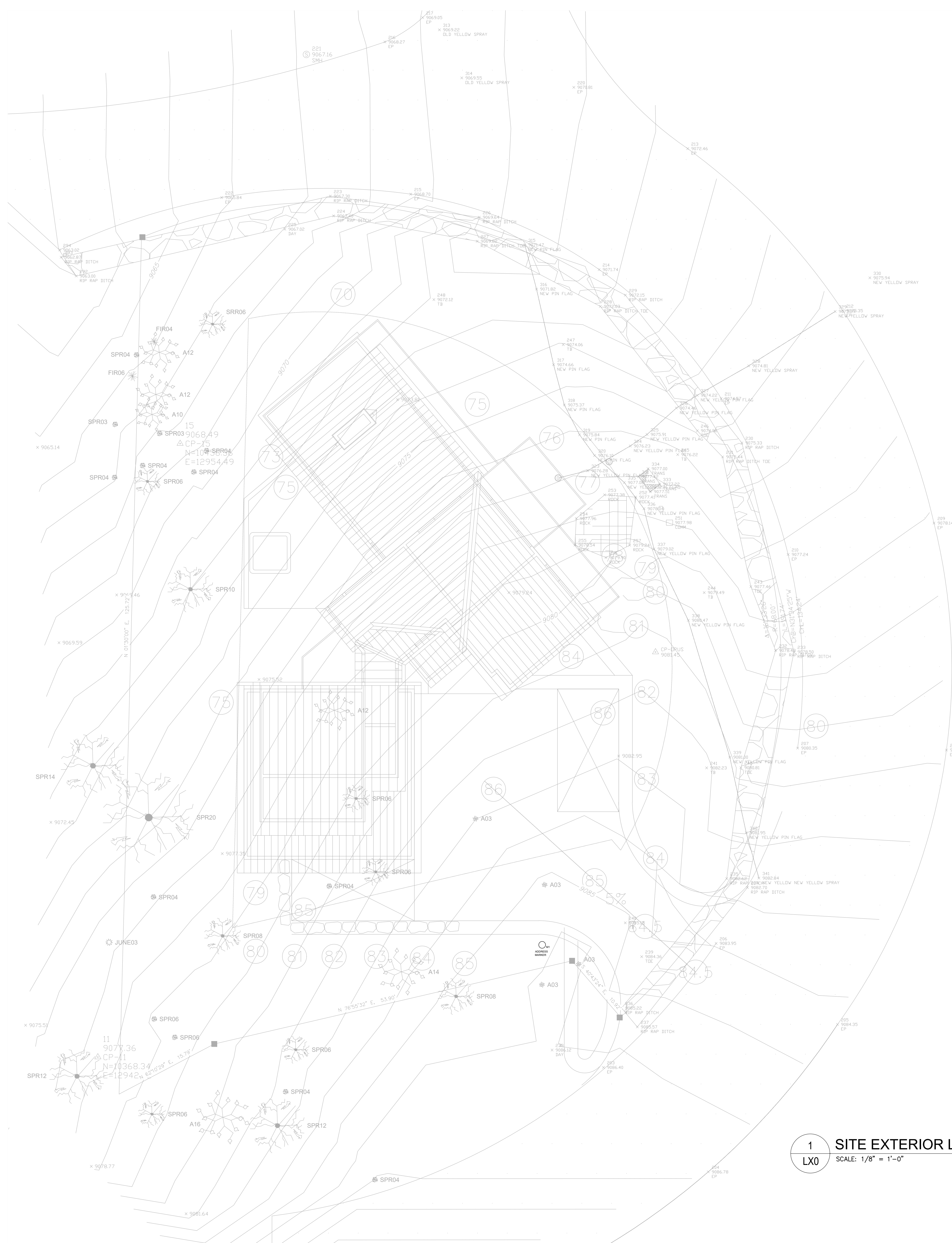

1 SITE EXTERIOR LIGHTING PLAN
 SCALE: 1/8" = 1'-0"

- RECESSED CAN, VERIFY TRIM COLOR
- RECESSED CAN W/ LOW PROFILE HOUSING
- RECESSED CAN, 9:12 TO 12:12 SLOPE
- WALL GRAZE RECESSED CAN 6" OFF STONE
- RECESSED CAN, VERIFY TRIM COLOR
- BG SHOWER BENCH, WET RATED
- BK/BKH EXTERIOR STEP LIGHT
- BL UPLIGHT SCIENCE
- BW BOOT WARMERS
- BQO BBQ LIGHT
- AC AIR CONDITIONING
- CLOCK RECEPTACLE
- RECESSED CAN
- RECESSED CAN WITH ELECTRONIC TRANSFORMER
- CAS ART LIGHTING POWERED BY CLOCK OUTLET
- CLD1 AND CLD2 CLOSET STORAGE
- CSL SURFACE MOUNTED UNDER CABINET
- D RECESSED NON IC CAN
- DP DRAPERY
- D2 RECESSED CAN DOUBLE
- D3 RECESSED CAN TRIPLE
- DX COLUMN UPLIGHT
- RECESSED CAN, SQUARE TRIMLESS
- RECESSED CAN, DUAL LAMP TRIMLESS
- EC VERGE CORNER
- ES STAR HANDRAIL LED
- EW VERTICAL ARCHITECTURAL LED
- LED PANEL
- EW1 ARCHITECTURAL LED
- EXT2 EXTERIOR SCIENCE DARK SKY RATED
- EXT3 EXTERIOR PENDANT
- EXT4 HISTORIC EXTERIOR SCIENCE
- F1-2 2' CLOSET FIXTURE
- F1-4 4' CLOSET FIXTURE
- FL FLOOR RECEPTACLE
- LED / FLUORESCENT SURFACE MOUNT
- FAN CEILING FAN
- FK CEILING FAN LIGHT KIT
- FN EXHAUST FAN
- Fp FIREPLACE CONTROL
- FS FESTOON SUSPENDED BY CABLE
- GFI GROUND FAULT OUTLET
- GAS EXTERIOR GAS SCIENCE
- H RECESSED PUCK LIGHT
- H1 ADJUSTABLE PUCK LIGHT
- HT MIN RECESSED
- HT4 1500W ELECTRIC HEAT
- HX UNDER WATER
- IDF SEMI FLUSH DECORATIVE FIXTURE
- IDP HANGING FIXTURE
- IDS WALL MOUNTED DECORATIVE FIXTURE
- KA CABLE LIGHTING
- LK LANDSCAPE PATH
- EX# LANDSCAPE LOAD NUMBER
- # LOAD NUMBER
- S MOTORIZED SHADE
- SB MOTORIZED BLACK OUT SHADE
- DP MOTORIZED DRAPERY
- MM SINGLE HEAD MONOPOINT
- MM MAKEUP MIRROR
- MM2 DOUBLE HEADED MONOPOINT
- MS MOTION SENSOR
- ML MIRROR W/ INTEGRATED LIGHTING
- MTV TELEVISION
- MZ MEZZALUNA WALL
- P PENDANT
- PD LED STRIP W/ STRAIGHT CHANNEL
- PD VERTICAL LED STRIP
- PD1 WET RATED VERTICAL LED
- PD1 WET RATED LED STRIP
- PD45 LED IN 45 DEGREE CHANNEL
- PD FLOATING MIRROR
- PBR MINI LINEAR LED
- IPRT RECESS TROUGH
- ENC LIGHTING MODULE ENCLOSURE
- PROJ PROJECTOR (BY OTHERS)
- PX POOL LIGHT
- RUS SUSPENDED MAGNET
- RW RECESS MAGNET
- J STW THIN WALL OUTLET / USB
- RU STEP LIGHT
- SA READING LIGHT
- SS SUSPENSORS
- rv1 THIN WALL VERTICAL
- SW JAMB SWITCH
- S SINGLE POLE SWITCH
- S3 THREE WAY SWITCH
- S33 THREE WAY WALL BOX DIMMER
- S4 SINGLE POLE WALL BOX DIMMER
- Sf EXHAUST FAN SWITCH WITH TIME OUT
- Sm INTEGRATED WALL BOX SMART DIMMER SWITCHED OUTLET
- TRANSFORMER/DRIWER, WATTAGE TBD
- TWV WALL MOUNTED MONORAIL
- TWH THIN WALL HORIZONTAL
- TC TIME CLOCK
- TL TABLE LAMP
- TS MONORAIL SYSTEMS
- IN GROUND UPLIGHT
- VA VANITY SCIENCE
- VAPOR PROOF FIXTURE
- VP1 VAPOR PROOF WALL MOUNT
- WW RECESS WALL WASHER
- X WALL SCIENCE W/ INTEGRAL SWITCH
- Z SURFACE MOUNTED CEILING W/ LENS

PROJECT

ADDRESS

SUBMITTAL

SHEET INDEX

DWG TITLE

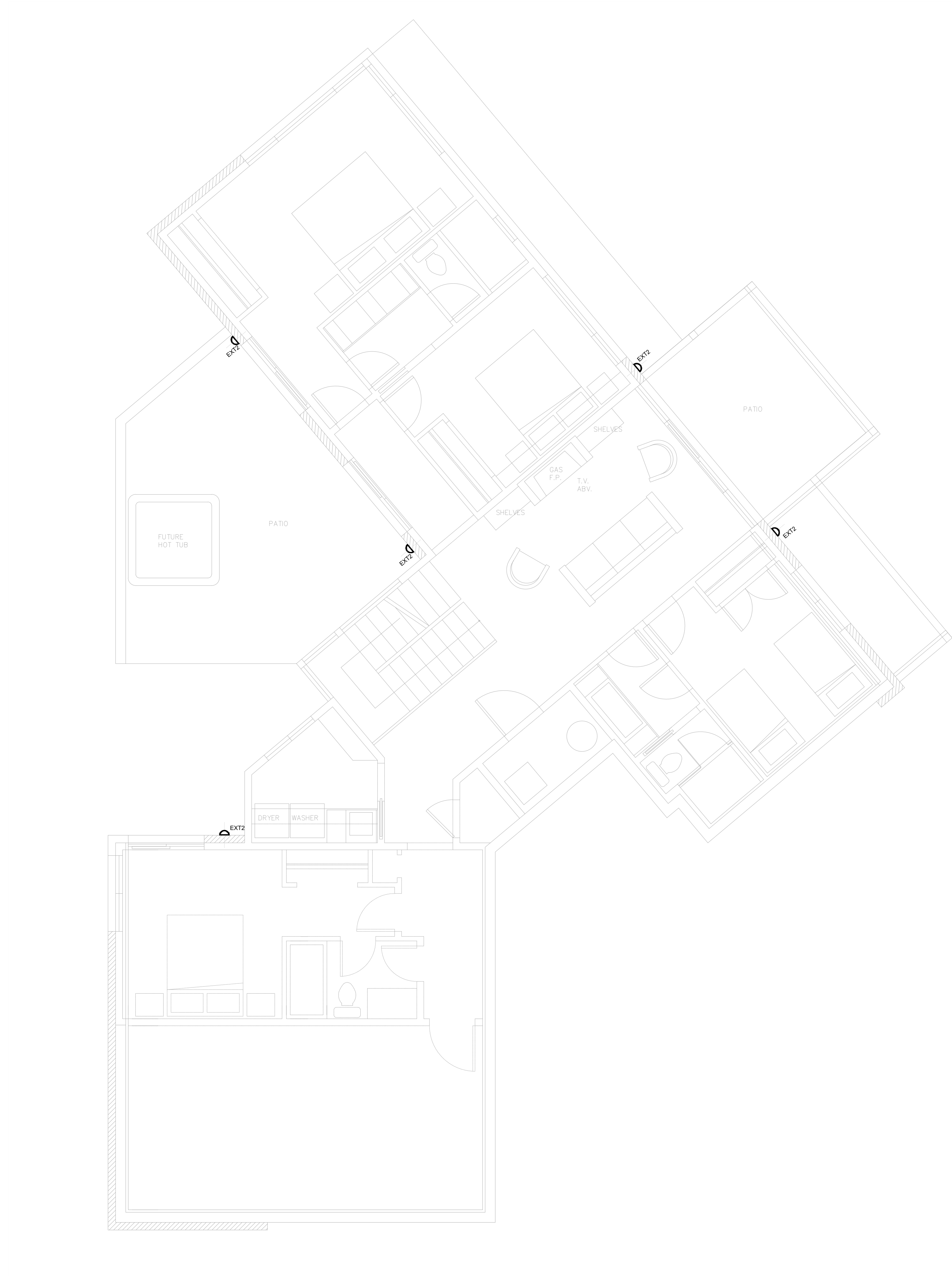

1 LOWER LEVEL EXTERIOR LIGHTING PLAN
 LX1 SCALE: 1/4" = 1'-0"

- RECESSED CAN, VERIFY TRIM COLOR
- RECESSED CAN W/ LOW PROFILE HOUSING
- RECESSED CAN, 9:12 TO 12:12 SLOPE
- WALL GRAZE RECESSED CAN 6" OFF STONE
- RECESSED CAN, VERIFY TRIM COLOR
- SHOWER BENCH, WET RATED
- BKVBKH EXTERIOR STEP LIGHT
- BL UPLIGHT SCIENCE
- BW BOOT WARMERS
- BBQ BBQ LIGHT
- AC AIR CONDITIONING
- CLOCK RECEPTACLE
- RECESSED CAN
- RECESSED CAN WITH ELECTRONIC TRANSFORMER
- CAS ART LIGHTING POWERED BY CLOCK OUTLET
- CLD1 AND CLD2 CLOSET STORAGE
- CSL SURFACE MOUNTED UNDER CABINET
- D RECESSED NON IC CAN
- DP DRAPERY
- D2 RECESSED CAN DOUBLE
- D3 RECESSED CAN TRIPLE
- DX COLUMN UPLIGHT
- RECESSED CAN, SQUARE TRIMLESS
- RECESSED CAN, DUAL LAMP TRIMLESS
- EC VERGE CORNER
- ES STAIR HANDRAIL LED
- EW VERTICAL ARCHITECTURAL LED
- EW1 LED PANEL
- EW2 ARCHITECTURAL LED
- EXT2 EXTERIOR SCIENCE DARK SKY RATED
- EXT3 EXTERIOR PENDANT
- EXT4 HISTORIC EXTERIOR SCIENCE
- F1-2 2' CLOSET FIXTURE
- F1-4 4' CLOSET FIXTURE
- F1-6 FLOOR RECEPTACLE
- F1-8 LED / FLUORESCENT SURFACE MOUNT
- FAN CEILING FAN
- FK CEILING FAN LIGHT KIT
- FN EXHAUST FAN
- Fp FIREPLACE CONTROL
- FS FESTOON SUSPENDED BY CABLE
- GAS GROUND FAULT OUTLET
- GAS EXTERIOR GAS SCIENCE
- H RECESSED PUCK LIGHT
- H1 ADJUSTABLE PUCK LIGHT
- HT4 1500W ELECTRIC HEAT
- HX UNDER WATER
- IDF SEMI FLUSH DECORATIVE FIXTURE
- IDP HANGING FIXTURE
- IDS WALL MOUNTED DECORATIVE FIXTURE
- KA CABLE LIGHTING
- KA LIGHTING / SHADING KEYPAD
- LX LANDSCAPE PATH
- EX# LANDSCAPE LOAD NUMBER
- # LOAD NUMBER
- S MOTORIZED SHADE
- SB MOTORIZED BLACK OUT SHADE
- DP MOTORIZED DRAPERY
- M SINGLE HEAD MONOPOINT
- MM MAKEUP MIRROR
- MO2 DOUBLE HEADED MONOPOINT
- MS MOTION SENSOR
- ML MIRROR W/ INTEGRATED LIGHTING
- MTV TELEVISION
- MZ MEZZALUNA WALL
- P PENDANT
- PD LED STRIP W/ STRAIGHT CHANNEL
- PD VERTICAL LED STRIP
- PD1 WET RATED VERTICAL LED
- PD1 WET RATED LED STRIP
- PD45 LED IN 45 DEGREE CHANNEL
- PD FLOATING MIRROR
- FLR MINI LINEAR LED
- IGRT RECESS TROUGH
- TLN LIGHTING MODULE ENCLOSURE
- PROJ PROJECTOR (BY OTHERS)
- PX POOL LIGHT
- RMS SUSPENDED MAGNET
- RW RECESS MAGNET
- J STW THIN WALL OUTLET / USB
- S STEP LIGHT
- SA READING LIGHT
- SS SUSPENDERS
- r1 THIN WALL VERTICAL
- JAMB SWITCH
- S SINGLE POLE SWITCH
- S3 THREE WAY SWITCH
- S3d THREE WAY WALL BOX DIMMER
- S4 SINGLE POLE WALL BOX DIMMER
- Sf EXHAUST FAN SWITCH WITH TIME OUT
- S5 INTEGRATED WALL BOX SMART DIMMER SWITCHED OUTLET
- TRANSFORMERDRIVER, WATTAGE TBD
- TWW WALL MOUNTED MONORAIL
- TW THIN WALL HORIZONTAL
- Tc TIME CLOCK
- TL TABLE LAMP
- TW MONORAIL SYSTEMS
- IN GROUND UPLIGHT
- VA VANITY SCIENCE
- VAPOR PROOF FIXTURE
- VP1 VAPOR PROOF WALL MOUNT
- WW RECESS WALL WASHER
- X WALL SCIENCE W/ INTEGRAL SWITCH
- Z SURFACE MOUNTED CEILING W/ LENS



David Craig | CLC | IALD
 209 Hillside Lane
 Telluride, CO 81435
 970.729.1403

AR-52 RESIDENCE

ADAMS WAY MOUNTAIN VILLAGE

2021.03.16 DRB SUBMITTAL
 2021.03.24 OAC NOTES

- LX0 - SITE EXTERIOR LIGHTING PLAN
- LX1 - LOWER LEVEL EXTERIOR LIGHTING PLAN
- LX2 - MAIN LEVEL EXTERIOR LIGHTING PLAN
- LX3 - UPPER LEVEL EXTERIOR LIGHTING PLAN
- LX4 - EXTERIOR LIGHTING ELEVATIONS

LOWER LEVEL EXTERIOR LIGHTING PLAN

LX1

PROJECT

ADDRESS

SUBMITTAL

SHEET INDEX

DWG TITLE

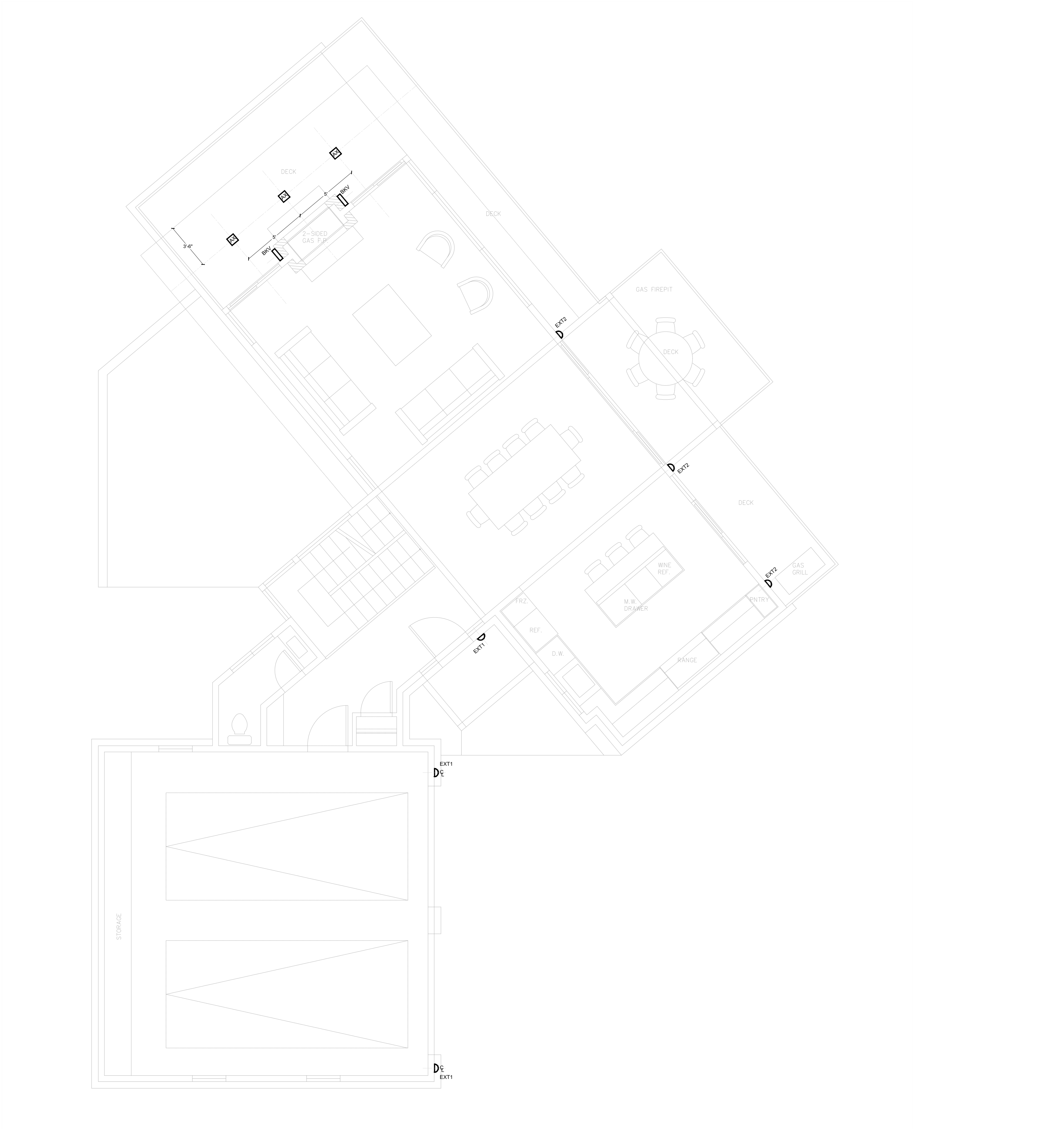

2 MAIN LEVEL EXTERIOR LIGHTING PLAN
 LX2 SCALE: 1/4" = 1'-0"

- RECESSED CAN, VERIFY TRIM COLOR
- RECESSED CAN W/ LOW PROFILE HOUSING
- RECESSED CAN, 9:12 TO 12:12 SLOPE
- WALL GRAZE RECESSED CAN 6" OFF STONE
- RECESSED CAN, VERIFY TRIM COLOR
- BG SHOWER BENCH, WET RATED
- BKVBKH EXTERIOR STEP LIGHT
- BL UPLIGHT SCIENCE
- BW BOOT WARMERS
- BBQ BBQ LIGHT
- AC AIR CONDITIONING
- CLOCK RECEPTACLE
- RECESSED CAN
- RECESSED CAN WITH ELECTRONIC TRANSFORMER
- CAS ART LIGHTING POWERED BY CLOCK OUTLET
- CLD1 AND CLD2 CLOSET STORAGE
- CSL SURFACE MOUNTED UNDER CABINET
- D RECESSED NON IC CAN
- DP DRAPERY
- D2 RECESSED CAN DOUBLE
- D3 RECESSED CAN TRIPLE
- DX COLUMN UPLIGHT
- RECESSED CAN, SQUARE TRIMLESS
- RECESSED CAN, DUAL LAMP TRIMLESS
- EC VERGE CORNER
- ES STAR HANDRAIL LED
- EW VERTICAL ARCHITECTURAL LED
- EW1 LED PANEL
- EW2 ARCHITECTURAL LED
- EXT2 EXTERIOR SCIENCE DARK SKY RATED
- EXT3 EXTERIOR PENDANT
- EXT4 HISTORIC EXTERIOR SCIENCE
- F1-2' 2' CLOSET FIXTURE
- F1-4' 4' CLOSET FIXTURE
- FLOOR RECEPTACLE
- LED / FLUORESCENT SURFACE MOUNT
- FAN CEILING FAN
- FK CEILING FAN LIGHT KIT
- FN EXHAUST FAN
- Fp FIREPLACE CONTROL
- FS FESTOON SUSPENDED BY CABLE
- GAS EXTERIOR GAS SCIENCE
- H RECESSED PUCK LIGHT
- H1 ADJUSTABLE PUCK LIGHT
- HT4 1500W ELECTRIC HEAT
- HX UNDER WATER
- IDF SEMI FLUSH DECORATIVE FIXTURE
- IDP HANGING FIXTURE
- IDS WALL MOUNTED DECORATIVE FIXTURE
- KA CABLE LIGHTING
- LANDSCAPE PATH
- LANDSCAPE LOAD NUMBER
- LOAD NUMBER
- S MOTORIZED SHADE
- SB MOTORIZED BLACK OUT SHADE
- DP MOTORIZED DRAPERY
- MM SINGLE HEAD MONOPOINT
- MM MAKEUP MIRROR
- MM2 DOUBLE HEADED MONOPOINT
- MS MOTION SENSOR
- ML MIRROR W/ INTEGRATED LIGHTING
- MTV TELEVISION
- MZ MEZZALUNA WALL
- P PENDANT
- PD LED STRIP W/ STRAIGHT CHANNEL
- PD VERTICAL LED STRIP
- PD1 WET RATED VERTICAL LED
- PD1 WET RATED LED STRIP
- PD45 LED IN 45 DEGREE CHANNEL
- PD FLOATING MIRROR
- PLR MINI LINEAR LED
- RECESS TROUGH
- RECESS TROUGH
- PROJ PROJECTOR (BY OTHERS)
- PK POOL LIGHT
- RMS SUSPENDED MAGNET
- RW RECESS MAGNET
- J STW THIN WALL OUTLET / USB
- S STEP LIGHT
- SA READING LIGHT
- SS SUSPENDERS
- r1 THIN WALL VERTICAL
- S1 JAMB SWITCH
- S3 SINGLE POLE SWITCH
- S3 THREE WAY SWITCH
- S3d THREE WAY WALL BOX DIMMER
- S4 SINGLE POLE WALL BOX DIMMER
- Sf EXHAUST FAN SWITCH WITH TIME OUT
- S5 INTEGRATED WALL BOX SMART DIMMER SWITCHED OUTLET
- TRANSFORMER/DRIVER, WATTAGE TBD
- TWW WALL MOUNTED MONORAIL
- TW THIN WALL HORIZONTAL
- Tc TIME CLOCK
- TL TABLE LAMP
- TW MONORAIL SYSTEMS
- IN GROUND UPLIGHT
- VA VANITY SCIENCE
- VAPOR PROOF FIXTURE
- VP1 VAPOR PROOF WALL MOUNT
- WV RECESS WALL WASHER
- X WALL SCIENCE W/ INTEGRAL SWITCH
- Z SURFACE MOUNTED CEILING W/ LENS



David Craig | CLC | IALD
 209 Hillside Lane
 Telluride, CO 81435
 970.729.1403

AR-52 RESIDENCE

ADAMS WAY MOUNTAIN VILLAGE

2021.03.16 DRB SUBMITTAL
 2021.03.24 OAC NOTES

- LX0 - SITE EXTERIOR LIGHTING PLAN
- LX1 - LOWER LEVEL EXTERIOR LIGHTING PLAN
- LX2 - MAIN LEVEL EXTERIOR LIGHTING PLAN
- LX3 - UPPER LEVEL EXTERIOR LIGHTING PLAN
- LX4 - EXTERIOR LIGHTING ELEVATIONS

MAIN LEVEL EXTERIOR LIGHTING PLAN

LX2

PROJECT

ADDRESS

SUBMITTAL

SHEET INDEX

DWG TITLE

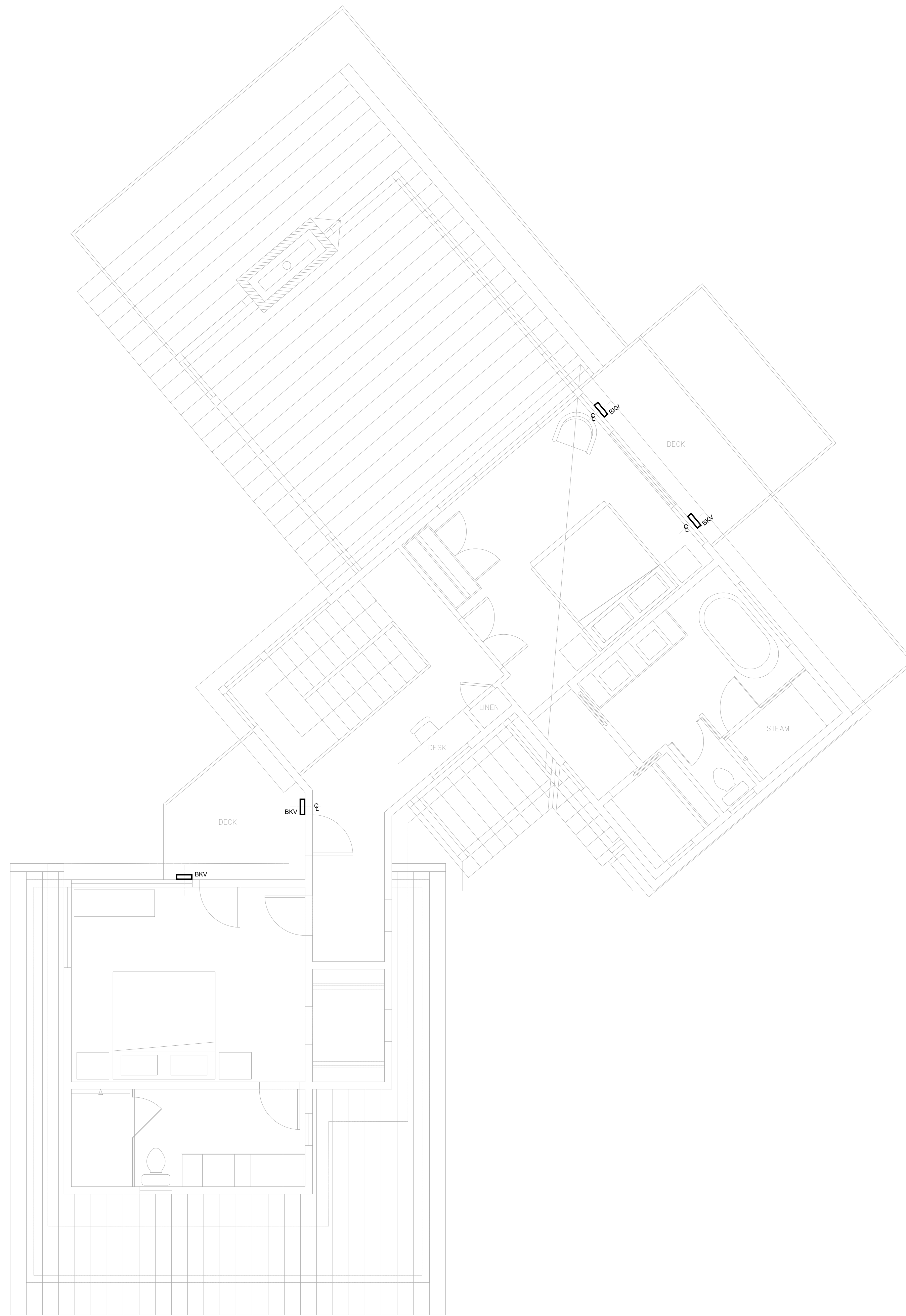

3 UPPER LEVEL EXTERIOR LIGHTING PLAN
 LX3 SCALE: 1/4" = 1'-0"

- RECESSED CAN, VERIFY TRIM COLOR
- RECESSED CAN W/ LOW PROFILE HOUSING
- RECESSED CAN, 9:12 TO 12:12 SLOPE
- WALL GRAZE RECESSED CAN 6" OFF STONE
- RECESSED CAN, VERIFY TRIM COLOR
- BG SHOWER BENCH, WET RATED
- BKVBKH EXTERIOR STEP LIGHT
- BL UPLIGHT SCOSCE
- BW BOOT WARMERS
- BBQ BBQ LIGHT
- AC AIR CONDITIONING
- CLOCK RECEPTACLE
- RECESSED CAN
- RECESSED CAN WITH ELECTRONIC TRANSFORMER
- CAS ART LIGHTING POWERED BY CLOCK OUTLET
- CLD1 AND CLD2 CLOSET STORAGE
- CSL SURFACE MOUNTED UNDER CABINET
- D RECESSED NON IC CAN
- DP DRAPERLY
- D2 RECESSED CAN DOUBLE
- D3 RECESSED CAN TRIPLE
- DX COLUMN UPLIGHT
- RECESSED CAN, SQUARE TRIMLESS
- RECESSED CAN, DUAL LAMP TRIMLESS
- EC VERGE CORNER
- ES STAR HANDRAIL LED
- EW VERTICAL ARCHITECTURAL LED
- EW1 LED PANEL
- EW2 ARCHITECTURAL LED
- EXT2 EXTERIOR SCOSCE DARK SKY RATED
- EXT3 EXTERIOR PENDANT
- EXT4 HISTORIC EXTERIOR SCOSCE
- F1-2' 2' CLOSET FIXTURE
- F1-4' 4' CLOSET FIXTURE
- FL FLOOR RECEPTACLE
- LED / FLUORESCENT SURFACE MOUNT
- FAN CEILING FAN
- FK CEILING FAN LIGHT KIT
- FN EXHAUST FAN
- Fp FIREPLACE CONTROL
- FS FESTOON SUSPENDED BY CABLE
- GFI GROUND FAULT OUTLET
- GAS EXTERIOR GAS SCOSCE
- H RECESSED PUCK LIGHT
- H1 ADJUSTABLE PUCK LIGHT
- HT4 1500W ELECTRIC HEAT
- HX UNDER WATER
- IDF SEMI FLUSH DECORATIVE FIXTURE
- IDP HANGING FIXTURE
- IDS WALL MOUNTED DECORATIVE FIXTURE
- KA CABLE LIGHTING
- LA LIGHTING / SHADING KEYPAD
- LX LANDSCAPE PATH
- EX# LANDSCAPE LOAD NUMBER
- # LOAD NUMBER
- S MOTORIZED SHADE
- SB MOTORIZED BLACK OUT SHADE
- DP MOTORIZED DRAPERLY
- M SINGLE HEAD MONOPOINT
- MM MAKEUP MIRROR
- MO2 DOUBLE HEADED MONOPOINT
- MS MOTION SENSOR
- ML MIRROR W/ INTEGRATED LIGHTING
- MTV TELEVISION
- MZ MEZZALUNA WALL
- P PENDANT
- PD LED STRIP W/ STRAIGHT CHANNEL
- PD VERTICAL LED STRIP
- PD1 WET RATED VERTICAL LED
- PD1 WET RATED LED STRIP
- PD45 LED IN 45 DEGREE CHANNEL
- PD FLOATING MIRROR
- FLR MINI LINEAR LED
- IGRT RECESS TROUGH
- TNL LIGHTING MODULE ENCLOSURE
- PROJ PROJECTOR (BY OTHERS)
- PX POOL LIGHT
- RMS SUSPENDED MAGNET
- RM RECESS MAGNET
- J STW THIN WALL OUTLET / USB
- RU STEP LIGHT
- SA READING LIGHT
- SS SUSPENDERS
- r+1 TWV THIN WALL VERTICAL
- S1 JAMB SWITCH
- S SINGLE POLE SWITCH
- S3 THREE WAY SWITCH
- S3d THREE WAY WALL BOX DIMMER
- S4 SINGLE POLE WALL BOX DIMMER
- Sf EXHAUST FAN SWITCH WITH TIME OUT
- Sfn INTEGRATED WALL BOX SMART DIMMER SWITCHED OUTLET
- TRANSFORMERDRIVER, WATTAGE TBD
- TWW WALL MOUNTED MONORAIL
- TWH THIN WALL HORIZONTAL
- Tc TIME CLOCK
- TL TABLE LAMP
- TW MONORAIL SYSTEMS
- IN GROUND UPLIGHT
- VA VANITY SCOSCE
- VAPOR PROOF FIXTURE
- VP1 VAPOR PROOF WALL MOUNT
- WW RECESS WALL WASHER
- X WALL SCOSCE W/ INTEGRAL SWITCH
- Z SURFACE MOUNTED CEILING W/ LENS



David Craig | CLC | IALD
 209 Hillside Lane
 Telluride, CO 81435
 970.729.1403

AR-52 RESIDENCE

ADAMS WAY MOUNTAIN VILLAGE

2021.03.16 DRB SUBMITTAL
 2021.03.24 OAC NOTES

- LX0 - SITE EXTERIOR LIGHTING PLAN
- LX1 - LOWER LEVEL EXTERIOR LIGHTING PLAN
- LX2 - MAIN LEVEL EXTERIOR LIGHTING PLAN
- LX3 - UPPER LEVEL EXTERIOR LIGHTING PLAN
- LX4 - EXTERIOR LIGHTING ELEVATIONS

UPPER LEVEL EXTERIOR LIGHTING PLAN

LX3

PROJECT

ADDRESS

SUBMITTAL

SHEET INDEX

DWG TITLE

- RECESS
- BKV STEP LIGHT
- EXT2 WALL SCOSCE
- EXT1 WALL SCOSCE



David Craige | CLC | IALD
 209 Hillside Lane
 Telluride, CO 81435
 970.729.1403

AR-52 RESIDENCE

ADAMS WAY
MOUNTAIN VILLAGE

2021.03.16 DRB SUBMITTAL
 2021.03.24 OAC NOTES

- LX0 - SITE EXTERIOR LIGHTING PLAN
- LX1 - LOWER LEVEL EXTERIOR LIGHTING PLAN
- LX2 - MAIN LEVEL EXTERIOR LIGHTING PLAN
- LX3 - UPPER LEVEL EXTERIOR LIGHTING PLAN
- LX4 - EXTERIOR LIGHTING ELEVATIONS

EXTERIOR LIGHTING ELEVATIONS

LX4

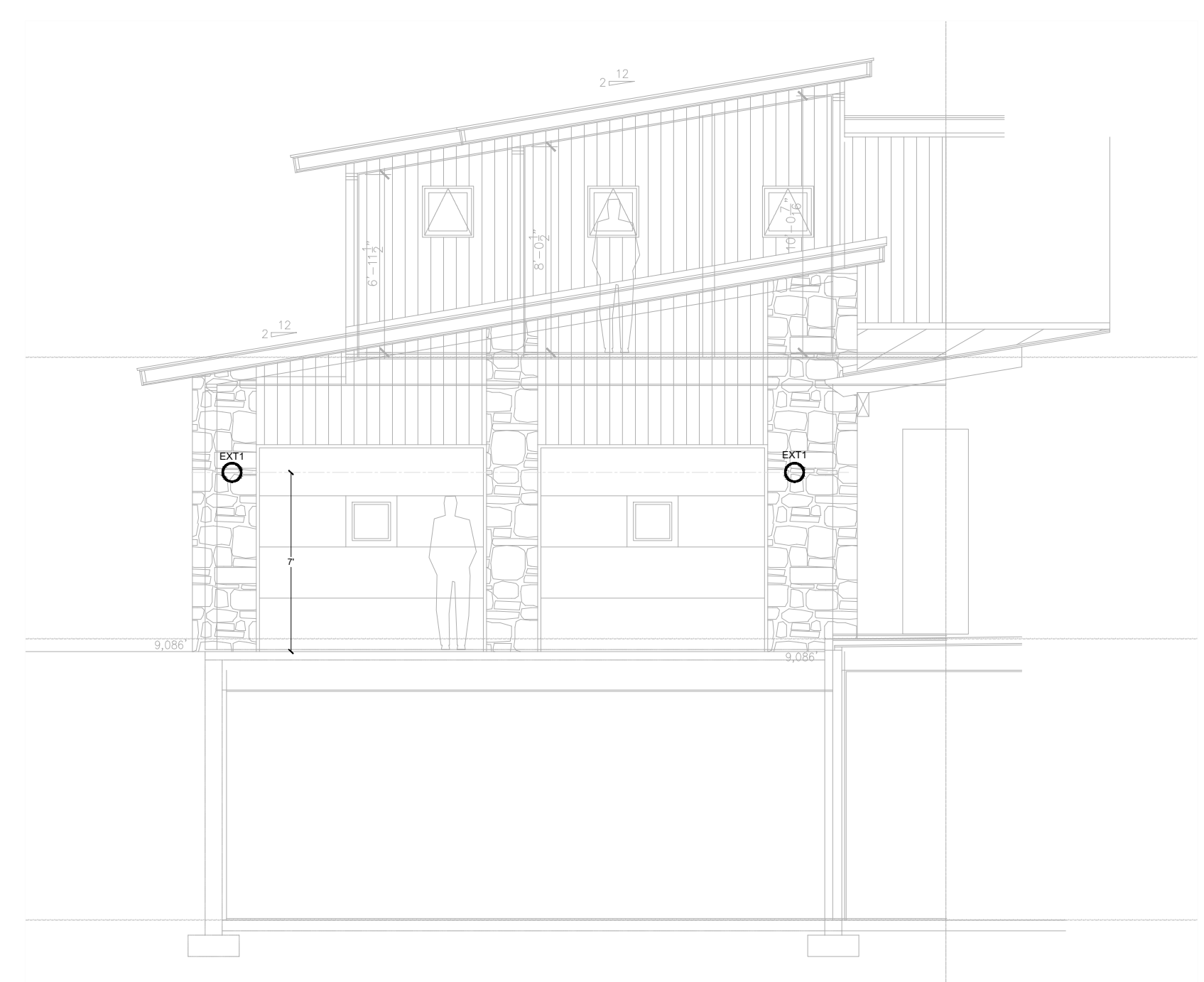

EAST ELEV AS OF 3-25-21

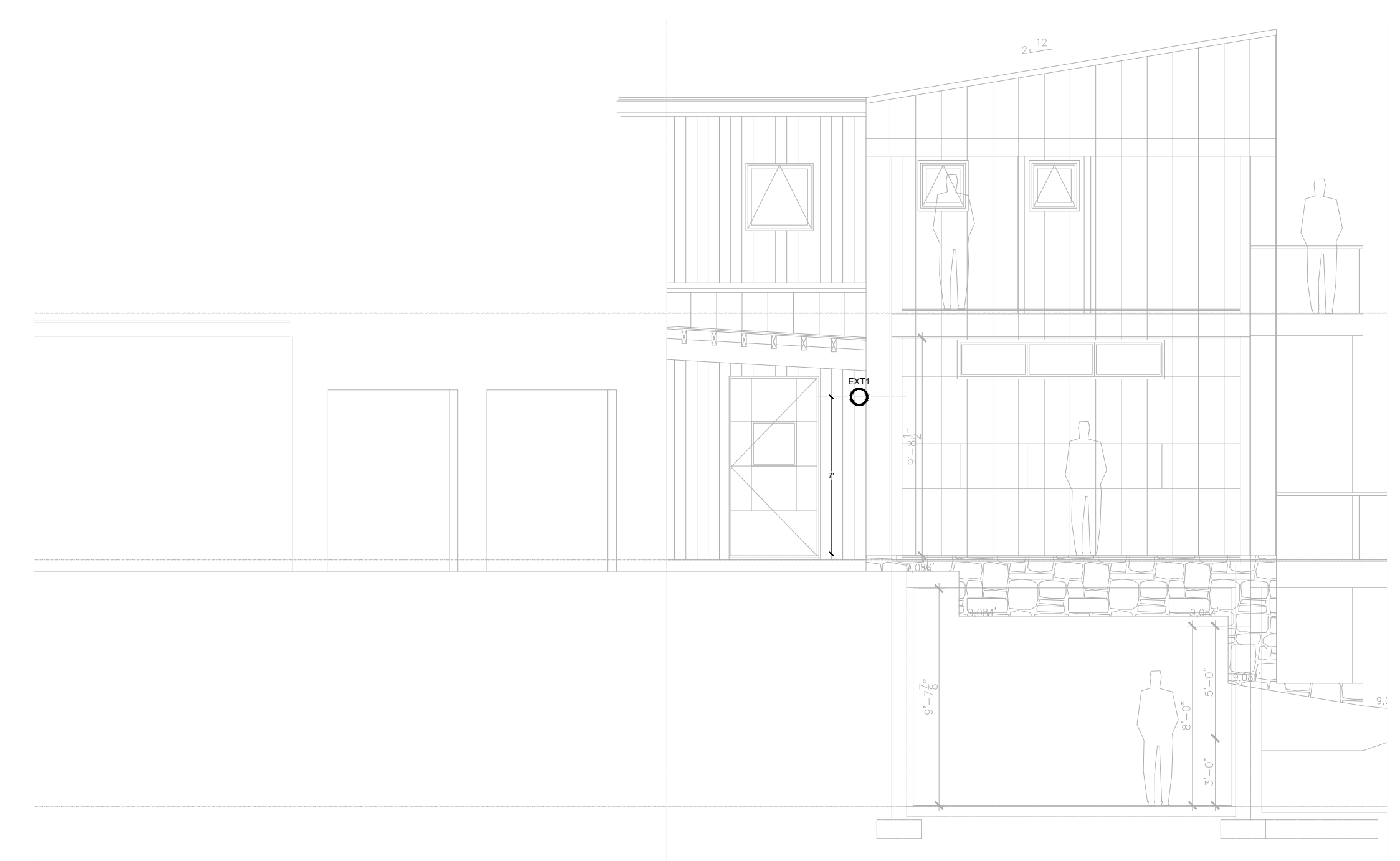

SOUTHEAST ELEV AS OF 3-25-21

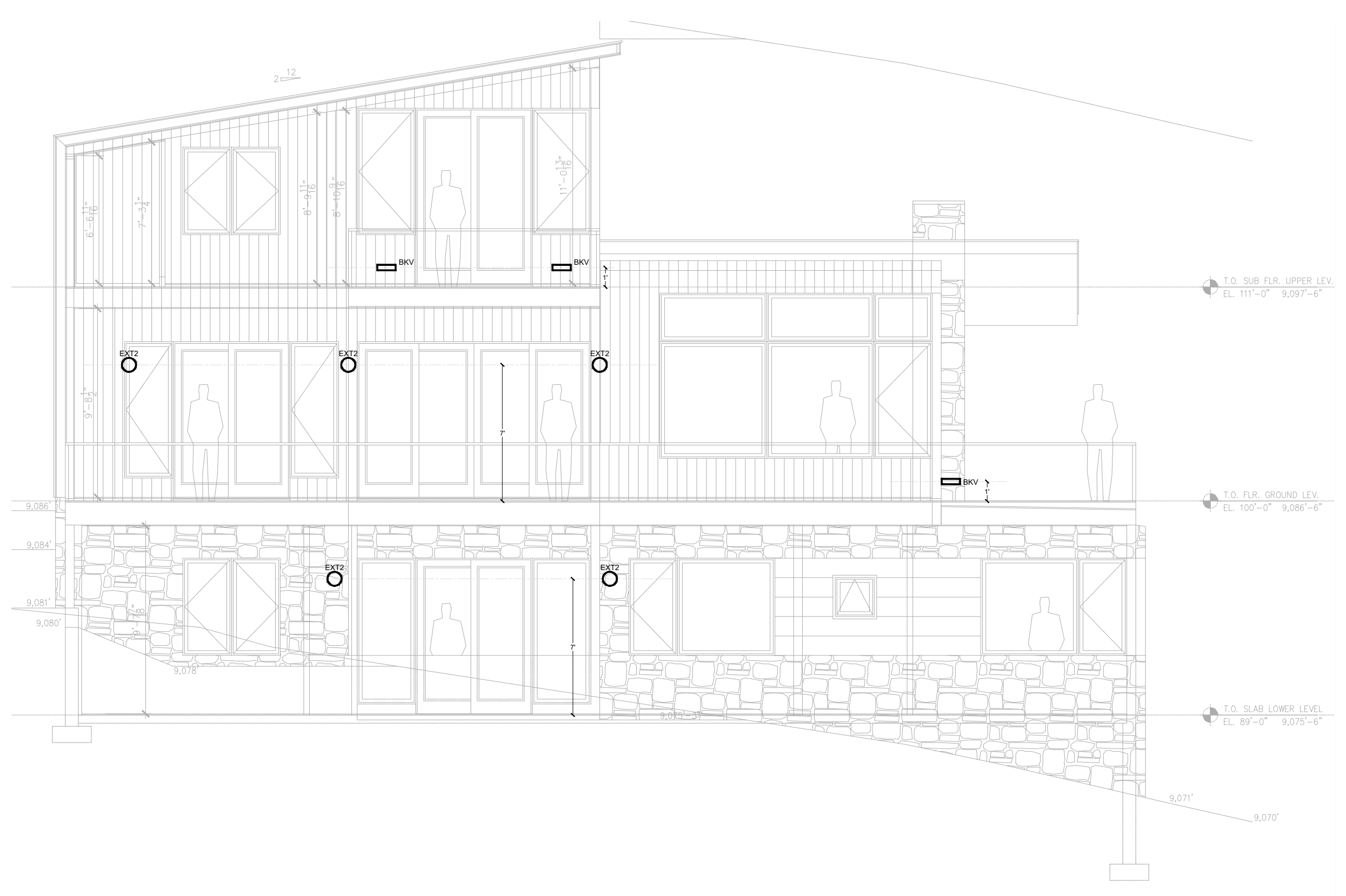

NORTHEAST ELEV AS OF 3-25-21

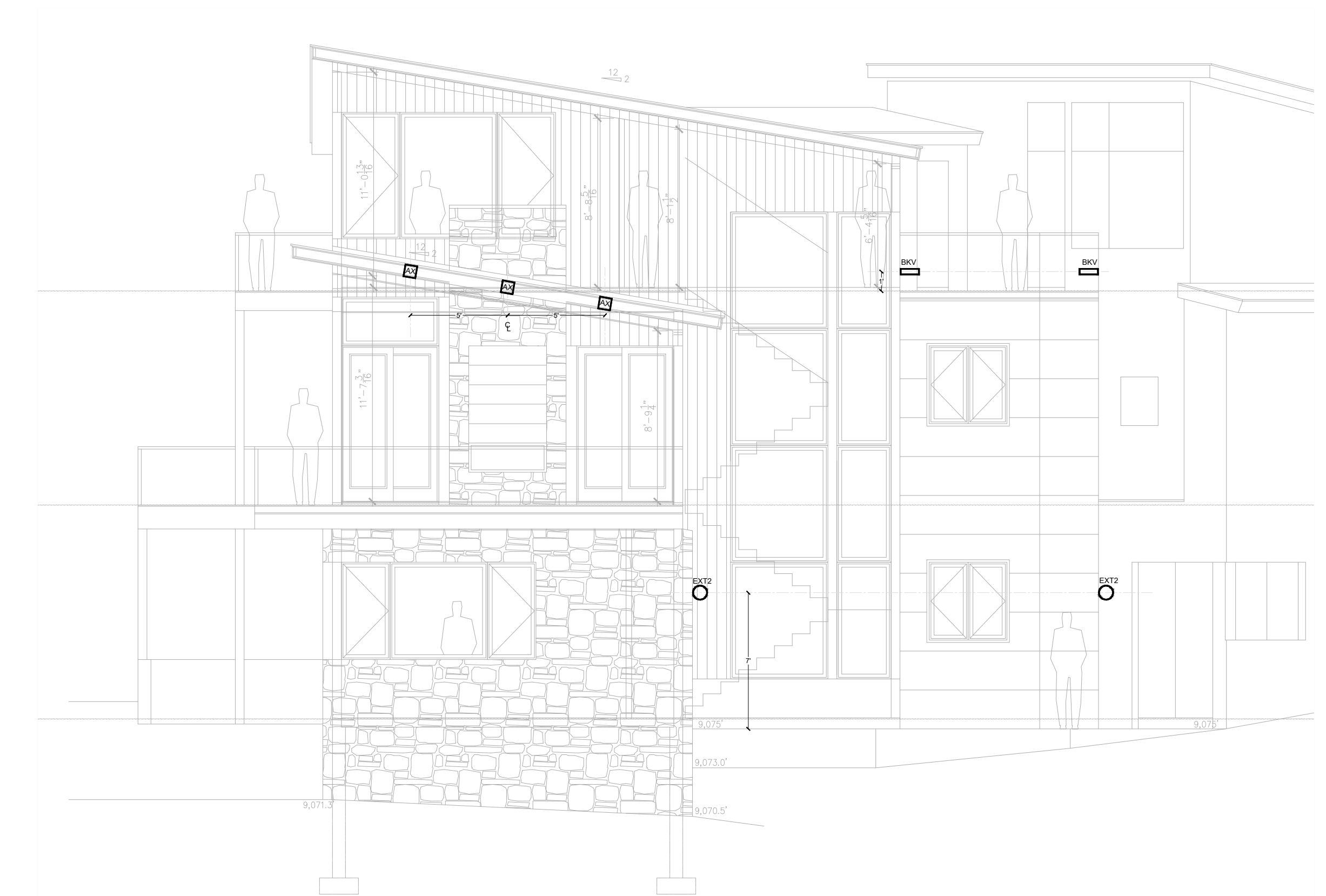

NORTHWEST ELEV AS OF 3-25-21

PROJECT

ADDRESS

SUBMITTAL

SHEET INDEX

DWG TITLE

NARRATIVE

To: Mountain Village Design Review Board
Re: Lot AR-52R Design Review Process Submittal
Date: April 7, 2021

Project Description:

This project is a new single-family residence of 3,970 gross square feet on three floors that is proposed to step down the site as it slopes downhill from south to north.

The proposed access drive and motor court are located at the southeast corner of the lot which is the highest part of the lot. The two-car garage is proposed to be located at the southwest corner of the lot in order to allow the motor court to be located in the southeast corner in order to provide for optimal sun exposure for snow melt.

The proposed massing of the house and the rooflines step up the lot similar to the slope of the lot. The low-pitched shed roofs echo the slope of the lot. The views are primarily to the northwest and northeast and the house and windows open up to these two sides.

The exterior materials are to be a blend of dark and mid gray colors with a small amount of dark browns. The roof is proposed to be standing seam metal roofing with a charcoal color. There will be stone veneer, wood siding and accents of large metal siding.

Thanks for your thoughtful consideration of this proposal.

Regards,

Peter B. Lundeen,
Architect

Lot AR-52R				
123 Adams Way				
Lot size	0.228 acre			
Zone District	Single family			
Zoning Designations	Single family			
Floor Area				
Lower Level	1229.1			
Mechanical		67.5		
Main Level	1056.7			
Garage		625		
Upper Level	991.8			
	3277.6	692.5	3970.1	gross sq. ft.
Lot Coverage				
	3,588.0	sq. ft. footprint		
	0.228	acres		
	43,560	sq. ft. per acre		
	9,940.00	sq. ft. lot size		
	36.10%	lot coverage		
Max Build. Height	34'-11"			
Ave. Bldg. Height	26'-0 3/4"			
Parking				
Required & provided	2 in garge			

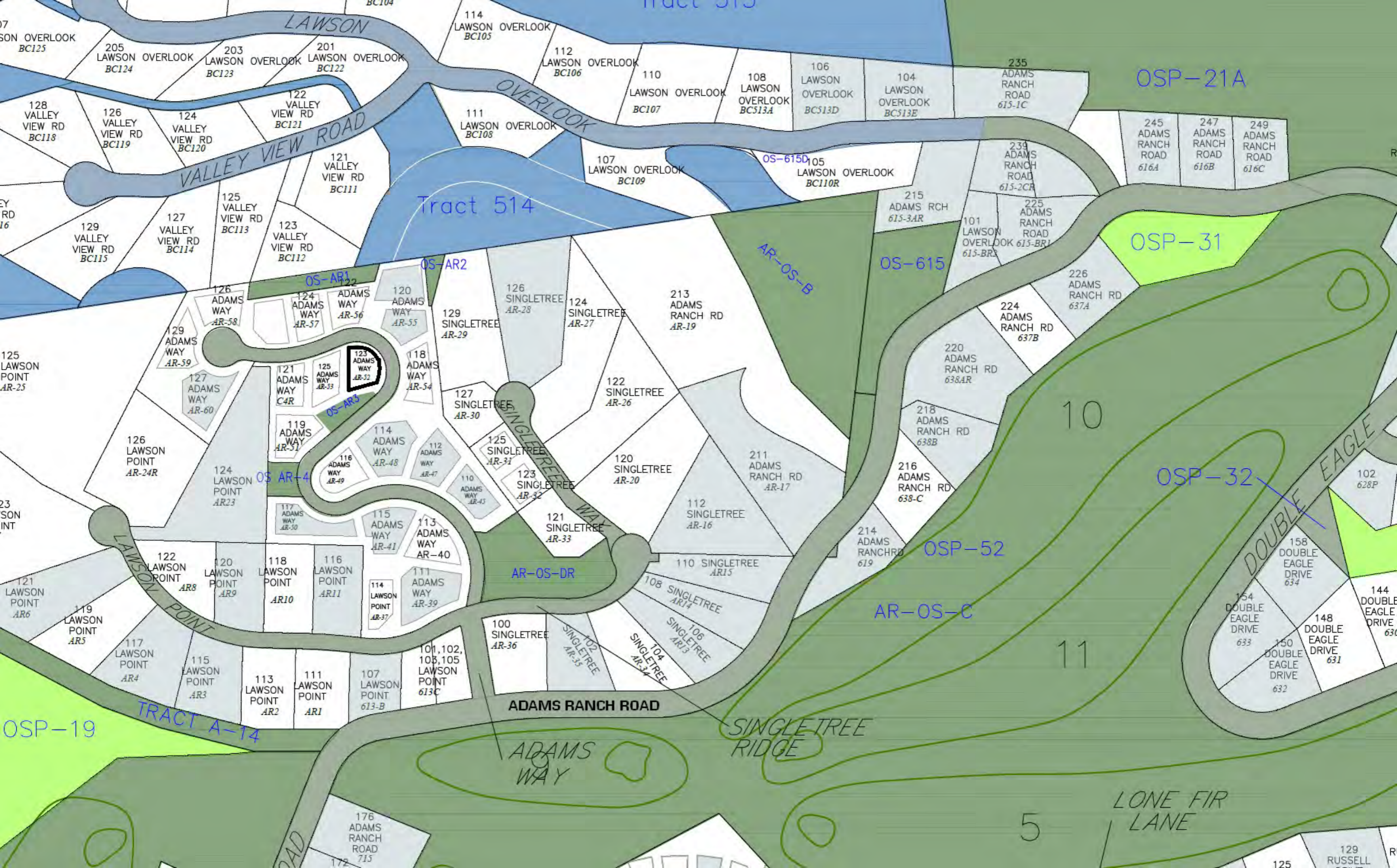

OSP-21A

Tract 514

OSP-31

OSP-32

OSP-52

AR-OS-C

AR-OS-DR

SINGLETREE RIDGE

ADAMS WAY

LONE FIR LANE

OSP-19

TRACT A-14

129 RUSSELL

125

5

11

10

144

DOUBLE EAGLE DRIVE 630

148

DOUBLE EAGLE DRIVE 631

150

DOUBLE EAGLE DRIVE 632

154

DOUBLE EAGLE DRIVE 633

158

DOUBLE EAGLE DRIVE 634

102

DOUBLE EAGLE DRIVE 628P

DOUBLE EAGLE

226

ADAMS RANCH RD 637A

224

ADAMS RANCH RD 637B

220

ADAMS RANCH RD 638A

218

ADAMS RANCH RD 638B

216

ADAMS RANCH RD 638C

214

ADAMS RANCH RD 619

211

ADAMS RANCH RD AR-17

112

SINGLETREE AR-16

120

SINGLETREE AR-20

122

SINGLETREE AR-26

124

SINGLETREE AR-27

126

SINGLETREE AR-28

129

SINGLETREE AR-29

120

ADAMS WAY AR-55

124

ADAMS WAY AR-56

121

ADAMS WAY AR-54

126

ADAMS WAY AR-58

129

ADAMS WAY AR-59

125

ADAMS WAY AR-53

121

ADAMS WAY C4R

127

ADAMS WAY AR-60

126

LAWSON POINT AR-24R

121

SINGLETREE AR-33

123

SINGLETREE AR-32

125

SINGLETREE AR-31

114

ADAMS WAY AR-48

116

ADAMS WAY AR-49

119

ADAMS WAY AR-51

124

LAWSON POINT AR-23

126

LAWSON POINT AR-24R

110

SINGLETREE AR-15

108

SINGLETREE AR-14

100

SINGLETREE AR-36

102

SINGLETREE AR-35

104

SINGLETREE AR-34

106

SINGLETREE AR-13

111

ADAMS WAY AR-39

113

ADAMS WAY AR-40

115

ADAMS WAY AR-41

117

LAWSON POINT AR-4

119

LAWSON POINT AR-5

121

LAWSON POINT AR-6

R

Lot AR-52R Materials



Stone Veneer



Lot AR-52R Materials



Stained or Reclaimed Wood Siding similar to these images



Lot AR-52R Materials



Standing Seam Metal Roofing – Charcoal Grey

Metal siding to be similar but in metal strips – see elevations



Standard Colors



Premium Colors

Berridge premium colors require a nominal surcharge.



Metallic Colors

Berridge metallic colors are premium finishes which require a nominal surcharge.



Natural Metal Finish

Berridge Acrylic-Coated Galvalume® is a coated sheet product that combines the corrosion resistance of Galvalume® steel sheet with a clear, organic resin applied to the top side and bottom side of Galvalume® substrate.



Acrylic-Coated Galvalume®

Please consult the BMC Technical department at Technical@Berridge.com for LEED and Energy Star compliance information. Due to limitations in the printing process, please request actual color chips for accurate color viewing.



COLORS

WOOD TYPES

Choose the wood species that best complements your project's interior.



PREFINISHED PINE INTERIOR COLORS

Custom interior finishes, unfinished or primed and ready-to-paint are also available.



ALUMINUM-CLAD EXTERIOR COLORS

Our low-maintenance EnduraClad® exterior finish resists fading. Take durability one step further with EnduraClad Plus which also resists chalking and corrosion.⁸



Custom colors are also available.

ADDED SECURITY

INSYNCTIVE® TECHNOLOGY

Integrated wireless security sensors maintain aesthetics, streamline security installation and ensure no warranty loss is caused by post-installation drilling. Sensors are compatible with major security panel systems. For more information, go to connectpella.com.

¹ Some Pella products may not meet ENERGY STAR® guidelines in Canada. For more information, contact your local Pella sales representative or go to energystar.gc.ca.

² Based on comparing written limited warranties of leading national wood window and wood patio door brands. See written limited warranty for details, including exceptions and limitations, at installpella.com/warranties or contact Pella Customer Service.

³ Performance ratings vary based on product configuration.

⁴ Color-matched to your product's interior and exterior color.

⁵ Appearance of exterior grille color may vary depending on the Low-E insulating glass selection.

⁶ Flush multi-slide handle is a Pella exclusive design.

⁷ Flush multi-slide handle is not available in Antique Brass, Champagne or Polished Nickel.

⁸ EnduraClad Plus protective finish is not available with all colors. See your local Pella sales representative for availability.

Pella® Architect Series® Contemporary WOOD



Modern wood windows and patio doors featuring smart styling and clean sightlines

Interior



Exterior



- SLEEK DESIGNS AND EXPANSIVE GLASS**
 Achieve that sophisticated style you are looking for with our industry-leading contemporary design. A narrow frame and sash provide more expansive glass and an unobstructed view.
- ENHANCED STYLE OPTIONS**
 Meet your unique project specifications with extensive size options, square grille widths, finishes, wood types and glass options.
- EXPANSIVE CUSTOM CAPABILITIES**
 Work with Pella's dedicated, custom design teams to bring your project vision to life with custom sizes, configurations and installation solutions.
- AUTHENTIC LOOK OF TRUE DIVIDED LIGHT**
 Pella's Integral Light Technology® grilles use the industry's only foam spacer to create the most authentic look of true divided light, by casting a more realistic shadow.
- INTERIOR FINISH OPTIONS**
 From light to dark to modern gray, Pella Architect Series Contemporary wood windows and patio doors are available in an array of on-trend colors. Pine interiors are available in four paints, 11 stains or primed and ready-to-paint.
- MINIMALIST HARDWARE AND MODERN FINISHES**
 Choose from Pella's exclusively designed hardware to complement the other modern fixtures in the home.
- OPTIONAL INTEGRATED SECURITY SENSORS**
 Thoughtfully designed to live discreetly in the frame, wireless sensors with Pella Insynctive® technology maintain aesthetics without voiding the warranty. Sensors compatible with major security panels and home automation systems.
- ENERGY STAR® CERTIFIED¹**
 You don't have to sacrifice performance for design. Pella Architect Series Contemporary products are the most modern windows and doors available with options to meet or exceed ENERGY STAR® in all 50 states.¹
- LONG-LASTING DURABILITY**
 Aluminum-clad exteriors with EnduraClad® finish is applied in an overlapping fashion on windows for exceptional protection. Pella's exclusive EnduraGuard® wood protection is applied after the pieces have been cut and milled, but prior to final assembly.
- THE BEST LIMITED LIFETIME WARRANTY²**
 Pella Architect Series Contemporary products are covered by the best limited lifetime warranty for wood windows and patio doors in the industry.²
- TESTING BEYOND REQUIREMENTS**
 At Pella, our products are tested beyond requirements to help ensure they have long-lasting performance and reduce call-backs for you.

AVAILABLE IN THESE WINDOW & PATIO DOOR STYLES:



Fixed and special shape windows also available.

^{1,2} See back cover for disclosures.

PRODUCT SPECIFICATIONS

WINDOW & PATIO DOOR STYLES	MIN. WIDTH	MIN. HEIGHT	MAX. WIDTH	MAX. HEIGHT	PERFORMANCE CLASS AND GRADE	PERFORMANCE VALUES			FRAME / INSTALL
						U-FACTOR	SHGC	STC	
AWNING	17"	17"	59"	73"	LC30-LC50	0.25-0.30	0.19-0.50	25-31	Block Frame
CASEMENT	17"	17"	35"	73"	LC30-LC50	0.25-0.30	0.19-0.50	25-31	
FIXED CASEMENT	17"	17"	59"	73"	LC30-LC50	0.25-0.30	0.19-0.50	25-31	
IN-SWING HINGED PATIO DOOR (SINGLE)	24"	48"	48"	119-½"	LC40-LC55	0.25-0.29	0.14-0.40	31-32	
IN-SWING HINGED PATIO DOOR (DOUBLE)	48"	79-½"	96"	119-½"	LC40-LC55	0.25-0.29	0.14-0.40	31-32	
OUT-SWING HINGED PATIO DOOR (SINGLE)	24"	48"	48"	119-½"	LC40-LC70	0.25-0.30	0.14-0.39	30-36	
OUT-SWING HINGED PATIO DOOR (DOUBLE)	48"	48"	96"	119-½"	LC40-LC70	0.25-0.30	0.14-0.39	30-36	
SLIDING PATIO DOOR (O)	30-¾"	74"	60-¾"	119-½"	LC30-LC70	0.25-0.31	0.18-0.51	-	
SLIDING PATIO DOOR (OX, XO)	59-¼"	74"	119-½"	119-½"	LC30-LC70	0.25-0.31	0.18-0.51	29-35	
SLIDING PATIO DOOR (OXO)	90"	74"	180"	119-½"	LC30-LC70	0.25-0.31	0.18-0.51	-	
SLIDING PATIO DOOR (OXXO)	116-⅞"	74"	236-⅞"	119-½"	LC30-LC70	0.25-0.31	0.18-0.51	-	
MULTI-SLIDE PATIO DOOR	41-⅞"	50-½"	713-⅝"	119-½"	R15-LC25 ³	0.30-0.36	0.15-0.46	-	For more info visit PellaADM.com
BIFOLD PATIO DOOR	31-¾"	51-½"	312"	119-½"	R15-R25 ³	0.26-0.44	0.13-0.45	-	

WINDOW SIZES AVAILABLE IN 1/8" INCREMENTS

Special sizes available. For more information regarding performance, visit installpella.com/performance. Visit PellaADM.com for specific sizes and glazings tested and for more information regarding frame and installation types.

GRILLES

GRILLES

Choose the look of true divided light or make cleaning easier by selecting grilles-between-the-glass.

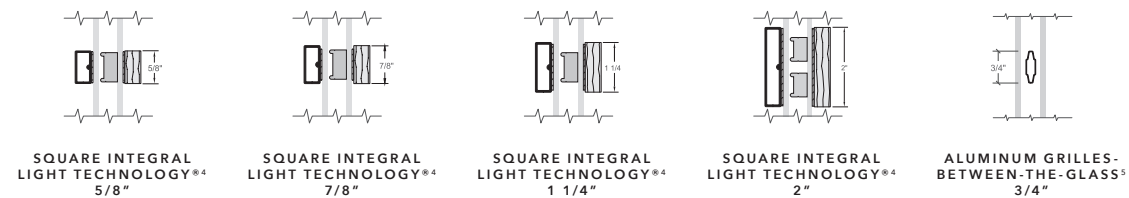

^{3,4,5} See back cover for disclosures.

WINDOW HARDWARE

MODERN COLLECTION

Achieve the ultimate contemporary look with exclusive hardware designed by Pella.



FOLD-AWAY CRANK
Saldo

FINISHES:

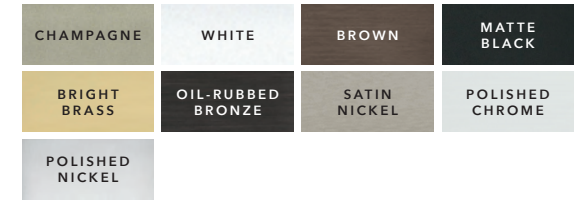

PATIO DOOR HARDWARE

MODERN COLLECTION

Select modern hardware created in collaboration with Baldwin[®] to achieve the ultimate contemporary look with sleek finishes.

BALDWIN



HINGED & BIFOLD PATIO DOOR HANDLE
Spiere



SLIDING & MULTI-SLIDE PATIO DOOR HANDLE
Plazo



MULTI-SLIDE PATIO DOOR HANDLE^{6,7}

FINISHES:



CLASSIC COLLECTION

Choose timeless pieces, created in collaboration with Baldwin Hardware, for a look that will never go out of style.

BALDWIN



HINGED & BIFOLD PATIO DOOR HANDLE
Locus | Virago



SLIDING & MULTI-SLIDE PATIO DOOR HANDLE
Ambrose



MULTI-SLIDE PATIO DOOR HANDLE^{6,7}

FINISHES:

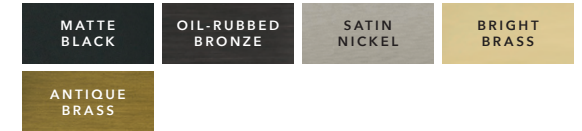

RUSTIC COLLECTION

Stand out with bold looks, created in collaboration with Baldwin hardware, to obtain an utterly unique aesthetic.

BALDWIN



HINGED PATIO DOOR HANDLES
Rustiek | Gusto



SLIDING PATIO DOOR HANDLE
Notus

FINISHES:



ESSENTIAL COLLECTION

Elevate your style and transform your home with elegant selections.



HINGED & BIFOLD PATIO DOOR HANDLE



SLIDING PATIO DOOR HANDLE



MULTI-SLIDE PATIO DOOR HANDLE^{6,7}

FINISHES:

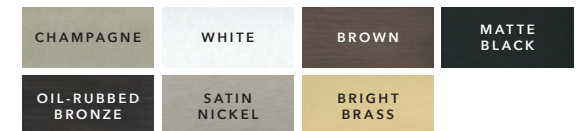

^{6,7} See back cover for disclosures.

CONTEMPORARY

Seals tight and locks easily.

Architect Series® casement windows feature the SureLock® System that reaches out to pull the window sash against the weatherstripping to form a tight seal against drafts, making them more energy-efficient. Plus, Pella's patented Unison Lock System secures casement and awning windows in two places with a single, easy-to-reach handle.



Lasting beauty.

EnduraGuard® wood protection offers advanced protection against the effects of moisture, decay, stains from mold and mildew – as well as termite damage. This proven immersion-treatment method will help ensure that Pella® wood windows and patio doors look and perform beautifully for years.



Pella EnduraGuard wood protection.

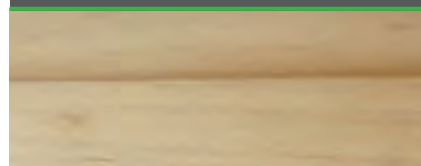

Pella's casement window after 7 months of exposure to moisture.*



Competitor's pressure-treated wood.

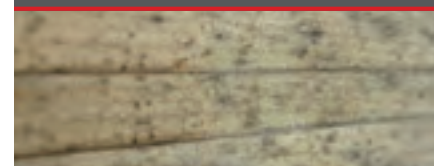

Stain mold present after 7 months of field-testing a competitor's pressure-treated wood.*



The confidence of added protection.

Pella products are backed by some of the strongest warranties in the business. See written limited warranty for details, including exceptions and limitations, at pella.com/warranty.

*For testing purposes, the seal between the bottom rail and the glass was compromised in both casement units tested.

Beautifully functional hardware.

Our exclusive new selection of window hardware and Baldwin® patio door collaborations were designed to add the perfect finishing touch to your Pella® products. Each traditional or contemporary style is available in a diverse palette of striking finishes – allowing for a personal design statement.

HARDWARE STYLES



Styles from the Essential collection shown.

HARDWARE FINISHES

Pella's hardware is available in a variety of complementary finishes for windows and patio doors to help you curate a cohesive look.

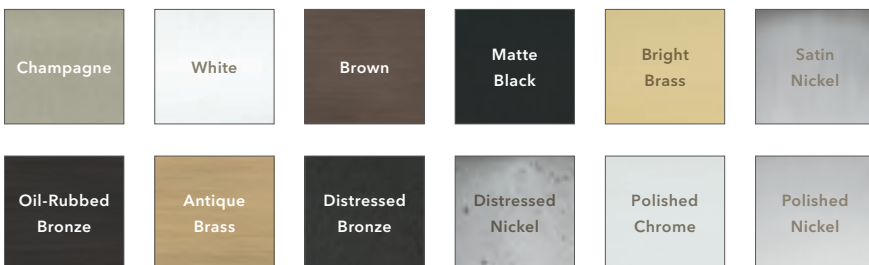

Complement a modern frame.

The sleek design of your Architect Series® contemporary casement window hardware balances the frame's minimalist style with your home's modern aesthetic. And you'll love the convenience of our fold-away cranks.

ALUMINUM-CLAD EXTERIORS

Pella's low-maintenance EnduraClad® exterior finish resists fading, so your windows and patio doors stay looking great for years. Take this beauty and durability one step further with Pella EnduraClad Plus² protective finish that provides exceptional weatherability.

Plus, Pella offers virtually unlimited custom color options for a unique look.



White



Classic
White



Vanilla
Cream



Poplar
White

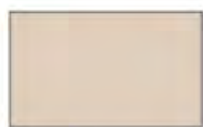

Almond



Sand Dune



Honeysuckle



Tan

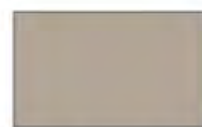

Fossil



Putty



Portobello



Deep Olive



Auburn
Brown



French
Roast



Brown



Summer
Sage



Hemlock



Hartford
Green



Morning
Sky Gray

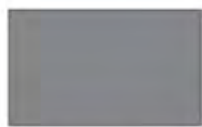

Eldridge
Gray



Iron Ore



Black



Naval



Stormy
Blue



Real Red



Brick Red



Cranberry

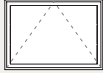

GLAZING PERFORMANCE - TOTAL UNIT

Aluminum-Clad Exterior
Vent Awning and Large Awning



Glazing Thickness	Type of Glazing	NFRC Certified Product #	Glass (mm)		Gap Fill	Performance Values 1				Shaded Areas Meet ENERGY STAR® Performance Criteria in Zones Shown							
			Ext.	Int.		U-Factor	SHGC	VLT	CR	U. S.				Canada 2			
										Zone				ER	Zone		
										N	NC	SC	S				
VENT UNITS																	
11/16"	Clear IG	PEL-N-30-13234-00001	3	3	air	0.45	0.53	0.56	44								
	with grilles-between-the-glass	PEL-N-30-13431-00001				0.44	0.49	0.51	44								
	with integral grilles	PEL-N-30-13438-00001				0.44	0.49	0.51	44								
11/16"	Advanced Low-E IG	PEL-N-30-13229-00002	3	3	argon	0.28	0.26	0.48	61						20		
	with grilles-between-the-glass	PEL-N-30-13423-00002				0.28	0.23	0.43	61						18		
	with integral grilles	PEL-N-30-13426-00002				0.29	0.23	0.43	61								
11/16"	SunDefense™ Low-E IG	PEL-N-30-13230-00002	3	3	argon	0.28	0.19	0.44	61						16		
	with grilles-between-the-glass	PEL-N-30-13424-00002				0.28	0.18	0.40	61								
	with integral grilles	PEL-N-30-13427-00002				0.28	0.18	0.40	61								
11/16"	AdvancedComfort Low-E IG	PEL-N-30-13233-00001	3	3	argon	0.25	0.25	0.47	47						23		
	with grilles-between-the-glass	PEL-N-30-13430-00001				0.25	0.23	0.42	47						22		
	with integral grilles	PEL-N-30-13437-00001				0.27	0.23	0.42	47						20		
11/16"	NaturalSun Low-E IG	PEL-N-30-13231-00002	3	3	argon	0.29	0.47	0.54	61						31		
	with grilles-between-the-glass	PEL-N-30-13425-00002				0.29	0.43	0.49	60						28		
	with integral grilles	PEL-N-30-13428-00002				0.29	0.43	0.49	60						28		
TINTED GLAZING																	
11/16"	Bronze Advanced Low-E IG	PEL-N-30-13271-00001	5	3	argon	0.29	0.23	0.31	59								
	with grilles-between-the-glass	PEL-N-30-13507-00001				0.30	0.21	0.28	59								
	with integral grilles	PEL-N-30-13513-00001				0.30	0.21	0.28	59								
11/16"	Gray Advanced Low-E IG	PEL-N-30-13272-00001	5	3	argon	0.29	0.21	0.26	59								
	with grilles-between-the-glass	PEL-N-30-13508-00001				0.30	0.19	0.24	59								
	with integral grilles	PEL-N-30-13514-00001				0.30	0.19	0.24	59								
11/16"	Green Advanced Low-E IG	PEL-N-30-13273-00001	5	3	argon	0.29	0.26	0.42	59								
	with grilles-between-the-glass	PEL-N-30-13509-00001				0.30	0.24	0.38	59								
	with integral grilles	PEL-N-30-13515-00001				0.30	0.24	0.38	59								
HIGH ALTITUDE GLAZING																	
11/16"	Advanced Low-E IG	PEL-N-30-13235-00001	3	3	air	0.32	0.26	0.48	55								
	with grilles-between-the-glass	PEL-N-30-13432-00001				0.32	0.24	0.43	55								
	with integral grilles	PEL-N-30-13439-00001				0.32	0.24	0.43	55								
11/16"	SunDefense Low-E IG	PEL-N-30-13236-00001	3	3	air	0.31	0.20	0.44	56								
	with grilles-between-the-glass	PEL-N-30-13433-00001				0.32	0.18	0.40	56								
	with integral grilles	PEL-N-30-13440-00001				0.32	0.18	0.40	56								
11/16"	AdvancedComfort Low-E IG	PEL-N-30-13238-00001	3	3	air	0.28	0.25	0.47	43						19		
	with grilles-between-the-glass	PEL-N-30-13435-00001				0.28	0.23	0.42	43						18		
	with integral grilles	PEL-N-30-13442-00001				0.29	0.23	0.42	43								
11/16"	NaturalSun Low-E IG	PEL-N-30-13237-00001	3	3	air	0.32	0.47	0.54	55						27		
	with grilles-between-the-glass	PEL-N-30-13434-00001				0.33	0.43	0.49	55								
	with integral grilles	PEL-N-30-13441-00001				0.33	0.43	0.49	55								

R-Value = 1/U-Factor
SHGC = Solar Heat Gain Coefficient
VLT % = Visible Light Transmission
CR = Condensation Resistance
ER = Canadian Energy Rating

(1) Glazing performance values are calculated for Pine using NFRC 100, NFRC 200 and NFRC 500. Thermal performance of other wood species may vary. ENERGY STAR® values are updated to 2016 (Version 6) criteria.
(2) The values shown are based on Canada's updated ENERGY STAR® 2015 initiative.
Based on unit size, some products will use 2.5 mm glass that will have equivalent or improved performance from what is shown.
See the Product Performance section for more detailed information or visit www.energystar.gov for Energy Star guidelines.

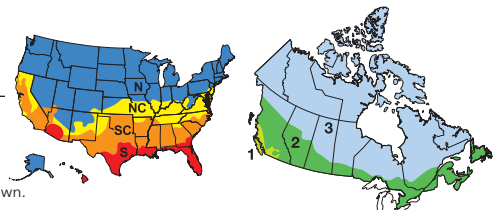

A contemporary reinterpretation of the classic barn light, ours has a sleek sensibility that transcends its utilitarian tradition. Held aloft by an elegant scrolling arm, the slender frame encircles a spare, open grill and an inset LED-powered disk that radiates a diffuse glow.

FINISH OPTIONS

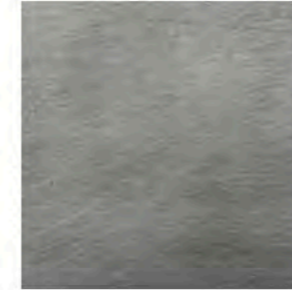

Pewter

Lacquered
Burnished Brass

Bronze

DETAILS

- Burnished Brushed Aluminum finish is handcrafted of aluminum; all other finishes are handcrafted of solid brass
- Lacquered Burnished Brass finish has been lacquered to preserve its color
- Bronze finish is applied to live solid brass and will naturally darken and patina over time; a light coat of wax protects the finish and allows it to age gracefully to a darker patina. The finish will darken faster in areas where the fixture is handled; the use of gloves is recommended.
- Fitted with an integrated 18W LED panel; 1250 lumens
- LED life span 25,000 hours; color temperature 2700K
- LED panel is replaceable; professional installation required
- Dimmer switch compatible; can only be used with an ELV trailing-edge dimmer
- 110-120V manufactured to US standards for US and Canadian markets. Requires outlet adapter and voltage converter for use internationally.



Shown in Bronze.

GRAHAM SCONCE

EXT 1

Starting at

~~\$895~~ Regular

\$715 Final Sale

\$572 Member

A contemporary reinterpretation of the classic barn light, ours has a sleek sensibility that transcends its utilitarian tradition. Held aloft by an elegant scrolling arm, the slender frame encircles a spare, open grill and an inset LED-powered disk that radiates a diffuse glow.

FINISH OPTIONS



Pewter



Lacquered
Burnished Brass

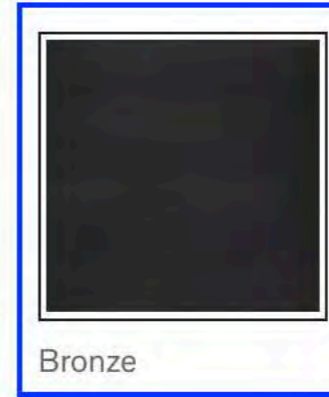

Bronze

DETAILS



DIMENSIONS



16" SCONCE INSTALLATION INSTRUCTIONS



14" SCONCE INSTALLATION INSTRUCTIONS



Wall luminaires with light in downward direction

Application

Designed to provide down lighting effects for interior and exterior locations featuring narrow beam light distribution.

Materials

Luminaire housing constructed of die-cast marine grade, copper free ($\leq 0.3\%$ copper content) A360.0 aluminum alloy
 Clear safety glass
 Reflector made of pure anodized aluminum
 Silicone applied robotically to casting, plasma treated for increased adhesion
 High temperature silicone gasket
 Mechanically captive stainless steel fasteners

NRTL listed to North American Standards, suitable for wet locations
 Protection class IP64
 Weight: 3.5lbs

Electrical

Operating voltage	120-277VAC
Minimum start temperature	-40° C
LED module wattage	4.0W
System wattage	6.0W
Controllability	0-10V dimmable
Color rendering index	Ra > 80
Luminaire lumens	318 lumens (3000K)
LED service life (L70)	60,000 hours

LED color temperature

4000K - Product number + **K4 (EXPRESS)**
 3500K - Product number + **K35**
 3000K - Product number + **K3 (EXPRESS)**
2700K - Product number + **K27**
 Amber - Product number + **AMB**

Wildlife friendly amber LED - Optional

Luminaire is optionally available with a narrow bandwidth, amber LED source (585-600nm) approved by the FWC. This light output is suggested for use within close proximity to sea turtle nesting and hatching habitats. Electrical and control information may vary from standard luminaire.

LED module wattage	4.5W (Amber)
System wattage	8.8W (Amber)
Luminaire lumens	90 lumens (Amber)

BEGA can supply you with suitable LED replacement modules for up to 20 years after the purchase of LED luminaires - see website for details

Finish

All BEGA standard finishes are matte, textured polyester powder coat with minimum 3 mil thickness.

Available colors	Black (BLK)	White (WHT)	RAL:
	Bronze (BRZ)	Silver (SLV)	CUS:



Wall luminaires with light in downward direction					
	LED	β	A	B	C
33 580	4.0W	23°	4 3/8	7 1/2	5

β = Beam angle

BEGA 1000 BEGA Way, Carpinteria, CA 93013 (805) 684-0533 info@bega-us.com

Due to the dynamic nature of lighting products and the associated technologies, luminaire data on this sheet is subject to change at the discretion of BEGA North America. For the most current technical data, please refer to bega-us.com
 © copyright BEGA 2018 Updated 03/20/19

Type:

BEGA Product:

Project:

Modified:



Model: WL-LED200

LEDme® Step Light

WAC LIGHTING

Responsible Lighting®

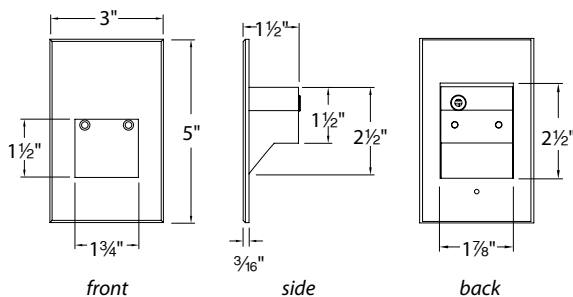

Fixture Type:

BKV

Catalog Number:

Project:

Location:

PRODUCT DESCRIPTION

Vertical rectangle LEDme® Step Light. Designed for safety and style on stairways, patios, decks, balcony areas, walkways and building perimeters. Features an architectural design. Energy efficient for long-lasting indoor and outdoor lighting solutions. Creates an attractive, romantic impression at night.

FEATURES

- 316 marine grade cast stainless steel (SS) available
- Direct wiring, no driver needed
- Low profile, flush to wall aesthetics with no visible hardware
- Turtle friendly (AM, RD colors)
- 40,000 hour rated life
- Balanced lighting, free of shadows with minimum glare
- Up to 200 fixtures can be connected in parallel
- Replaceable LED module
- 5 year WAC Lighting product warranty

SPECIFICATIONS

Construction: Die-cast aluminum or 316 marine grade cast stainless steel

Power: Direct wiring, no remote driver needed. Input voltage: 120V or 277V AC 50/60Hz

Light Source: 3000K CCT Samsung HV-AC High Power LED, CRI: 85
Optional color lenses. Total power consumption of 3.9W

Mounting: Fits into 2" x 4" J-Box with minimum inside dimensions of 3" L x 2" W x 2" H

Includes bracket for J-Box mount. See next page for spacing recommendations

Dimming: Dim to 10% with electronic low voltage (ELV) dimmer
Approved dimmers: Lutron Skylark SELV-300P-WH and Leviton Vizia VPE04

Standards: IP66, UL & cUL Listed for wet locations

FIXTURE PERFORMANCE

Model #	Lm	Model #	Lm	Model #	Lm	Model #	Lm	Model #	Lm
WL-LED200-C-SS	36	WL-LED200-C-BK	27	WL-LED200-C-WT	63	WL-LED200-C-BN	27	WL-LED200-C-BZ	29
WL-LED200-AM-SS	21	WL-LED200-AM-BK	16	WL-LED200-AM-WT	31	WL-LED200-AM-BN	16	WL-LED200-AM-BZ	17
WL-LED200-RD-SS	2	WL-LED200-RD-BK	2	WL-LED200-RD-WT	4	WL-LED200-RD-BN	2	WL-LED200-RD-BZ	2
WL-LED200-BL-SS	4	WL-LED200-BL-BK	3	WL-LED200-BL-WT	7	WL-LED200-BL-BN	3	WL-LED200-BL-BZ	4
WL-LED200F-C-SS	33	WL-LED200F-C-BK	23	WL-LED200F-C-WT	54	WL-LED200F-C-BN	23	WL-LED200F-C-BZ	26
WL-LED200F-AM-SS	18	WL-LED200F-AM-BK	13	WL-LED200F-AM-WT	27	WL-LED200F-AM-BN	13	WL-LED200F-AM-BZ	14
WL-LED200F-RD-SS	2	WL-LED200F-RD-BK	1.5	WL-LED200F-RD-WT	3	WL-LED200F-RD-BN	1.5	WL-LED200F-RD-BZ	2
WL-LED200F-BL-SS	4	WL-LED200F-BL-BK	3	WL-LED200F-BL-WT	4	WL-LED200F-BL-BN	3	WL-LED200F-BL-BZ	3

ORDER NUMBER

Model #	Color	Finish
WL-LED200 120V	C White 3000K	SS Stainless Steel
WL-LED200F 277V	AM Amber 610nm	BK Black
	RD Red 640nm	WT White
	BL Blue 450nm	BN Brushed Nickel
		BZ Bronze

FINISHES

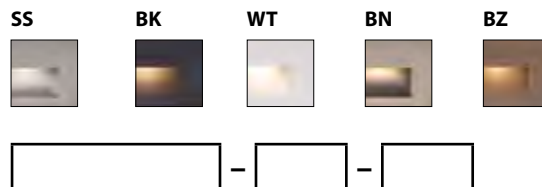

Example: WL-LED200F-AM-BZ

WAC Lighting

www.waclighting.com
Phone (800) 526.2588 • Fax (800) 526.2585

Headquarters/Eastern Distribution Center

44 Harbor Park Drive • Port Washington, NY 11050
Phone (516) 515.5000 • Fax (516) 515.5050

Western Distribution Center

1750 Archibald Avenue • Ontario, CA 91760
Phone (800) 526.2588 • Fax (800) 526.2585

Model: WL-LED200

LEDme® Step Light

WAC LIGHTING

Responsible Lighting®

Spacing Recommendations for Optimal Light Distribution

Corridors / Hallways

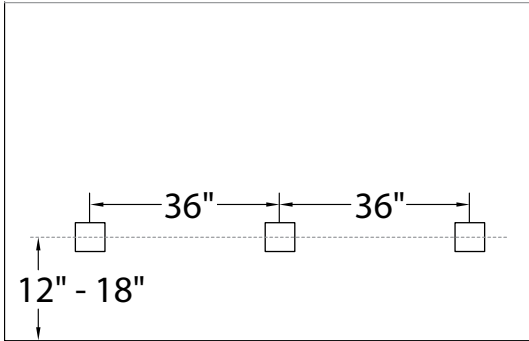

Stairs - Wall Mount

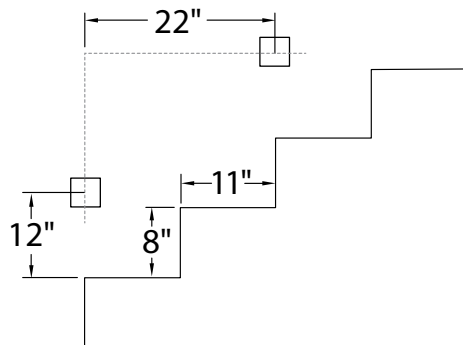

Stairs - Step Mount

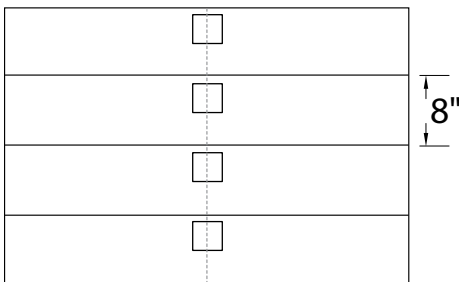

Mount in center of stair as close to the upper tread as possible.
For best results use one light per step for steps narrower than 5'.

3" Eco-Downlight

IC Air-Tight Adjustable New Construction Housing

Round or Square

Wattage	CCT	Delivered Lumens	Efficacy
13W	2700K	1000lm	77lpw
13W	3000K	1200lm	92lpw
21W	2700K	1700lm	81lpw
21W	3000K	1850lm	88lpw
21W	3500K	2000lm	95lpw

Lumens will vary depending on optic, finish & trim type

Dimensions

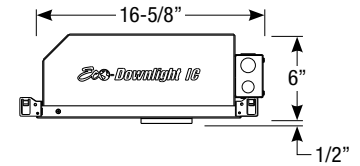
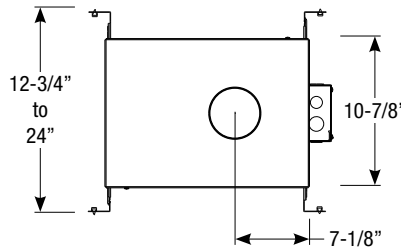
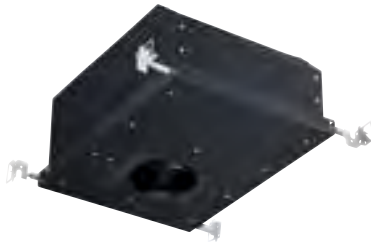

Ceiling Cut-out: 3-7/8" Ø

LED Light Engine

- 13W LED with 2700K or 3000K @ 90 CRI
- 21W LED with 2700K, 3000K or 3500K @ 90 CRI
- 2 SDCM binning
- 50,000 hours at 70% lumen maintenance (L70)

Field Replaceable Dimming Driver

- 13W Low power density (LPD) housings include an universal ELV / Triac driver with 120-277V input
- 21W housings are available with remote Lutron Hi-Lume® or universal 0-10V / ELV / Triac driver

Optics

50° flood optic included (10°, 30° and 80° optic are available, must specify)

Adjustability

359° horizontal rotation and 45° tilt

Housing

- Aluminum air-tight housing with black power coat finish (Note: polycell spray-in foam insulation must be kept 3" from housing)
- Cold rolled steel junction box with black anodized finish, (4) 1/2" and (4) 3/4" trade size knockouts

Mounting

- Includes (2) galvanized steel adjustable bar hangers
- Accommodates ceiling thickness up to 1"

Trim

- Available in round or square aluminum trim, consult factory for custom finishes
- Available in open reflector, baffle, shower or wall wash trims
- Flush mount adapter and trimless mud plate available

Accessories

Accommodates (2) accessories, a media holder is required.

Emergency

Remote inverter operates for 90 minutes with remote test switch available, requires above ceiling access.

Listing/Warranty

- Five (5) year limited warranty
- UL listed to US and Canadian standards for damp locations (wet location when used with shower trim)
- Meets ASTM E283 standards
- CEC (Title 24) Listed when used with reflector or baffle



Housing Order Matrix (Example: EDL-ADJ-27-5)

Installation Type	CCT / CRI	Rev	Wattage / Driver
EDL-ADJ (IC)	<input type="checkbox"/> -27 (2700K / 90 CRI)	-5	<input type="checkbox"/> (blank) (21W / ERP, Universal Dim, Triac/ELV/0-10V 10% 120-277V)
	<input type="checkbox"/> -30 (3000K / 90 CRI)		<input type="checkbox"/> -LR1 (21W / Remote Lutron Hi-Lume® 2-Wire 1% 120V)
	<input type="checkbox"/> -35* (3500K / 90 CRI)		<input type="checkbox"/> -LPD* (13W / ERP, Universal Dim, Triac/ELV 10% 120-277V)

1. Not available with 13W LPD driver

2. Available in 2700K and 3000K only

Accessories (Note: Media holder required)

- EDL-MHLDR-4** (Media Holder - required)
- EDL-FT-4** (Frosted Lens)
- EDL-MP-4** (Solite Lens)
- EDL-CL-4** (Clear Lens)
- EDL-LN-4** (Linear Spread Lens)

Optics

- EDL-10-OPTIC-5** (10° Spot)
- EDL-30-OPTIC-4** (30° Narrow Flood)
- EDL-50-OPTIC-4** (50° Flood)
- EDL-80-OPTIC-4** (80° Wide Flood)

Emergency

- EM-1000** (25W LED Remote Inverter)
- EM-1002** (10W LED Remote Emergency Driver)
- EM-1003** (35W LED Remote Inverter)
- EM-1004** (50W LED Remote Inverter)

3" Eco-Downlight Adjustable Accent Reflector

IC Air-Tight Adjustable New Construction Housing

Round or Square

Catalog #:

Type:

Project:

Date:

Notes:

Adjustable Accent Reflector Trim Order Matrix (Example: EDL-1302-4)

Series	Aperture / Finish	Rev
EDL	<input type="checkbox"/> -1300 (Round / Clear Alzak Reflector / White Flange)	-4
	<input type="checkbox"/> -1301 (Round / Black Alzak Reflector / White Flange)	
	<input type="checkbox"/> -1302 (Round / Clear Alzak Reflector / Satin Aluminum Flange)	
	<input type="checkbox"/> -1303 (Round / Black Alzak Reflector / Satin Aluminum Flange)	
	<input type="checkbox"/> -1304 (Round / Haze Reflector / White Flange)	
	<input type="checkbox"/> -1305 (Round / Haze Reflector / Satin Aluminum Flange)	
	<input type="checkbox"/> -1306 (Round / White Reflector / White Flange)	
	<input type="checkbox"/> -1307 (Round / Bronze Reflector / Bronze Flange)	
	<input type="checkbox"/> -7000 ¹ (Round / White Reflector / Trimless)	
	<input type="checkbox"/> -7001 ¹ (Round / Satin Aluminum Reflector / Trimless)	
	<input type="checkbox"/> -7002 ¹ (Round / Bronze Reflector / Trimless)	
	<input type="checkbox"/> -7003 ¹ (Round / Black Reflector / Trimless)	
	<input type="checkbox"/> -1500 (Square / White Reflector / White Flange)	
	<input type="checkbox"/> -1501 (Square / Black Reflector / White Flange)	
	<input type="checkbox"/> -1502 (Square / Haze Reflector / White Flange)	
	<input type="checkbox"/> -1503 (Square / Black Reflector / Satin Aluminum Flange)	
	<input type="checkbox"/> -1504 (Square / Haze Reflector / Satin Aluminum Flange)	
	<input checked="" type="checkbox"/> -1505 (Square / Bronze Reflector / Bronze Flange)	

1. Requires trimless mud plate, must specify

Dimensions

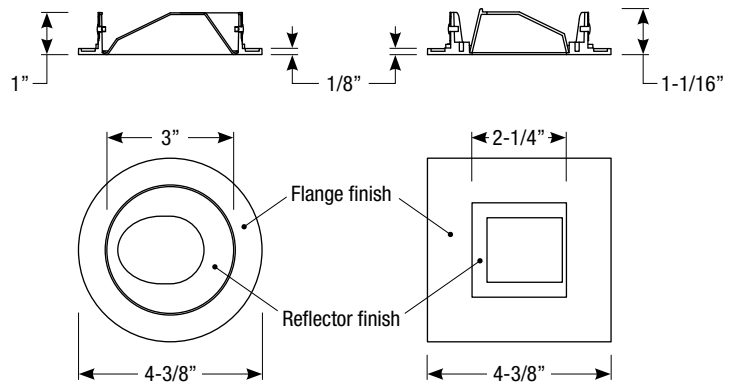

Note: Adjustable accent reflector allows full adjustability

Flush Mount Adapter

- EDL-RD-FMA (Round Flush Mount Adapter)
- EDL-SQ-FMA (Square Flush Mount Adapter)

Trimless Mud Plate

- EDL-RD-TR-4 (Round Trimless Mud Plate)

EDL-1300-4
Clear Alzak Reflector
White Flange



EDL-1301-4
Black Alzak Reflector
White Flange



EDL-1302-4
Clear Alzak Reflector
Satin Aluminum Flange



EDL-1303-4
Black Alzak Reflector
Satin Aluminum Flange



EDL-1304-4
Haze Reflector
White Flange



EDL-1305-4
Haze Reflector
Satin Aluminum Flange



EDL-1306-4
White Reflector
White Flange



EDL-1307-4
Bronze Reflector
Bronze Flange



EDL-7000-4
White Reflector

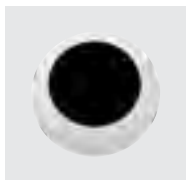

EDL-7001-4
Satin Aluminum Reflector

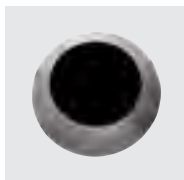

EDL-7002-4
Bronze Reflector



EDL-7003-4
Black Alzak Reflector

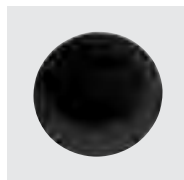

EDL-1500-4
White Reflector
White Flange

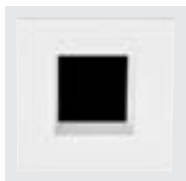

EDL-1501-4
Black Reflector
White Flange



EDL-1502-4
Haze Reflector
White Flange



EDL-1503-4
Black Reflector
Satin Aluminum Flange



EDL-1504-4
Haze Reflector
Satin Aluminum Flange



EDL-1505-4
Bronze Reflector
Bronze Flange

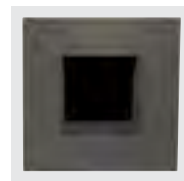

Revised 01/08/18

3" Eco-Downlight Open Reflector

IC Air-Tight Adjustable New Construction Housing

Round or Square

Catalog #:

Type:

Project:

Date:

Notes:

Open Reflector Trim Order Matrix (Example: EDL-1002-4)

Series	Aperture / Finish	Rev
EDL	<input type="checkbox"/> -1000 (Round / Clear Alzak Reflector / White Flange)	-4
	<input type="checkbox"/> -1001 (Round / Black Alzak Reflector / White Flange)	
	<input type="checkbox"/> -1002 (Round / Clear Alzak Reflector / Satin Aluminum Flange)	
	<input type="checkbox"/> -1003 (Round / Black Alzak Reflector / Satin Aluminum Flange)	
	<input type="checkbox"/> -1004 (Round / Haze Reflector / White Flange)	
	<input type="checkbox"/> -1005 (Round / Haze Reflector / Satin Aluminum Flange)	
	<input type="checkbox"/> -1006 (Round / White Reflector / White Flange)	
	<input type="checkbox"/> -1007 (Round / Bronze Reflector / Bronze Flange)	
	<input type="checkbox"/> -5000 ¹ (Round / White Reflector / Trimless)	
	<input type="checkbox"/> -5001 ¹ (Round / Satin Aluminum Reflector / Trimless)	
	<input type="checkbox"/> -5002 ¹ (Round / Bronze Reflector / Trimless)	
	<input type="checkbox"/> -5003 ¹ (Round / Black Reflector / Trimless)	
	<input type="checkbox"/> -2000 (Square / White Reflector / White Flange)	
	<input type="checkbox"/> -2001 (Square / Black Reflector / White Flange)	
	<input type="checkbox"/> -2002 (Square / Haze Reflector / White Flange)	
	<input type="checkbox"/> -2003 (Square / Black Reflector / Satin Aluminum Flange)	
	<input type="checkbox"/> -2004 (Square / Haze Reflector / Satin Aluminum Flange)	
	<input type="checkbox"/> -2005 (Square / Bronze Reflector / Bronze Flange)	

1. Requires trimless mud plate, must specify

Dimensions

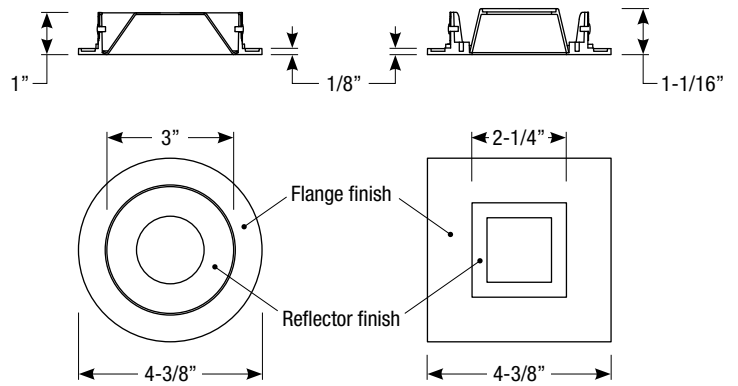

Note: Open reflector does not allow adjustable mechanism to tilt

Flush Mount Adapter

- EDL-RD-FMA (Round Flush Mount Adapter)
- EDL-SQ-FMA (Square Flush Mount Adapter)

Trimless Mud Plate

- EDL-RD-TR-4 (Round Trimless Mud Plate)

EDL-1000-4
Clear Alzak Reflector
White Flange



EDL-1001-4
Black Alzak Reflector
White Flange



EDL-1002-4
Clear Alzak Reflector
Satin Aluminum Flange



EDL-1003-4
Black Alzak Reflector
Satin Aluminum Flange

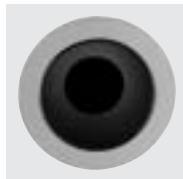

EDL-1004-4
Haze Reflector
White Flange



EDL-1005-4
Haze Reflector
Satin Aluminum Flange

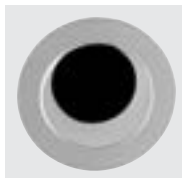

EDL-1006-4
White Reflector
White Flange



EDL-1007-4
Bronze Reflector
Bronze Flange



EDL-5000-4
White Reflector

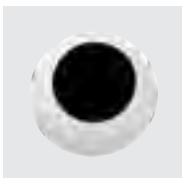

EDL-5001-4
Satin Aluminum Reflector

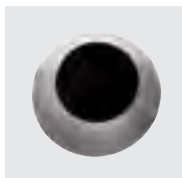

EDL-5002-4
Bronze Reflector

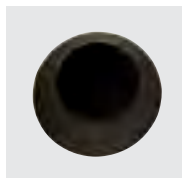

EDL-5003-4
Black Alzak Reflector

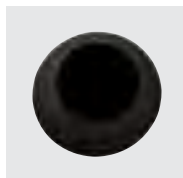

EDL-2000-4
White Reflector
White Flange

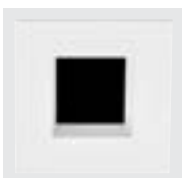

EDL-2001-4
Black Reflector
White Flange



EDL-2002-4
Haze Reflector
White Flange

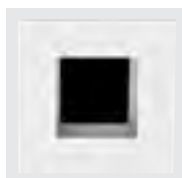

EDL-2003-4
Black Reflector
Satin Aluminum Flange

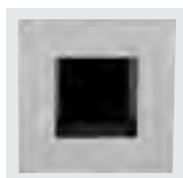

EDL-2004-4
Haze Reflector
Satin Aluminum Flange



EDL-2005-4
Bronze Reflector
Bronze Flange

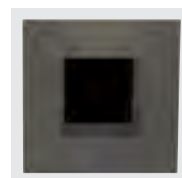

Revised 01/08/18

3" Eco-Downlight Adjustable Baffle

IC Air-Tight Adjustable New Construction Housing

Round or Square

Catalog #:

Type:

Project:

Date:

Notes:

Adjustable Baffle Trim Order Matrix (Example: EDL-1402-4)

Series	Aperture / Finish	Rev
EDL	<input type="checkbox"/> -1400 (Round / White Baffle / White Flange)	-4
	<input type="checkbox"/> -1401 (Round / Black Baffle / White Flange)	
	<input type="checkbox"/> -1402 (Round / Black Baffle / Satin Aluminum Flange)	
	<input type="checkbox"/> -1403 (Round / Bronze Baffle / Bronze Flange)	
	<input type="checkbox"/> -7100 ¹ (Round / White Baffle / Trimless)	
	<input type="checkbox"/> -7101 ¹ (Round / Satin Aluminum Baffle / Trimless)	
	<input type="checkbox"/> -7102 ¹ (Round / Bronze Baffle / Trimless)	
	<input type="checkbox"/> -7103 ¹ (Round / Black Baffle / Trimless)	
	<input type="checkbox"/> -1600 (Square / White Baffle / White Flange)	
	<input type="checkbox"/> -1601 (Square / Black Baffle / White Flange)	
	<input type="checkbox"/> -1602 (Square / Black Baffle / Satin Aluminum Flange)	
	<input type="checkbox"/> -1603 (Square / Bronze Baffle / Bronze Flange)	

1. Requires trimless mud plate, must specify

Dimensions

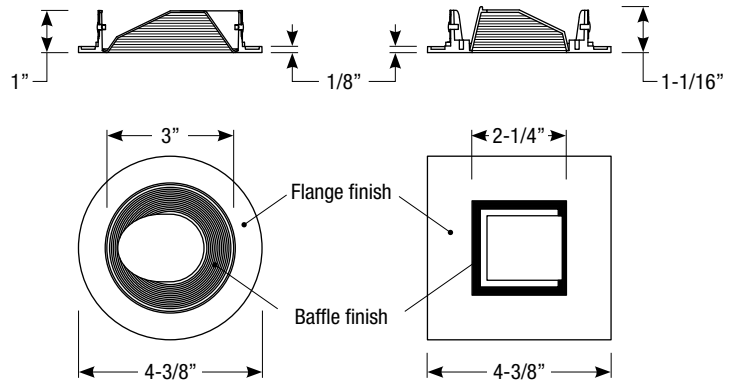

Flush Mount Adapter

- EDL-RD-FMA (Round Flush Mount Adapter)
- EDL-SQ-FMA (Square Flush Mount Adapter)

Trimless Mud Plate

- EDL-RD-TR-4 (Round Trimless Mud Plate)

Note: Adjustable baffle allows full adjustability

Trim Finishes

EDL-1400-4
White Baffle
White Flange



EDL-1401-4
Black Baffle
White Flange

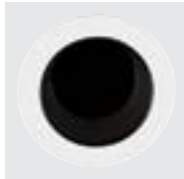

EDL-1402-4
Black Baffle
Satin Aluminum Flange



EDL-1403-4
Bronze Baffle
Bronze Flange

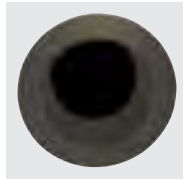

EDL-7100-4
White Baffle

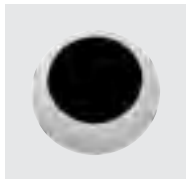

EDL-7101-4
Satin Aluminum Baffle

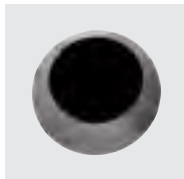

EDL-7102-4
Bronze Baffle

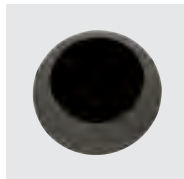

EDL-7103-4
Black Baffle

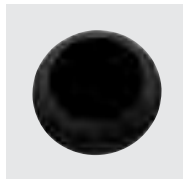

EDL-1600-4
White Baffle
White Flange

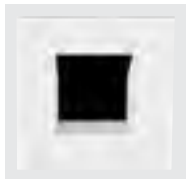

EDL-1601-4
Black Baffle
White Flange



EDL-1602-4
Black Baffle
Satin Aluminum Flange



EDL-1603-4
Bronze Baffle
Bronze Flange

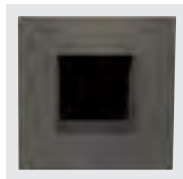

Revised 01/08/18

3" Eco-Downlight Baffle Downlight

IC Air-Tight Adjustable New Construction Housing

Round or Square

Catalog #:

Type:

Project:

Date:

Notes:

Baffle Downlight Trim Order Matrix (Example: EDL-1102-4)

Series	Aperture / Finish	Rev
EDL	<input type="checkbox"/> -1100 (Round / White Baffle / White Flange)	-4
	<input type="checkbox"/> -1101 (Round / Black Baffle / White Flange)	
	<input type="checkbox"/> -1102 (Round / Black Baffle / Satin Aluminum Flange)	
	<input type="checkbox"/> -1103 (Round / Bronze Baffle / Bronze Flange)	
	<input type="checkbox"/> -5100 ¹ (Round / White Baffle / Trimless)	
	<input type="checkbox"/> -5101 ¹ (Round / Satin Aluminum Baffle / Trimless)	
	<input type="checkbox"/> -5102 ¹ (Round / Bronze Baffle / Trimless)	
	<input type="checkbox"/> -5103 ¹ (Round / Black Baffle / Trimless)	
	<input type="checkbox"/> -2100 (Square / White Baffle / White Flange)	
	<input type="checkbox"/> -2101 (Square / Black Baffle / White Flange)	
	<input type="checkbox"/> -2102 (Square / Black Baffle / Satin Aluminum Flange)	
	<input type="checkbox"/> -2103 (Square / Bronze Baffle / Bronze Flange)	

1. Requires trimless mud plate, must specify

Dimensions

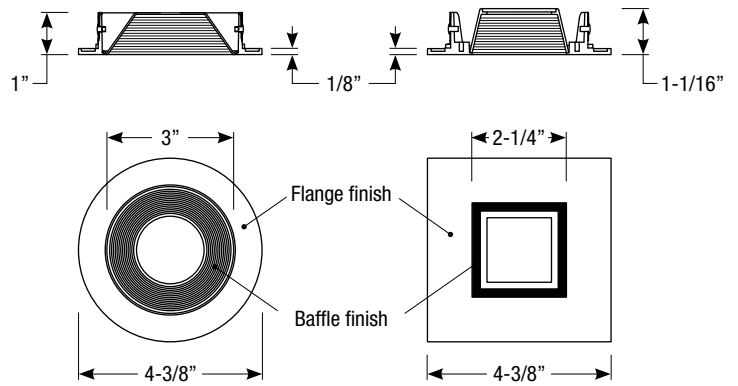

Note: Baffle downlight does not allow adjustable mechanism to tilt

Flush Mount Adapter

- EDL-RD-FMA (Round Flush Mount Adapter)
- EDL-SQ-FMA (Square Flush Mount Adapter)

Trimless Mud Plate

- EDL-RD-TR-4 (Round Trimless Mud Plate)

Trim Finishes

EDL-1100-4
White Baffle
White Flange



EDL-1101-4
Black Baffle
White Flange



EDL-1102-4
Black Baffle
Satin Aluminum Flange



EDL-1103-4
Bronze Baffle
Bronze Flange



EDL-5100-4
White Baffle

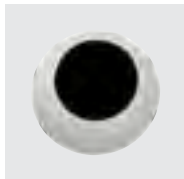

EDL-5101-4
Satin Aluminum Baffle

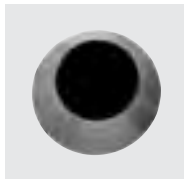

EDL-5102-4
Bronze Baffle

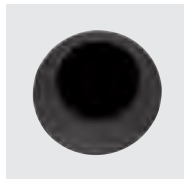

EDL-5103-4
Black Baffle

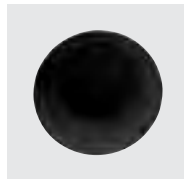

EDL-2100-4
White Baffle
White Flange

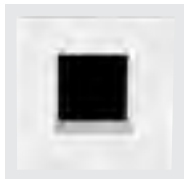

EDL-2101-4
Black Baffle
White Flange



EDL-2102-4
Black Baffle
Satin Aluminum Flange



EDL-2103-4
Bronze Baffle
Bronze Flange

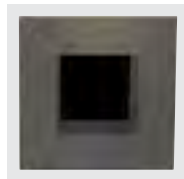

Revised 01/08/18

3" Eco-Downlight Shower / Adjustable Shower

IC Air-Tight Adjustable New Construction Housing

Round or Square

Catalog #:

Type:

Project:

Date:

Notes:

Shower Trim Order Matrix (Example: EDL-1201-4)

Series	Aperture / Finish	Rev
EDL	<input type="checkbox"/> -1200 (Round Shower Trim / White Flange)	-4
	<input type="checkbox"/> -1201 (Round Shower Trim / Satin Aluminum Flange)	
	<input type="checkbox"/> -2200 (Square Shower Trim / White Flange)	
	<input type="checkbox"/> -2201 (Square Shower Trim / Satin Aluminum Flange)	

Flush Mount Adapter

- EDL-RD-FMA (Round Flush Mount Adapter)
- EDL-SQ-FMA (Square Flush Mount Adapter)

EDL-1200-4
White Flange

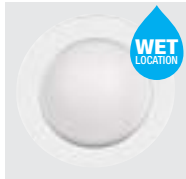

EDL-1201-4
Satin Aluminum Flange



EDL-2200-4
White Flange



EDL-2201-4
Satin Aluminum Flange



Dimensions

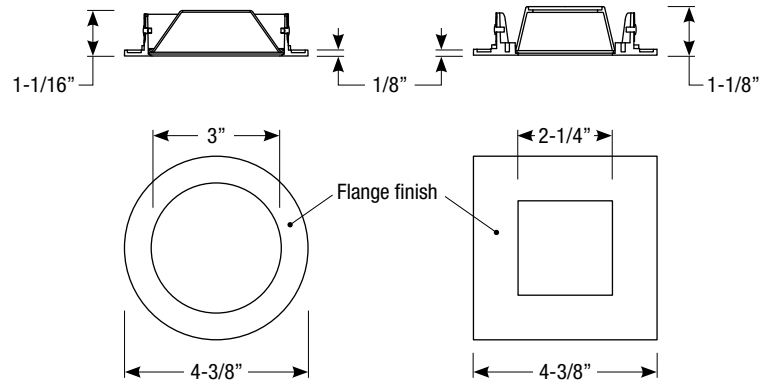

Note: Shower trim does not allow adjustable mechanism to tilt

Adjustable Shower Trim Order Matrix (Example: EDL-3000-4)

Series	Aperture / Finish	Rev
EDL	<input type="checkbox"/> -3000 (Round Shower Trim / White Flange)	-4
	<input type="checkbox"/> -3001 (Round Shower Trim / Satin Aluminum Flange)	
	<input type="checkbox"/> -3002 (Round Shower Trim / Bronze Flange)	
	<input type="checkbox"/> -4000 (Square Shower Trim / White Flange)	
	<input type="checkbox"/> -4001 (Square Shower Trim / Satin Aluminum Flange)	
	<input type="checkbox"/> -4002 (Square Shower Trim / Bronze Flange)	

Flush Mount Adapter

- EDL-RD-FMA (Round Flush Mount Adapter)
- EDL-SQ-FMA (Square Flush Mount Adapter)

EDL-3000-4
White Flange

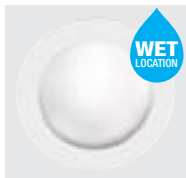

EDL-3001-4
Satin Aluminum Flange



EDL-3002-4
Bronze Flange

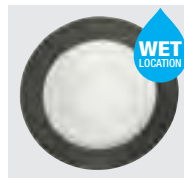

EDL-4000-4
White Flange



EDL-4001-4
Satin Aluminum Flange



EDL-4002-4
Bronze Flange



Dimensions

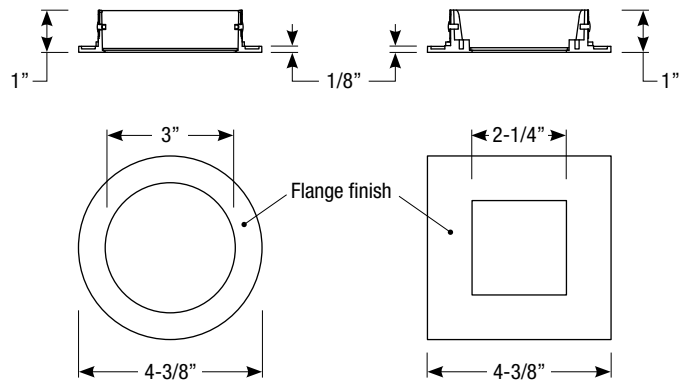

Note: Adjustable shower trim allows full adjustability

Revised 01/08/18

3" Eco-Downlight Wall Wash

IC Air-Tight Adjustable New Construction Housing

Round or Square

Catalog #:

Type:

Project:

Date:

Notes:

Wall Wash Order Matrix (Example: EDL-1702-4)

Series	Aperture / Finish	Rev
EDL	<input type="checkbox"/> -1700 (Round / Single Wall Wash / White Flange)	-4
	<input type="checkbox"/> -1701 (Round / Single Wall Wash / Satin Aluminum Flange)	
	<input type="checkbox"/> -1702 (Round / Single Wall Wash / Bronze Flange)	
	<input type="checkbox"/> -1800 (Round / Double Wall Wash / White Flange)	
	<input type="checkbox"/> -1801 (Round / Double Wall Wash / Satin Aluminum Flange)	
	<input type="checkbox"/> -1802 (Round / Double Wall Wash / Bronze Flange)	
	<input type="checkbox"/> -2300 (Square / Single Wall Wash / White Flange)	
	<input type="checkbox"/> -2301 (Square / Single Wall Wash / Satin Aluminum Flange)	
	<input type="checkbox"/> -2302 (Square / Single Wall Wash / Bronze Flange)	
	<input type="checkbox"/> -2400 (Square / Double Wall Wash / White Flange)	
	<input type="checkbox"/> -2401 (Square / Double Wall Wash / Satin Aluminum Flange)	
	<input type="checkbox"/> -2402 (Square / Double Wall Wash / Bronze Flange)	

Dimensions

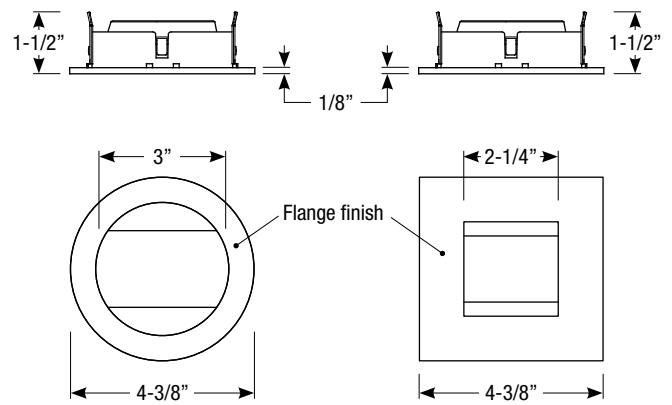

Flush Mount Adapter

- EDL-RD-FMA (Round Flush Mount Adapter)
- EDL-SQ-FMA (Square Flush Mount Adapter)

Trim Finishes

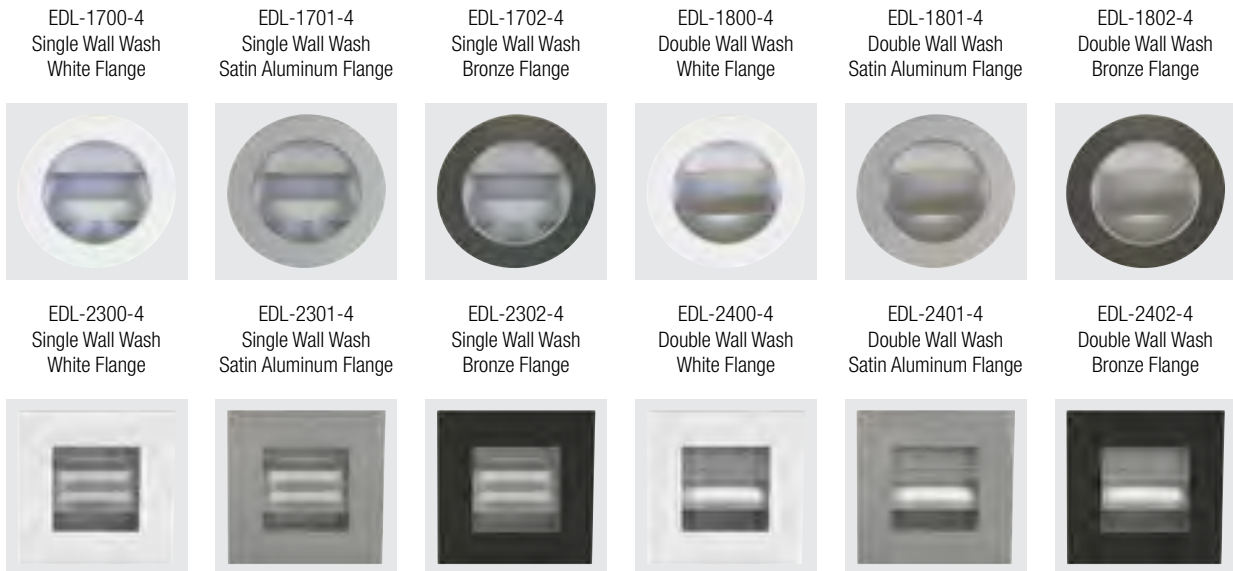

Revised 01/08/18

TYPE:	M1
CAT. #:	LSL6

LSL6 CYCLOPS



Down Light
DL-BR-BLP
(Actual Size)

Auroralight's new **LSL6** is a Micro-Directional X-Platform IP67 luminaire that features a Thermally Integrated™ and Field Serviceable LED module. The machined ball and socket design incorporates a remarkably small yet capable Cree® powered light engine. The easily replaceable, self-contained ball snugly into a precision machined socket for exceptional heat dissipation allowing this tiny luminaire to operate at 2 watts. Offered in 4 unique a multitude of and 4 interchangeable optics; it is both inconspicuous and versatile.

Features include:

- **2 Watts**
- Cree XLAMP® High Intensity (XP-L) LED
- 2700 or 3000K (CRI 80 typ.)
- Thermally Integrated™, Field Serviceable LED Module
- TRIAC Dimming to <10% typ.
- 12 VAC (Electronic or Magnetic Power Supply)
- Solid Copper and Brass Construction



Surface Mount
SM-BR-BLP

Male Thread
1/2-BR-BLP

Flush Mount
FM-BR-BLP

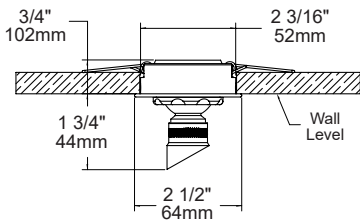

Down Light

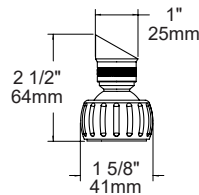

Surface Mount

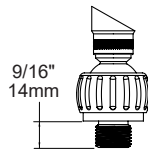

Male Thread

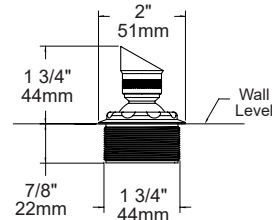

Flush Mount

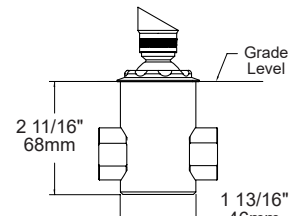

Flush Mount with optional Micro J-Box

ORDERING GUIDE LSL6: L (LED) SL (SPOTLIGHT) 6 X 1/8IN (SERIES)

RED INDICATES REQUIRED FIELD

CONFIGURATION	MATERIAL	SHROUD	OPTIC	LED	MOUNT (Category Options)	FINISH
[DL] Down Light	[BR] Brass	[60] 60° Angled	[N] 15° Narrow	[27D] 2700K	FM: FLUSH MOUNT OPTION	[NAT] Natural
[SM] Surface Mount	[CU] Copper*	[NS] No Shroud	[M] 25° Medium	[30D] 3000K	[MJB] Micro J-Box	[BLP] Bronze Living Patina
[1/2] Male Thread	*Shroud, ball and base remains Brass		[W] 40° Wide	[45D] 4500K	1/2: MALE THREAD MOUNTS	[PNI] Polished Nickel
[FM] Flush Mount			[EL] Elliptical	[D] = Dimmable	[G/S] Ground Stake	[BNI] Brushed Nickel
					[D/S-X] Deluxe Spike (9" or 12")	[PAU] PVD Gold
					[9x18] Telescopic Riser (Specify 5x10, 7x14, 9x18 or 11x22)	[BLK] PVD Black
					[T/S] Tree Strap	[PCR] PVD Chrome
					[CP4] 4" Cover Plate	
					[SM3] 3" Surface Mount	

[X] = Specify Length

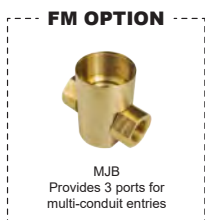

LSL6-FM L (LED) SL (SPOTLIGHT) 6 (SERIES) - FM (FLUSH MOUNT)

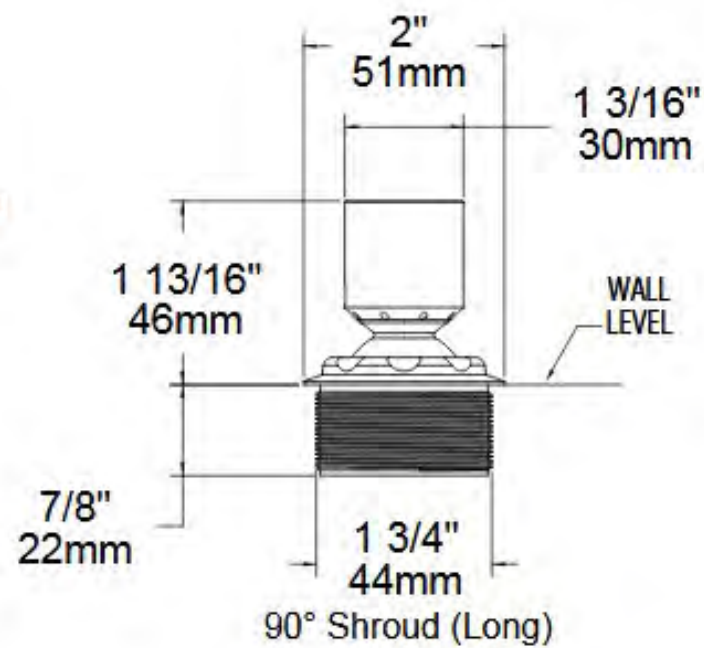
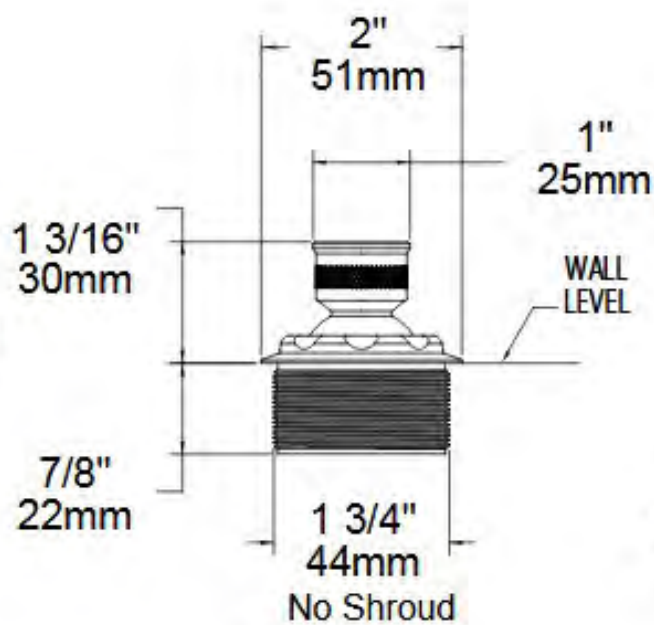
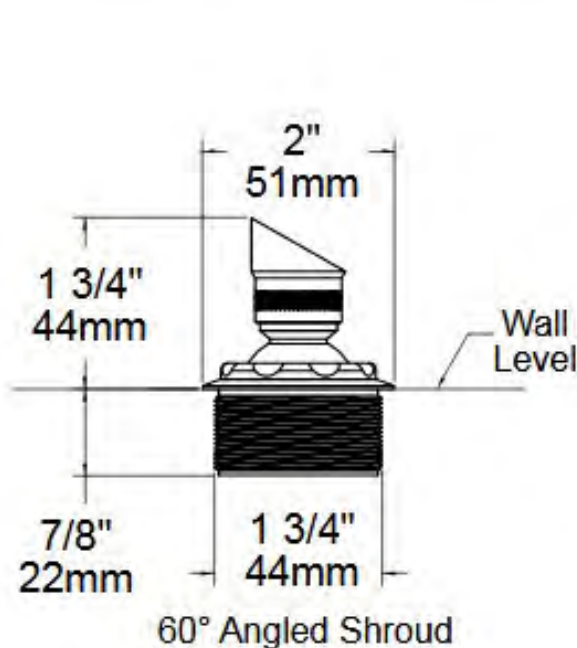
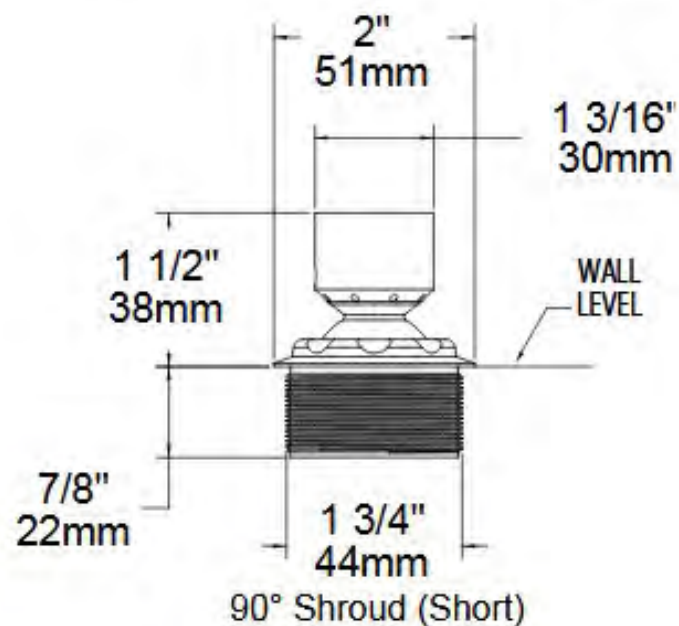
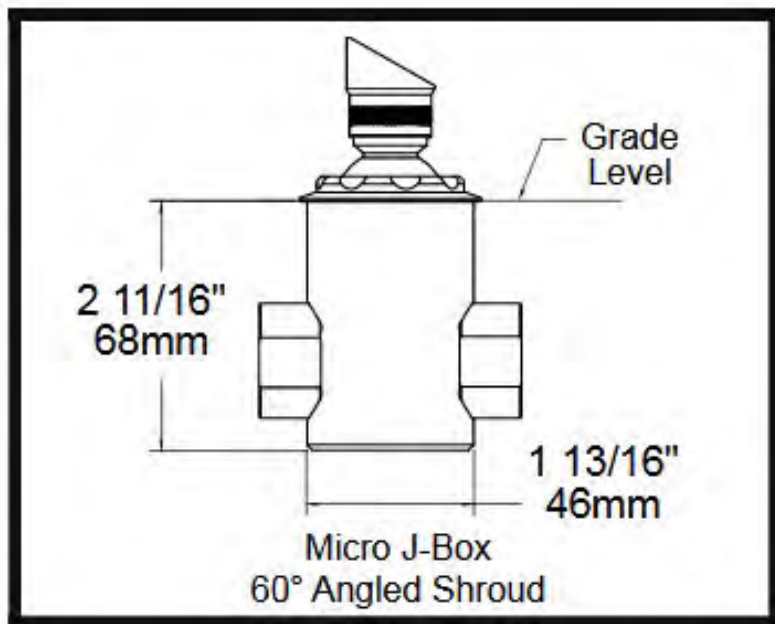

AR52

ADDRESS MARKER

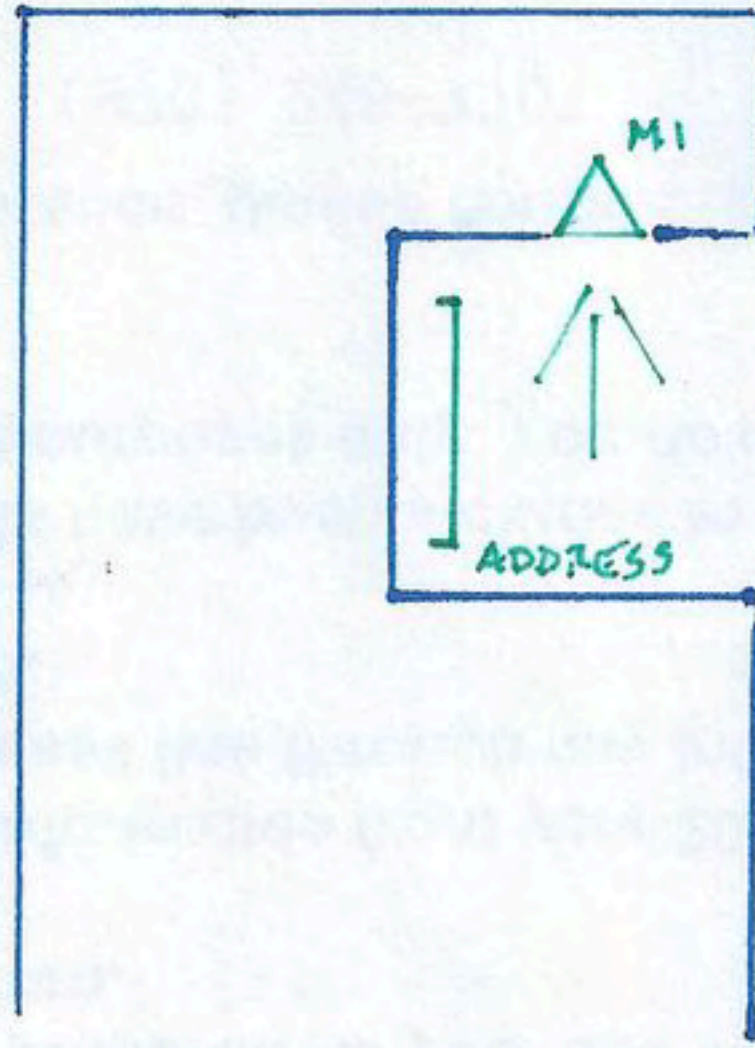

SIDE



BACK



JUNCTION BOX

FRONT

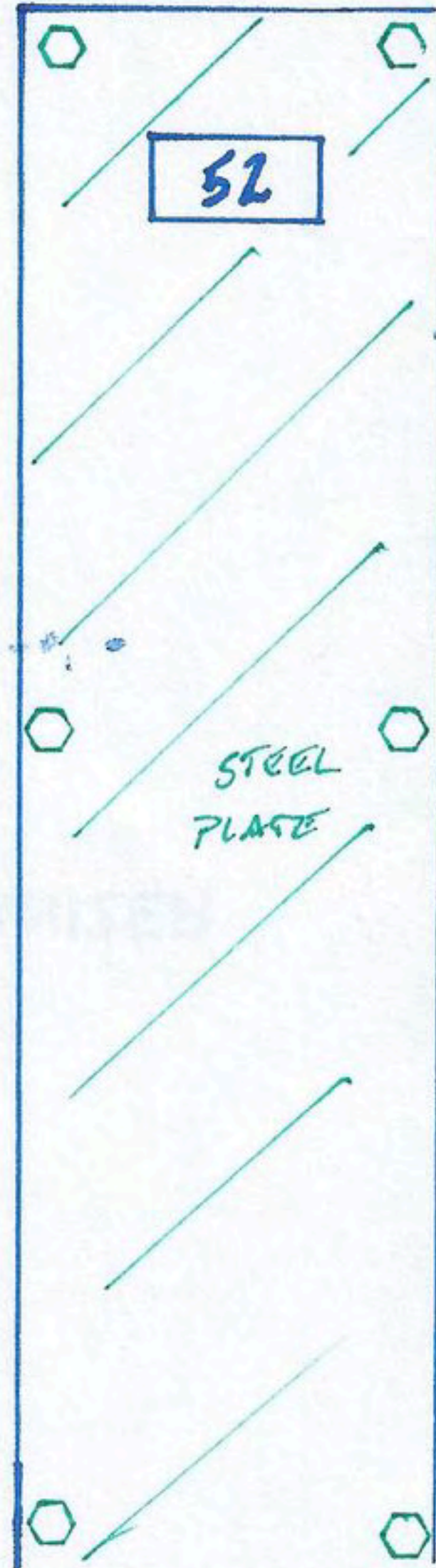

OPTION



NOT TO SCALE



DEVELOPMENT REFERRAL FORM

Planning & Development Services
Planning Division
455 Mountain Village Blvd. Ste. A
Mountain Village, CO 81435
(970) 728-1392

Referral Agency Comments

Lot AR-52R, 123 Adams

Way

Hi Amy,

No issues from Public Works. Have them field verify existing utilities.

Finn

Diversity of tree plantings clause is not met. – Mike Otto

Scott Heidergott – Fire Marshall

- 1) The structure is over 3,600 sq ft and shall require a monitored sprinkler system.
- 2) The width of the driveway shall meet the code of 16' total width. 12' shall be a hardP surface with the shoulders meeting the same compaction required as the hard surface and shall be an all weather driving surface.
- 3) The address monument shall be minimum 4'6" from grade to the bottom of the address numbers. Address numbers shall be 6" in height, reflective coated or outlined with a reflective coating.
- 4) TFPD recommends the installation of a Knox Box for access during emergency situations.



TO: Mountain Village Design Review Board

FROM: John Miller, Senior Planner

FOR: Design Review Board Public Hearing; June 10, 2021

DATE: May 26, 2021

RE: Staff Memo – Initial Architecture and Site Review, Lot 510, 131 Russell Dr.

Work Session Overview

PROJECT GEOGRAPHY

Legal Description: LOT 510 TELLURIDE MTN VILLAGE FILING 2 SF PLAT BK 1 PG 702 0.687 ACRES

Address: 131 Russel Drive
Applicant/Agent: Joe Kelleher, Kelleher Contracting
Owner: Samantha Moody
Zoning: Single-Family
Existing Use: Vacant
Proposed Use: Single-Family
Lot Size: 0.687 Acres

Adjacent Land Uses:

- **North:** Active OS
- **South:** Single-Family
- **East:** Single-Family
- **West:** Single-Family

ATTACHMENTS

- Exhibit A: Application
- Exhibit B: Plan Set
- Exhibit C: Public / Referral Comments



Figure 1: Vicinity Map

Case Summary: Joe Kelleher of Kelleher Contracting (Applicant), working on behalf of Samantha Moody (Owner), is requesting Design Review Board (DRB) approval of an Initial Architectural and Site Review (IASR) Application for a new single-family home on Lot 510, 131 Russell Drive. The Lot is approximately 0.0.687 acres and is zoned Single-Family. The overall square footage of the home is approximately 5,972 gross square feet and provides 3 interior parking spaces within the proposed garage and 1 exterior parking space in a tandem configuration.

The property is located between Lone Fir Lane and Double Eagle Drive on the north side of Russell Drive, and consists of a grass covered parcel containing a small area of existing slopes over 30%. In addition, the lot borders TSG open space along the Golf Course.

Applicable CDC Requirement Analysis: The applicable requirements cited may not be exhaustive or all-inclusive. The applicant is required to follow all requirements even if an applicable section of the CDC is not cited. ***Please note that Staff comments will be indicated by Italicized Text.***

Table 1

CDC Provision	Requirement	Proposed
Maximum Building Height	40' (gable) Maximum	35.37'
Maximum Avg. Building Height	35' (gable) Maximum	30.18'
Maximum Lot Coverage	40% Maximum	11.65%
General Easement Setbacks	16' GE	See GE Section Below
Roof Pitch		
Primary		7:12
Secondary		3:12, 4:12, 6:12
Exterior Material**		
Stone	35% minimum	35.03%
Windows/Doors	40% maximum	20.17%
Parking	2 enclosed / 2 surface	3/1

Design Review Board Specific Approvals:

1. *GE Encroachments*
2. *Tandem Parking / Parking Waiver*

Chapter 17.3: ZONING AND LAND USE REGULATIONS

17.3.12: Building Height Limits

Sections 17.3.11 and 17.3.12 of the CDC provide the methods for measuring Building Height and Average Building Height, along with providing the height allowances for specific types of buildings based on their architectural form. The proposed design incorporates Gabled roof forms which are granted a maximum building height of 40 feet. The maximum average height must be at or below 35 feet for gable roof forms. The average height is an average of measurements from a point halfway between the roof ridge and eave. The points are generally every 20 feet around the roof. The maximum height is measured from the highest point on a roof directly down to the existing grade or finished grade, whichever is more restrictive.

Staff: As part of this application, the applicant has provided both a Maximum Building Height and Average Building Height analysis. Based on the heights provided, the applicant is 35.37 feet from the highest ridge to the grade below on the gabled portion of the home.

Additionally, the applicant has provided a parallel plane analysis demonstrating that no portion of any roof penetrates the 40-foot parallel slope height allowance.

17.3.14: General Easement Setbacks

Lot 510 is burdened by a sixteen (16) foot General Easement (GE) which surrounds its perimeter. The CDC provides that the GE and other setbacks be maintained in a natural, undisturbed state to provide buffering to surrounding land uses. The CDC does provide for some development activity within the GE and setbacks such as Ski Access, Utilities, Address Monuments, and Fire Mitigation. All encroachments not listed above will require encroachment agreements between the property owner and the Town.

Staff: The proposal includes several GE encroachments that fall into the above category of permitted GE development activity including the following:

- *Driveway: The Driveway as shown currently takes access from Russell Drive and crosses the southern GE perpendicularly.*
- *Utilities: The shallow utilities connections are currently located within the Russell Drive ROW directly adjacent to the southern GE of Lot 510. The applicant has proposed connecting to those services and trenching them across the driveway to the home. The water is also located within Russell Drive and the applicant is proposing to connect to this service near the front of the home. It appears based on the civil drawings that the western and northern GE will also need to be disturbed to accommodate the gas line and sanitary sewer.*

Staff: There are additional encroachments into the GE as shown within this proposal. These will require the DRB make a determination that this is appropriate. If not, then the applicant shall revise the plans to remove non-permitted GE encroachments.

- *Grading: Due to the topography of the site and necessary retainage for the parking areas, the applicant has proposed a retaining wall to be located outside of the GE but this wall will necessitate excavation and layback to occur within the southern and western GE. Alternatively, the applicant has also designed and provided a taller retaining wall that does not require utilization of the GE other than for construction but feels that the shorter wall with grading reduces the massing of the retaining wall and is preferable.*

Chapter 17.5: DESIGN REGULATIONS

17.5.4: Town Design Theme

The Town of Mountain Village has established design themes aimed at creating a strong image and sense of place for the community. Due to the fragile high alpine environment, architecture and landscaping shall be respectful and responsive to the tradition of alpine design – reflecting elements of alpine regions while blending influences that visually tie the town to mountain buildings. The town recognizes that architecture will continue to evolve and create a regionally unique mountain vernacular, but these evolutions must continue to embrace nature and traditional style in a way that respects the design context of the neighborhoods surrounding the site.

Staff: The home appears to blend well into the existing design theme of the Mountain Village given its strong material palette of stone, timbers, cedar siding, and metal accents. With that, there are certain aspects of the home that staff wants to discuss as part of this memo in order to understand the DRB's level of comfort.

- *Exposed Concrete – The applicant has provided 3-D renderings of the home on pages A4.1-A4.7 which show exposed concrete in different locations on the home. The renderings appear to show concrete on an exposed above grade foundation element, along with the exposed footers for the deck, and the chimney cap ring. Concrete is not an allowable exterior material and staff recommends revising this detail so that no exposed concrete is visible prior to submittal for final review. Boardform concrete is allowable with specific DRB approval but the applicant has not indicated that this exposed concrete is to be boardform.*

It appears based on the applicant's submittal that the material palette for the project blends well with both the surrounding community, as well as the overall modern mountain vernacular, but the DRB must determine if the above items are appropriate. If they are not, the then applicant should revise accordingly.

17.5.5: Building Siting Design

The CDC requires that any proposed development blend into the existing landforms and vegetation.

Staff: Given the topographical site constraints for Lot 510, staff believes that the applicant has logically sited the home. Because of the elevation change between the Lot and Russell Drive, the home has been built somewhat into the hillside which helps it to be more subdued on the lot as seen from Russell Drive. According to the Town Wetland maps, this site does not contain delineated wetlands but it should be noted that there does appear to be an ephemeral spring or drainage located on the northeast portion of the lot as identified in the image below.



It will be very important as we move towards Final Review to better understand this ephemeral drainage and understand if its under the jurisdiction of the Army Corps of Engineers (USACE). With that, staff is recommending the DRB place a condition of any final approval requiring a wetland delineation and jurisdictional determination from the USACE.

Given these constraints, staff does find that the proposed home has been sited correctly on the lot and overall it blends into the existing landforms and vegetation.

17.5.6: Building Design

Staff: The CDC requires that building form and exterior wall forms portray a mass that is thick and strong with a heavy grounded foundation. In order to accomplish this, the applicant is proposing a light colored "sage ledgestone" in a random rectangular arrangement. Its unclear to staff if the stone is proposed to be drystacked or grouted and this information should be provided prior to final review. The proposed wood siding is a mixture of 6' vertical and horizontal cedar stained siding but staff is also requesting that additional information such as wood type and dimensions for the materials be provided prior to final review. A prominent element of the home is the exposed timber frame utilized on most elevations which accent the front and rear elevations framing the fenestration of the home. These timbers are carried throughout the other elevations of the home on the porches and underneath the roof eaves. The fascia and soffits are proposed as douglas fir tongue and groove.

Overall, the contrast of the wood and arrangement of the stone appears to complement the design. Based on the plans provided, the applicant is meeting all materials requirements for Stone and Glazing.

Window and door trim are proposed as steel matte black product, but more detail should be provided related to the recess details for the windows, doors, and garage door, as the CDC requires any door or window set in stone be recessed a specific depth. Its unclear to staff based on the material sheet of the packet if the proposed roofing material is a standing seam product, but assuming that it is a matte black standing seam is permissible by the CDC. Any roof areas directly above pedestrian walkways must provide snow retention devices – which has been noted on the plans but staff does request additional design and location information. Staff would note that the proposed chimney cap is pre-cast concrete and staff recommends this be modified or constructed on-site with board form concrete. The DRB should discuss these items and the applicant should revise accordingly prior to final review.

The applicant has not proposed any snowmelt floor area at this time but does show a heated V-pan on the civil drawings. It is anticipated that this home will have additional exterior snowmelt. Prior to final review, the applicant shall revise these plans to detail all areas of exterior snowmelt and the associated square footages, as applicable.

17.5.7: Grading and Drainage Design

Staff: The applicant has provided a grading and drainage plan in accordance with the CDC requirements. Due to the size of the lot, the majority of the lot is shown as requiring grading but it does appear that the grading to the rear and more sensitive area of the lot has been limited. Based on the outcome of any required wetland delineation, the grading plans may be required to be revised slightly to limit disturbance in any wetland areas. Otherwise, the grading and drainage plan demonstrates positive drainage away from the home. It may be helpful to better understand the limits of disturbance for the construction of the retaining wall, along with the plan for material export based on excavation requirements during construction given the limited size of the Lot and limited ability to store excavated materials.

The majority of the grading occurs to the south of the home as required to create access and provide retainage for the autocourt. Within the civil plans, the applicant has provided two scenarios for DRB feedback. The first of which allows for the development of a taller retaining wall that does not encroach onto the GE, and the second option allows for a smaller wall with grading within the GE. The applicant prefers to have a smaller wall so

that the mass and bulk of the wall is reduced. The DRB should discuss these scenarios and determine their preference.

17.5.8: Parking Regulations

Staff: The CDC requires all single-family developments provide two interior and two surface parking spaces. The applicant has shown a total of 3 interior spaces and 1 surface space, and is requesting the DRB waive the additional 1 surface parking space and granting tandem parking. Staff will note that the location of the surface tandem parking space may need to be reconsidered given the location of the retaining wall and the turn radius to maneuver out of the parking area.

DRB should discuss possibly granting approval for tandem parking but it may be more logical to discuss waiving the requirement for surface parking as permitted by the CDC. These provisions are intended and allowed for smaller lots less than 0.75 acres with unique site conditions such as steep slopes and unique shaped lots. Staff is not opposed to this option, but it should be discussed in more detail at the public hearing.

17.5.9: Landscaping Regulations

The applicant has provided a conceptual landscaping plan to for initial review. This plan demonstrates planting and irrigation locations, revegetation notes, and other general requirements. It should be noted that no landscaping is located within the GE. Prior to final review, the plan shall be revised to include details on the exterior rear patio paver materials, additional variation in the diversity of tree and shrub plantings, as well as revised to remove conifer species located within 15 feet of the dripline of the home. See additional discussion within the Wildfire and Forestry Provisions below.

17.5.11: Utilities

Staff: All utilities except for sanitary sewer are currently located within the ROW and will only require connections from the road to the home. The sewer is located to the north of the home and will require that the applicant tie into the sewer line on TSG open space. This will require the proper private agreements prior to construction. The applicant shall work with the Public Works Director before the final review to determine the specific locations of the connections for the home as these locations are conceptual only.

17.5.12: Lighting Regulations

Staff: The applicant has provided a preliminary lighting plan at this time and staff will note general compliance with the requirements of the CDC for all of the proposed fixtures with the exception of fixtures L2 and L3 which exceed lumen requirements. The applicant has proposed limiting the output of these fixtures to 85% so that they meet the lumen output requirements. Additionally, it appears that the rear porch has a number of these recessed ceiling fixtures, which may over illuminate this area as seen from Double Eagle Dr. The DRB should discuss overall light output on this rear porch and determine if it is excessive. Staff is recommending that the lighting in this area of the home be reduced.

17.5.13: Sign Regulations

Staff: The applicant has provided details on the address monument and the monument appears to meet all requirements of the CDC. The design of the monument matches the materials of the home but staff does somewhat questions the longevity of the materials over time as it appears to be primarily constructed of wood which could present issues given the snow accumulation from snow removal operations on Russell Drive. The location of the monument is located within Town road ROW, and prior to the issuance of a certificate of occupancy, the applicant will be required to enter into a non-revocable ROW encroachment agreement as a condition of approval.

Chapter 17.6: SUPPLEMENTARY REGULATIONS

17.6.1: Environmental Regulations

Staff: Fire Mitigation and Forestry Management: The site is largely devoid of any vegetation with the exception of grasses, and some small diameter trees located within the GE and shown on the tree survey. Staff does recognize the need for screening given the close proximity of existing homes on either side of the lot and recommends that the applicant provide a specific fire mitigation plan that includes any required screening within the dripline of the home. This allows for the site to be screened but meets the wildfire provisions as well. Prior to final review, the applicant shall address the fire mitigation requirements with the Town Forester as a condition of IASR approval.

Wetland Regulation: Any development application for a Lot that contains wetlands or is in close proximity of wetlands on adjoining lots shall, as part of the development application submit a wetland delineation performed by an UASCE qualified consultant. This should be required by the DRB as part of any final condition of approval.

Steep Slopes: The building site does contain limited steep slopes and it should be noted that these areas will be disturbed as part of this proposed development. Given the small size of the lot as the sensitive areas to the rear of the home, staff does not object to the limited disturbance of these areas.

17.6.6: Roads and Driveway Standards

Staff: The driveway as shown meets the CDC standards with 12 feet width and 2-foot shoulders on each side. The maximum grade of the driveway appears to be approximately -7.9%. The civil drawings demonstrate approximately 43.5 feet of back up space within the autocourt.

17.6.8: Solid Fuel Burning Device Regulations

Staff: The applicant has indicated that the proposed home does include fireplaces and unless the owners procure a fireplace permit, these must operate on natural gas. Prior to Final Review, these plans should be revised to explicitly state that they are natural gas burning fireplaces unless the permit is otherwise acquired.

Chapter 17.7: BUILDING REGULATIONS

17.7.19: Construction Mitigation

Staff: The applicant has submitted a construction mitigation plan for this project and staff has the following comments as it relates to the CMP:

- 1. The temporary office shown on Russel Dr. ROW must be located entirely within Lot 510's boundary.*
- 2. Construction fencing should be adjusted to limit impacts within the GE where possible. Where not possible to limit these impacts, the GE must be revegetated and returned to its pre-existing condition. Based on any wetland delineation, the fencing and erosion control may be required to be adjusted.*
- 3. Although not required, staff would note the crane radius and the proximity to existing homes. Staff suggests working with these neighbors to ensure any issues are addressed.*

Staff Recommendation: Staff recommends the DRB approve the Initial Architectural and Site Review for Lot 510, 131 Russell Dr.

Staff Note: It should be noted that reasons for approval or rejection should be stated in the findings of fact and motion.

Proposed Motion:

If the DRB deems this application to be appropriate for approval, Staff requests said approval condition the items listed below in the suggested motion.

I move to approve the Initial Architectural and Site Review for a new single-family home located at Lot 510, 131 Russell Drive, based on the evidence provided within the Staff Report of record dated May 26, 2021, with the following and Specific Approvals:

Design Review Board Specific Approvals:

1. *GE Encroachments*
2. *Tandem Parking / Parking Waiver*

And, with the following conditions:

- 1) Prior to submittal for a Final Architectural Review, the applicant shall revise the exterior elevations to remove all exposed concrete such as the foundation elements and the deck footers. These concrete elements must be faced or receive DRB specific approval for board form.
- 2) Prior to submittal for a Final Architectural Review, the applicant shall revise the landscaping plan and the Wildfire Mitigation per the comments from this memo of record and submit to the Town Forester for review.
- 3) Prior to submittal for a Final Architectural Review, the applicant shall demonstrate all areas of exterior snowmelt.
- 4) Prior to the submittal for a Final Architectural Review, the applicant shall provide additional details related to the proposed stone, wood siding, and rear patio paver stones.
- 5) Prior to the issuance of a building permit, the applicant shall field verify all utilities and submit a revised utility plan to the public works director identifying the location of utilities and connection points.
- 6) Consistent with town building codes, Unenclosed accessory structures attached to buildings with habitable spaces and projections, such as decks, shall be constructed as either non-combustible, heavy timber or exterior grade ignition resistant materials such as those listed as WUIC (Wildland Urban Interface Code) approved products.
- 7) Prior to issuance of a CO, the property owner will enter into a General Easement Encroachment Agreement and Road Right of Way Encroachment Agreement, as applicable, with the Town of Mountain Village for any encroachments approved.
- 8) A monumented land survey shall be prepared by a Colorado public land surveyor to establish the maximum building height and the maximum average building height.
- 9) A monumented land survey of the footers will be provided prior to pouring concrete to determine there are no additional encroachments into the GE.
- 10) Prior to the Building Division conducting the required framing inspection, a four-foot (4') by eight-foot (8') materials board will be erected on site consistent with the review authority approval to show:
 - a. The stone, setting pattern and any grouting with the minimum size of four feet (4') by four feet (4');
 - b. Wood that is stained in the approved color(s);
 - c. Any approved metal exterior material;
 - d. Roofing material(s); and
 - e. Any other approved exterior materials

/jjm



May 20, 2021

Item #7: Development Narrative

Kelleher Contracting, LLC has been hired by Samantha Moody to build a single-family residence on lot 510, 131 Russell Drive, in Mountain Village. The home is a two-story timber frame structure with a walk out basement.

We are requesting that the Design Review Board put us on the June 10th Review Board Meeting Schedule for our first review of the project.

The design is compliant with the applicable criteria for decision as follows:

1. The proposed house meets the design regulations for a single family home including height restriction, exterior finishes and site lighting requirements.
2. The proposed house is in compliance with the zoning and use regulations.
3. The proposed house complies with the road and driveway standards.
4. The proposed house is in compliance with all other applicable CDC regulations with two variances requested in section 12.



May 25, 2021

Item #12: Design Variations

Due to the steep grade and elevation change from the Southwest corner of the lot to the building pad we are asking for design variations and DRB specific approvals for the following items:

1. The driveway design is at 8% to get to the motor court limiting the area available to create parking. We have a three-car garage and would like create a tandem parking condition in the motor court to comply with the parking requirements in section 17.5.8.A.2. Our lot is below .75 acres.
2. The Southwest corner of the garage is not encroaching on the General Easement but due to the steep slope of that portion of the lot we will need to retain the slope. Our options are to build a 6' retaining wall that does not encroach on the GE, build a 4' wall with a 4' gap to a 2' wall that would be in the GE or to build a smaller retaining wall and then grade the existing grade in the GE to meet a reduced wall that would comply with the intent of 17.6.6.6.a while not exceeding the 2:1 slope maximum from 17.5.7.F. In our DRB Design Drawings we chose to reflect a 2' retaining wall with a change of grade in the GE. We chose this option to create a more natural sloping condition and softer appearance with the reduced wall height. This design variation does not have an unreasonable negative impact on lot 509 or other areas in the neighborhood. The wall itself is under the 5' maximum height requirement.



Wire Backed Silt Fence

SF-90 w 36" 2x4 14ga welded wire

Silt Fence Fabric is a preassembled silt fence with 36" TerraTex SF-90 woven geotextile attached to 36" 14 gauge 2x4 welded wire. The TerraTex SF-90 is made up of polypropylene filaments. These filaments are woven to form a stable and durable network such that the filaments retain their relative position. It is non-biodegradable and resistant to most soil chemicals, acids, and alkali with a pH range of 3 to 12. TerraTex SF-90 is manufactured to meet or exceed the following minimum average roll values:

<u>Property</u>	<u>Test Method</u>	<u>Minimum Average Roll Value English</u>	<u>Minimum Average Roll Value Metric</u>
Grab Tensile	ASTM D-4632	100 x 100 lb	0.445 x 0.445 kN
Elongation	ASTM D-4632	15% x 20%	15% x 20%
Mullen Burst	ASTM D-3786	250 psi	1723 kPa
Puncture	ASTM D-4833	50 lb	0.223 kN
Trap Tear	ASTM D-4533	50 lb	0.223 kN
UV Resistance	ASTM D-4355	80% @ 500 hr	80% @ 500 hr
AOS	ASTM D-4751	20 - 50 US Sieve	0.85 - 0.300 mm
Permittivity	ASTM D-4491	0.10 sec-1	0.10 sec-1
Flow Rate	ASTM D-4491	8 gal/min/ft ²	325.6 l/min/m ²

11/2009



9" Straw Wattles/Straw Logs/Restoration Logs

Used as a sediment filter barrier on slopes and erosion-prone areas. When installed, they reduce surface sheet flow erosion and capture sediment

SPECIFICATIONS

LENGTH:	25' STANDARD (OTHER LENGTHS CAN BE SPECIAL ORDERED)
DIAMETER:	9" (+/- 10%)
CORE:	AGRICULTURE, CERTIFIED NOXIOUS WEED FREE STRAW
NETTING TYPE:	UV STABILIZED/PHOTODEGRADABLE
NETTING WEIGHT:	HEAVY DUTY: 94% HIGH-DENSITY POLYETHYLENE WITH 6% UV INHIBITOR
NETTING THICKNESS:	STRAND THICKNESS OF 0.03", KNOT THICKNESS OF 0.055"
NETTING WEIGHT:	0.35-OUNCE PER FOOT (+/- 10%)
NETTING COLOR:	BLACK (OTHER COLORS CAN BE SPECIAL ORDERED)
ROLL WEIGHT:	AVERAGE 35 LBS. (+/- 10%)
WEIGHT PER LF:	NO LESS THAN 1.4 LBS (+/- 10%)

Our Sediment Control Products are used in a multitude of applications, providing benefits such as:

- Better filtering of runoff waters
- Preventing check dam blowouts
- Protecting water from going around check dams
- Preventing the spread of non-native vegetation
- Ease of use: Easier to handle and install than straw bales

DISTRIBUTED BY:
TRITON ENVIROMENTAL
5433 NEWPORT STREET
COMMERCE CITY, CO 80022
O: 303.945.7588 F: 303.945.7579

Lot 510 Computer Massing Model

<https://a360.co/3u0TVFH>



TELLURIDE FIRE PROTECTION DISTRICT

Scott Heidergott, Fire Marshal

Address: 129 Adams Way
Mountain Village, CO 81435

Architect: Architects Collaborative

- 1) The width of the driveway shall meet the code of 16' total width. 12' shall be a hard surface with the shoulders meeting the same compaction required as the hard surface and shall be an all-weather driving surface.
- 2) The address monument shall be minimum 4'6" from grade to the bottom of the address numbers. Address numbers shall be 6" in height, reflective coated or outlined with a reflective coating.
- 3) TFPD recommends the installation of a Knox Box for access during emergency situations.

NorthEastern View

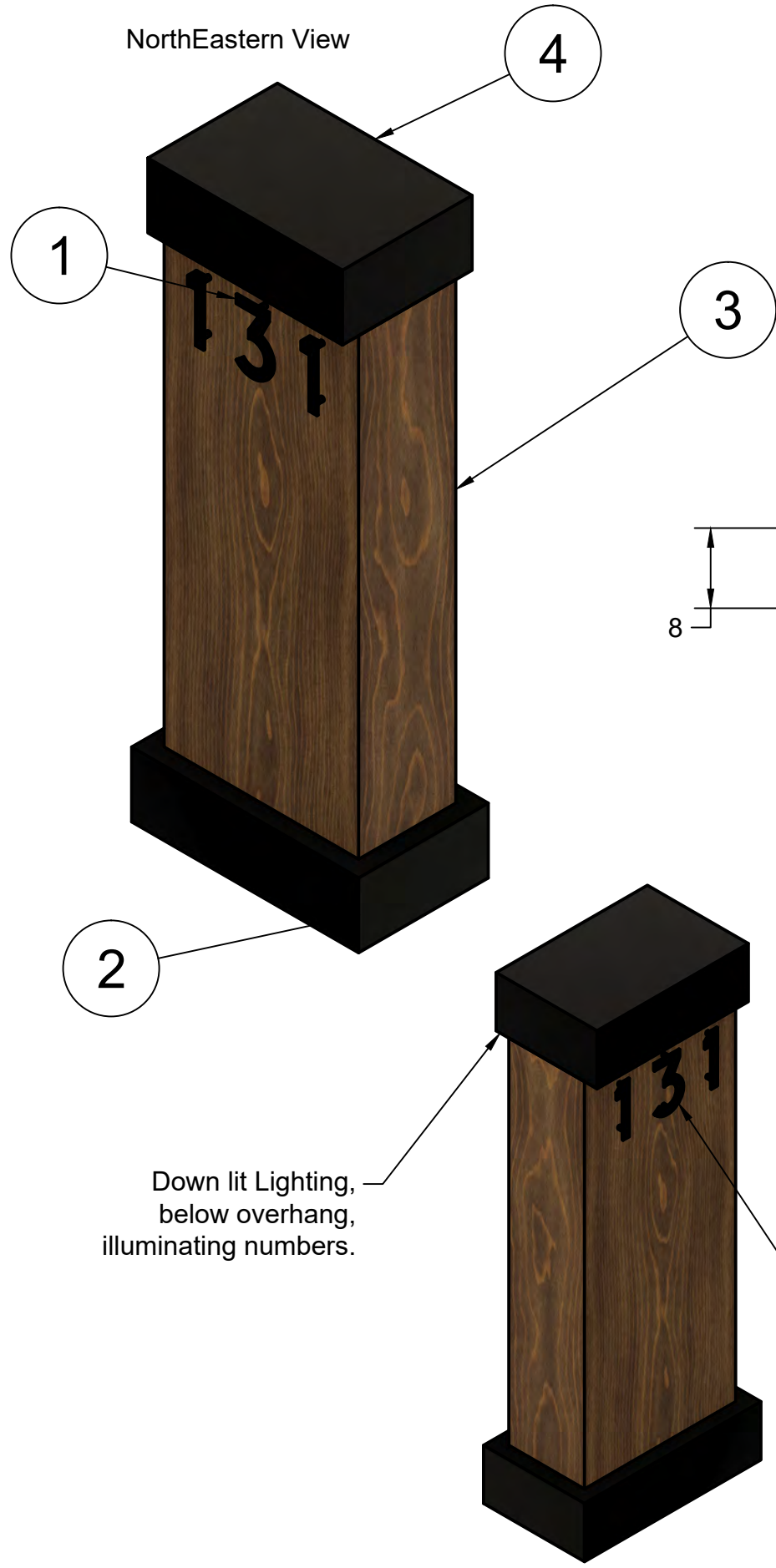

PARTS LIST			
ITEM	PART NUMBER	DESCRIPTION	MATERIAL
1	1/8" METAL #'S	CUT OUT METAL NUMBERS	STEEL
2	CAPPED METAL BASE	THIN METAL SHEETING CAPPING CONCRETE FORM	STEEL
3	WOOD SIDING	WOOD SIDING SAME AS HOUSE	DOUGLAS FIR
4	CAPPED METAL TOP	THIN METAL SHEETING	STEEL

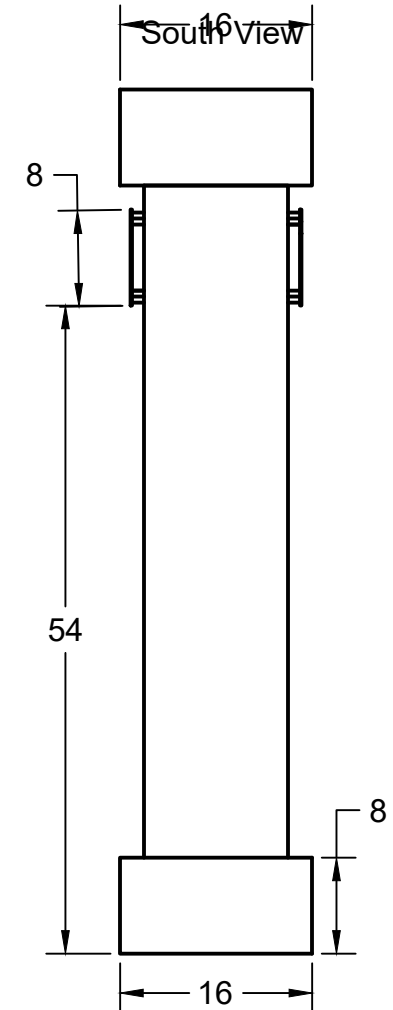
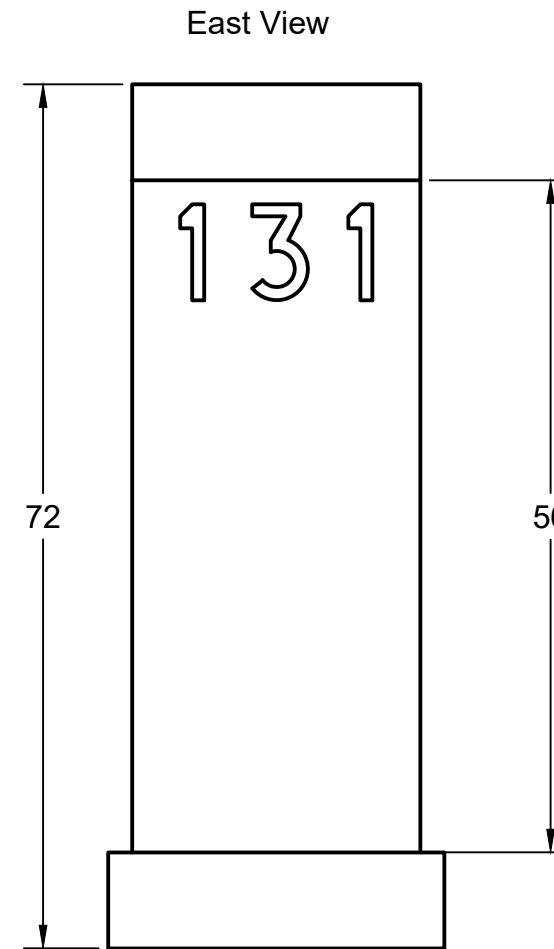
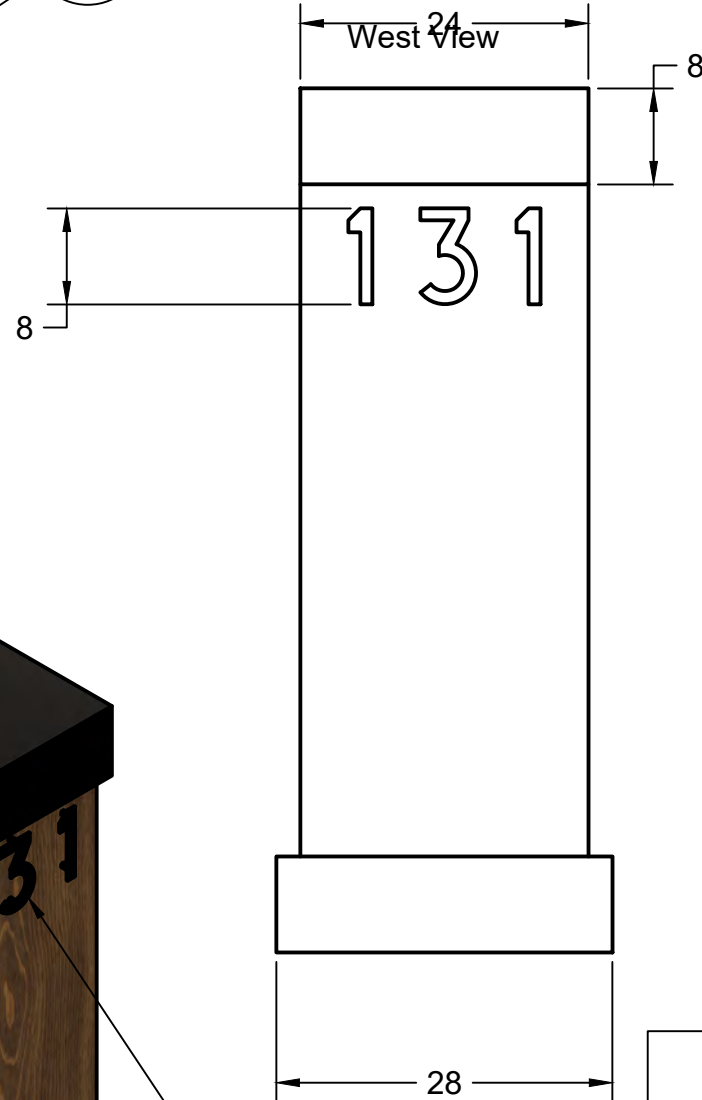

Down lit Lighting,
below overhang,
illuminating numbers.

Reflective coating added.

PROJECT		Colorado House number		
TITLE		House Number 131 Russel Drive, Mountain Village, CO 81435		
APPROVED	SIZE	CODE	DWG NO	REV
CHECKED	B			
DRAWN	Marcus Engel	4/14/2021	SCALE 1:16	WEIGHT
			SHEET 1/1	



MOODY RESIDENCE

P.O. BOX 1665
GOLDEN, BRITISH COLUMBIA, CANADA
V0A 1H0

OFFICE: (250) 348-2231
FAX: (250) 348-2241
WEB: WWW.CANADIANTIMBERFRAMES.COM

DRAWN BY: MM
20130
2021-05-25 12:15:34 PM

THESE DRAWINGS ARE THE PROPERTY OF CANADIAN TIMBERFRAMES LTD. AND MAY NOT BE REPRODUCED OR COPIED WITHOUT OUR WRITTEN CONSENT. ALL DESIGNS, IDEAS, AND CONCEPTS DEVELOPED IN THIS DRAWING SHALL REMAIN AT ALL TIMES THE SOLE PROPERTY OF CANADIAN TIMBERFRAMES LTD.

A-0.1
ISSUED FOR: DRB REVIEW

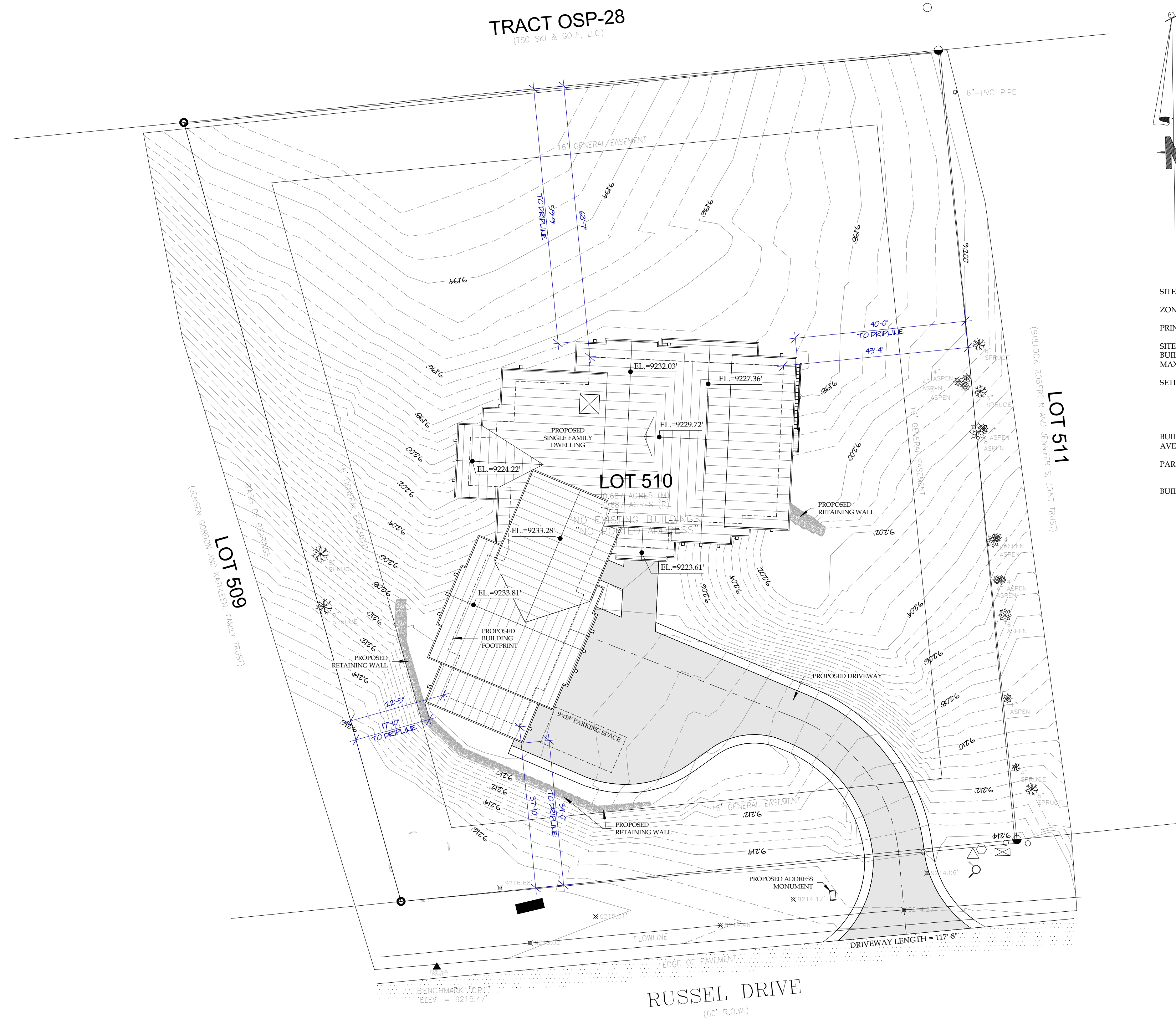

SITE INFORMATION

ZONE DISTRICT: SINGLE FAMILY
 PRINCIPAL USE: SINGLE FAMILY DWELLING

SITE AREA: 0.687 ACRES
 BUILDING AREA: 3487.49 S.F.
 MAXIMUM LOT COVERAGE: 40% PROPOSED: 11.65%

SETBACKS:

MINIMUM FRONT YARD:	16'	PROPOSED:	37'-10"
MINIMUM REAR YARD:	16'	PROPOSED:	63'-7"
MINIMUM SIDE YARD:	16'	PROPOSED:	WEST SIDE: 22'-5" EAST SIDE: 43'-4"

BUILDING HEIGHT:

MAXIMUM:	35'+5" (40')	PROPOSED:	35.37'
AVERAGE BUILDING HEIGHT:	MAXIMUM: 30'	PROPOSED:	30.18'

PARKING:

REQUIRED: 2 ENCLOSED SPACES & 2 SURFACE PARKING SPACES
 PROVIDED: 3 ENCLOSED SPACES & 1 SURFACE PARKING SPACE

BUILDING GFA

BASEMENT:	2344 S.F.
MAIN FLOOR:	2163 S.F.
LOT OVER GARAGE:	420 S.F.
HOUSE TOTAL:	5127 S.F.
GARAGE:	845 S.F.
HOUSE w/GARAGE:	5972 S.F.

① SITE PLAN-PROPOSED GRADE
 1" = 16'-0"



PROPOSED SITE PLAN

P.O. BOX 1665
 GOLDEN, BRITISH COLUMBIA, CANADA
 V0A 1H0

OFFICE: (250) 348-2231
 FAX: (250) 348-2241
 WEB: WWW.CANADIANTIMBERFRAMES.COM

MOODY RESIDENCE
 20130
 2021-05-25 12:15:40 PM

ISSUED FOR: DRB REVIEW

THESE DRAWINGS ARE THE PROPERTY OF CANADIAN TIMBERFRAMES LTD. AND MAY NOT BE REPRODUCED OR COPIED WITHOUT OUR WRITTEN CONSENT. ALL DESIGNS, IDEAS, AND CONCEPTS DEVELOPED IN THIS DRAWING SHALL REMAIN AT ALL TIMES THE SOLE PROPERTY OF CANADIAN TIMBERFRAMES LTD.

A-1.1

GENERAL CIVIL ENGINEERING NOTES:

1. THE EXISTING UTILITY LINES SHOWN ON THE PLANS ARE APPROXIMATE. AT LEAST TWO (2) FULL WORKING DAYS PRIOR TO COMMENCING CONSTRUCTION, THE CONTRACTOR SHALL CONTACT THE UTILITY NOTIFICATION CENTER OF COLORADO @ 1-800-922-1987 OR 811 TO GET ALL UTILITIES LOCATED. IF ANY OF THESE UNDERGROUND UTILITIES ARE IN CONFLICT WITH THE CONSTRUCTION PLANS, THE CONTRACTOR SHALL NOTIFY THE ENGINEER AND WORK WITH THE ENGINEER TO FIND A SOLUTION BEFORE THE START OF CONSTRUCTION.

INSTALLATION AND SEPARATION REQUIREMENTS SHALL BE COORDINATED WITH THE INDIVIDUAL UTILITY PROVIDERS.

THE UTILITY PROVIDERS ARE:
SEWER, WATER, CABLE TV AND FIBEROPTIC: TOWN OF MOUNTAIN VILLAGE
NATURAL GAS: BLACK HILLS ENERGY
POWER: SAN MIGUEL POWER
TELEPHONE: CENTURY LINK

2. PRIOR TO BEGINNING ANY CONSTRUCTION ACTIVITIES, ALL NECESSARY PERMITS SHALL BE OBTAINED BY THE OWNER OR CONTRACTOR.

3. IT IS THE CONTRACTOR'S RESPONSIBILITY TO INSURE THAT EXCAVATED SLOPES ARE SAFE AND COMPLY WITH OSHA REQUIREMENTS. REFER TO THE SITE-SPECIFIC REPORT FOR THIS PROJECT FOR ADDITIONAL INFORMATION..

4. ALL TRENCHES SHALL BE ADEQUATELY SUPPORTED OR LAID BACK PER OSHA REGULATIONS.

5. ALL MATERIALS AND CONSTRUCTION SHALL BE IN CONFORMANCE WITH THE TOWN OF MOUNTAIN VILLAGE DESIGN STANDARDS LATEST EDITION. ALL CONSTRUCTION WITHIN EXISTING STREET OR ALLEY RIGHT-OF-WAY SHALL BE SUBJECT TO TOWN OF MOUNTAIN VILLAGE INSPECTION.

6. THE CONTRACTOR SHALL HAVE ONE COPY OF THE STAMPED PLANS ON THE JOB SITE AT ALL TIMES.

7. THE CONTRACTOR SHALL NOTIFY THE TOWN 48 HOURS PRIOR TO THE START OF CONSTRUCTION.

8. THE CONTRACTOR IS RESPONSIBLE FOR IMPLEMENTING AND MAINTAINING EROSION AND SEDIMENT CONTROL MEASURES AT ALL TIMES DURING CONSTRUCTION. THE ADJOINING ROADWAYS SHALL BE FREE OF DEBRIS AT THE END OF CONSTRUCTION ACTIVITIES EACH DAY.

9. THE CONTRACTOR SHALL PROVIDE, ERECT AND MAINTAIN PROPER TRAFFIC CONTROL DEVICES UNTIL THE SITE IS OPEN TO TRAFFIC. ANY TRAFFIC CLOSURES MUST BE COORDINATED WITH THE TOWN OF MOUNTAIN VILLAGE.

10. ALL DAMAGE TO PUBLIC STREETS AND ROADS, INCLUDING HAUL ROUTES, TRAILS, OR STREET IMPROVEMENTS, OR TO PRIVATE PROPERTY, SHALL BE REPAIRED AT THE SOLE EXPENSE OF THE CONTRACTOR TO THE ORIGINAL CONDITIONS.

11. WHEN AN EXISTING ASPHALT STREET IS CUT, THE STREET MUST BE RESTORED TO A CONDITION EQUAL TO OR BETTER THAN ITS ORIGINAL CONDITION. THE FINISHED PATCH SHALL BLEND SMOOTHLY INTO THE EXISTING SURFACE. ALL LARGE PATCHES SHALL BE PAVED WITH AN ASPHALT LAY-DOWN MACHINE.

12. IF DEWATERING IS REQUIRED, THE CONTRACTOR SHALL NOTIFY THE ENGINEER. ANY DISCHARGE REQUIREMENTS SHALL BE COORDINATED WITH THE TOWN OF MOUNTAIN VILLAGE.

13. CONTRACTOR SHALL NOTIFY ALL RESIDENTS IN WRITING 24 HOURS PRIOR TO ANY SHUT-OFF IN SERVICE. THE NOTICES MUST HAVE CONTRACTOR'S PHONE NUMBER AND NAME OF CONTACT PERSON, AND EMERGENCY PHONE NUMBER FOR AFTER HOURS CALLS. ALL SHUT-OFF'S MUST BE APPROVED BY THE TOWN AND TOWN VALVES AND APPURTENANCES SHALL BE OPERATED BY TOWN PERSONNEL.

14. CONTRACTOR SHALL KEEP SITE CLEAN AND LITTER FREE (INCLUDING CIGARETTE BUTTS) BY PROVIDING A CONSTRUCTION DEBRIS TRASH CONTAINER AND A BEAR-PROOF POLY-CART TRASH CONTAINER, WHICH IS TO BE LOCKED AT ALL TIMES.

15. CONTRACTOR MUST BE AWARE OF ALL TREES TO REMAIN PER THE DESIGN AND APPROVAL PROCESS AND PROTECT THEM ACCORDINGLY.

16. THE CONTRACTOR SHALL PROVIDE UNDERGROUND UTILITY AS-BUILTS TO THE TOWN.

17. ALL STRUCTURAL FILL UNDER HARDSCAPE OR ROADS MUST BE COMPACTED TO 95% MODIFIED PROCTOR (MIN.) AT PLUS OR MINUS 2% OF THE OPTIMUM MOISTURE CONTENT. NON-STRUCTURAL FILL SHALL BE PLACED AT 90% (MIN.) MODIFIED PROCTOR.

18. UNSUITABLE MATERIAL SHALL BE REMOVED AS REQUIRED BY THE SOILS ENGINEER. ALL MATERIALS SUCH AS LUMBER, LOGS, BRUSH, TOPSOIL OR ORGANIC MATERIALS OR RUBBISH SHALL BE REMOVED FROM ALL AREAS TO RECEIVE COMPACTED FILL.

19. NO MATERIAL SHALL BE COMPACTED WHEN FROZEN.

20. NATIVE TOPSOIL SHALL BE STOCKPILED TO THE EXTENT FEASIBLE ON THE SITE FOR USE ON AREAS TO BE REVEGETATED.

21. THE CONTRACTOR SHALL BE RESPONSIBLE FOR DUST ABATEMENT AND EROSION CONTROL MEASURES DEEMED NECESSARY BY THE TOWN, IF CONDITIONS WARRANT THEM.

22. ALL DISTURBED GROUND SHALL BE RE-SEEDED WITH A TOWN-APPROVED SEED MIX. REFER TO THE LANDSCAPE PLAN.

23. THE CONTRACTOR IS REQUIRED TO PROTECT ALL EXISTING SURVEY MONUMENTS AND PROPERTY CORNERS DURING GRADING AND CONSTRUCTION.

24. ALL UNDERGROUND PIPE SHALL BE PROTECTED WITH BEDDING TO PROTECT THE PIPE FROM BEING DAMAGED.

25. HOT TUBS SHALL DRAIN TO THE SANITARY SEWER (OR PUMPED TO AA CLEAN-OUT).

26. THE UTILITY PLAN DEPICTS FINAL UTILITY LOCATIONS BUT HAS BEEN COMPLETED AT A PRELIMINARY STAGE. CONTRACTOR SHALL VERIFY ALIGNMENTS WITH THE ARCHITECT PRIOR TO CONSTRUCTION.

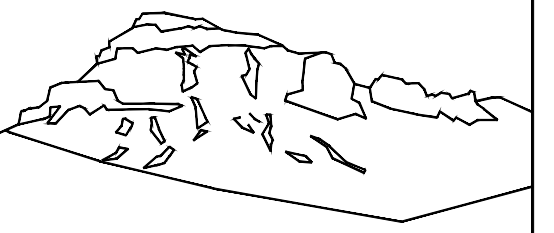

Uncompahgre
Engineering, LLC

P.O. Box 3945
Telluride, CO 81435
970-729-0683

SUBMISSIONS:

SUBMITTAL 2021-04-21

Moody Residence
Lot 510
Russell Drive
Mtn. Village, CO



CONTRACTOR TO REVIEW AND COMPARE ALL CHAPTERS AND INTERDISCIPLINARY DRAWINGS AND REPORT ANY DISCREPANCIES TO THE ARCHITECT PRIOR TO ANY FIELD WORK BEING DONE IN ACCORDANCE WITH AIA DOCUMENT A201

Civil Engineering

General Notes

C1

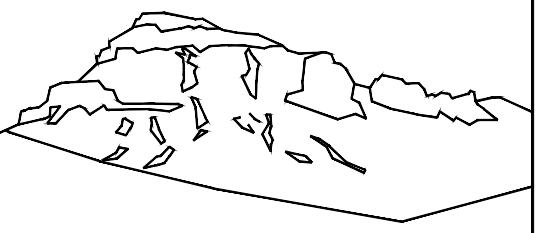

Uncompahgre
Engineering, LLC

P.O. Box 3945
Telluride, CO 81435
970-729-0683

SUBMISSIONS:
SUBMITTAL 2021-04-21

Moody Residence
Lot 510
Russell Drive
Mtn. Village, CO



CONTRACTOR TO REVIEW AND COMPARE ALL
CHAPTERS AND INTERDISCIPLINARY DRAWINGS
AND REPORT ANY DISCREPANCIES TO THE
ARCHITECT PRIOR TO ANY FIELD WORK BEING
DONE IN ACCORDANCE WITH AIA DOCUMENT A201

Civil Engineering
Site Plan
with
Driveway
Profile

C2.1

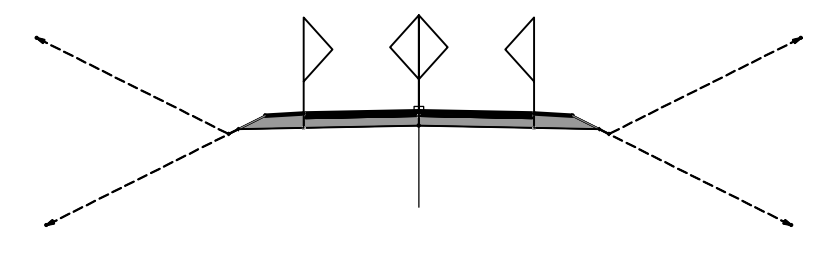
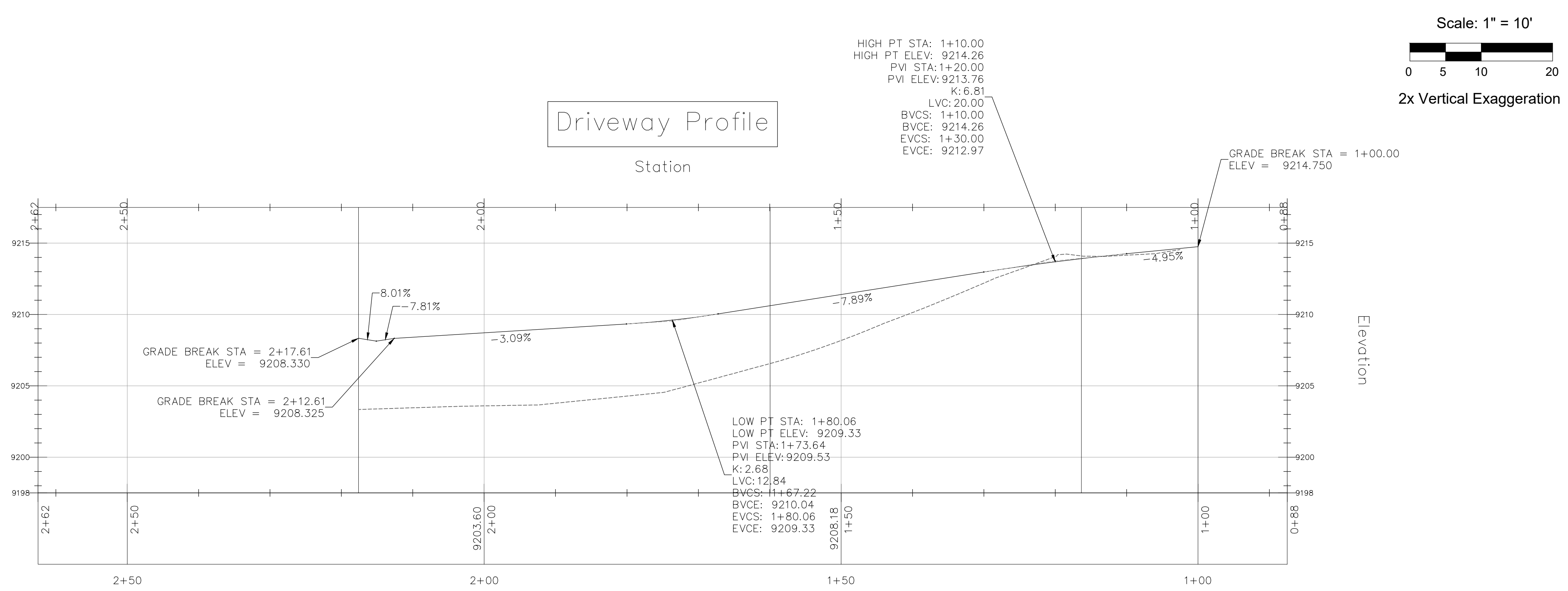
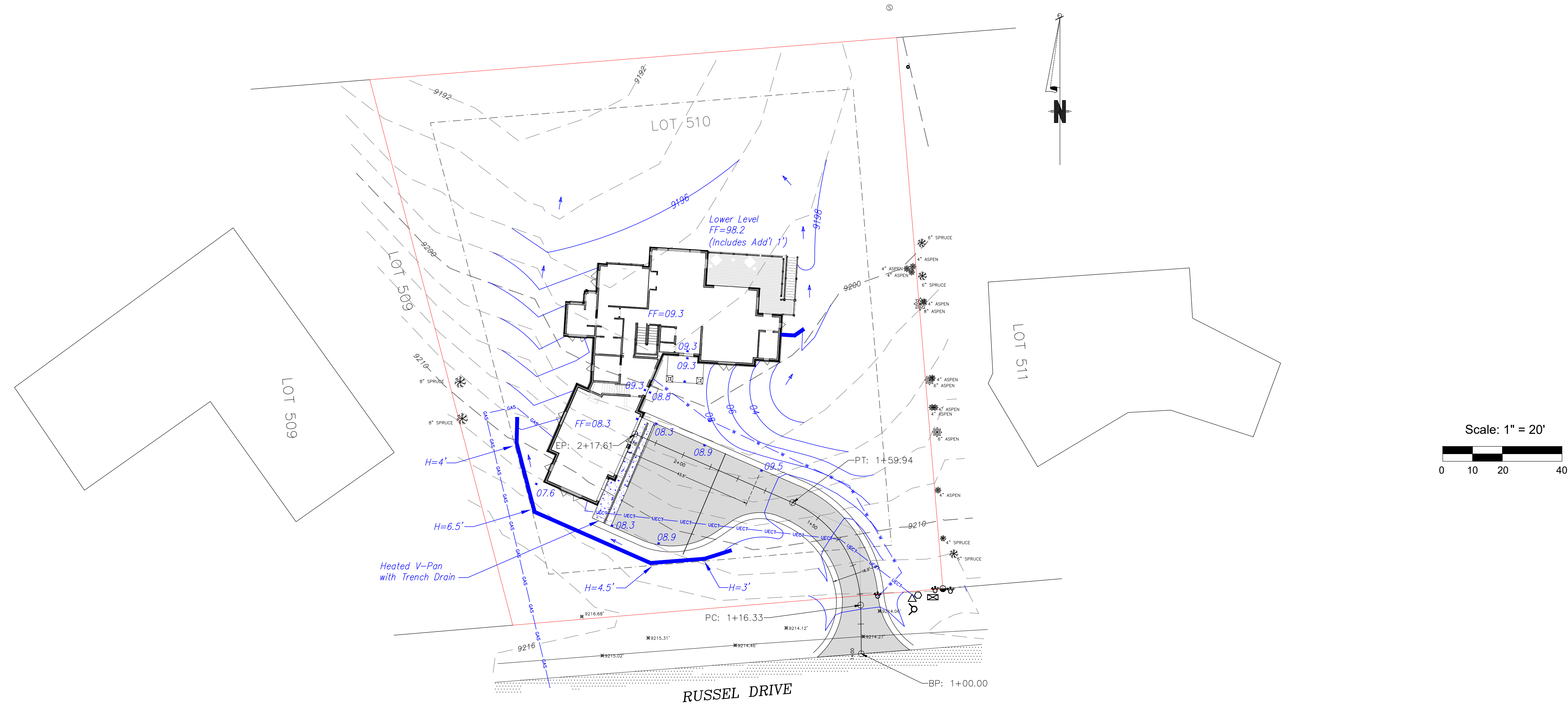

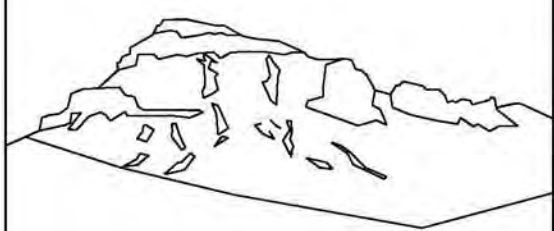

Uncompahgre
Engineering, LLC

P.O. Box 3945
Telluride, CO 81435
970-729-0683

SUBMISSIONS:

SUBMITTAL 2021-04-21
DRB Revisions 2021-05-10

Moody Residence
Lot 510
Russell Drive
Mtn. Village, CO



CONTRACTOR TO REVIEW AND COMPARE ALL
CHAPTERS AND INTERDISCIPLINARY DRAWINGS
AND REPORT ANY DISCREPANCIES TO THE
ARCHITECT PRIOR TO ANY FIELD WORK BEING
DONE IN ACCORDANCE WITH AIA DOCUMENT A201

Civil Engineering
Site Plan
with
Driveway
Profile

C2.1

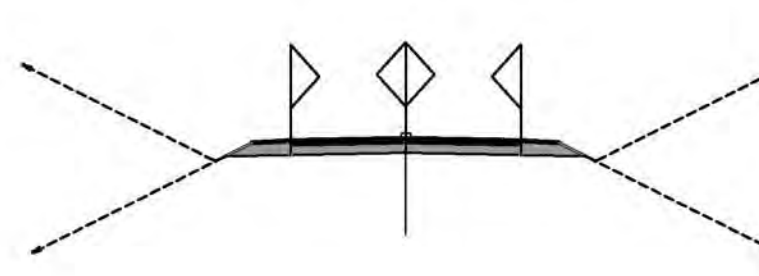
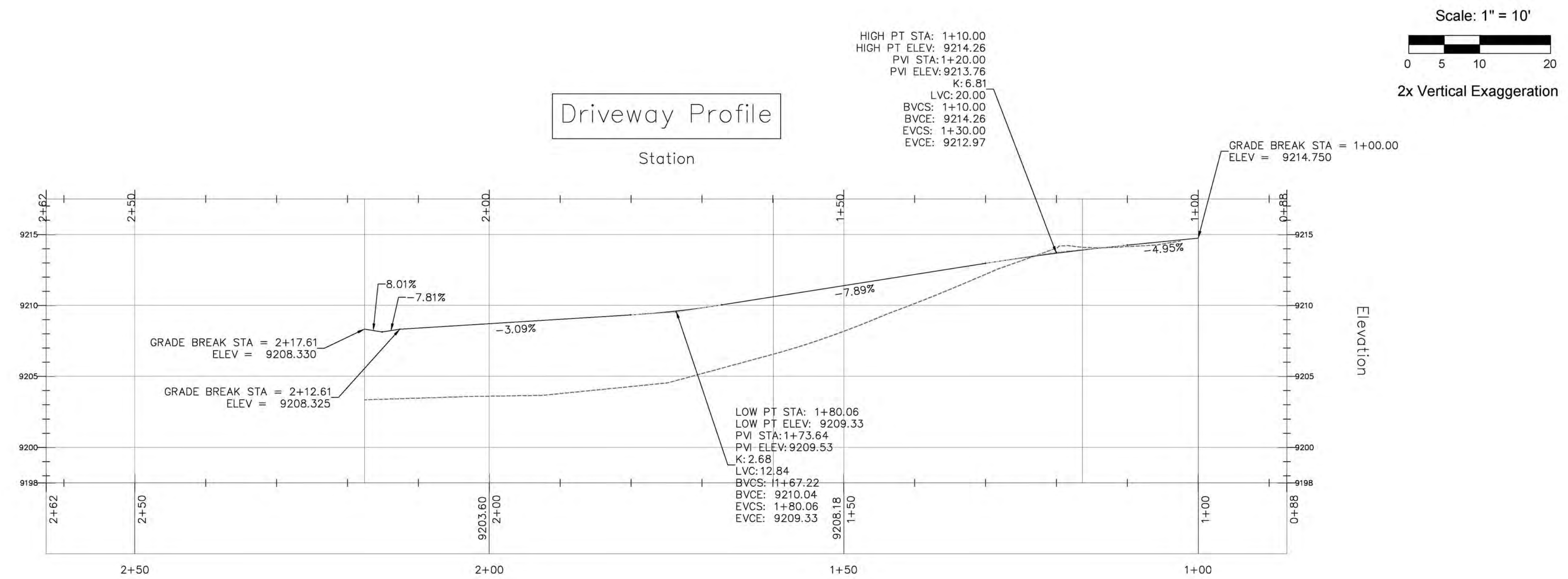
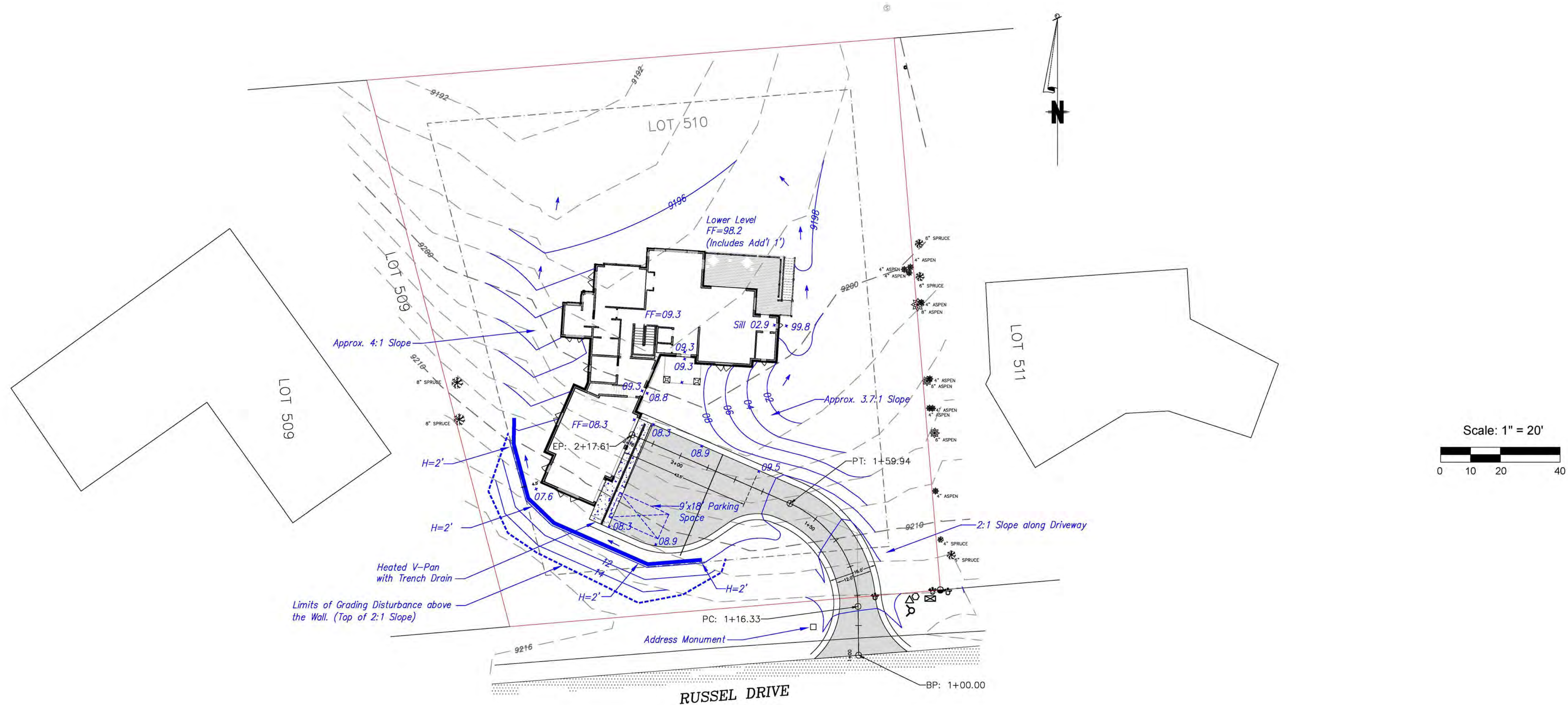

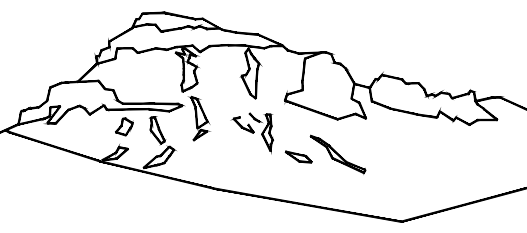

Uncompahgre
Engineering, LLC

P.O. Box 3945
Telluride, CO 81435
970-729-0683

SUBMISSIONS:
SUBMITTAL 2021-04-21

Moody Residence
Lot 510
Russell Drive
Mtn. Village, CO



CONTRACTOR TO REVIEW AND COMPARE ALL
CHAPTERS AND INTERDISCIPLINARY DRAWINGS
AND REPORT ANY DISCREPANCIES TO THE
ARCHITECT PRIOR TO ANY FIELD WORK BEING
DONE IN ACCORDANCE WITH AIA DOCUMENT A201

Utilities

C3

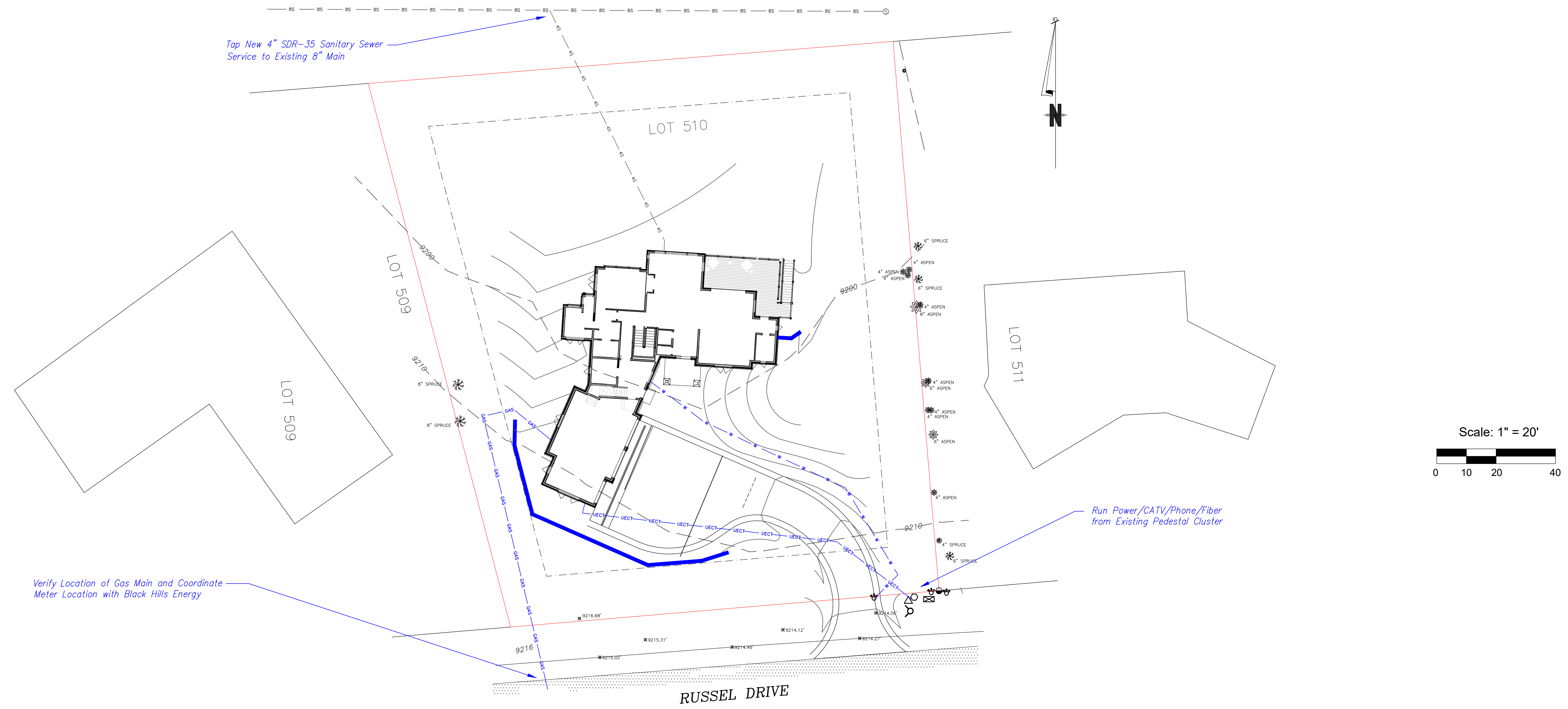

Tap New 4" SDR-35 Sanitary Sewer
Service to Existing 8" Main

Verify Location of Gas Main and Coordinate
Meter Location with Black Hills Energy

Run Power/CATV/Phone/Fiber
from Existing Pedestal Cluster

Scale: 1" = 20'

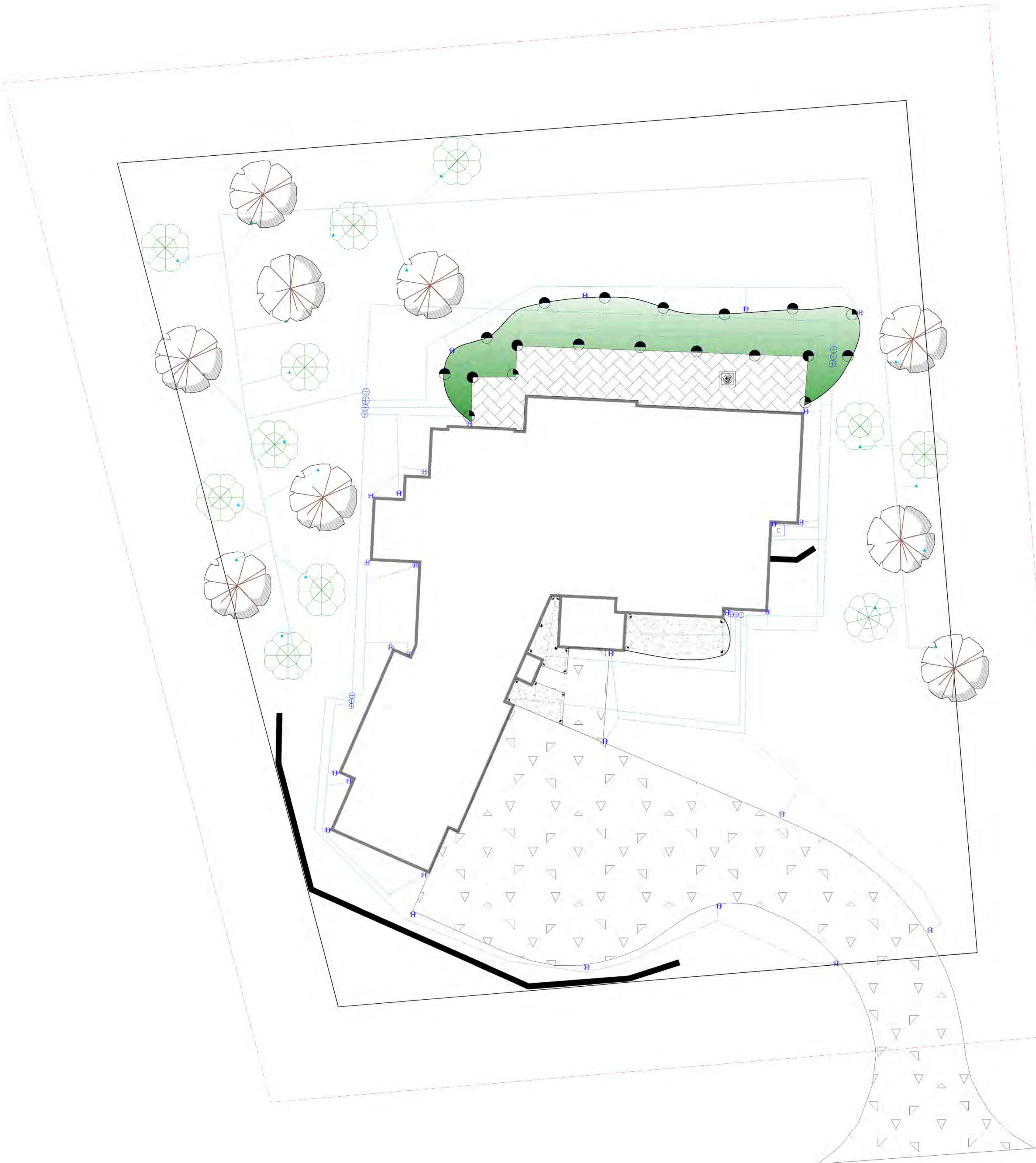

GENERAL NOTES:

1. CONTRACTOR SHALL PROVIDE ALL MATERIALS AND LABOR TO COMPLETE SCOPE OF WORK AS INDICATED IN DOCUMENTS.
2. ALL WORK SHALL BE EXECUTED IN ACCORDANCE WITH ALL FEDERAL, STATE AND LOCAL REGULATIONS, AND SHALL COMPLY WITH PREVAILING ACCESSIBILITY REQUIREMENTS. CONTRACTOR SHALL NOTIFY OWNER'S REPRESENTATIVE OF ANY PORTION OF DOCUMENTS WHICH CONFLICT WITH REGULATIONS PRIOR TO CONSTRUCTION.
3. CONTRACTOR IS RESPONSIBLE FOR SECURING ALL REQUIRED PERMITS, APPROVALS AND INSPECTIONS RELATED TO SCOPE OF WORK.
4. CONTRACTOR IS RESPONSIBLE FOR NOTIFYING OWNER'S REPRESENTATIVE OF REQUESTED SITE VISITS OR INSPECTIONS SEVEN (7) DAYS IN ADVANCE OF WORK.
5. DRAWINGS ARE BASED ON SURVEY DATA AND DESIGN DRAWINGS PROVIDED BY OTHERS. IT IS THE CONTRACTOR'S RESPONSIBILITY TO VERIFY EXISTING CONDITIONS AND SHALL NOTIFY OWNER'S REPRESENTATIVE OF ANY DISCREPANCIES BETWEEN DOCUMENTS AND ACTUAL SITE CONDITIONS PRIOR TO CONSTRUCTION.
6. DO NOT PROCEED WITH ANY PORTION OF WORK AS INDICATED IN DOCUMENTS IF OBSTRUCTIONS, DISCREPANCIES OR UNKNOWN CONDITIONS ARE ENCOUNTERED. NOTIFY OWNER'S REPRESENTATIVE IMMEDIATELY FOR DIRECTION ON HOW TO PROCEED.
7. CONTRACTOR SHALL COORDINATE ALL WORK WITH OTHER DISCIPLINES AND TRADES.
8. LIMITS OF WORK INDICATED ON DRAWINGS, IF ANY, ARE GENERAL IN NATURE AND ARE INTENDED TO DEFINE THE GENERAL VICINITY IN WHICH THE SCOPE OF WORK EXISTS. ACTUAL LIMITS OF WORK SHALL INCLUDE ALL AREAS NECESSARY TO COMPLETE SCOPE OF DESIGN INTENT.
9. REFERENCE TO "OWNER'S REPRESENTATIVE" IS MADE IN THESE DOCUMENTS, AND REFERS TO THE PROJECT OWNER OR DESIGNATED REPRESENTATIVE. IN ADDITION TO THE OWNER'S REPRESENTATIVE, THE CONTRACTOR SHALL CONTACT THE LANDSCAPE ARCHITECT FOR DESIGN CLARIFICATIONS OR ADDITIONAL INFORMATION RELATED TO SCOPE OF WORK.
10. UNLESS OTHERWISE NOTED, ALL EXISTING TREES SHALL BE PROTECTED. DO NOT PARK, DRIVE, OPERATE MACHINERY OR STORE MATERIALS WITHIN THE DRIPLINE OF EXISTING TREES.

REVEGETATION NOTES

- ALL DISTURBED AREAS WILL BE REVEGED
1. SUBSOIL SURFACE SHALL BE TILLER TO 6" DEPTH ON NON-FILL AREAS.
 2. TOPSOIL SHALL BE SPREAD TO A 4" MINIMUM DEPTH OVER ALL AREAS TO BE REVEGETATED EXCEPT ON SLOPES GREATER THAN 3:1.
 3. BROADCAST SEED SHALL BE DONE IMMEDIATELY AFTER TOPSOIL IS APPLIED TO MINIMIZE EROSION AND WEEDS.
 4. BROADCAST WITH SPECIFIED SEED MIX AND FOLLOW WITH DRY MULCHING (AGED PROPERLY), HYDRO MULCH, OR STRAW 2 BALES PER 1000 SF.
 5. SEED ALL AREAS LABELED "NATIVE GRASS WITH WILDFLOWERS" AT A RATE OF 1.5-2 POUNDS PER 1000 SF.
 6. SEED ALL AREAS LABELED "CUSTOM WILDFLOWER MIX" AT A RATE OF 1.5-2 POUNDS PER 1000 SF.
 7. SEED ALL AREAS LABELED "NATIVE GRASS" AT A RATE OF 2-3 POUNDS PER 1000 SF.
 8. ON SLOPES GREATER THAN 3:1 EROSION CONTROL BLANKET PINNED IN PLACE, OF HYDRO MULCH WITH ADDED TACTIFIER SHALL BE APPLIED.
 9. REVEGETATION SEED MIX TO BE USED:
 NATIVE GRASS SEED MIX (GENERAL REVEGETATION)
 WESTERN YARROW 5%
 TALL FESCUE 10%
 ARIZONA FESCUE 5%
 HARD FESCUE 5%
 CREEPING RED FESCUE 10%
 ALPINE BLUEGRASS 15%
 CANADA BLUEGRASS 10%
 PERENNIAL RYEGRASS 15%
 SLENDER WHEATGRASS 10%
 MOUNTAIN BROME 15%

PLANTING NOTES:

1. ALL NON-DIMENSIONED PLANT SYMBOLS, EDGING AND BED LINES ARE DIAGRAMMATIC AND SHALL BE SCALED FROM DRAWINGS.
2. STAKE ALL PROPOSED TREE LOCATIONS ON FINISH GRADE WITH DIFFERENT COLOR FLAGS FOR REVIEW AND APPROVAL BY OWNER'S REPRESENTATIVE PRIOR TO EXCAVATION. THE OWNER'S REPRESENTATIVE RESERVES THE RIGHT TO MAKE MINOR ADJUSTMENTS TO TREE LOCATIONS PRIOR TO EXCAVATION.
3. PAINT OR STRING ALL EDGING AND BED LINE LOCATIONS ON FINISH GRADE FOR REVIEW AND APPROVAL BY OWNER'S REPRESENTATIVE PRIOR TO INSTALLATION. THE OWNER'S REPRESENTATIVE SHALL RESERVE THE RIGHT TO MAKE MINOR ADJUSTMENTS TO LAYOUT OF PLANTING AREAS PRIOR TO EXCAVATION.
4. TREES SHALL BE PLANTED NO CLOSER THAN 4' TO PAVEMENT, CURB, EDGING, WALL OR UTILITIES UNLESS NOTED OTHERWISE.
5. TREES SHALL BE PLANTED NO CLOSER THAN 10' TO ANY STRUCTURE OR OVERHEAD UTILITY.
6. TREES OVERHANGING PEDESTRIAN AND VEHICULAR PAVEMENTS ARE INTENDED TO HAVE A MINIMUM CLEAR-TRUNK BRANCHING HEIGHT OF 7' AT MATURITY.
7. TREES OVERHANGING VISIBILITY EASEMENTS OR RIGHTS-OF-WAY ARE INTENDED TO HAVE A MINIMUM CLEAR-TRUNK BRANCHING HEIGHT OF 3' AT MATURITY.
8. ALL TREES, LAWN AND PLANTING AREAS TO RECEIVE 100% IRRIGATION COVERAGE FROM AUTOMATIC UNDERGROUND IRRIGATION SYSTEM UNLESS NOTED OTHERWISE.
9. FINISH GRADE SHALL BE APPROVED BY OWNER'S REPRESENTATIVE PRIOR TO PLANTING.
10. ANY QUANTITIES PROVIDED ON PLANS OR SCHEDULES ARE FOR INFORMATION AND CONTRACTOR CONVENIENCE ONLY. CONTRACTOR IS RESPONSIBLE FOR QUANTITY TAKE-OFFS AND SHALL PROVIDE FULL COVERAGE OF PLANTING AREAS AS INDICATED IN DRAWINGS.
11. ALL PLANTS SHALL MEET SIZE AND QUALITY SPECIFICATIONS AS INDICATED IN DOCUMENTS AND SHALL BE OF TOP QUALITY, VIGOROUS, HEALTHY CONDITION. THE OWNER'S REPRESENTATIVE RESERVES THE RIGHT TO REJECT PLANTS NOT MEETING SPECIFICATIONS.
12. ALL NEW PLANTS AND LAWNS SHALL BE FERTILIZED ACCORDING TO SOIL ANALYSIS RECOMMENDATIONS, SUPPLIER RECOMMENDATIONS, AS INDICATED IN DOCUMENTS OR AS APPROVED BY OWNER'S REPRESENTATIVE.
13. COORDINATE PLANTING WITH OTHER SECTIONS OF LANDSCAPE DOCUMENTS AND WITH WORK OF OTHER DISCIPLINES.

LEGEND

COMMON NAME	BOTANICAL NAME	SIZE
TREE, DECIDUOUS		
ASPEN, QUAKING	POPULUS TREMULOIDES	3"
ASPEN, QUAKING	POPULUS TREMULOIDES	3"
TREE, EVERGREEN		
SPRUCE, COLORADO BLUE	PICEA PUNGENS	10'
SPRUCE, COLORADO BLUE	PICEA PUNGENS	12'
SPRUCE, COLORADO BLUE	PICEA PUNGENS	8'
OTHER		
KENTUCKY BLUEGRASS		
PLANTER BEDS		
IRRIGATION		
IRRIGATION CLOCK		
RAINBIRD DVF VALVE		
POP-UP 90 DEGREE		
POP-UP 180 DEGREE		
POP-UP 270 DEGREE		
HUNTER ROTOR HEAD		
DRIP EMMITER		

Revision #: 00002
 Date: 5/24/2021

Scale:
 3/32" = 1'

Landscape Plan: 00002
 Moody

Landscape Design by: GarrettLBL
 Landscapes by Lance

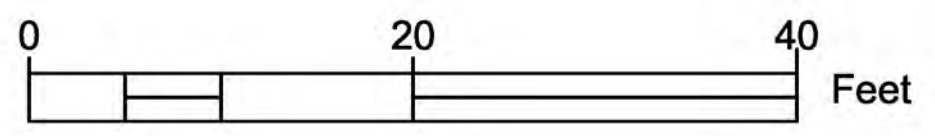
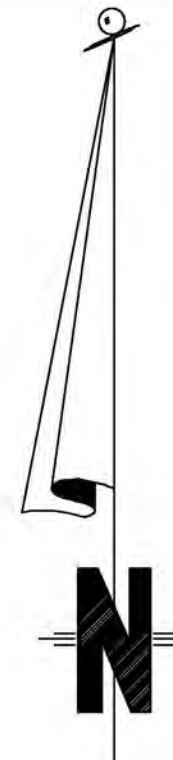
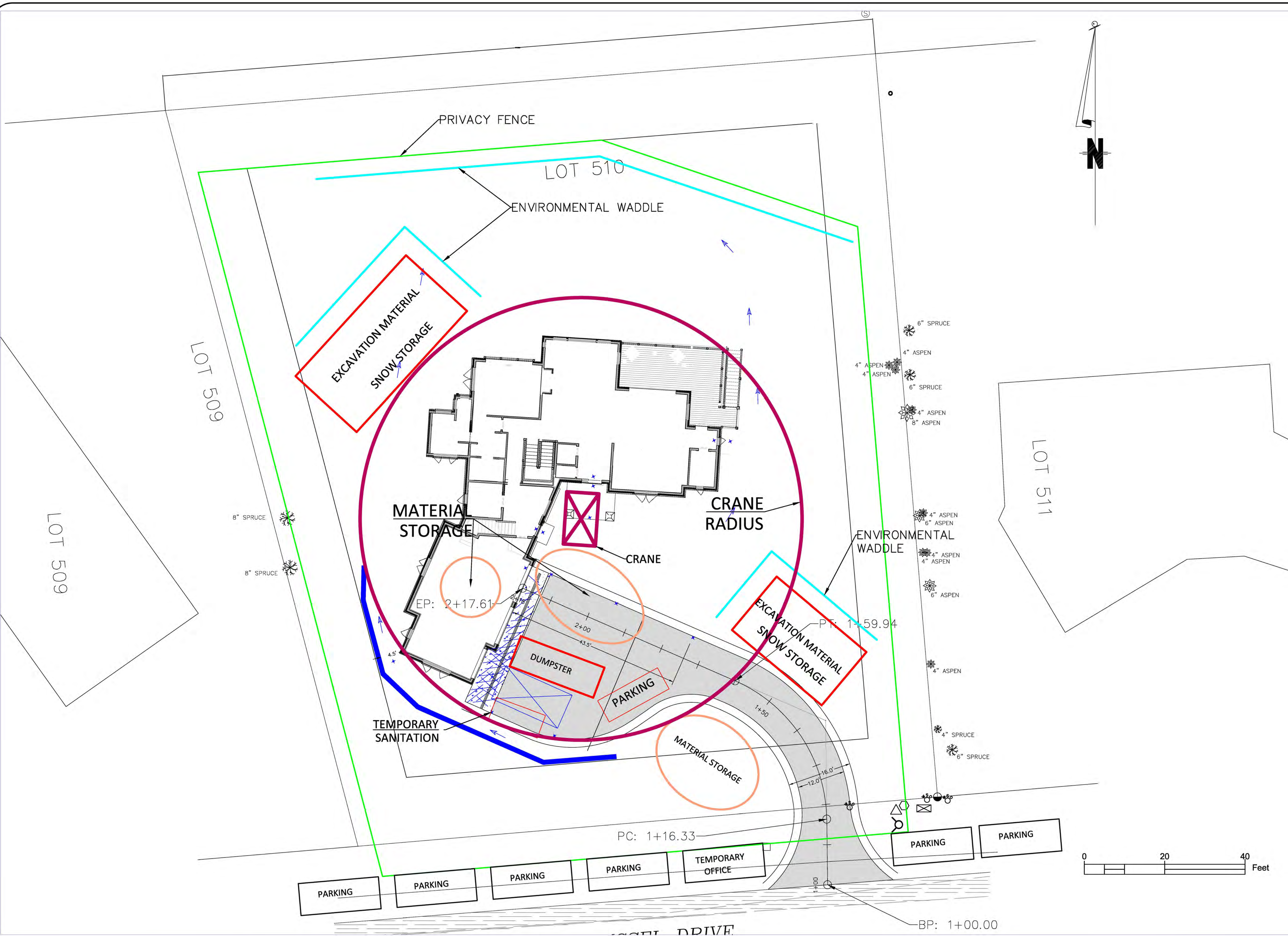

STAGING AREA

Firm Name and Address
 Kent S. DuCray
 208 31 Road
 Grand Junction, CO 81503
 970.260.7596
 kdacray@aol.com

Project Name and Address
 Lot 510 Topo.dwg

Drafter	KSD	Sheet	1	OF	1
Date	05/15/2021				
Scale	1"=10'-0"				

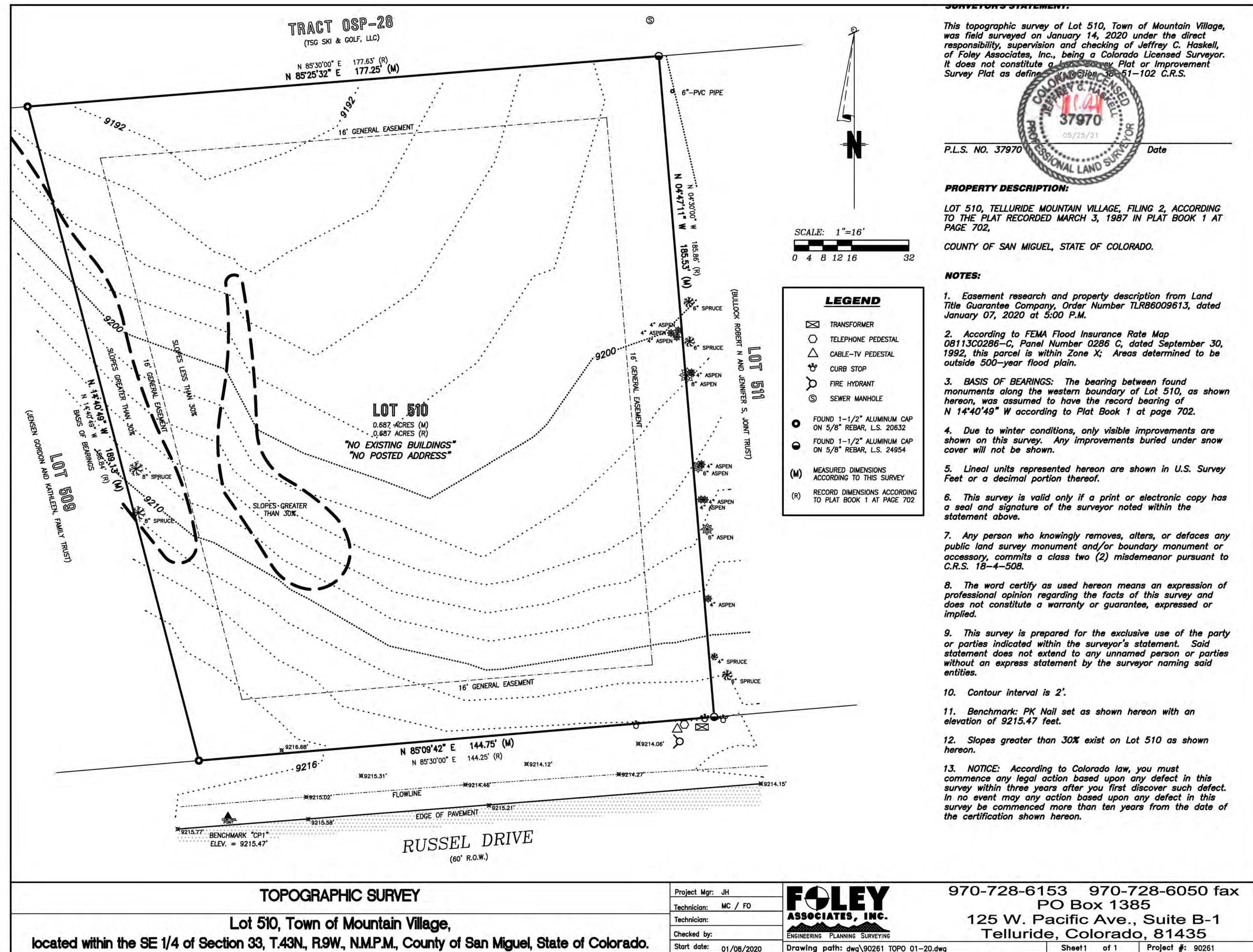

SURVEYOR'S STATEMENT:
 This topographic survey of Lot 510, Town of Mountain Village, was field surveyed on January 14, 2020 under the direct responsibility, supervision and checking of Jeffrey C. Haskell, of Foley Associates, Inc., being a Colorado Licensed Surveyor. It does not constitute a Survey Plat or Improvement Survey Plat as defined in C.R.S. 38-61-102 C.R.S.



P.L.S. NO. 37970 Date

PROPERTY DESCRIPTION:
 LOT 510, TELLURIDE MOUNTAIN VILLAGE, FILING 2, ACCORDING TO THE PLAT RECORDED MARCH 3, 1987 IN PLAT BOOK 1 AT PAGE 702,
 COUNTY OF SAN MIGUEL, STATE OF COLORADO.

- NOTES:**
- Easement research and property description from Land Title Guarantee Company, Order Number TL86009613, dated January 07, 2020 at 5:00 P.M.
 - According to FEMA Flood Insurance Rate Map 08113C0286-C, Panel Number 0286 C, dated September 30, 1992, this parcel is within Zone X; Areas determined to be outside 500-year flood plain.
 - BASIS OF BEARINGS:** The bearing between found monuments along the western boundary of Lot 510, as shown hereon, was assumed to have the record bearing of N 14°40'49" W according to Plat Book 1 at page 702.
 - Due to winter conditions, only visible improvements are shown on this survey. Any improvements buried under snow cover will not be shown.
 - Lineal units represented hereon are shown in U.S. Survey Feet or a decimal portion thereof.
 - This survey is valid only if a print or electronic copy has a seal and signature of the surveyor noted within the statement above.
 - Any person who knowingly removes, alters, or defaces any public land survey monument and/or boundary monument or accessory, commits a class two (2) misdemeanor pursuant to C.R.S. 18-4-508.
 - The word certify as used hereon means an expression of professional opinion regarding the facts of this survey and does not constitute a warranty or guarantee, expressed or implied.
 - This survey is prepared for the exclusive use of the party or parties indicated within the surveyor's statement. Said statement does not extend to any unnamed person or parties without an express statement by the surveyor naming said entities.
 - Contour interval is 2'.
 - Benchmark: PK Nail set as shown hereon with an elevation of 9215.47 feet.
 - Slopes greater than 30% exist on Lot 510 as shown hereon.
 - NOTICE:** According to Colorado law, you must commence any legal action based upon any defect in this survey within three years after you first discover such defect. In no event may any action based upon any defect in this survey be commenced more than ten years from the date of the certification shown hereon.

TOPOGRAPHIC SURVEY		Project Mgr: JH	FOLEY ASSOCIATES, INC. ENGINEERING PLANNING SURVEYING	970-728-6153 970-728-6050 fax		
Lot 510, Town of Mountain Village, located within the SE 1/4 of Section 33, T.43N, R.9W, N.M.P.M., County of San Miguel, State of Colorado.		Technician: MC / FD		PO Box 1385		
		Checked by:		125 W. Pacific Ave., Suite B-1		
		Start date: 01/08/2020		Telluride, Colorado, 81435		
		Drawing path: dwg\90261 TOPO 01-20.dwg	Sheet 1 of 1	Project #: 90261		

1 EXISTING SURVEY
 1/16" = 1'-0"



EXISTING SURVEY

P.O. BOX 1665
 GOLDEN, BRITISH COLUMBIA, CANADA
 V0A 1H0
 OFFICE: (250) 348-2231
 FAX: (250) 348-2244
 WEB: WWW.CANADIANTIMBERFRAMES.COM

MOODY RESIDENCE
 20130
 2021-05-25 12:16:16 PM

ISSUED FOR: DRB REVIEW

THESE DRAWINGS ARE THE PROPERTY OF CANADIAN TIMBERFRAMES LTD. AND MAY NOT BE REPRODUCED OR COPIED WITHOUT OUR WRITTEN CONSENT. ALL DESIGNS, IDEAS, AND CONCEPTS DEVELOPED IN THIS DRAWING SHALL REMAIN AT ALL TIMES THE SOLE PROPERTY OF CANADIAN TIMBERFRAMES LTD.

A-1.5

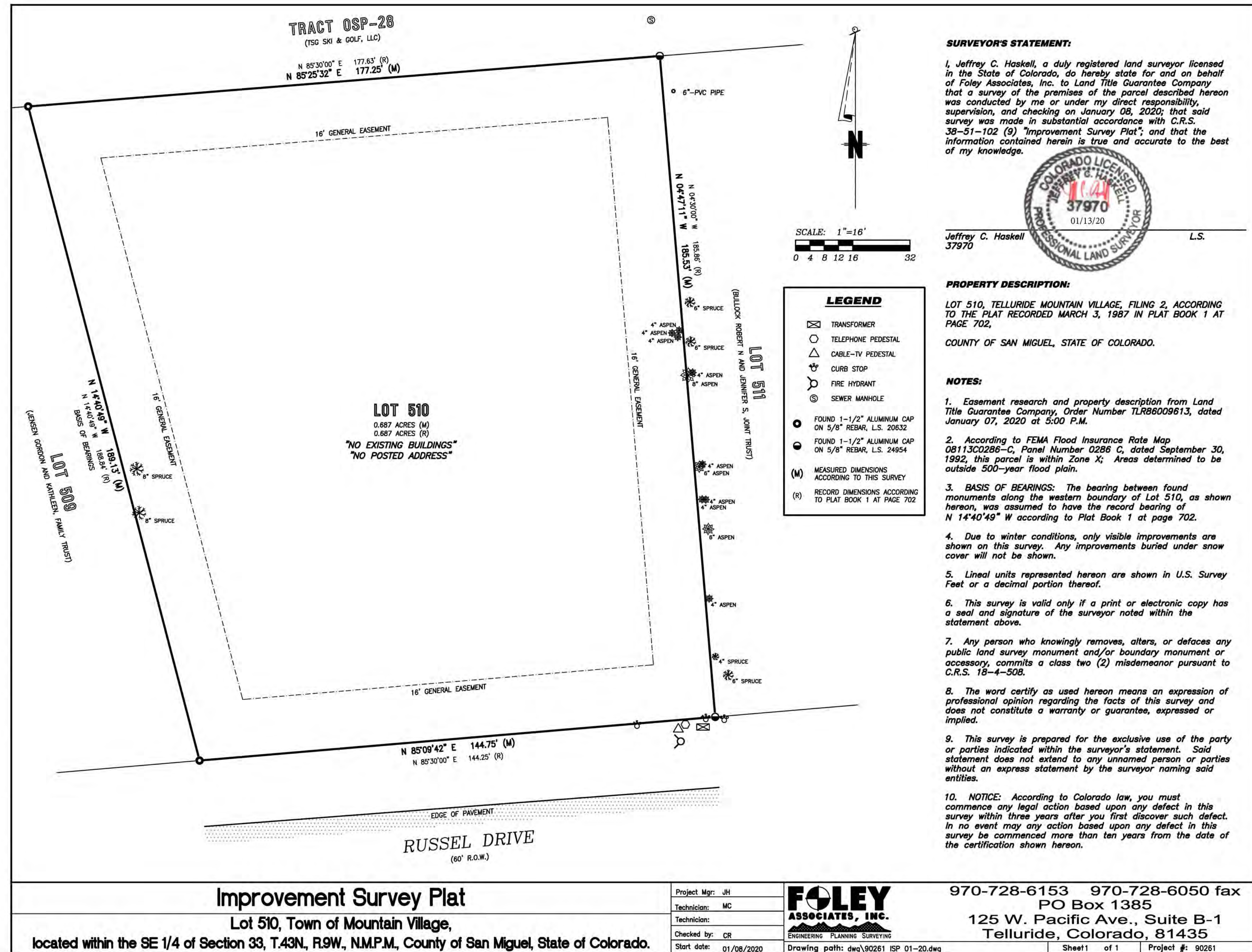

SURVEYOR'S STATEMENT:

I, Jeffrey C. Haskell, a duly registered land surveyor licensed in the State of Colorado, do hereby state for and on behalf of Foley Associates, Inc. to Land Title Guarantee Company that a survey of the premises of the parcel described hereon was conducted by me or under my direct responsibility, supervision, and checking on January 08, 2020; that said survey was made in substantial accordance with C.R.S. 38-51-102 (9) "Improvement Survey Plat"; and that the information contained herein is true and accurate to the best of my knowledge.



Jeffrey C. Haskell
37970 L.S.

PROPERTY DESCRIPTION:

LOT 510, TELLURIDE MOUNTAIN VILLAGE, FILING 2, ACCORDING TO THE PLAT RECORDED MARCH 3, 1987 IN PLAT BOOK 1 AT PAGE 702.

COUNTY OF SAN MIGUEL, STATE OF COLORADO.

NOTES:

- Easement research and property description from Land Title Guarantee Company, Order Number TLR86009613, dated January 07, 2020 at 5:00 P.M.
- According to FEMA Flood Insurance Rate Map 08113C0286-C, Panel Number 0286 C, dated September 30, 1992, this parcel is within Zone X; Areas determined to be outside 500-year flood plain.
- BASIS OF BEARINGS:** The bearing between found monuments along the western boundary of Lot 510, as shown hereon, was assumed to have the record bearing of N 14°40'49" W according to Plat Book 1 at page 702.
- Due to winter conditions, only visible improvements are shown on this survey. Any improvements buried under snow cover will not be shown.
- Lineal units represented hereon are shown in U.S. Survey Feet or a decimal portion thereof.
- This survey is valid only if a print or electronic copy has a seal and signature of the surveyor noted within the statement above.
- Any person who knowingly removes, alters, or defaces any public land survey monument and/or boundary monument or accessory, commits a class two (2) misdemeanor pursuant to C.R.S. 18-4-508.
- The word certify as used hereon means an expression of professional opinion regarding the facts of this survey and does not constitute a warranty or guarantee, expressed or implied.
- This survey is prepared for the exclusive use of the party or parties indicated within the surveyor's statement. Said statement does not extend to any unnamed person or parties without an express statement by the surveyor naming said entities.
- NOTICE:** According to Colorado law, you must commence any legal action based upon any defect in this survey within three years after you first discover such defect. In no event may any action based upon any defect in this survey be commenced more than ten years from the date of the certification shown hereon.

Improvement Survey Plat

Lot 510, Town of Mountain Village,
located within the SE 1/4 of Section 33, T.43N, R.9W, N.M.P.M., County of San Miguel, State of Colorado.

Project Mgr: JH	
Technician: MC	
Checked by: CR	
Start date: 01/08/2020	

970-728-6153 970-728-6050 fax
PO Box 1385
125 W. Pacific Ave., Suite B-1
Telluride, Colorado, 81435

1 IMPROVEMENT SURVEY PLAT
1/16" = 1'-0"



P.O. BOX 1665
GOLDEN, BRITISH COLUMBIA, CANADA
V0A 1H0
OFFICE: (250) 348-2231
FAX: (250) 348-2241
WEB: WWW.CANADIANTIMBERFRAMES.COM

IMPROVEMENT SURVEY PLAT

MOODY RESIDENCE
20130
2021-05-25 12:16:22 PM

ISSUED FOR: DRB REVIEW

THESE DRAWINGS ARE THE PROPERTY OF CANADIAN TIMBERFRAMES LTD. AND MAY NOT BE REPRODUCED OR COPIED WITHOUT OUR WRITTEN CONSENT. ALL DESIGNS, IDEAS, AND CONCEPTS DEVELOPED IN THIS DRAWING SHALL REMAIN AT ALL TIMES THE SOLE PROPERTY OF CANADIAN TIMBERFRAMES LTD.

A-1.6

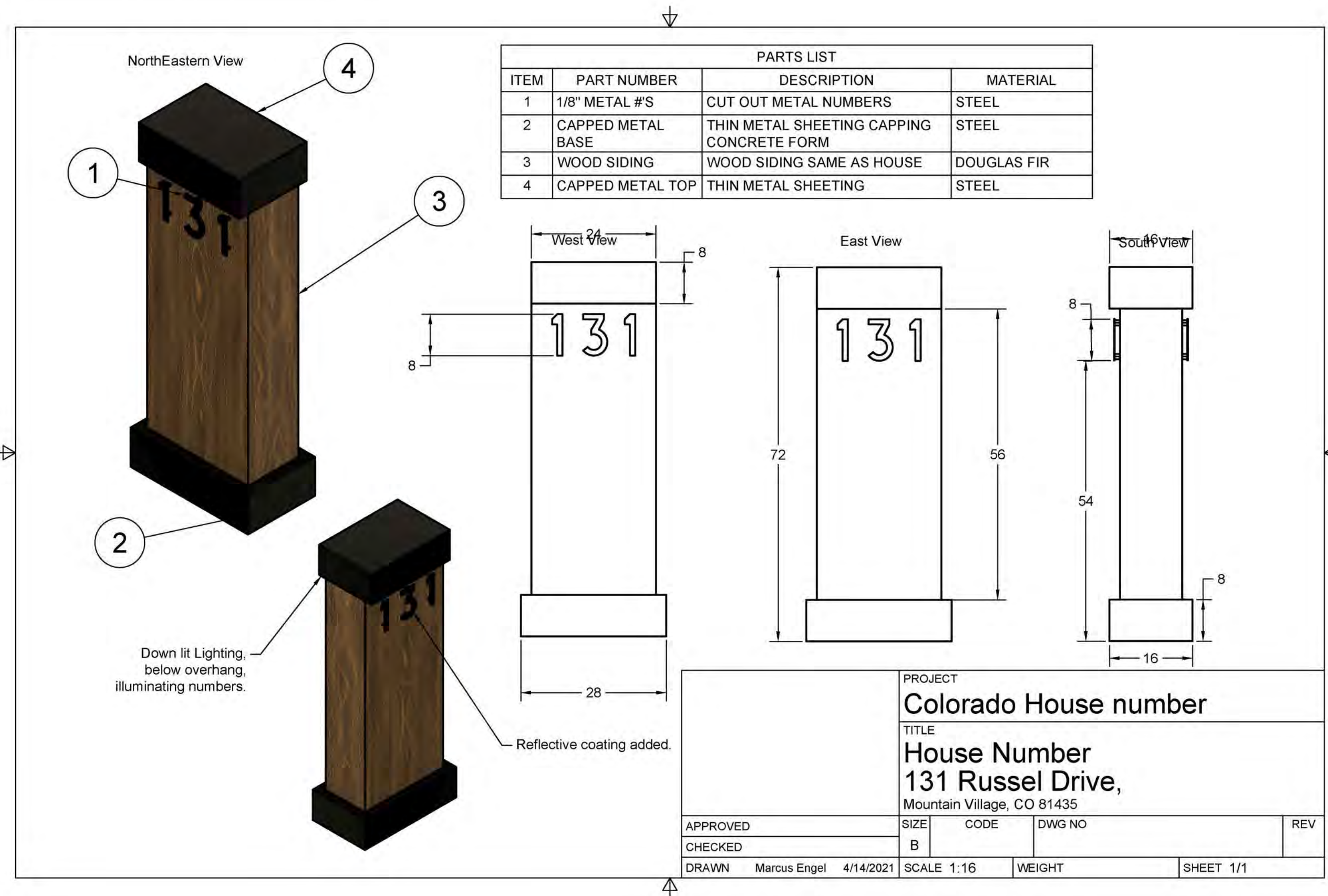

HOUSE NUMBER - NORTH WEST VIEW



HOUSE NUMBER - SOUTH EAST VIEW



HOUSE NUMBER - WEST VIEW



ADDRESS MONUMENT

P.O. BOX 1665
 GOLDEN, BRITISH COLUMBIA, CANADA
 V0A 1H0

OFFICE: (250) 348-2231
 FAX: (250) 348-2241
 WEB: WWW.CANADIANTIMBERFRAMES.COM

MOODY RESIDENCE
 20130
 2021-05-25 12:16:23 PM

ISSUED FOR: DRB REVIEW

THESE DRAWINGS ARE THE PROPERTY OF CANADIAN TIMBERFRAMES LTD. AND MAY NOT BE REPRODUCED OR COPIED WITHOUT OUR WRITTEN CONSENT. ALL DESIGNS, IDEAS, AND CONCEPTS DEVELOPED IN THIS DRAWING SHALL REMAIN AT ALL TIMES THE SOLE PROPERTY OF CANADIAN TIMBERFRAMES LTD.

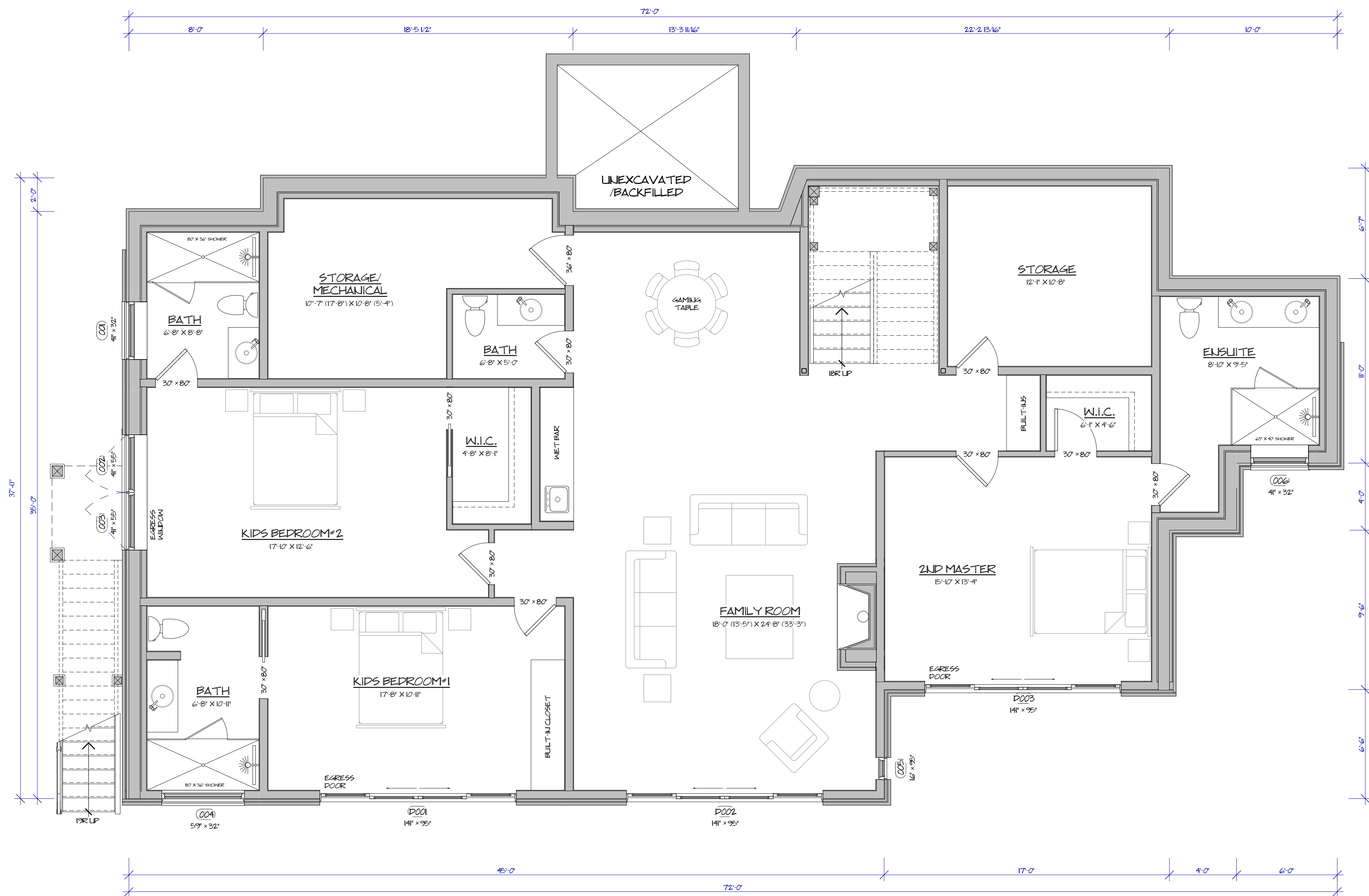

1 BASEMENT FLOOR PLAN
1/4" = 1'-0"

BASEMENT	2344 SF
MAIN FLOOR	2163 SF
SECOND FLOOR	620 SF
GROSS FLOOR AREA	5127 SF
GARAGE	845 SF
TOTAL GARAGE AREA	845 SF



P.O. BOX 1665
GOLDEN, BRITISH COLUMBIA, CANADA
V0A 1H0
OFFICE: (250) 348-2231
FAX: (250) 348-2241
WEB: WWW.CANADIANTIMBERFRAMES.COM

BASEMENT FLOOR PLAN

MOODY RESIDENCE
20130
2021-05-25 12:16:25 PM

ISSUED FOR: DRB REVIEW

THESE DRAWINGS ARE THE PROPERTY OF CANADIAN TIMBERFRAMES LTD. AND MAY NOT BE REPRODUCED OR COPIED WITHOUT OUR WRITTEN CONSENT. ALL DESIGNS, IDEAS, AND CONCEPTS DEVELOPED IN THIS DRAWING SHALL REMAIN AT ALL TIMES THE SOLE PROPERTY OF CANADIAN TIMBERFRAMES LTD.

A-2.1

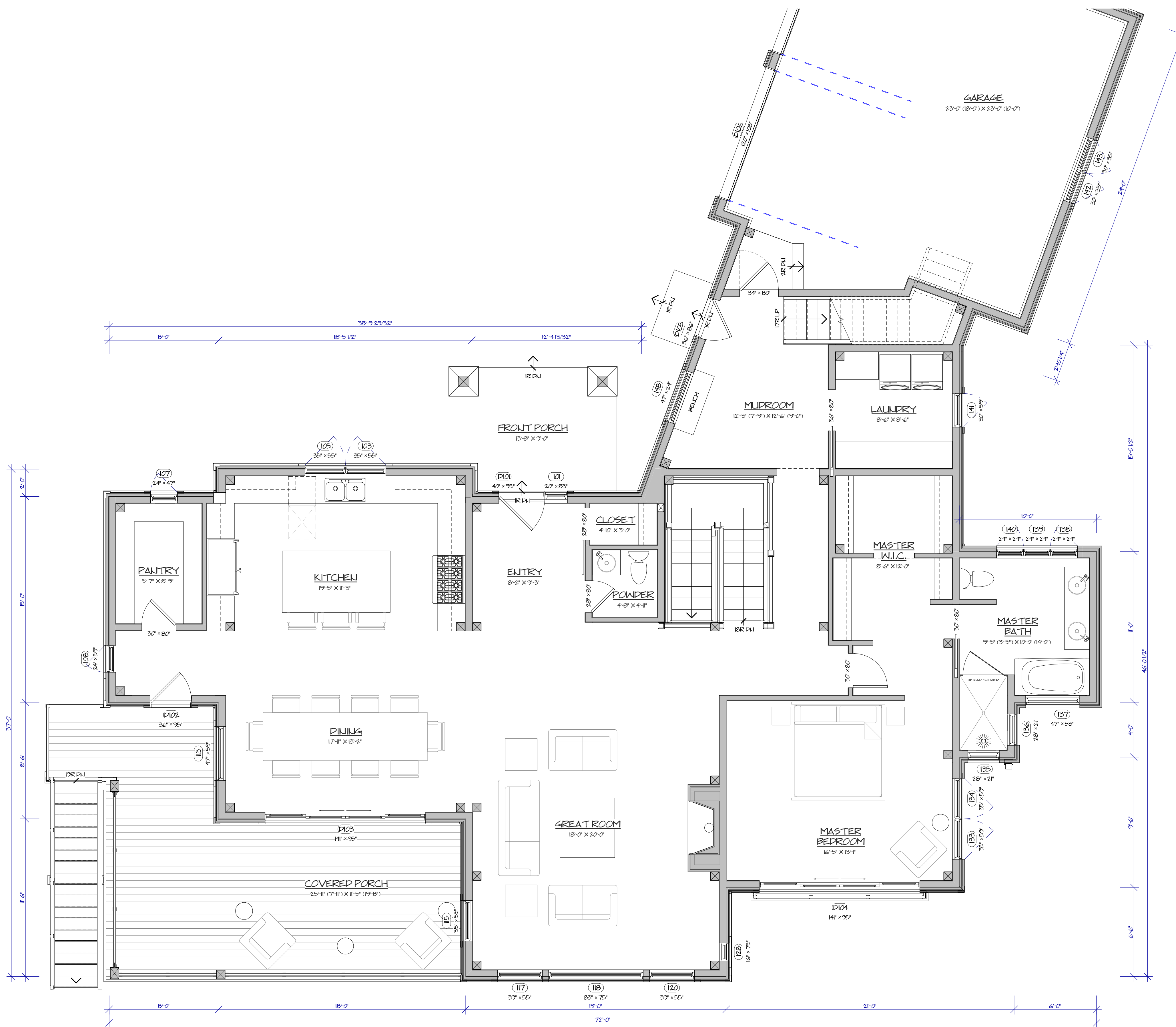

1 MAIN FLOOR PLAN - HOUSE
1/4" = 1'-0"

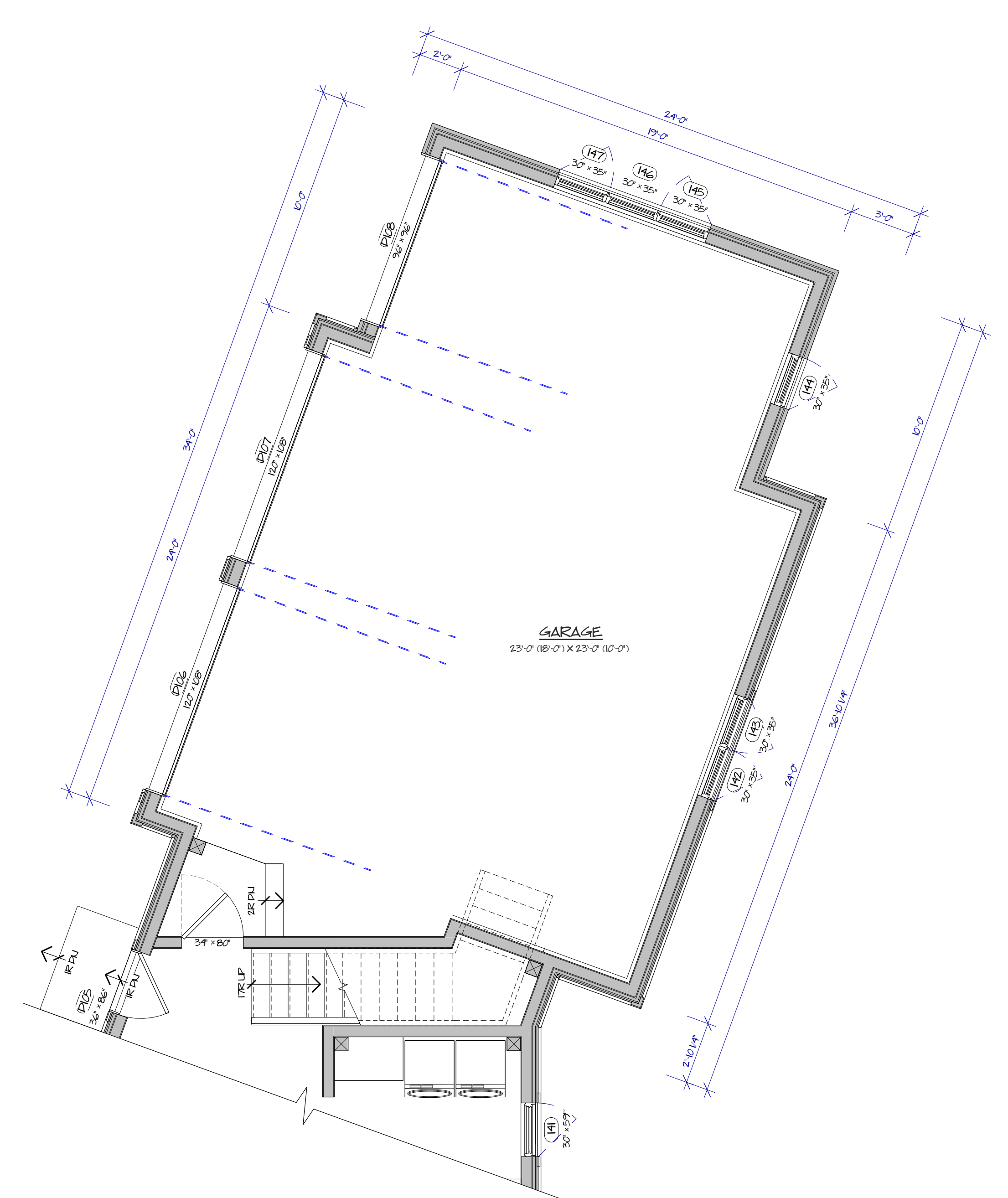

2 MAIN FLOOR PLAN - GARAGE
1/4" = 1'-0"

BASEMENT	2344 SF
MAIN FLOOR	2163 SF
SECOND FLOOR	620 SF
GROSS FLOOR AREA	5127 SF
GARAGE	845 SF
TOTAL GARAGE AREA	845 SF



MAIN FLOOR PLAN

P.O. BOX 1665
GOLDEN, BRITISH COLUMBIA, CANADA
V0A 1H0
OFFICE: (250) 348-2231
FAX: (250) 348-2241
WEB: WWW.CANADIANTIMBERFRAMES.COM

MOODY RESIDENCE
20130
2021-05-25 12:16:29 PM

ISSUED FOR: DRB REVIEW

THESE DRAWINGS ARE THE PROPERTY OF CANADIAN TIMBERFRAMES LTD. AND MAY NOT BE REPRODUCED OR COPIED WITHOUT OUR WRITTEN CONSENT. ALL DESIGNS, IDEAS, AND CONCEPTS DEVELOPED IN THIS DRAWING SHALL REMAIN AT ALL TIMES THE SOLE PROPERTY OF CANADIAN TIMBERFRAMES LTD.

A-2.2

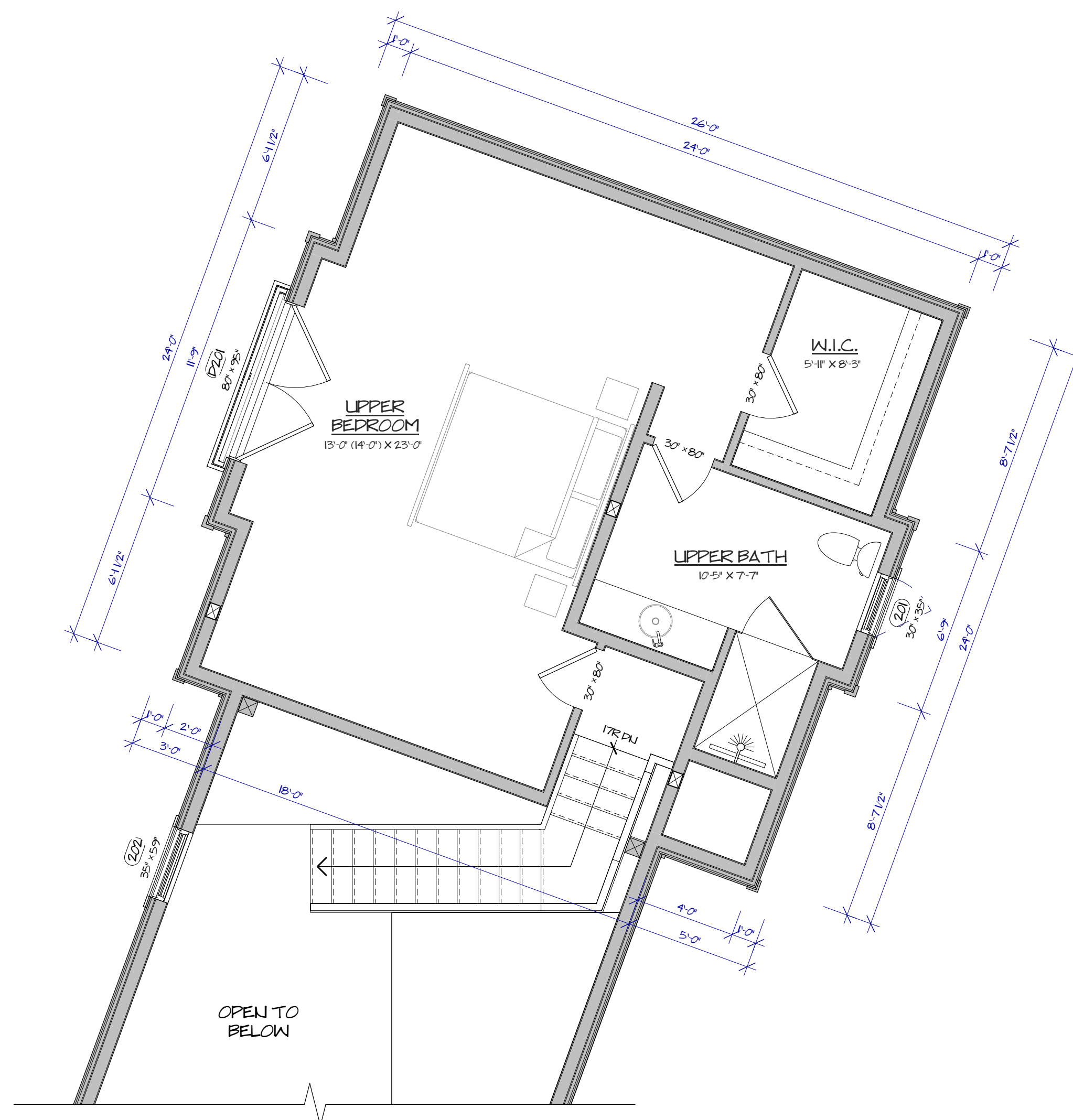

1 SECOND FLOOR PLAN
1/4" = 1'-0"

BASEMENT	2344 SF
MAIN FLOOR	2163 SF
SECOND FLOOR	620 SF
GROSS FLOOR AREA	5127 SF
GARAGE	845 SF
TOTAL GARAGE AREA	845 SF



P.O. BOX 1665
GOLDEN, BRITISH COLUMBIA, CANADA
V0A 1H0

OFFICE: (250) 348-2231
FAX: (250) 348-2241
WEB: WWW.CANADIANTIMBERFRAMES.COM

SECOND FLOOR PLAN

MOODY RESIDENCE
20130
2021-05-25 12:16:30 PM

ISSUED FOR: DRB REVIEW

THESE DRAWINGS ARE THE PROPERTY OF CANADIAN TIMBERFRAMES LTD. AND MAY NOT BE REPRODUCED OR COPIED WITHOUT OUR WRITTEN CONSENT. ALL DESIGNS, IDEAS, AND CONCEPTS DEVELOPED IN THIS DRAWING SHALL REMAIN AT ALL TIMES THE SOLE PROPERTY OF CANADIAN TIMBERFRAMES LTD.

A-2.3

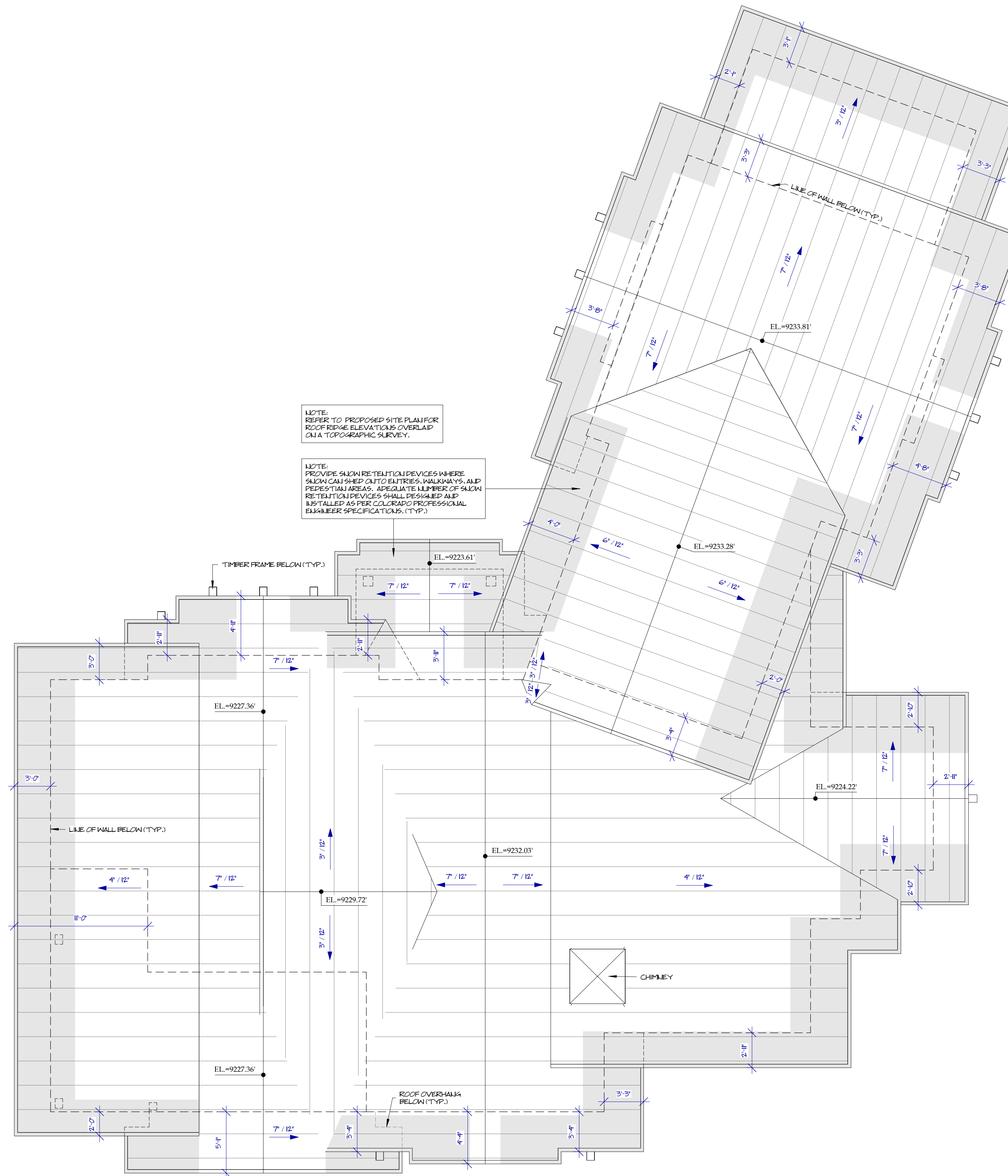

NOTE:
REFER TO PROPOSED SITE PLAN FOR
ROOF RIDGE ELEVATIONS OVERLAP
ON A TOPOGRAPHIC SURVEY.

NOTE:
PROVIDE SNOW RETENTION DEVICES WHERE
SNOW CAN SHEED OUT TO ENTRIES, WALKWAYS, AND
PEDESTRIAN AREAS. ADEQUATE NUMBER OF SNOW
RETENTION DEVICES SHALL BE SHOWN AND
INSTALLED AS PER COLORADO PROFESSIONAL
ENGINEER SPECIFICATIONS. (TYP.)

1 ROOF PLAN
3/16" = 1'-0"



ROOF PLAN

P.O. BOX 1665
GOLDEN, BRITISH COLUMBIA, CANADA
V0A 1H0
OFFICE: (250) 348-2231
FAX: (250) 348-2241
WEB: WWW.CANADIANTIMBERFRAMES.COM

MOODY RESIDENCE
20130
2021-05-25 12:16:32 PM

ISSUED FOR: DRB REVIEW

THESE DRAWINGS ARE THE PROPERTY OF CANADIAN TIMBERFRAMES LTD. AND MAY NOT BE REPRODUCED OR COPIED WITHOUT OUR WRITTEN CONSENT. ALL DESIGNS, IDEAS, AND CONCEPTS DEVELOPED IN THIS DRAWING SHALL REMAIN AT ALL TIMES THE SOLE PROPERTY OF CANADIAN TIMBERFRAMES LTD.

MOODY RESIDENCE EXTERIOR LIGHTING CALCULATIONS

Date: 5/12/2021
 Filename: MAIN Level Ext Calc_V1.AGI
 CALCULATION BY: AC / CS

ROOM CHARACTERISTICS

CEILING HEIGHT:
 CEILING REFLECTANCE: 0.3
 WALL REFLECTANCE: 0.3
 FLOOR REFLECTANCE: 0.2
 OTHER IMPORTANT INFORMATION:
 FIXTURES NOTED WITH A CIRCUIT NUMBER WILL BE PART OF A CONTROL SYSTEM.
 ALL LUMEN OUTPUTS ARE ADJUSTED AS NOTED IN FIXTURE SCHEDULE.

Luminaire Schedule

Symbol	Qty	Label	Description	Lumens/Lamp	LLF	Tag
+	6	49278AZTLED	Westley LED Ext Sconce	450	1.000	L1
+	2	102171228CHI-097 GB EN3S-LO93	40 Deg Adj DL	980	1.000	L2
+	7	102171228CHI-098 GB EN3S-LO93	20 Deg Adj DL	980	1.000	L3
⊙	2	IES_E16-11W-NFL	29 Deg Adj Cyl	777	1.000	L5
⊙	2	IES_E16-11W-FL	48 Deg Adj Cyl	777	1.000	L6
+	2	WL-LED100-C-BK	LED Step Light	30.8	1.000	L7
—	10	TORQ-05-SW-3_0-30-WET-40D-ST	40 Deg Linear LED	230	1.000	L4
—	2	TORQ-04-SW-3_0-30-WET-GZR-ST	12 Deg Linear LED	163	1.000	L8

Numeric Summary

Label	Units	Avg	Max	Min	Avg/Min	Max/Min
Driveway Entry_Planar	Fc	0.05	5.1	0.0	N.A.	N.A.
Entry	Fc	2.06	33.8	0.0	N.A.	N.A.
Garage	Fc	0.86	9.1	0.0	N.A.	N.A.
Lower Level	Fc	0.31	7.5	0.0	N.A.	N.A.
Main Deck	Fc	15.22	46.1	5.9	2.58	7.81
Property NE Edge	Fc	0.00	0.2	0.0	N.A.	N.A.
Stairs_Planar	Fc	9.50	14.0	5.5	1.73	2.55



***Lighting calculation results are based on photometric data provided by manufacturers and industry standards regarding reflectance of surfaces.

CONSULTANTS

Architect
 TBD

Interior Architect
 TBD

Landscape Architect
 TBD

General Contractor
 TBD

Electrical Contractor
 TBD

REVISIONS

DATE	DESCRIPTION
05.12.2021	DRB SUBMISSION

PROJECT
MOODY RESIDENCE
 131 RUSSEL DRIVE
 MOUNTAIN VILLAGE, CO 81435

SITE ORIENTATION

DRAWING TITLE
**EXTERIOR
 LIGHTING CALC**

DRAWING ISSUE

ISSUE:	DRB SUBMISSION
DATE:	12 MAY 2021
DRAWING:	ARCH D - 24 X 36
SCALE:	AS NOTED ON DRAWING
JOB #:	NA
DRAWN BY:	AC
CHECKED BY:	CS

DRAWING NO.

L1.2

CONSULTANTS

Architect
TBD

Interior Architect
TBD

Landscape Architect
TBD

General Contractor
TBD

Electrical Contractor
TBD

REVISIONS

△	DATE	DESCRIPTION
△	05.12.2021	DRB SUBMISSION

PROJECT

MOODY RESIDENCE
131 RUSSEL DRIVE
MOUNTAIN VILLAGE, CO 81435

SITE ORIENTATION

DRAWING TITLE

LOWER LEVEL
LIGHTING PLAN

DRAWING ISSUE

ISSUE:	DRB SUBMISSION
DATE:	12 MAY 2021
DRAWING:	ARCH D - 24 X 36
SCALE:	AS NOTED ON DRAWING
JOB #:	NA
DRAWN BY:	AC
CHECKED BY:	CS

DRAWING NO.

L1.0

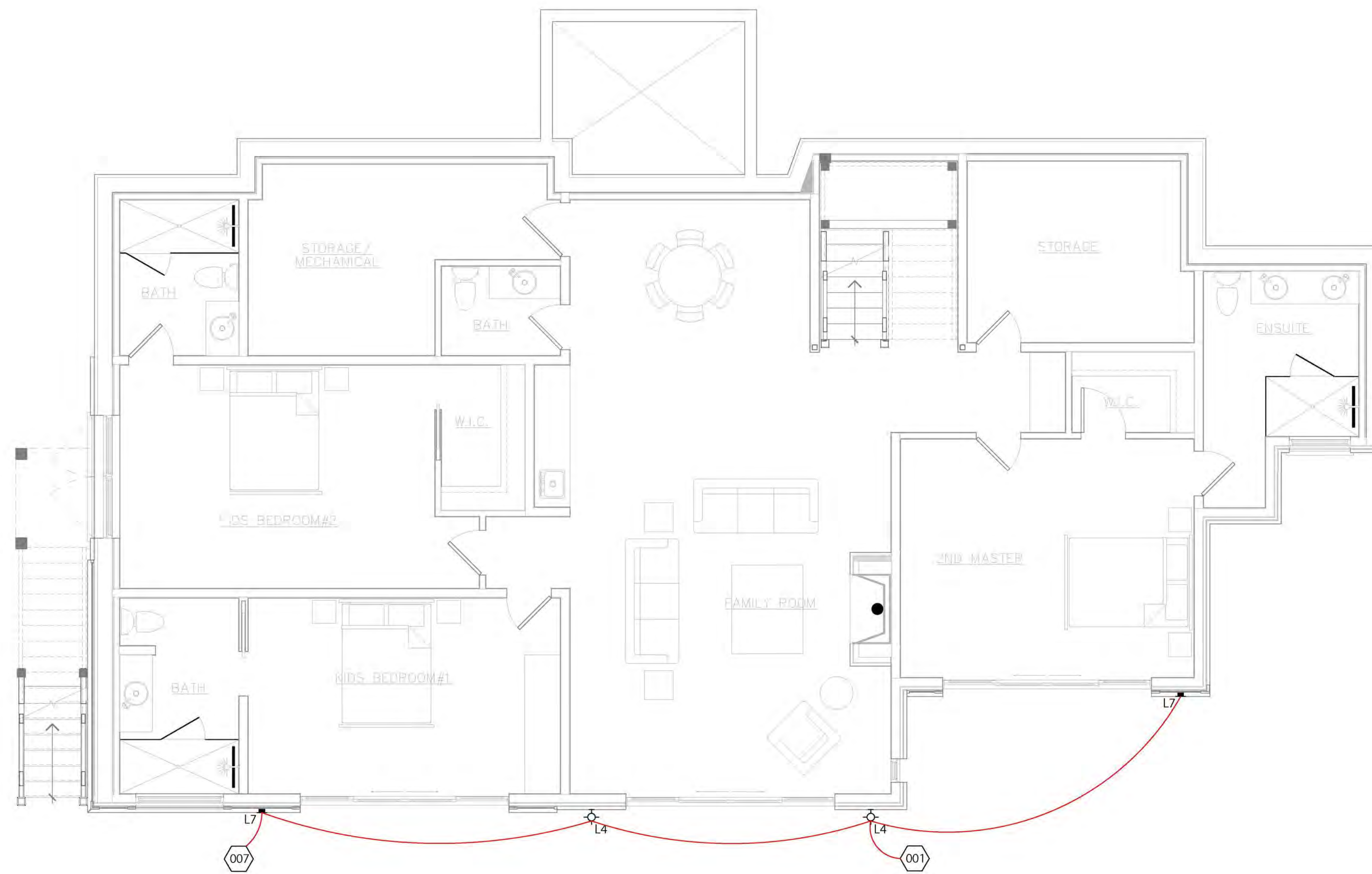

NOTES

1 CONTROL TYPE L8 - ADDRESS MONUMENT LIGHTING WITH ASTRONOMICAL TIME CLOCK.

2

3

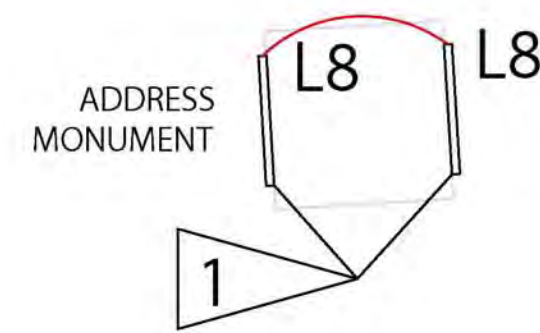

2 MAIN LEVEL - EXTERIOR ADDRESS MONUMENT
1/2" = 1'-0" (IMAGE NOT TO SCALE)

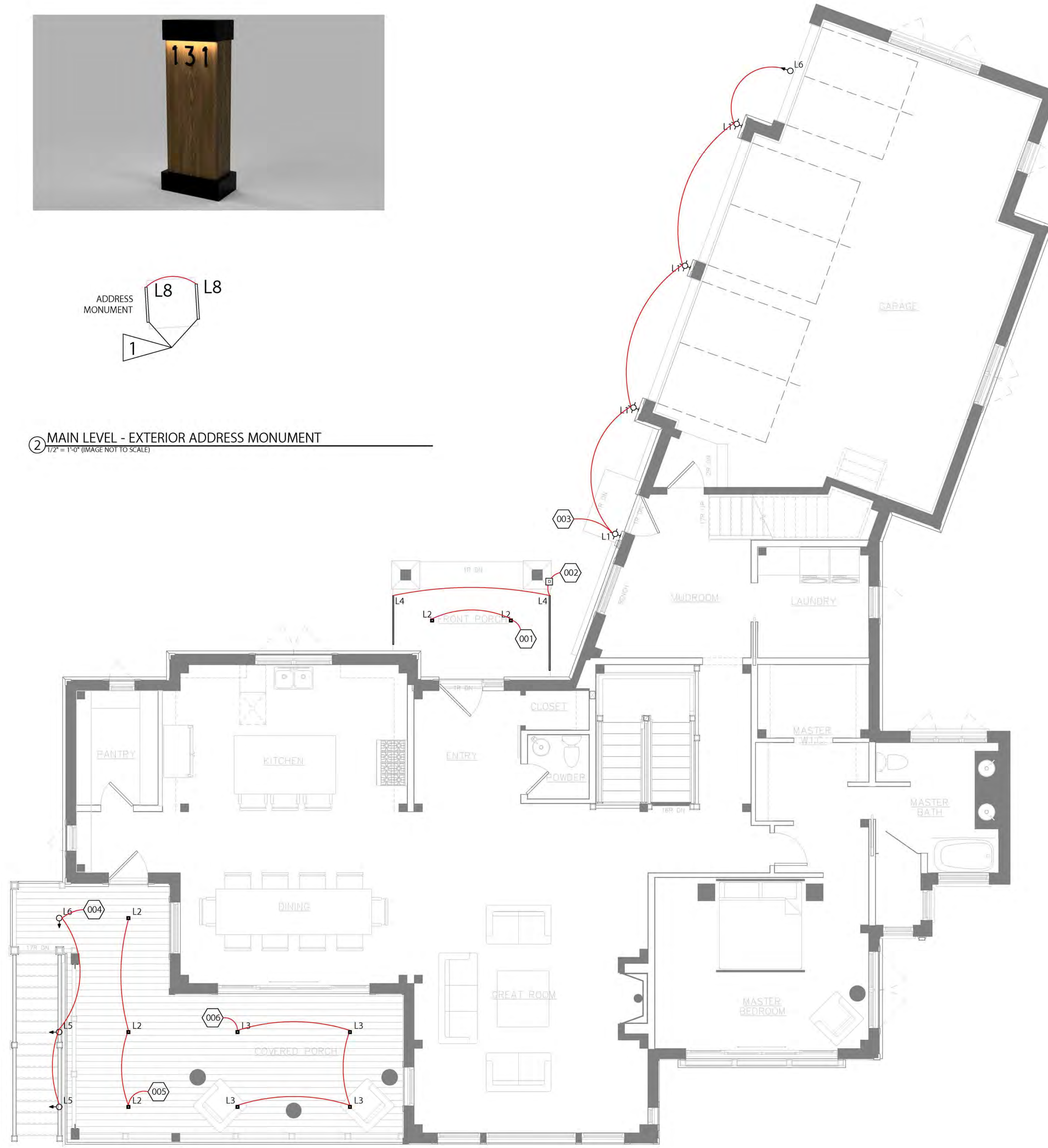

1 MAIN LEVEL - LIGHTING PLAN
1/4" = 1'-0"

CONSULTANTS

Architect
TBD

Interior Architect
TBD

Landscape Architect
TBD

General Contractor
TBD

Electrical Contractor
TBD

REVISIONS

DATE	DESCRIPTION
05.12.2021	DRB SUBMISSION

PROJECT

MOODY RESIDENCE
131 RUSSEL DRIVE
MOUNTAIN VILLAGE, CO 81435

SITE ORIENTATION

DRAWING TITLE





MAIN LEVEL
LIGHTING PLAN



DRAWING ISSUE

ISSUE	DRB SUBMISSION
DATE:	12 MAY 2021
DRAWING:	ARCH D - 24 X 36
SCALE:	AS NOTED ON DRAWING
JOB #:	NA
DRAWN BY:	AC
CHECKED BY:	CS

DRAWING NO.

L1.1

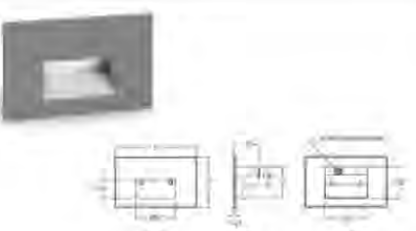
FXIT TYPE	IMAGE	DESCRIPTION	MANUFACTURER	MODEL	CATALOG NO	LAMP	LENGTH (FT.)	VOLTAGE	DIMMING	REMOTE / INTEGRAL POWER SUPPLY	ENERGY (W)	ENERGY (W/FT)	FINISH / IP RATING	DIMENSIONS	ACCESSORIES	NOTES	LOCATION
L1		Exterior Sconce Light	Kichler	Wesley	49278AZTLED	3000K, 8 Watts, 450 Lumens, 80 CRI	7"	120V	ELV	Line Voltage	8		Bronze/ Wet Location	7"W X 7.5"T X 4"D		Bronze, TBC	Exterior Sconce Lights
L2		3" Adjustable Recessed Downlight	Element	Entra	Housing: EN3S-L0927AA Trim: EN3S-LF-O-W	2700K, 980 Lumens, 12 Watts, 90 CRI Fixture to be dimmed to 25% at minimum to reduce lumen level to below 850 lumens.		120V-277V	Triac	Integral Power Supply	12.0		White / Damp Location	Housing: 7.3"W X 12.2"L X 3.5"T Trim: 3.5"W		Use 40 degree beam spread optic. White (to be painted onsite, color tbc), Flanged, Flat Trim.	Exterior Recessed Downlights
L3		3" Adjustable Recessed Downlight	Element	Entra	Housing: EN3S-L0927AA Trim: EN3S-LF-O-W	2700K, 980 Lumens, 12 Watts, 90 CRI Fixture to be dimmed to 25% at minimum to reduce lumen level to below 850 lumens.		120V-277V	Triac	Integral Power Supply	12.0		White / Damp Location	Housing: 7.3"W X 12.2"L X 3.5"T Trim: 3.5"W		Use 20 degree beam spread optic. White (to be painted onsite, color tbc), Flanged, Flat Trim.	Exterior Recessed Downlights
L4		3.0W Static White LED Linear	Qtran	TORO 12 Deg / SW24/3.0	Extrusion: TORO BK MG 40DEG XX LED: SW24/3.0WET 30 XX	2700K, 230 Lumens/ft, 3.0 Watts/ft, 96 CRI		24VDC	MLV	Remote Power Supply	3.0		Black / Wet Location	0.81"W X 0.98" T with magnet clip	Connectors: Provide PS to tape, jumper cables and end caps as required.	Toro Extrusion, 40 Degree Beam Spread	Exterior LED Linear Graze Lighting - Exterior Canopy Lighting
L5		LED Adjustable Cylinder	Besch Side Lighting	E16	E16_11WFL-2700K-BG3F-HL-CM-M1	2700K, 11W, 777 Lumens, 80+CRI		12V			11.0		TBD / Wet Location	2.4"W X 4.9"W		29 Degree Beam Spread	Exterior Surface Mount Adjustable Spot

FXIT TYPE	IMAGE	DESCRIPTION	MANUFACTURER	MODEL	CATALOG NO	LAMP	LENGTH (FT.)	VOLTAGE	DIMMING	REMOTE / INTEGRAL POWER SUPPLY	ENERGY (W)	ENERGY (W/FT)	FINISH / IP RATING	DIMENSIONS	ACCESSORIES	NOTES	LOCATION
L6		LED Adjustable Cylinder	Besch Side Lighting	E16	E16_11WFL-2700K-BG3F-HL-CM-M1 + HL1 (all) + QTY (1) RT - Rectilinear Spread Lens	2700K, 11W, 777 Lumens, 80+CRI		12V			11.0		TBD / Wet Location	2.4"W X 4.9"W		48 Degree Beam Spread	Exterior Surface Mount Adjustable Spot
L7		Interior Step Light	WAC Lighting	WL-LED100-C-BK	WL-LED100-C-BK	2700K, 3.9W, 30+ Lumens	5"	120V	ELV	Line Voltage	3.9W		TBD / IP66	5"W X 3"T X 0.1875"D		Black	Exterior Step Lights
L8		1.5W Static White LED Linear	Qtran	TORO 12 Deg / SW24/3.0	Extrusion: TORO BK MG 12DEG XX LED: SW24/1.5 WET 27 XX	2700K, 163 Lumens/ft, 1.5 Watts/ft, 96 CRI		24VDC	MLV	Remote Power Supply	3.0		Black / Wet Location	0.81"W X 0.98" T with magnet clip	Connectors: Provide PS to tape, jumper cables and end caps as required.	Toro Extrusion, 12 Degree Beam Spread	Exterior LED Linear Graze Lighting - Address Monument

NOTES

1) Electrical contractor to install and program lighting control system. EC to review utilize Control Overlay spreadsheet in initial programming of the system, and review final levels with lighting designer onsite during nighttime aiming sessions.

2)

GENERAL CONTROL SYSTEM NOTES:

QNTY OF KEYPADS (KP)	TYPES OF KP	BUTTON OPTIONS	COMMENTS	GENERAL NOTES:
				1. PROVIDE PRICING FOR LUTRON RADIO RA SYSTEM WITH SEE TOUCH DESIGNER KEYPADS.

01	CTF 6" HORIZONTAL SIDING
02	CTF 6" VERTICAL SIDING
03	STONE VENEER
04	CTF CEDAR WINDOW/DOOR TRIM
05	CTF EXTERIOR CORNER TRIM
06	CTF CEDAR BELLY BAND
07	CTF FASCIA
08	CTF TIMBERFRAME
09	ROOFING FINISH
10	METAL SILL/CAP FLASHING
11	PRECAST CAP

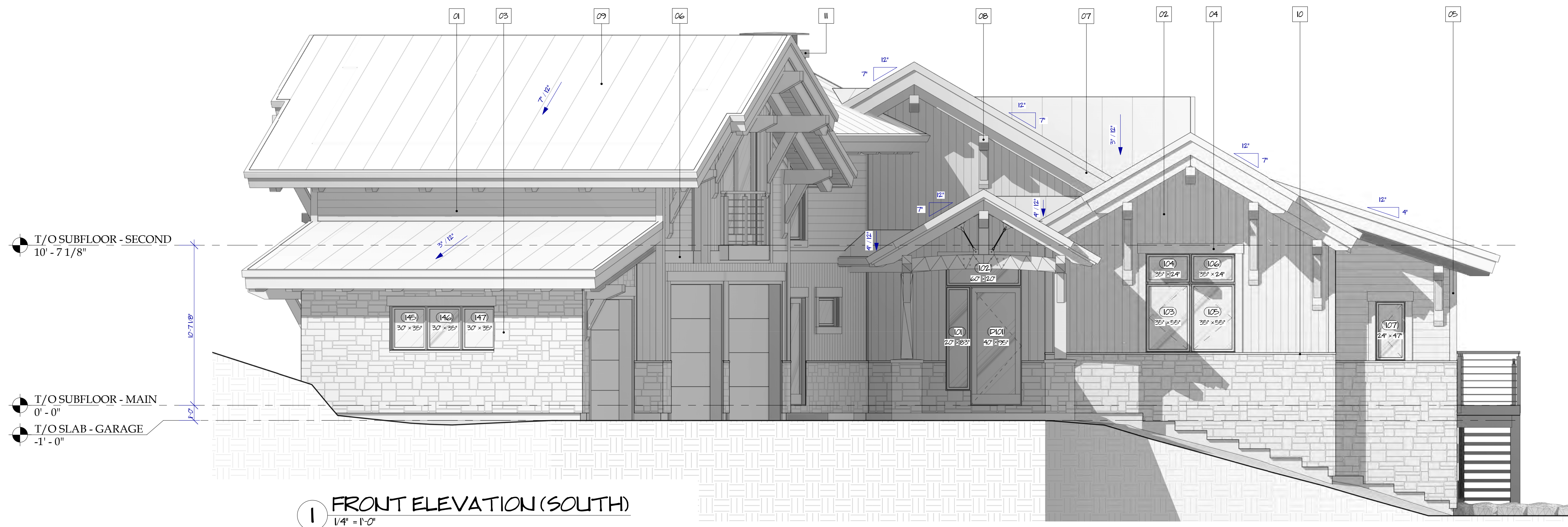

1 FRONT ELEVATION (SOUTH)
1/4" = 1'-0"

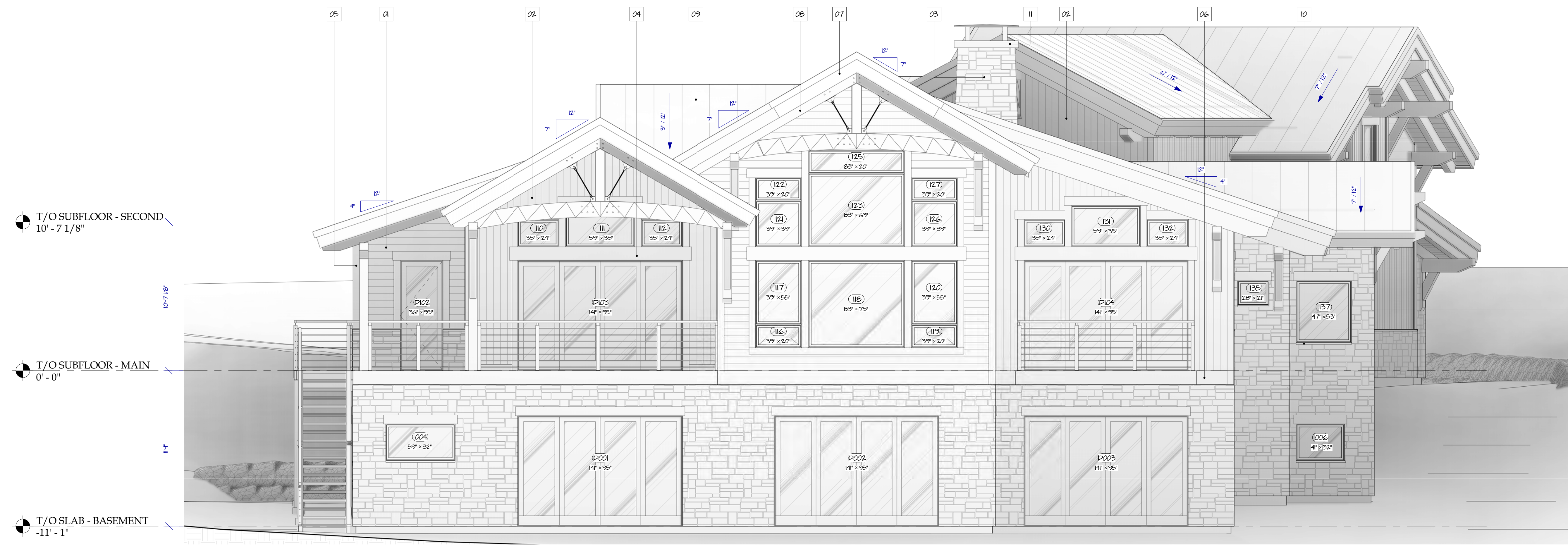

2 REAR ELEVATION (NORTH)
1/4" = 1'-0"



FRONT & REAR ELEVATIONS

P.O. BOX 1665
GOLDEN, BRITISH COLUMBIA, CANADA
V0A 1H0
OFFICE: (250) 348-2231
FAX: (250) 348-2241
WEB: WWW.CANADIANTIMBERFRAMES.COM

MOODY RESIDENCE
20130
2021-05-25 12:18:02 PM

ISSUED FOR: DRB REVIEW

THESE DRAWINGS ARE THE PROPERTY OF CANADIAN TIMBERFRAMES LTD. AND MAY NOT BE REPRODUCED OR COPIED WITHOUT OUR WRITTEN CONSENT. ALL DESIGNS, IDEAS, AND CONCEPTS DEVELOPED IN THIS DRAWING SHALL REMAIN AT ALL TIMES THE SOLE PROPERTY OF CANADIAN TIMBERFRAMES LTD.

01	CTF 6" HORIZONTAL SIDING
02	CTF 6" VERTICAL SIDING
03	STONE VENEER
04	CTF CEDAR WINDOW/DOOR TRIM
05	CTF EXTERIOR CORNER TRIM
06	CTF CEDAR BELLY BAND
07	CTF FASCIA
08	CTF TIMBERFRAME
09	ROOFING FINISH
10	METAL SILL/CAP FLASHING
11	PRECAST CAP

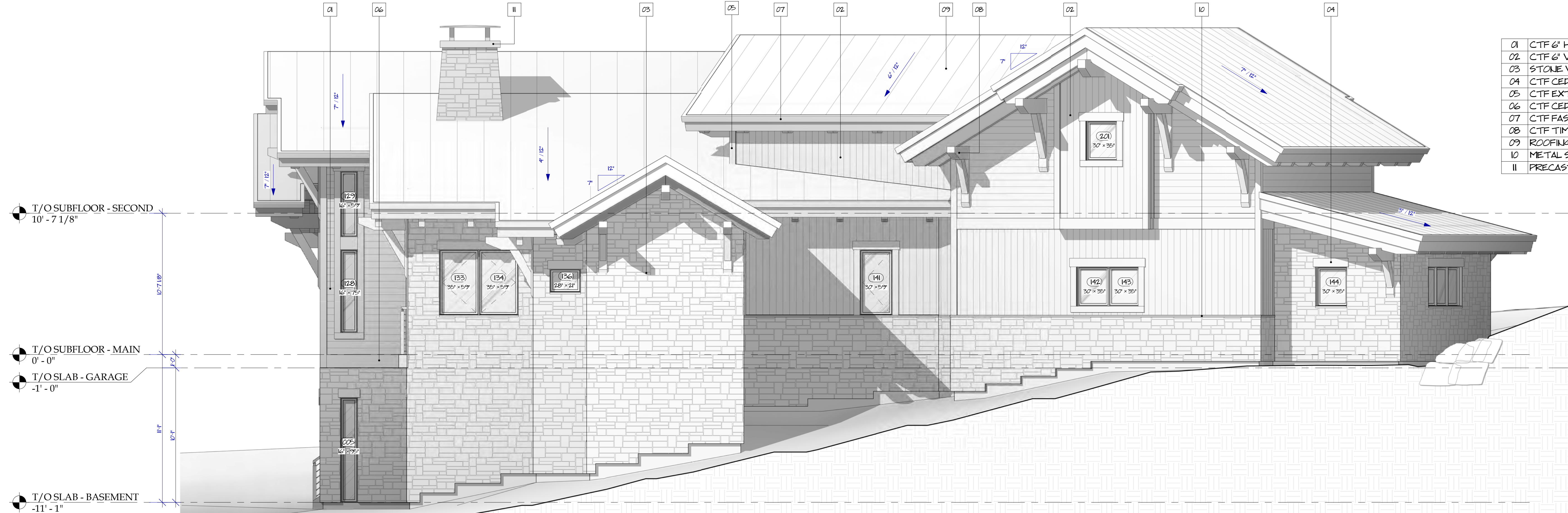

1 LEFT SIDE ELEVATION (WEST)
1/4" = 1'-0"

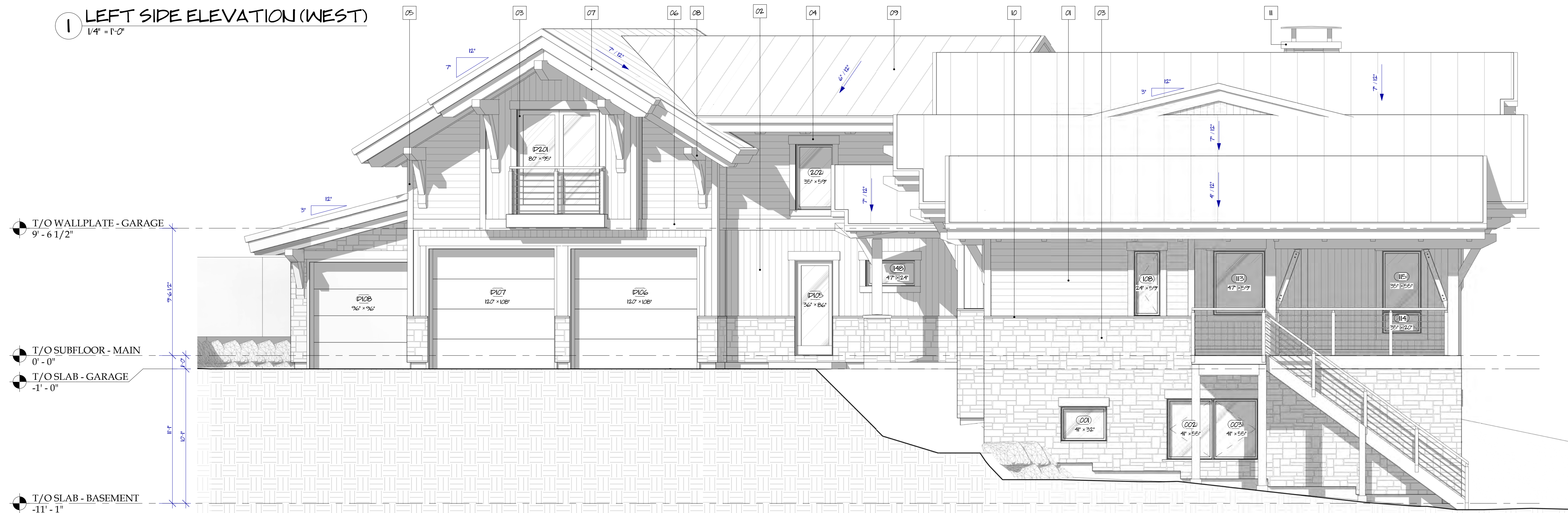

2 RIGHT SIDE ELEVATION (EAST)
1/4" = 1'-0"

SIDE ELEVATIONS



P.O. BOX 1665
GOLDEN, BRITISH COLUMBIA, CANADA
V0A 1H0
OFFICE: (250) 348-2231
FAX: (250) 348-2241
WEB: WWW.CANADIANTIMBERFRAMES.COM

MOODY RESIDENCE
20130
2021-05-25 12:18:39 PM

ISSUED FOR: DRB REVIEW

THESE DRAWINGS ARE THE PROPERTY OF CANADIAN TIMBERFRAMES LTD. AND MAY NOT BE REPRODUCED OR COPIED WITHOUT OUR WRITTEN CONSENT. ALL DESIGNS, IDEAS, AND CONCEPTS DEVELOPED IN THIS DRAWING SHALL REMAIN AT ALL TIMES THE SOLE PROPERTY OF CANADIAN TIMBERFRAMES LTD.

A-3.2

01	CTF 6" HORIZONTAL SIDING
02	CTF 6" VERTICAL SIDING
03	STONE VENEER
04	CTF CEDAR WINDOW/DOOR TRIM
05	CTF EXTERIOR CORNER TRIM
06	CTF CEDAR BELLY BAND
07	CTF FASCIA
08	CTF TIMBERFRAME
09	ROOFING FINISH
10	METAL SILL/CAP FLASHING
11	PRECAST CAP

1 I/O SUBFLOOR - SECOND
10' - 71/8"

1 I/O SUBFLOOR - MAIN
0' - 0"

1 I/O SLAB - GARAGE
-1' - 0"

1 I/O SLAB - BASEMENT
-11' - 1"

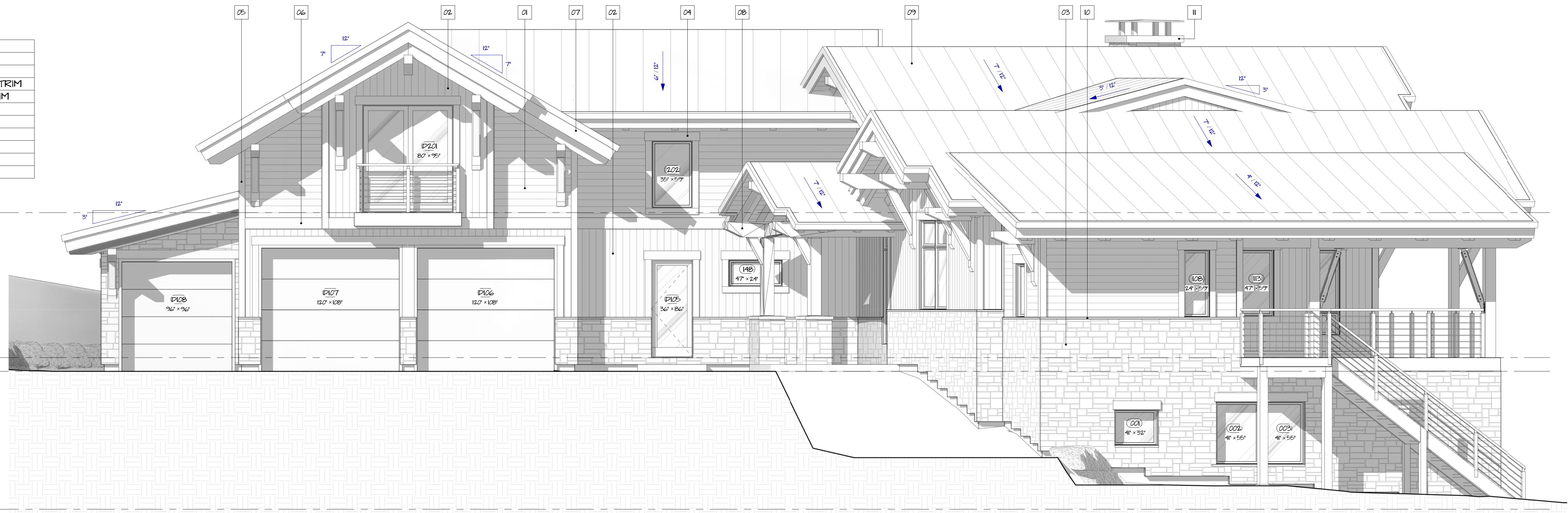

1 GARAGE FRONT ELEVATION (SOUTH EAST)
1/4" = 1'-0"

1 I/O SUBFLOOR - SECOND
10' - 71/8"

1 I/O SUBFLOOR - MAIN
0' - 0"

1 I/O SLAB - GARAGE
-1' - 0"

1 I/O SLAB - BASEMENT
-11' - 1"

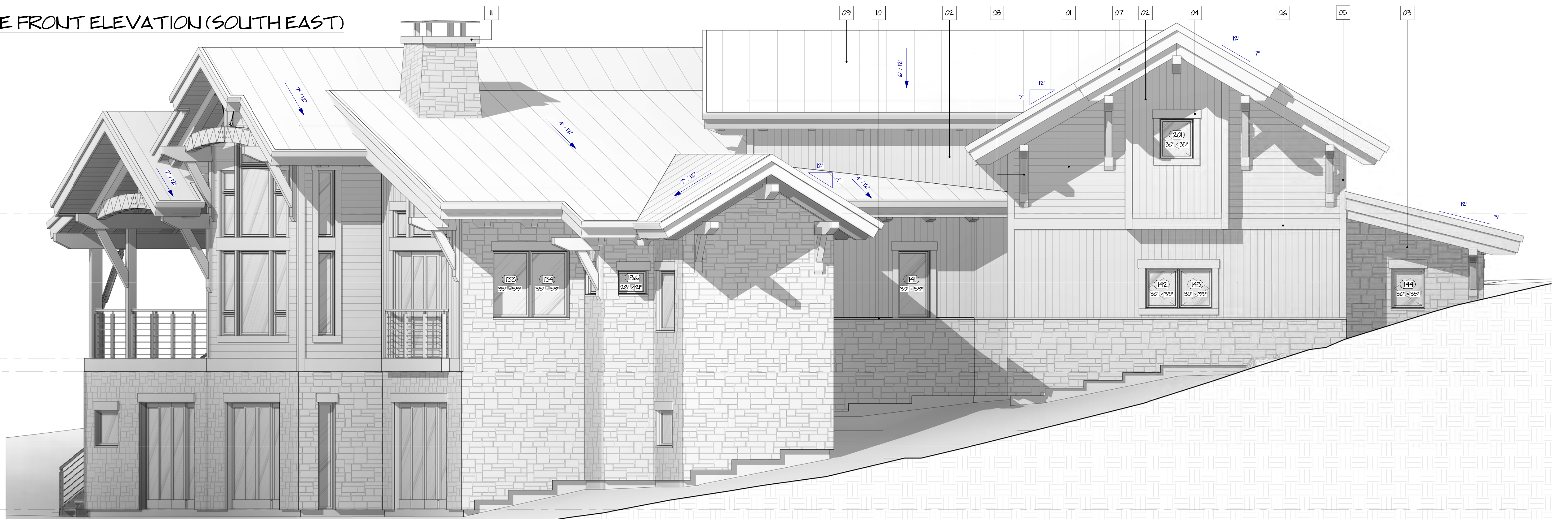

2 GARAGE REAR ELEVATION (NORTH WEST)
1/4" = 1'-0"



GARAGE FRONT & REAR ELEVATIONS

P.O. BOX 1665
GOLDEN, BRITISH COLUMBIA, CANADA
V0A 1H0
OFFICE: (250) 348-2231
FAX: (250) 348-2241
WEB: WWW.CANADIANTIMBERFRAMES.COM

MOODY RESIDENCE
20130
2021-05-25 12:19:22 PM

ISSUED FOR: DRB REVIEW

THESE DRAWINGS ARE THE PROPERTY OF CANADIAN TIMBERFRAMES LTD. AND MAY NOT BE REPRODUCED OR COPIED WITHOUT OUR WRITTEN CONSENT. ALL DESIGNS, IDEAS, AND CONCEPTS DEVELOPED IN THIS DRAWING SHALL REMAIN AT ALL TIMES THE SOLE PROPERTY OF CANADIAN TIMBERFRAMES LTD.

01	CTF 6" HORIZONTAL SIDING
02	CTF 6" VERTICAL SIDING
03	STONE VENEER
04	CTF CEDAR WINDOW/DOOR TRIM
05	CTF EXTERIOR CORNER TRIM
06	CTF CEDAR BELLY BAND
07	CTF FASCIA
08	CTF TIMBERFRAME
09	ROOFING FINISH
10	METAL SILL/CAP FLASHING
11	PRECAST CAP

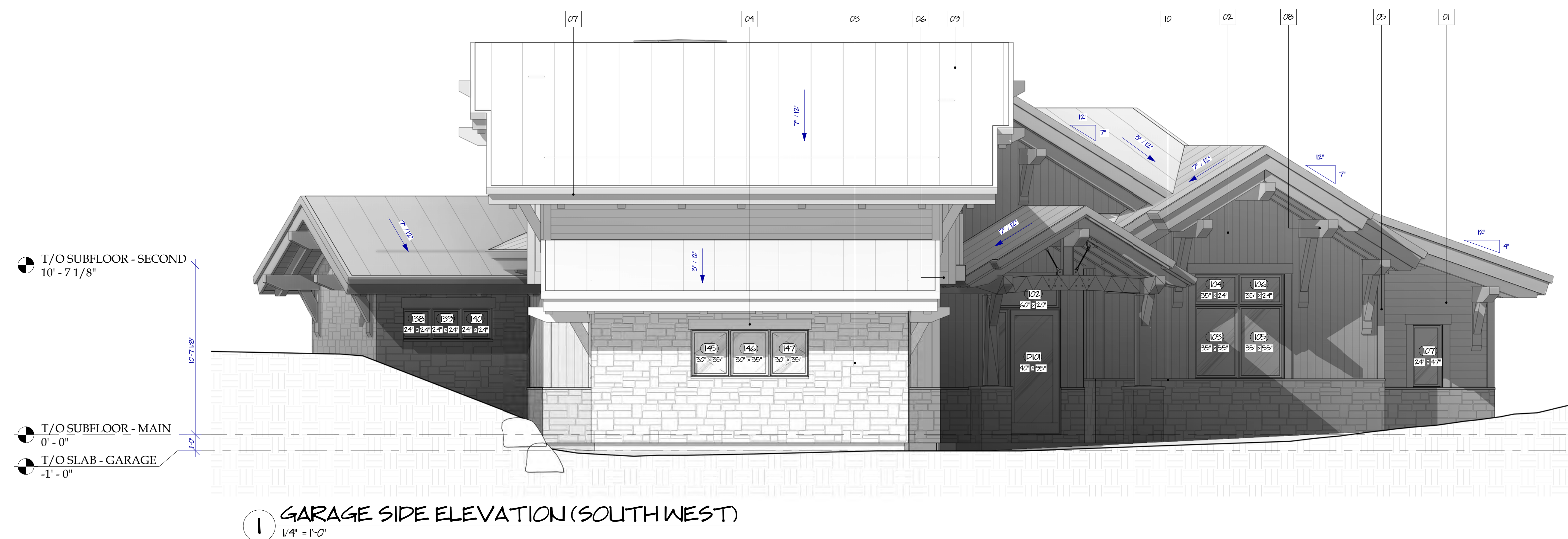

P.O. BOX 1665
GOLDEN, BRITISH COLUMBIA, CANADA
V0A 1H0

OFFICE: (250) 348-2231
FAX: (250) 348-2241
WEB: WWW.CANADIANTIMBERFRAMES.COM

GARAGE SIDE ELEVATION

MOODY RESIDENCE
20130
2021-05-25 12:19:37 PM

ISSUED FOR: DRB REVIEW

THESE DRAWINGS ARE THE PROPERTY OF CANADIAN TIMBERFRAMES LTD. AND MAY NOT BE REPRODUCED OR COPIED WITHOUT OUR WRITTEN CONSENT. ALL DESIGNS, IDEAS, AND CONCEPTS DEVELOPED IN THIS DRAWING SHALL REMAIN AT ALL TIMES THE SOLE PROPERTY OF CANADIAN TIMBERFRAMES LTD.

A-3.4

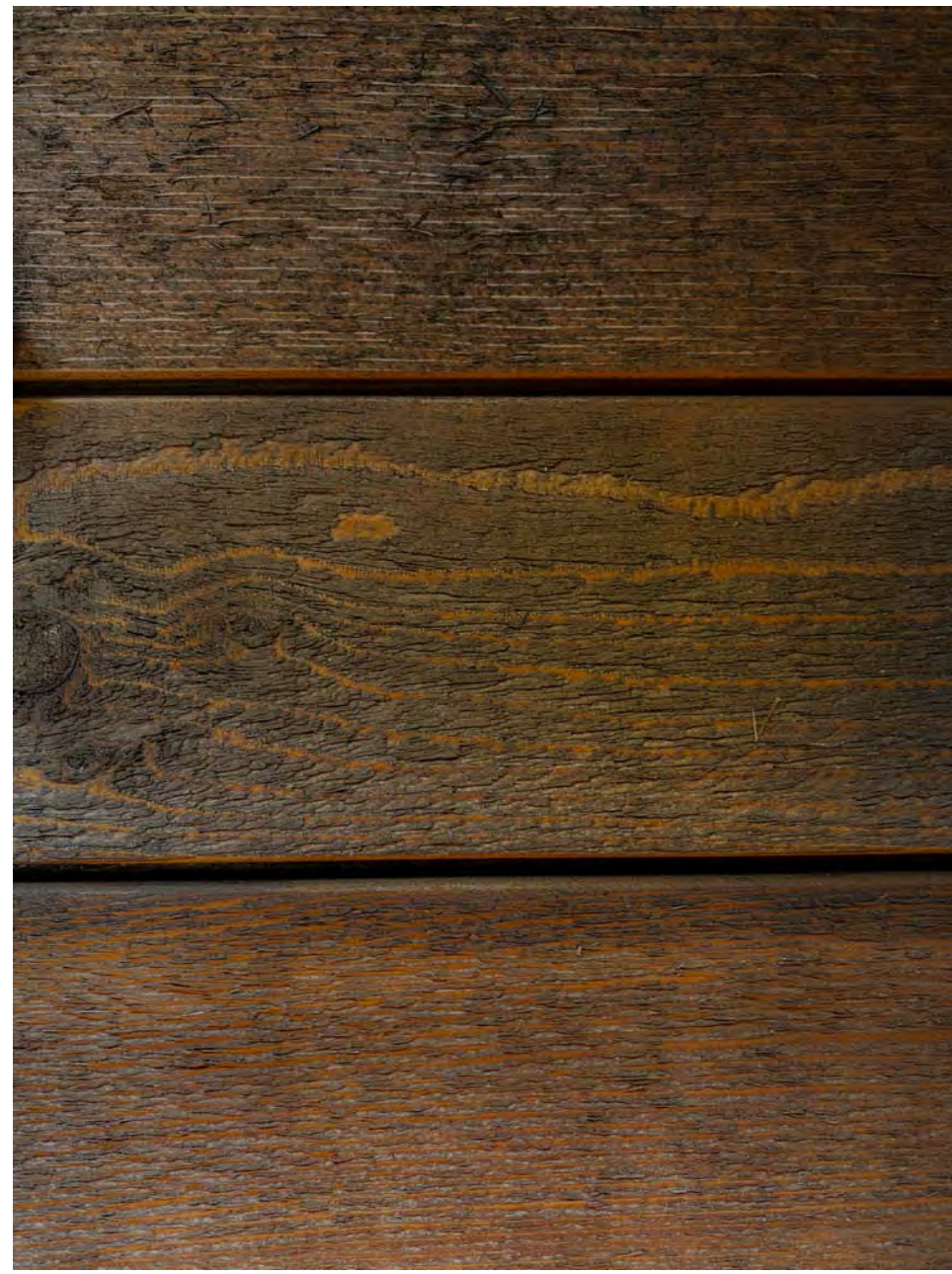

CTF 6" HORIZONTAL SIDING
COLOR - ACORN 25



CTF 6" VERTICAL SIDING
COLOR - ACORN 25



STONE VENEER - TELLURIDE STONE
COMPANY
COLOR - SAGE LEDGESTONE



CTF CEDAR TRIM & FASCIA
COLOR - ACORN 25



CTF DOUGLAS FIR T&G SOFFIT
COLOR - RUSSET BROWN

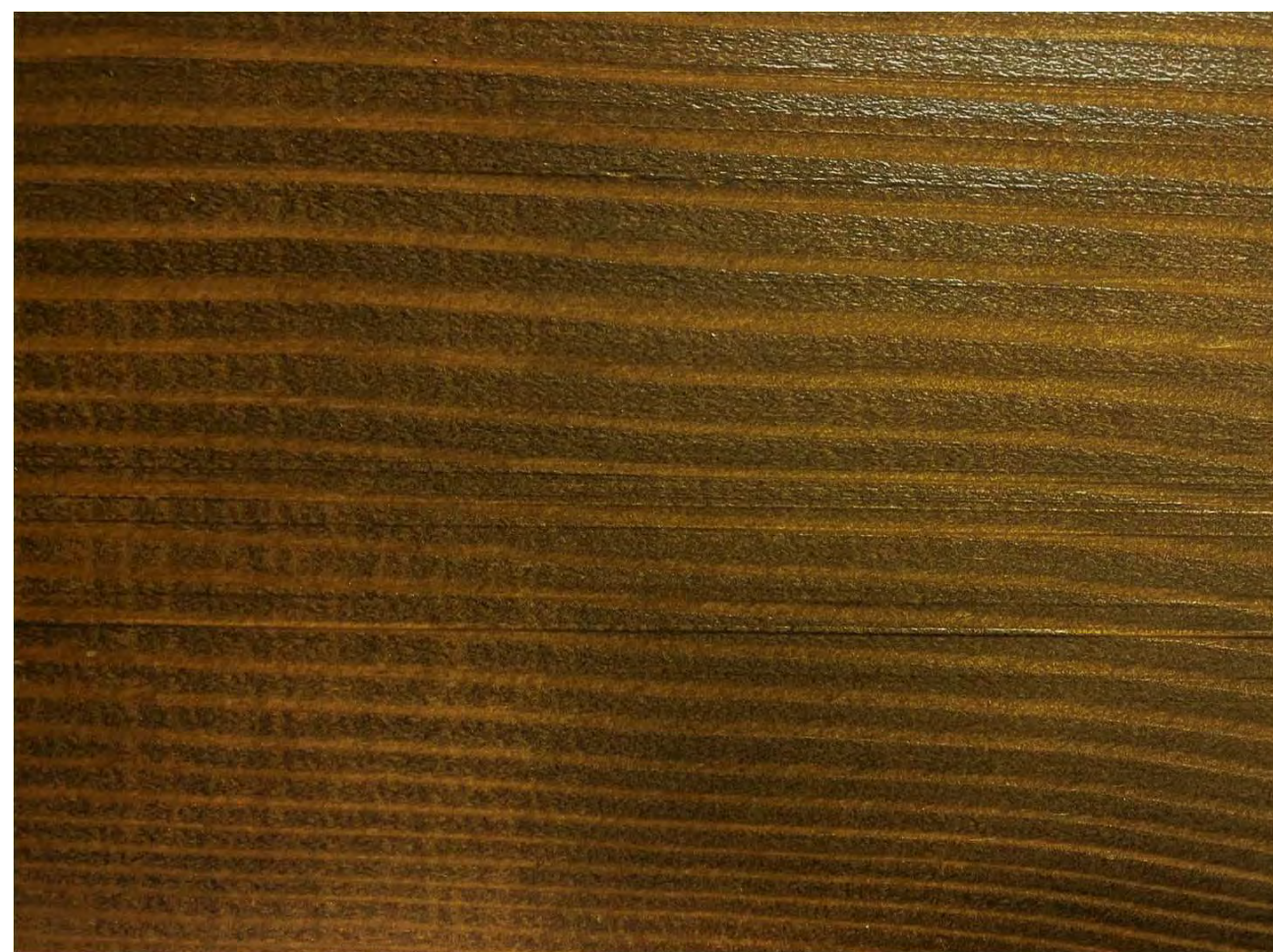

CTF TIMBERFRAME
COLOR - SANSIN TEAK TRIPPLE TINT
(#2021-004)



CTF TIMBERFRAME ACCENT METAL
COLOR - SOLAR BLACK (044/80060)

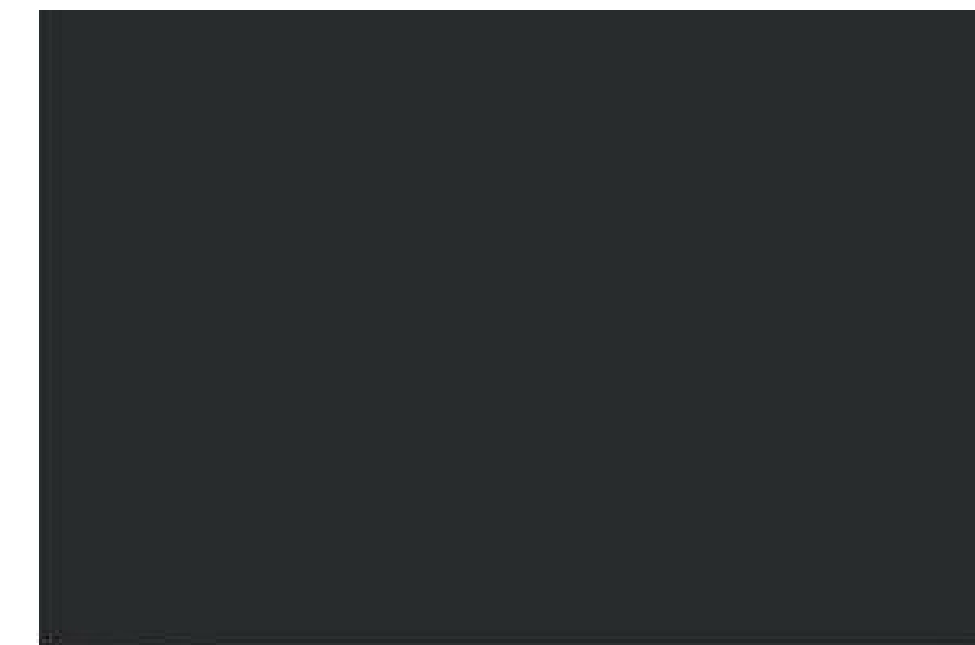

ROOFING FINISH - BERRIGATE
MANUFACTURING COMPANY
COLOR - MATTE BLACK

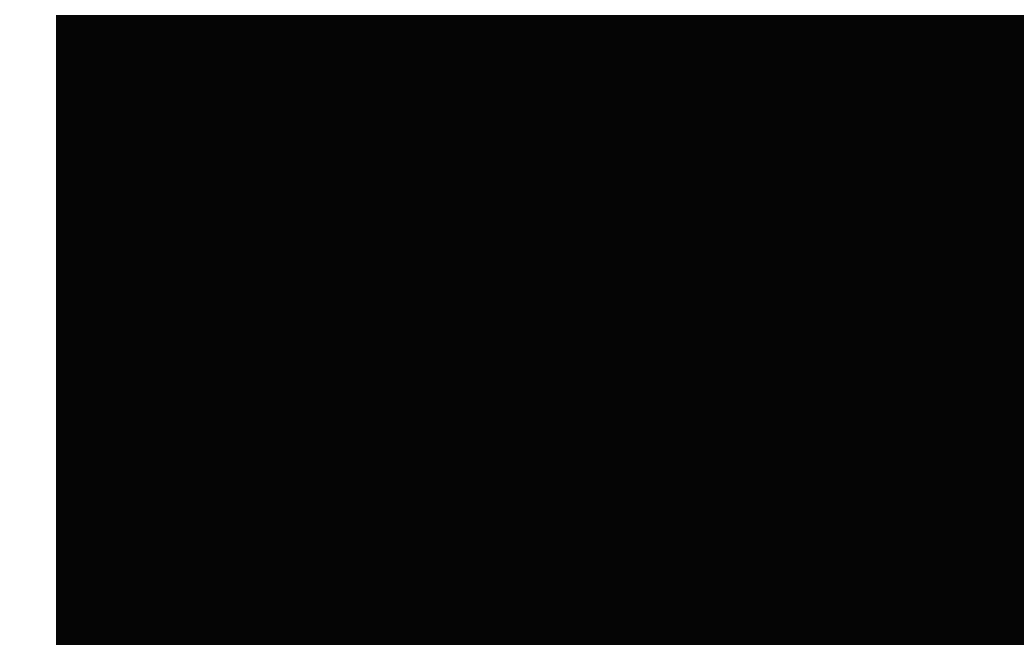

WINDOW/DOOR FRAME
COLOR - LOEWEN STEEL MATTE BLACK



P.O. BOX 1665
GOLDEN, BRITISH COLUMBIA, CANADA
V0A 1H0

OFFICE: (250) 348-2231
FAX: (250) 348-2241
WEB: WWW.CANADIANTIMBERFRAMES.COM

MATERIAL & COLOR SAMPLE BOARD

MOODY RESIDENCE
20130
2021-05-25 12:19:39 PM

ISSUED FOR: DRB REVIEW

THESE DRAWINGS ARE THE PROPERTY OF CANADIAN TIMBERFRAMES LTD. AND MAY NOT BE REPRODUCED OR COPIED WITHOUT OUR WRITTEN CONSENT. ALL DESIGNS, IDEAS, AND CONCEPTS DEVELOPED IN THIS DRAWING SHALL REMAIN AT ALL TIMES THE SOLE PROPERTY OF CANADIAN TIMBERFRAMES LTD.



METAL GARAGE DOOR STYLE
COLOR - STEEL MATTE BLACK



EXTERIOR METAL RAILING STYLE
COLOR - MATTE BLACK

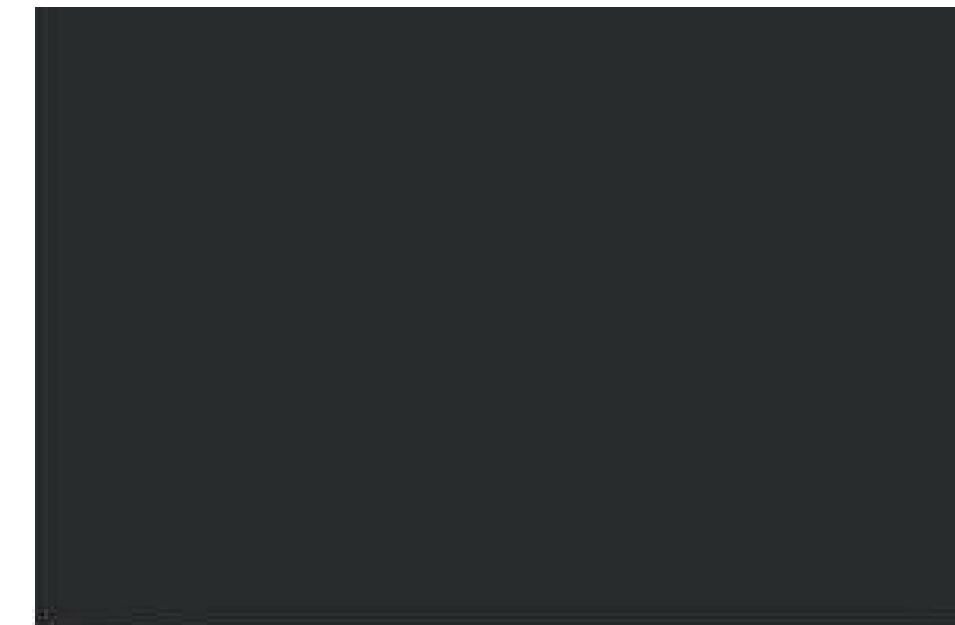

UPPER METAL CHIMNEY CAP
COLOR - BERRIGATE MATTE BLACK



LOWER PRECAST CHIMNEY CAP
MATERIAL - PRECAST CONCRETE



METAL SILL/CAP FLASHING
COLOR - STEEL MATTE BLACK



P.O. BOX 1665
GOLDEN, BRITISH COLUMBIA, CANADA
V0A 1H0
OFFICE: (250) 348-2231
FAX: (250) 348-2241
WEB: WWW.CANADIANTIMBERFRAMES.COM

MATERIAL & COLOR SAMPLE BOARD

MOODY RESIDENCE
20130
2021-05-25 12:19:40 PM

ISSUED FOR: DRB REVIEW

THESE DRAWINGS ARE THE PROPERTY OF CANADIAN TIMBERFRAMES LTD. AND MAY NOT BE REPRODUCED OR COPIED WITHOUT OUR WRITTEN CONSENT. ALL DESIGNS, IDEAS, AND CONCEPTS DEVELOPED IN THIS DRAWING SHALL REMAIN AT ALL TIMES THE SOLE PROPERTY OF CANADIAN TIMBERFRAMES LTD.



NORTH PERSPECTIVE

P.O. BOX 1665
GOLDEN, BRITISH COLUMBIA, CANADA
V0A 1H0

OFFICE: (250) 348-2231
FAX: (250) 348-2241
WEB: WWW.CANADIANTIMBERFRAMES.COM

MOODY RESIDENCE
20130
2021-05-25 12:23:34 PM

ISSUED FOR: DRB REVIEW

THESE DRAWINGS ARE THE PROPERTY OF CANADIAN TIMBERFRAMES LTD. AND MAY NOT BE REPRODUCED OR COPIED WITHOUT OUR WRITTEN CONSENT. ALL DESIGNS, IDEAS, AND CONCEPTS DEVELOPED IN THIS DRAWING SHALL REMAIN AT ALL TIMES THE SOLE PROPERTY OF CANADIAN TIMBERFRAMES LTD.

A-4.1



P.O. BOX 1665
GOLDEN, BRITISH COLUMBIA, CANADA
V0A 1H0

OFFICE: (250) 348-2231
FAX: (250) 348-2241
WEB: WWW.CANADIANTIMBERFRAMES.COM

SOUTH PERSPECTIVE

MOODY RESIDENCE
20130
2021-05-25 12:26:43 PM

ISSUED FOR: DRB REVIEW

THESE DRAWINGS ARE THE PROPERTY OF CANADIAN TIMBERFRAMES LTD. AND MAY NOT BE REPRODUCED OR COPIED WITHOUT OUR WRITTEN CONSENT. ALL DESIGNS, IDEAS, AND CONCEPTS DEVELOPED IN THIS DRAWING SHALL REMAIN AT ALL TIMES THE SOLE PROPERTY OF CANADIAN TIMBERFRAMES LTD.

A-4.2



EAST PERSPECTIVE

P.O. BOX 1665
GOLDEN, BRITISH COLUMBIA, CANADA
V0A 1H0
OFFICE: (250) 348-2231
FAX: (250) 348-2241
WEB: WWW.CANADIANTIMBERFRAMES.COM

MOODY RESIDENCE
20130
2021-05-25 12:29:58 PM

ISSUED FOR: DRB REVIEW

THESE DRAWINGS ARE THE PROPERTY OF CANADIAN TIMBERFRAMES LTD. AND MAY NOT BE REPRODUCED OR COPIED WITHOUT OUR WRITTEN CONSENT. ALL DESIGNS, IDEAS, AND CONCEPTS DEVELOPED IN THIS DRAWING SHALL REMAIN AT ALL TIMES THE SOLE PROPERTY OF CANADIAN TIMBERFRAMES LTD.

A-4.3



P.O. BOX 1665
GOLDEN, BRITISH COLUMBIA, CANADA
V0A 1H0

OFFICE: (250) 348-2231
FAX: (250) 348-2241
WEB: WWW.CANADIANTIMBERFRAMES.COM

WEST PERSPECTIVE

MOODY RESIDENCE
20130
2021-05-25 12:33:45 PM

ISSUED FOR: DRB REVIEW

THESE DRAWINGS ARE THE PROPERTY OF CANADIAN TIMBERFRAMES LTD. AND MAY NOT BE REPRODUCED OR COPIED WITHOUT OUR WRITTEN CONSENT. ALL DESIGNS, IDEAS, AND CONCEPTS DEVELOPED IN THIS DRAWING SHALL REMAIN AT ALL TIMES THE SOLE PROPERTY OF CANADIAN TIMBERFRAMES LTD.

A-4.4



P.O. BOX 1665
GOLDEN, BRITISH COLUMBIA, CANADA
V0A 1H0

OFFICE: (250) 348-2231
FAX: (250) 348-2241
WEB: WWW.CANADIANTIMBERFRAMES.COM

SOUTH EAST PERSPECTIVE

MOODY RESIDENCE
20130
2021-05-25 12:36:27 PM

ISSUED FOR: DRB REVIEW

THESE DRAWINGS ARE THE PROPERTY OF CANADIAN TIMBERFRAMES LTD. AND MAY NOT BE REPRODUCED OR COPIED WITHOUT OUR WRITTEN CONSENT. ALL DESIGNS, IDEAS, AND CONCEPTS DEVELOPED IN THIS DRAWING SHALL REMAIN AT ALL TIMES THE SOLE PROPERTY OF CANADIAN TIMBERFRAMES LTD.

A-4.5



SOUTH WEST PERSPECTIVE

P.O. BOX 1665
GOLDEN, BRITISH COLUMBIA, CANADA
V0A 1H0

OFFICE: (250) 348-2231
FAX: (250) 348-2241
WEB: WWW.CANADIANTIMBERFRAMES.COM

MOODY RESIDENCE
20130
2021-05-25 12:39:59 PM

ISSUED FOR: DRB REVIEW

THESE DRAWINGS ARE THE PROPERTY OF CANADIAN TIMBERFRAMES LTD. AND MAY NOT BE REPRODUCED OR COPIED WITHOUT OUR WRITTEN CONSENT. ALL DESIGNS, IDEAS, AND CONCEPTS DEVELOPED IN THIS DRAWING SHALL REMAIN AT ALL TIMES THE SOLE PROPERTY OF CANADIAN TIMBERFRAMES LTD.

A-4.6



NORTH EAST PERSPECTIVE

P.O. BOX 1665
GOLDEN, BRITISH COLUMBIA, CANADA
V0A 1H0

OFFICE: (250) 348-2231
FAX: (250) 348-2241
WEB: WWW.CANADIANTIMBERFRAMES.COM

MOODY RESIDENCE
20130
2021-05-25 12:43:53 PM

ISSUED FOR: DRB REVIEW

THESE DRAWINGS ARE THE PROPERTY OF CANADIAN TIMBERFRAMES LTD. AND MAY NOT BE REPRODUCED OR COPIED WITHOUT OUR WRITTEN CONSENT. ALL DESIGNS, IDEAS, AND CONCEPTS DEVELOPED IN THIS DRAWING SHALL REMAIN AT ALL TIMES THE SOLE PROPERTY OF CANADIAN TIMBERFRAMES LTD.

A-4.7



NORTH WEST PERSPECTIVE

P.O. BOX 1665
GOLDEN, BRITISH COLUMBIA, CANADA
V0A 1H0
OFFICE: (250) 348-2231
FAX: (250) 348-2241
WEB: WWW.CANADIANTIMBERFRAMES.COM

MOODY RESIDENCE
20130
2021-05-25 12:47:14 PM

ISSUED FOR: DRB REVIEW

THESE DRAWINGS ARE THE PROPERTY OF CANADIAN TIMBERFRAMES LTD. AND MAY NOT BE REPRODUCED OR COPIED WITHOUT OUR WRITTEN CONSENT. ALL DESIGNS, IDEAS, AND CONCEPTS DEVELOPED IN THIS DRAWING SHALL REMAIN AT ALL TIMES THE SOLE PROPERTY OF CANADIAN TIMBERFRAMES LTD.

A-4.8

BUILDING PERIMETER INTERVAL LENGTH = 19'-5 3/4"	ELEV.	BUILDING PERIMETER INTERVAL	AVERAGE HEIGHT (FEET)	AVERAGE BUILDING HEIGHT (MAX. 30')	BUILDING HEIGHT (MAX. 40')
1		1	20.97	26.02	
		2	23.80	28.85	27.93
		3	28.71	32.31	
2		4	27.45	31.65	
		5	26.18	28.85	31.54
3		6	27.39	31.81	
		7	28.84	33.26	34.21
		8	26.19	30.04	
4		9	30.86	35.18	
		10	31.43	35.75	35.37
		11	27.87	30.61	
5		12	25.26	30.65	
		13	23.57	28.96	32.73
		14	26.89	30.50	
6		15	23.42	28.47	
		16	19.36	24.41	26.85
7		17	20.61	25.66	

AVERAGE HEIGHT = **25.81**
 AVERAGE BUILDING HEIGHT = **30.18**
 BUILDING HEIGHT = **35.37**

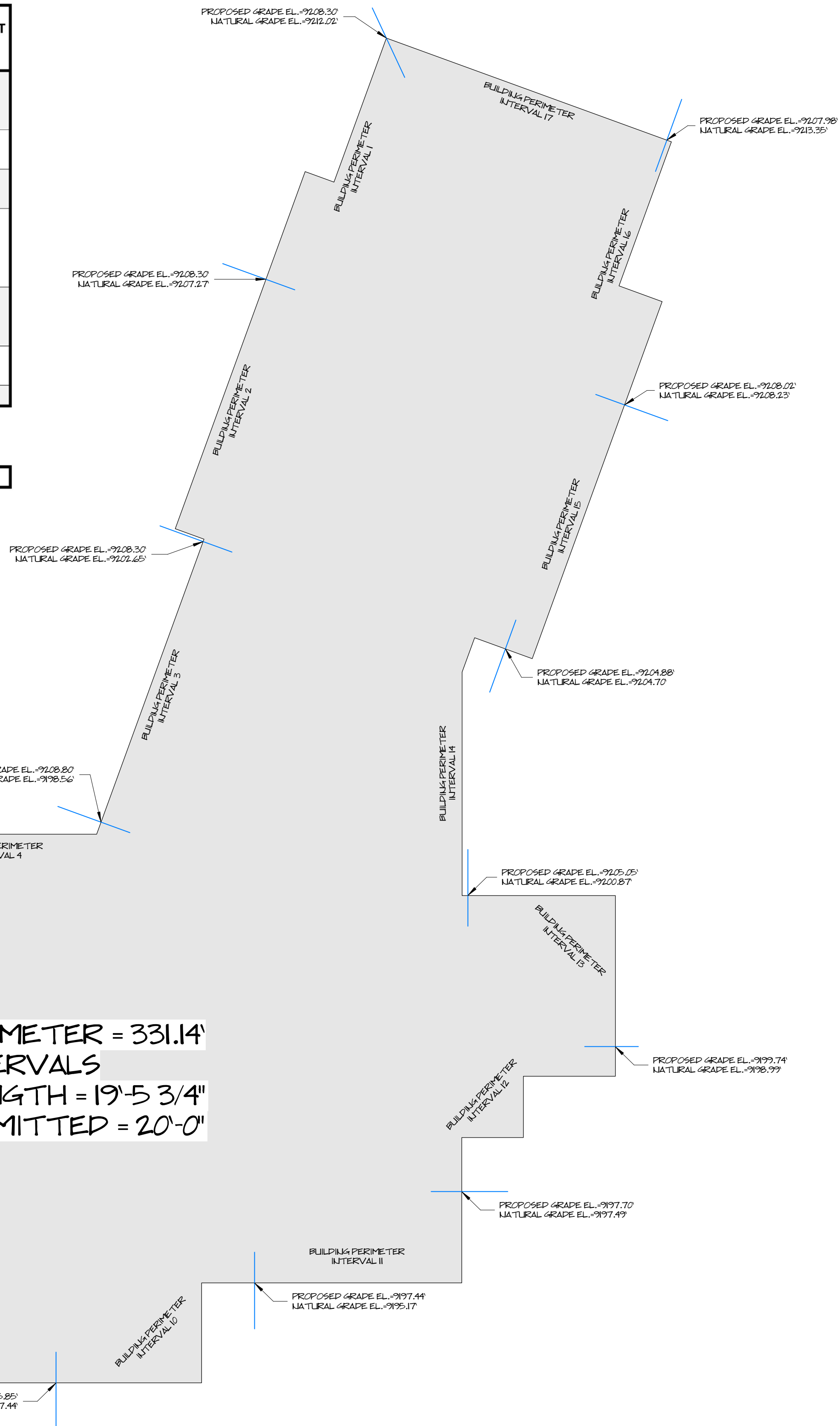

BUILDING PERIMETER = 331.14'
 17 INTERVALS
 INTERVAL LENGTH = 19'-5 3/4"
 MAXIMUM PERMITTED = 20'-0"

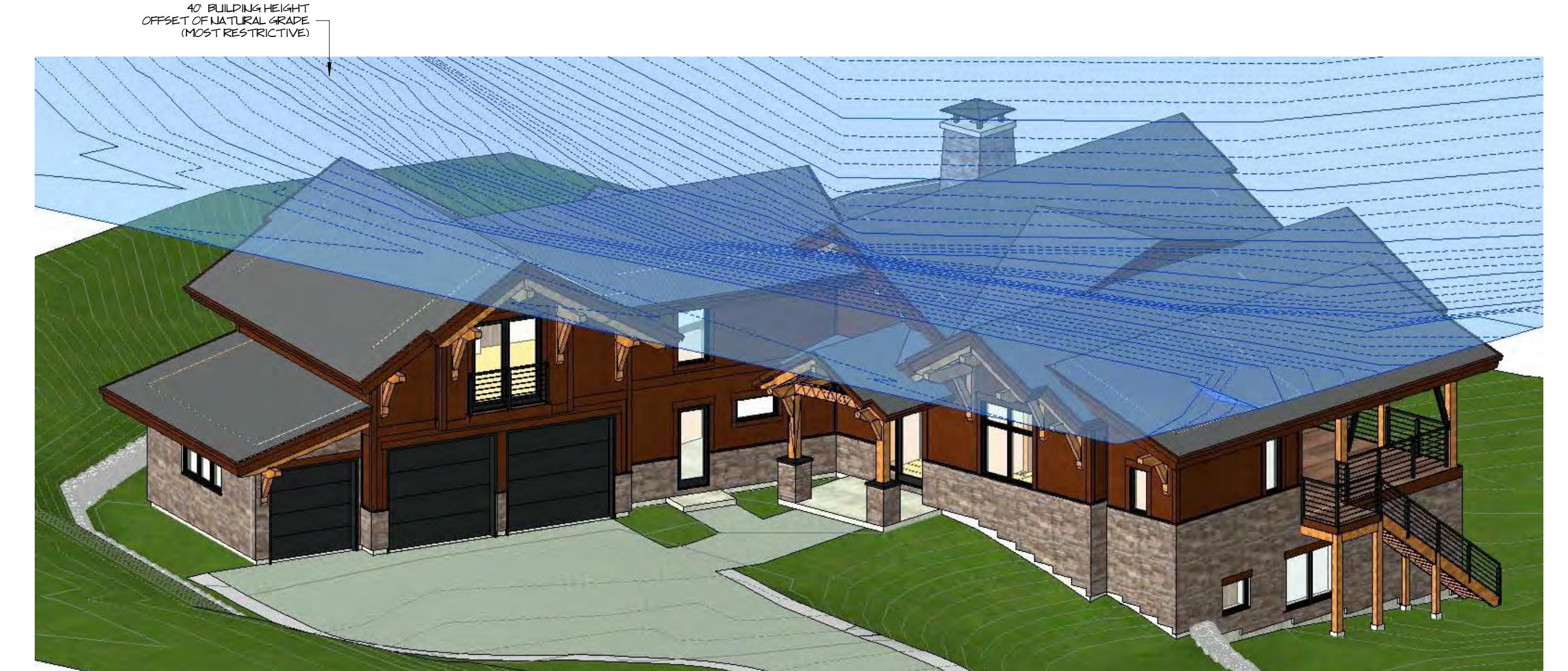
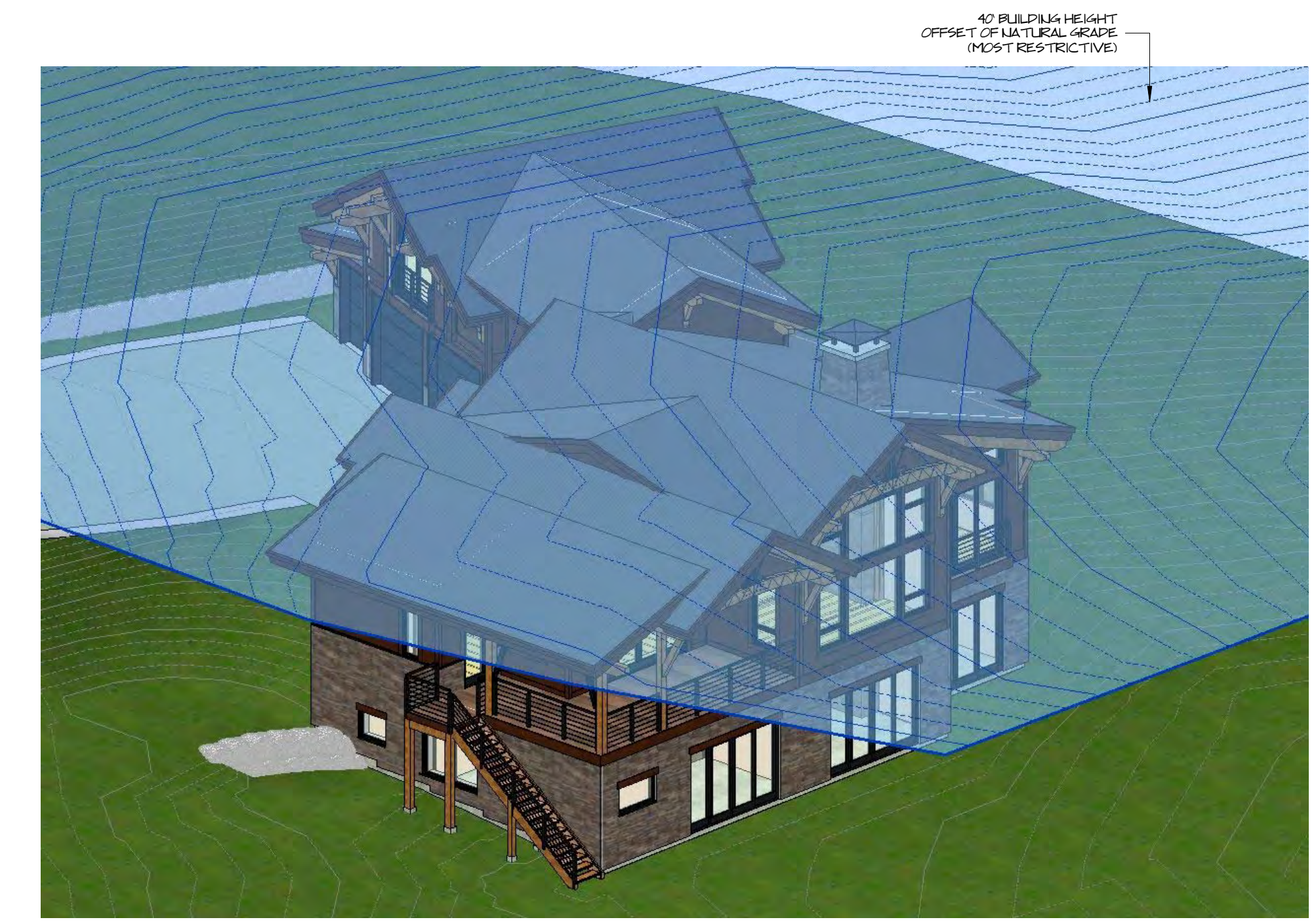

BUILDING HEIGHT PERIMETER INTERVAL PLAN

P.O. BOX 1665
 GOLDEN, BRITISH COLUMBIA, CANADA
 V0A 1H0
 OFFICE: (250) 348-2231
 FAX: (250) 348-2241
 WEB: WWW.CANADIANTIMBERFRAMES.COM

MOODY RESIDENCE
 20130
 2021-05-25 12:47:15 PM

ISSUED FOR: DRB REVIEW

THESE DRAWINGS ARE THE PROPERTY OF CANADIAN TIMBERFRAMES LTD. AND MAY NOT BE REPRODUCED OR COPIED WITHOUT OUR WRITTEN CONSENT. ALL DESIGNS, IDEAS, AND CONCEPTS DEVELOPED IN THIS DRAWING SHALL REMAIN AT ALL TIMES THE SOLE PROPERTY OF CANADIAN TIMBERFRAMES LTD.

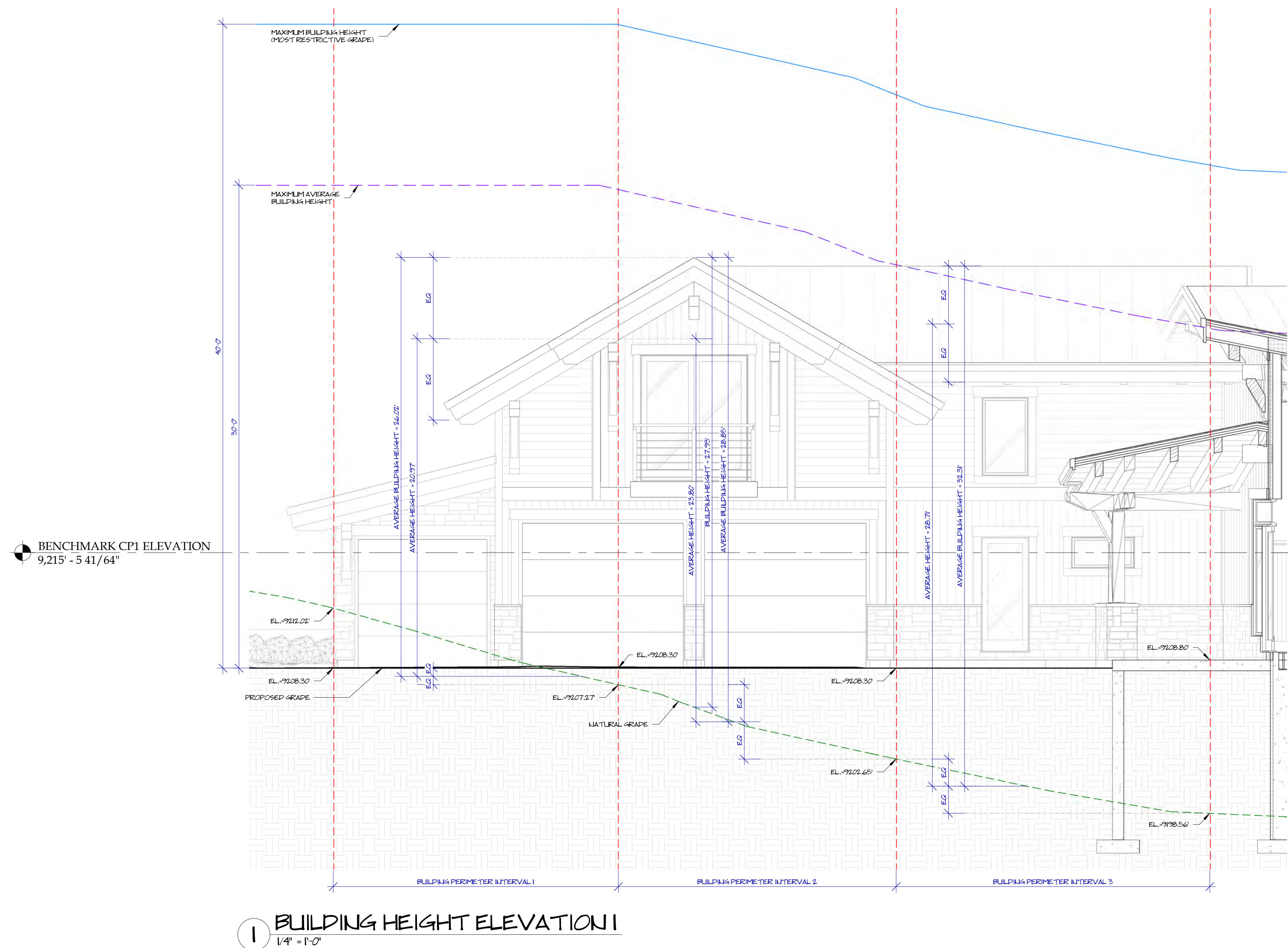

P.O. BOX 1665
GOLDEN, BRITISH COLUMBIA, CANADA
V0A 1H0

OFFICE: (250) 348-2231
FAX: (250) 348-2241
WEB: WWW.CANADIANTIMBERFRAMES.COM

BUILDING HEIGHT ELEVATION

MOODY RESIDENCE
20130
2021-05-25 12:47:18 PM

ISSUED FOR: DRB REVIEW

THESE DRAWINGS ARE THE PROPERTY OF CANADIAN TIMBERFRAMES LTD. AND MAY NOT BE REPRODUCED OR COPIED WITHOUT OUR WRITTEN CONSENT. ALL DESIGNS, IDEAS, AND CONCEPTS DEVELOPED IN THIS DRAWING SHALL REMAIN AT ALL TIMES THE SOLE PROPERTY OF CANADIAN TIMBERFRAMES LTD.

A-5.2

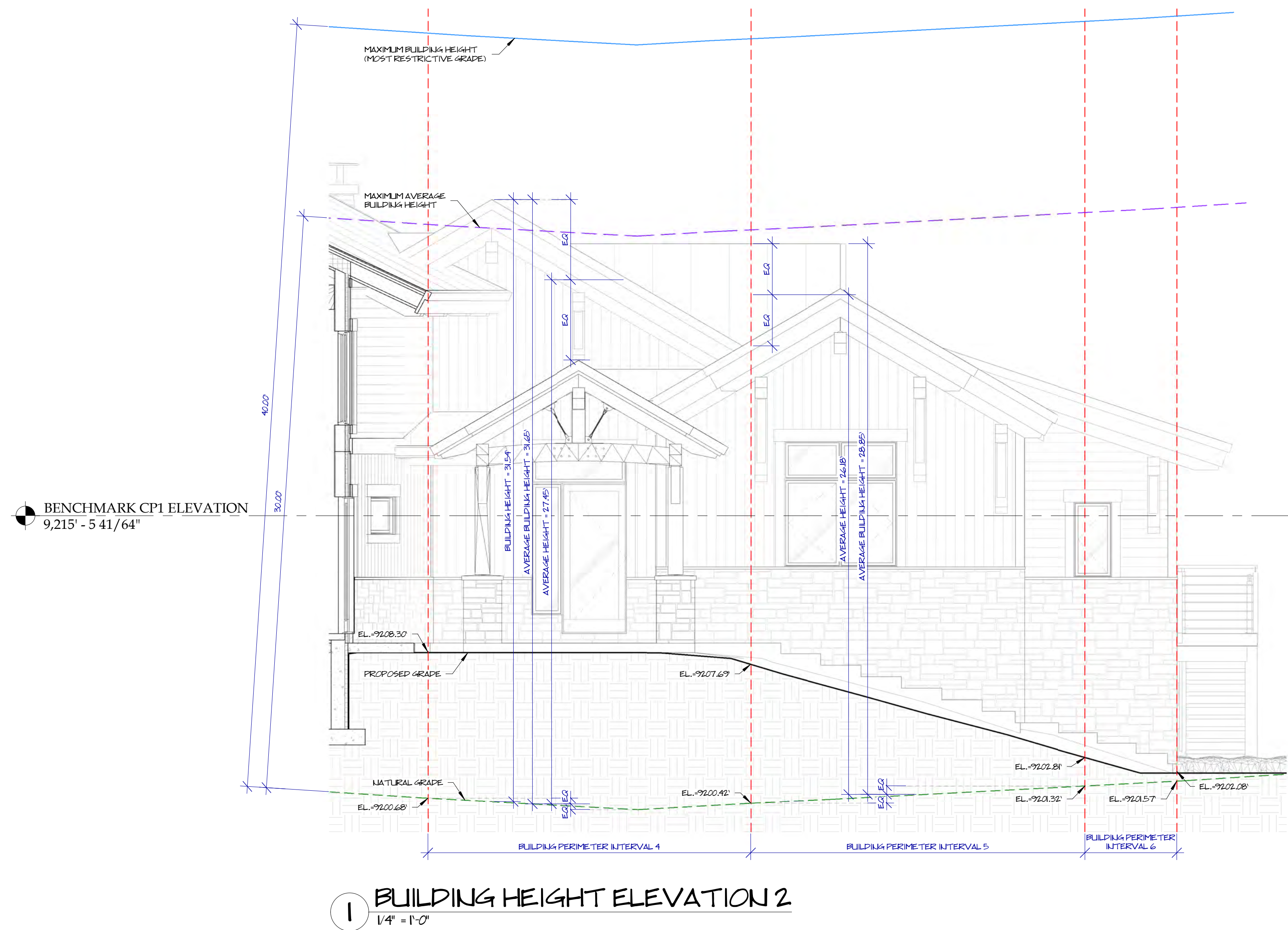

P.O. BOX 1665
GOLDEN, BRITISH COLUMBIA, CANADA
V0A 1H0

OFFICE: (250) 348-2231
FAX: (250) 348-2241
WEB: WWW.CANADIANTIMBERFRAMES.COM

BUILDING HEIGHT ELEVATION

MOODY RESIDENCE
20130
2021-05-25 12:47:22 PM

ISSUED FOR: DRB REVIEW

THESE DRAWINGS ARE THE PROPERTY OF CANADIAN TIMBERFRAMES LTD. AND MAY NOT BE REPRODUCED OR COPIED WITHOUT OUR WRITTEN CONSENT. ALL DESIGNS, IDEAS, AND CONCEPTS DEVELOPED IN THIS DRAWING SHALL REMAIN AT ALL TIMES THE SOLE PROPERTY OF CANADIAN TIMBERFRAMES LTD.

A-5.3

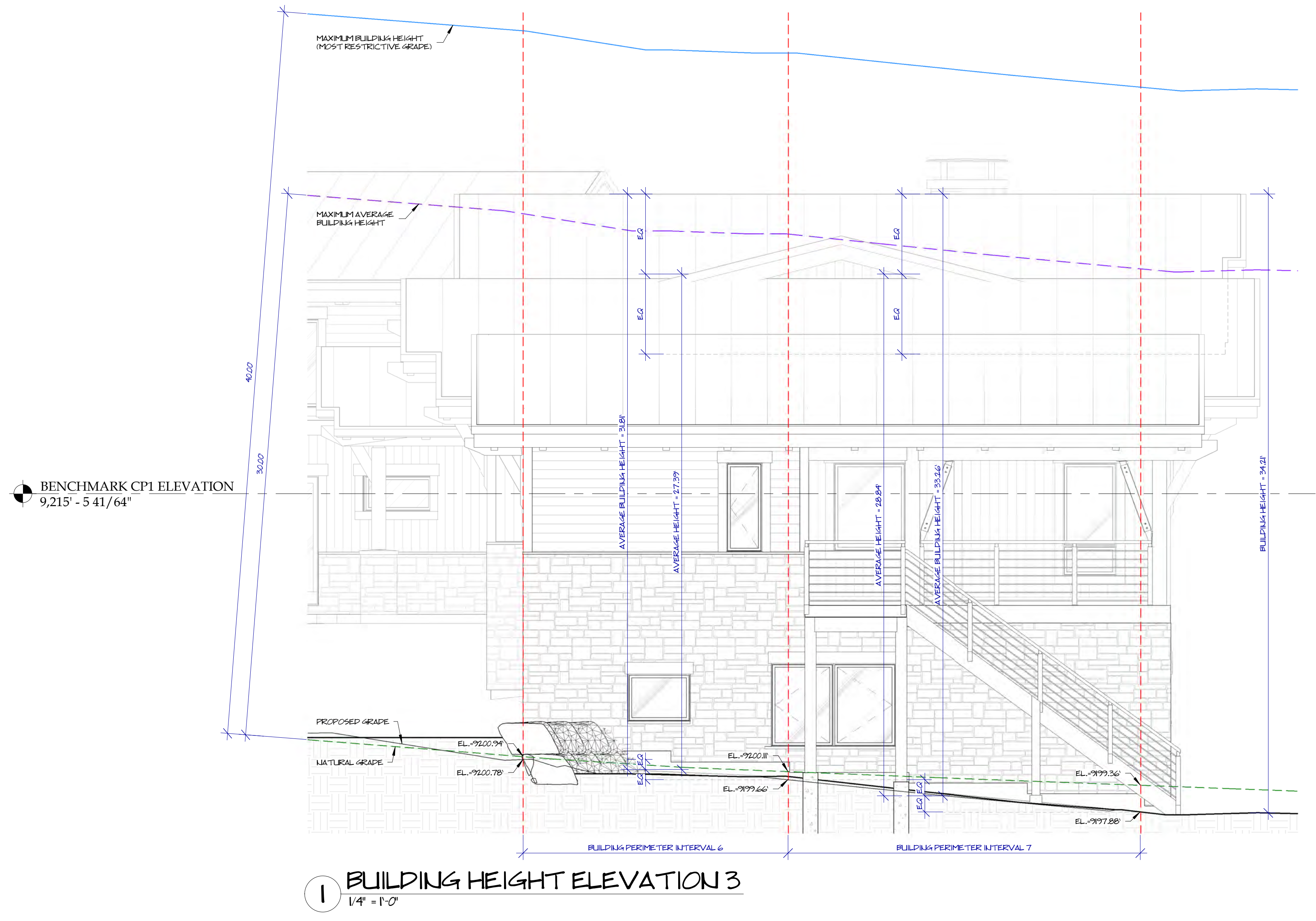

P.O. BOX 1665
GOLDEN, BRITISH COLUMBIA, CANADA
V0A 1H0

OFFICE: (250) 348-2231
FAX: (250) 348-2241
WEB: WWW.CANADIANTIMBERFRAMES.COM

BUILDING HEIGHT ELEVATION

MOODY RESIDENCE
20130
2021-05-25 12:47:27 PM

ISSUED FOR: DRB REVIEW

THESE DRAWINGS ARE THE PROPERTY OF CANADIAN TIMBERFRAMES LTD. AND MAY NOT BE REPRODUCED OR COPIED WITHOUT OUR WRITTEN CONSENT. ALL DESIGNS, IDEAS, AND CONCEPTS DEVELOPED IN THIS DRAWING SHALL REMAIN AT ALL TIMES THE SOLE PROPERTY OF CANADIAN TIMBERFRAMES LTD.

A-5.4

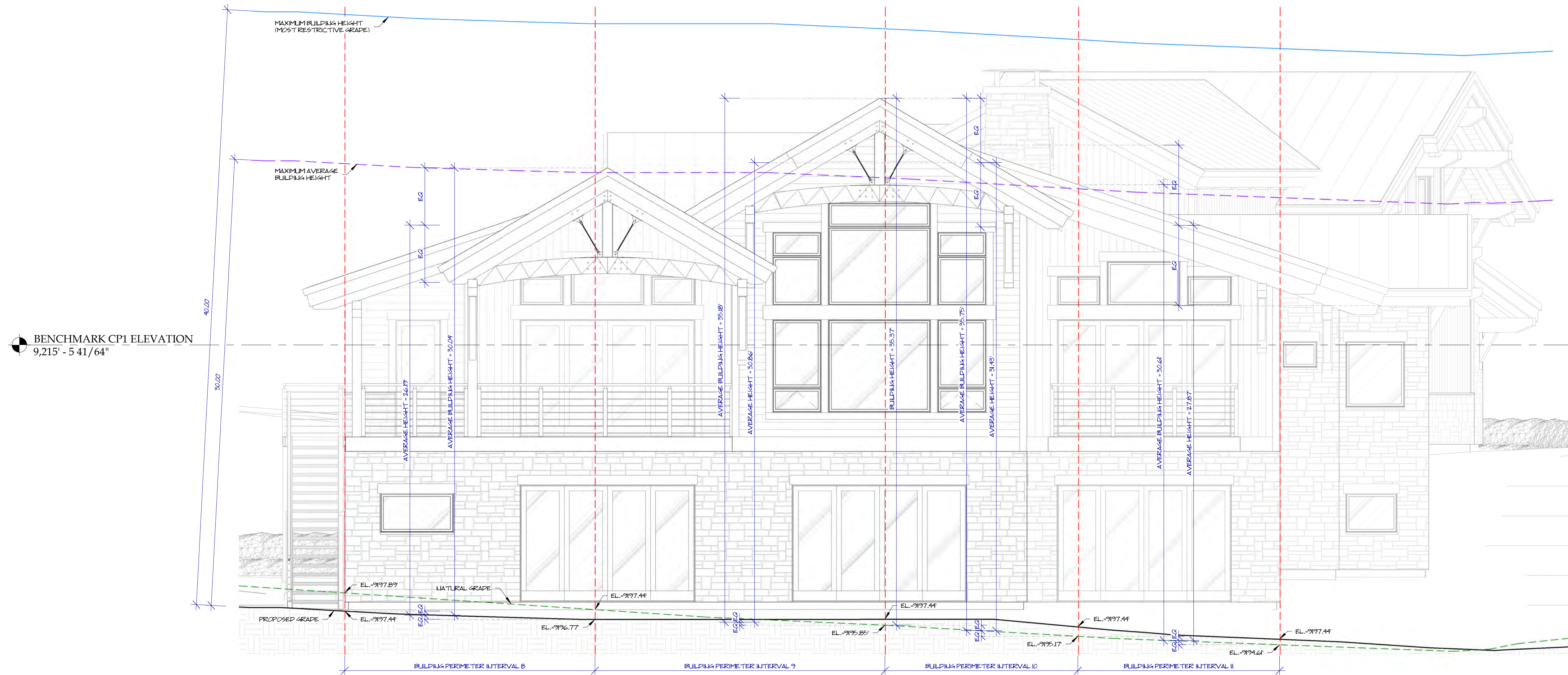

BENCHMARK CPI ELEVATION
9,215' - 5 41/64"

1 BUILDING HEIGHT ELEVATION 4
1/4" = 1'-0"



P.O. BOX 1665
GOLDEN, BRITISH COLUMBIA, CANADA
V0A 1H0

OFFICE: (250) 348-2231
FAX: (250) 348-2241
WEB: WWW.CANADIANTIMBERFRAMES.COM

BUILDING HEIGHT ELEVATION

MOODY RESIDENCE
20130
2021-05-25 12:47:32 PM

ISSUED FOR: DRB REVIEW

THESE DRAWINGS ARE THE PROPERTY OF CANADIAN TIMBERFRAMES LTD. AND MAY NOT BE REPRODUCED OR COPIED WITHOUT OUR WRITTEN CONSENT. ALL DESIGNS, IDEAS, AND CONCEPTS DEVELOPED IN THIS DRAWING SHALL REMAIN AT ALL TIMES THE SOLE PROPERTY OF CANADIAN TIMBERFRAMES LTD.

A-5.5

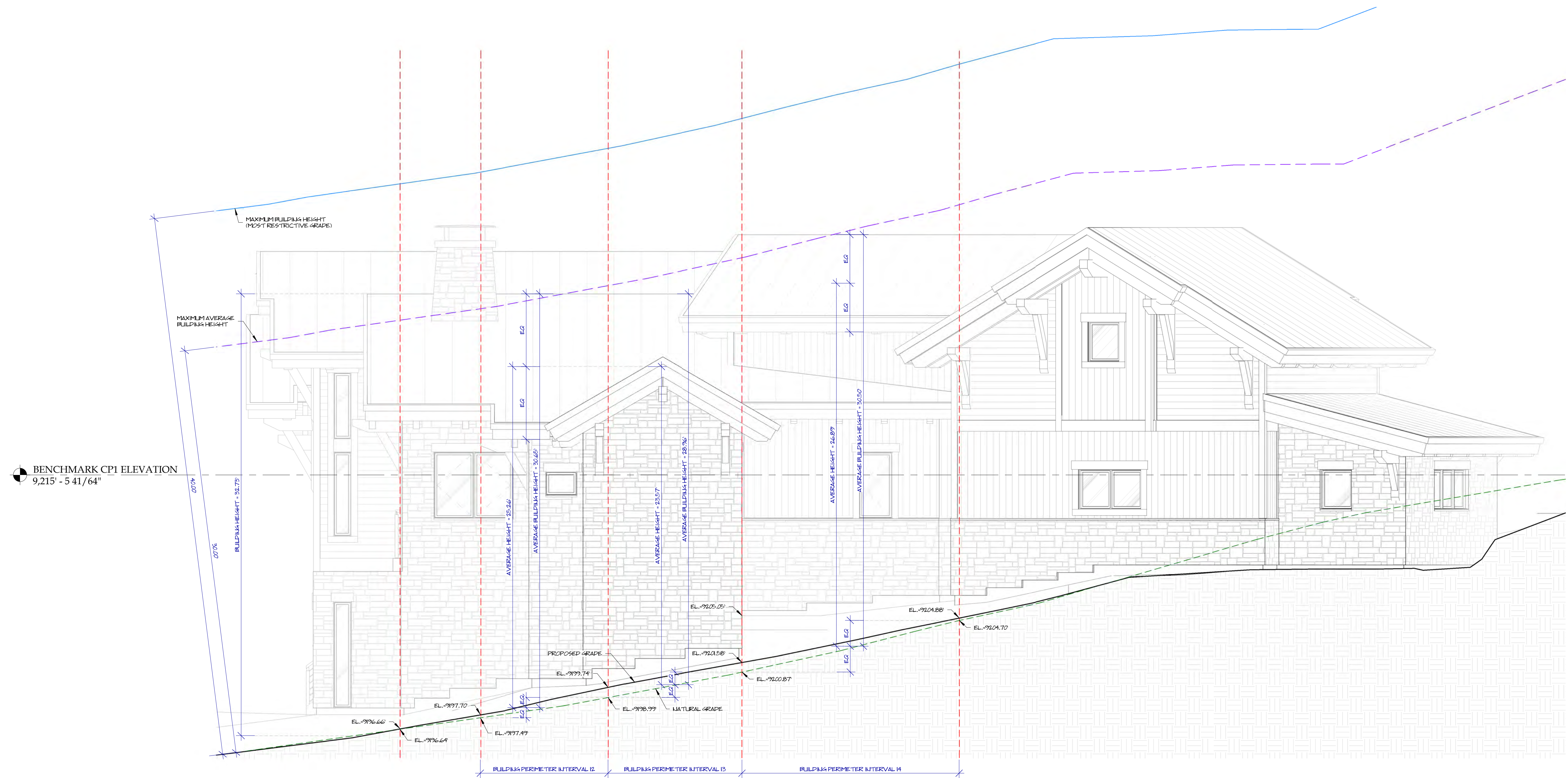

1 BUILDING HEIGHT ELEVATIONS
1/4" = 1'-0"



P.O. BOX 1665
GOLDEN, BRITISH COLUMBIA, CANADA
V0A 1H0

OFFICE: (250) 348-2231
FAX: (250) 348-2241
WEB: WWW.CANADIANTIMBERFRAMES.COM

BUILDING HEIGHT ELEVATION

MOODY RESIDENCE
20130
2021-05-25 12:47:37 PM

ISSUED FOR: DRB REVIEW

THESE DRAWINGS ARE THE PROPERTY OF CANADIAN TIMBERFRAMES LTD. AND MAY NOT BE REPRODUCED OR COPIED WITHOUT OUR WRITTEN CONSENT. ALL DESIGNS, IDEAS, AND CONCEPTS DEVELOPED IN THIS DRAWING SHALL REMAIN AT ALL TIMES THE SOLE PROPERTY OF CANADIAN TIMBERFRAMES LTD.

A-5.6

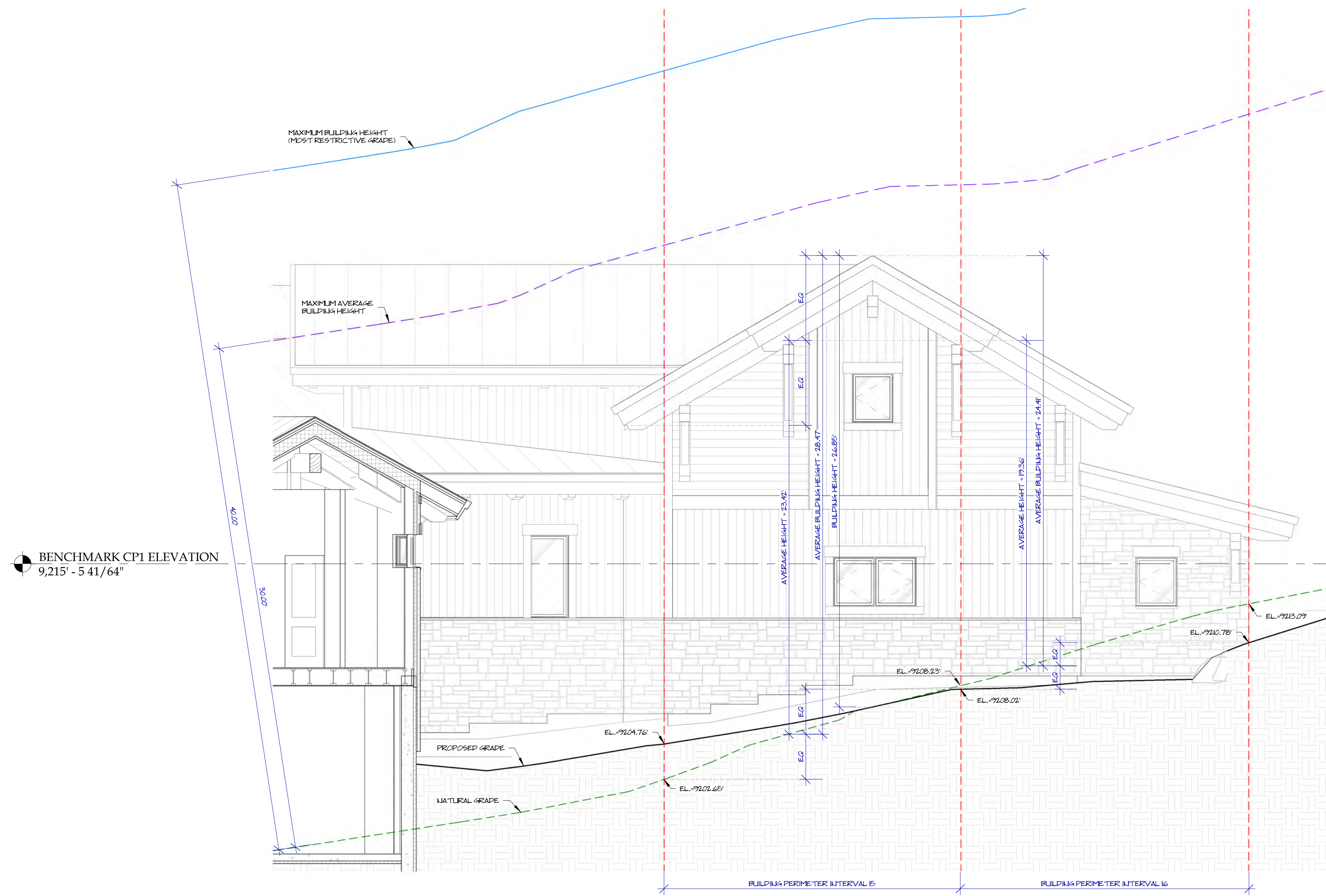

1 BUILDING HEIGHT ELEVATION 6
1/4" = 1'-0"



P.O. BOX 1665
GOLDEN, BRITISH COLUMBIA, CANADA
V0A 1H0

OFFICE: (250) 348-2231
FAX: (250) 348-2241
WEB: WWW.CANADIANTIMBERFRAMES.COM

BUILDING HEIGHT ELEVATION

MOODY RESIDENCE
20130
2021-05-25 12:47:41 PM

ISSUED FOR: DRB REVIEW

THESE DRAWINGS ARE THE PROPERTY OF CANADIAN TIMBERFRAMES LTD. AND MAY NOT BE REPRODUCED OR COPIED WITHOUT OUR WRITTEN CONSENT. ALL DESIGNS, IDEAS, AND CONCEPTS DEVELOPED IN THIS DRAWING SHALL REMAIN AT ALL TIMES THE SOLE PROPERTY OF CANADIAN TIMBERFRAMES LTD.

A-5.7

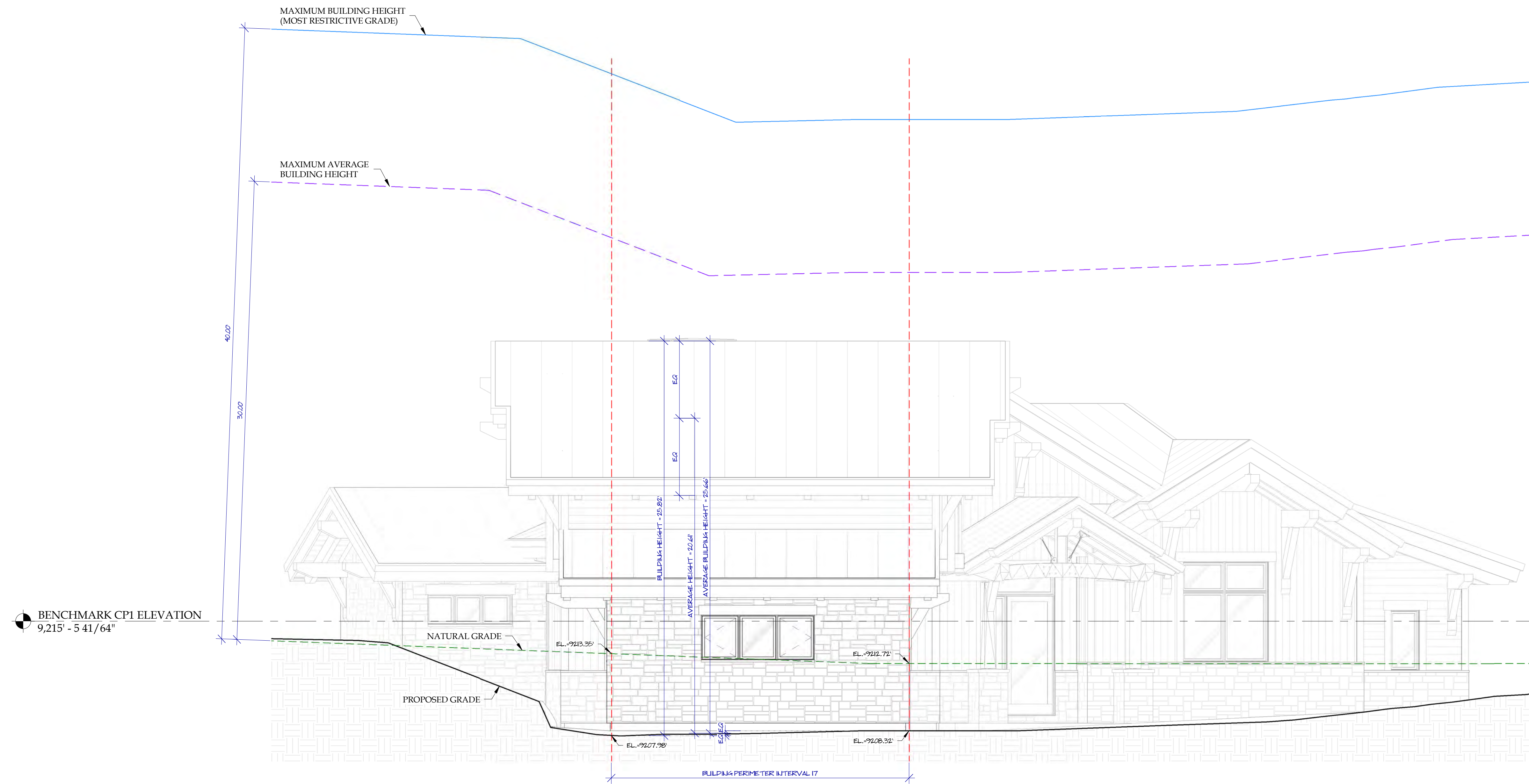

1 BUILDING HEIGHT ELEVATION 7
1/4" = 1'-0"



P.O. BOX 1665
GOLDEN, BRITISH COLUMBIA, CANADA
V0A 1H0

OFFICE: (250) 348-2231
FAX: (250) 348-2241
WEB: WWW.CANADIANTIMBERFRAMES.COM

BUILDING HEIGHT ELEVATION

MOODY RESIDENCE
20130
2021-05-25 12:47:45 PM

ISSUED FOR: DRB REVIEW

THESE DRAWINGS ARE THE PROPERTY OF CANADIAN TIMBERFRAMES LTD. AND MAY NOT BE REPRODUCED OR COPIED WITHOUT OUR WRITTEN CONSENT. ALL DESIGNS, IDEAS, AND CONCEPTS DEVELOPED IN THIS DRAWING SHALL REMAIN AT ALL TIMES THE SOLE PROPERTY OF CANADIAN TIMBERFRAMES LTD.

A-5.8

FRONT ELEVATION (SOUTH)					
Component	Total Square Footage		Total Sq. Ft.	%	
Exterior Wall	873.83		873.83	100.00%	
Stone	410.19		410.19	46.94%	
Stucco	0.00		0.00	0.00%	
Wood Siding	Horizontal Siding	Vertical Siding	272.38	31.17%	
	40.53	231.85			
Accent Material	Timber	Cedar Trim	Metal Sill	111.82	12.80%
	55.91	46.74	9.17		
Fenestration	104.05		104.05	11.91%	

RIGHT SIDE ELEVATION (EAST)					
Component	Total Square Footage		Total Sq. Ft.	%	
Exterior Wall	874.26		874.26	100.00%	
Stone	351.45		351.45	40.20%	
Stucco	0.00		0.00	0.00%	
Wood Siding	Horizontal Siding	Vertical Siding	302.82	34.64%	
	77.19	225.63			
Accent Material	Timber	Cedar Trim	Metal Sill	103.97	11.89%
	0.00	100.19	3.78		
Fenestration	88.10		88.10	10.08%	

LEFT SIDE ELEVATION (WEST)					
Component	Total Square Footage		Total Sq. Ft.	%	
Exterior Wall	949.26		949.26	100.00%	
Stone	626.11		626.11	65.96%	
Stucco	0.00		0.00	0.00%	
Wood Siding	Horizontal Siding	Vertical Siding	157.36	16.58%	
	62.44	94.92			
Accent Material	Timber	Cedar Trim	Metal Sill	61.29	6.46%
	5.56	52.88	2.85		
Fenestration	70.15		70.15	7.39%	

REAR ELEVATION (SOUTH)					
Component	Total Square Footage		Total Sq. Ft.	%	
Exterior Wall	1898.18		1898.18	100.00%	
Stone	551.55		551.55	29.06%	
Stucco	0.00		0.00	0.00%	
Wood Siding	Horizontal Siding	Vertical Siding	300.25	15.82%	
	150.41	149.84			
Accent Material	Timber	Cedar Trim	Metal Sill	309.31	16.30%
	34.67	272.19	2.45		
Fenestration	744.16		744.16	39.20%	

TOTAL BUILDING					
Component	Total Square Footage		Total Sq. Ft.	%	
Exterior Wall	6929.38		6929.38	100.00%	
Stone	2427.62		2427.62	35.03%	
Stucco	0.00		0.00	0.00%	
Wood Siding	Horizontal Siding	Vertical Siding	2131.76	30.76%	
	772.74	1359.02			
Accent Material	Timber	Cedar Trim	Metal Sill	981.92	14.17%
	144.25	795.75	41.92		
Fenestration	1397.71		1397.71	20.17%	

GARAGE FRONT ELEVATION (SOUTH EAST)					
Component	Total Square Footage		Total Sq. Ft.	%	
Exterior Wall	1023.40		1023.40	100.00%	
Stone	104.08		104.08	10.17%	
Stucco	0.00		0.00	0.00%	
Wood Siding	Horizontal Siding	Vertical Siding	383.43	37.47%	
	216.63	166.80			
Accent Material	Timber	Cedar Trim	Metal Sill	182.47	17.83%
	15.77	149.06	17.64		
Fenestration	340.43		340.43	33.26%	

GARAGE SIDE ELEVATION (SOUTH WEST)					
Component	Total Square Footage		Total Sq. Ft.	%	
Exterior Wall	358.87		358.87	100.00%	
Stone	154.79		154.79	43.13%	
Stucco	0.00		0.00	0.00%	
Wood Siding	Horizontal Siding	Vertical Siding	198.48	55.31%	
	80.94	117.54			
Accent Material	Timber	Cedar Trim	Metal Sill	59.59	16.60%
	13.61	44.43	1.55		
Fenestration	21.78		21.78	6.07%	

GARAGE SIDE ELEVATION (NORTH EAST)					
Component	Total Square Footage		Total Sq. Ft.	%	
Exterior Wall	198.35		198.35	100.00%	
Stone	29.50		29.50	14.87%	
Stucco	0.00		0.00	0.00%	
Wood Siding	Horizontal Siding	Vertical Siding	118.97	59.98%	
	29.51	89.46			
Accent Material	Timber	Cedar Trim	Metal Sill	49.93	25.17%
	3.02	46.14	0.77		
Fenestration	0.00		0.00	0.00%	

GARAGE REAR ELEVATION (NORTH WEST)					
Component	Total Square Footage		Total Sq. Ft.	%	
Exterior Wall	753.23		753.23	100.00%	
Stone	199.95		199.95	26.55%	
Stucco	0.00		0.00	0.00%	
Wood Siding	Horizontal Siding	Vertical Siding	398.07	52.85%	
	115.09	282.98			
Accent Material	Timber	Cedar Trim	Metal Sill	103.54	13.75%
	15.71	84.12	3.71		
Fenestration	29.04		29.04	3.86%	

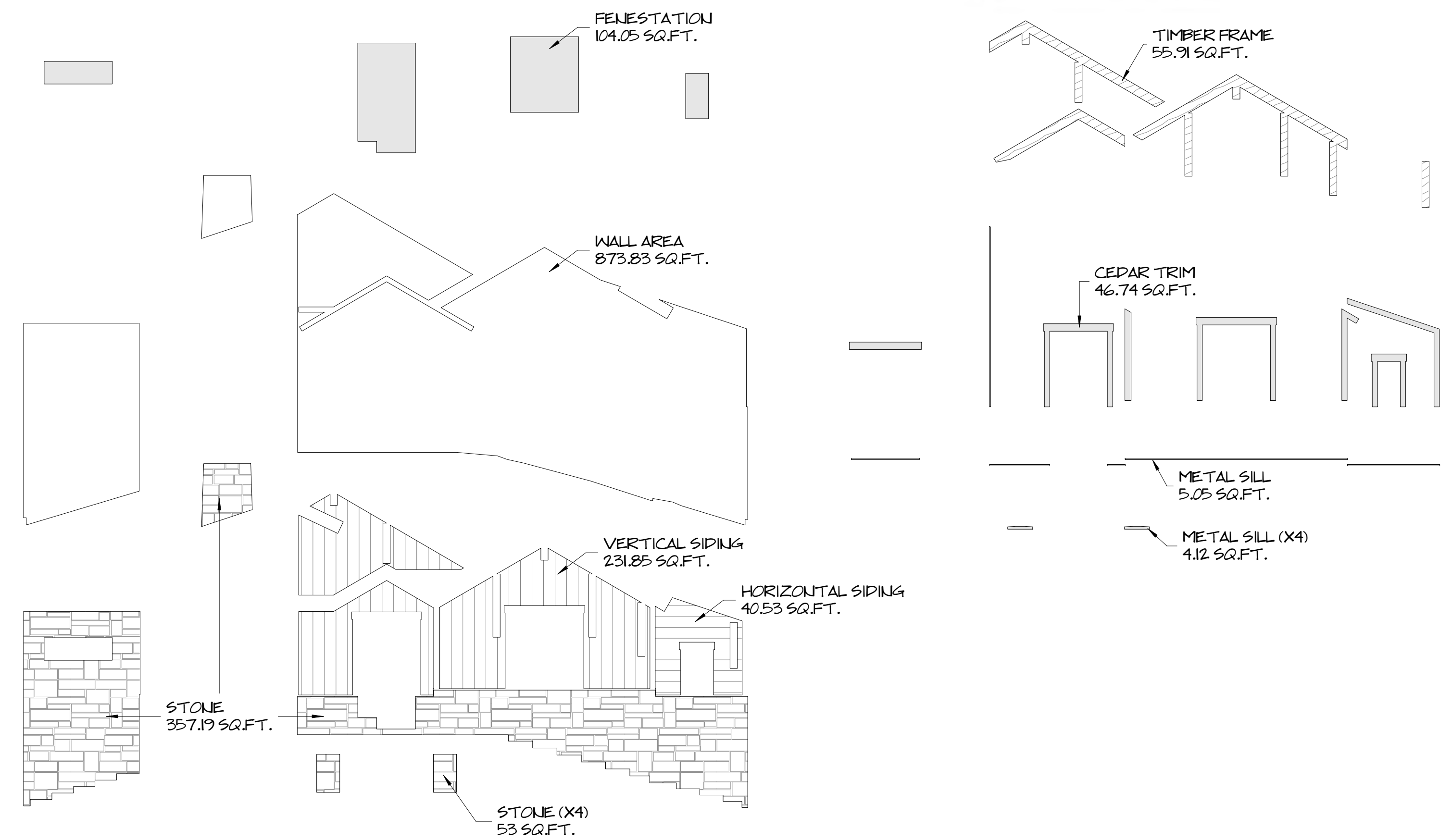

1 WALL AREAS - FRONT (SOUTH) ELEVATION
1/8" = 1'-0"



WALL AREAS

P.O. BOX 1665
GOLDEN, BRITISH COLUMBIA, CANADA
V0A 1H0

OFFICE: (250) 348-2231
FAX: (250) 348-2241
WEB: WWW.CANADIANTIMBERFRAMES.COM

MOODY RESIDENCE
20130
2021-05-25 12:47:54 PM

ISSUED FOR: DRB REVIEW

THESE DRAWINGS ARE THE PROPERTY OF CANADIAN TIMBERFRAMES LTD. AND MAY NOT BE REPRODUCED OR COPIED WITHOUT OUR WRITTEN CONSENT. ALL DESIGNS, IDEAS, AND CONCEPTS DEVELOPED IN THIS DRAWING SHALL REMAIN AT ALL TIMES THE SOLE PROPERTY OF CANADIAN TIMBERFRAMES LTD.

A-6.1

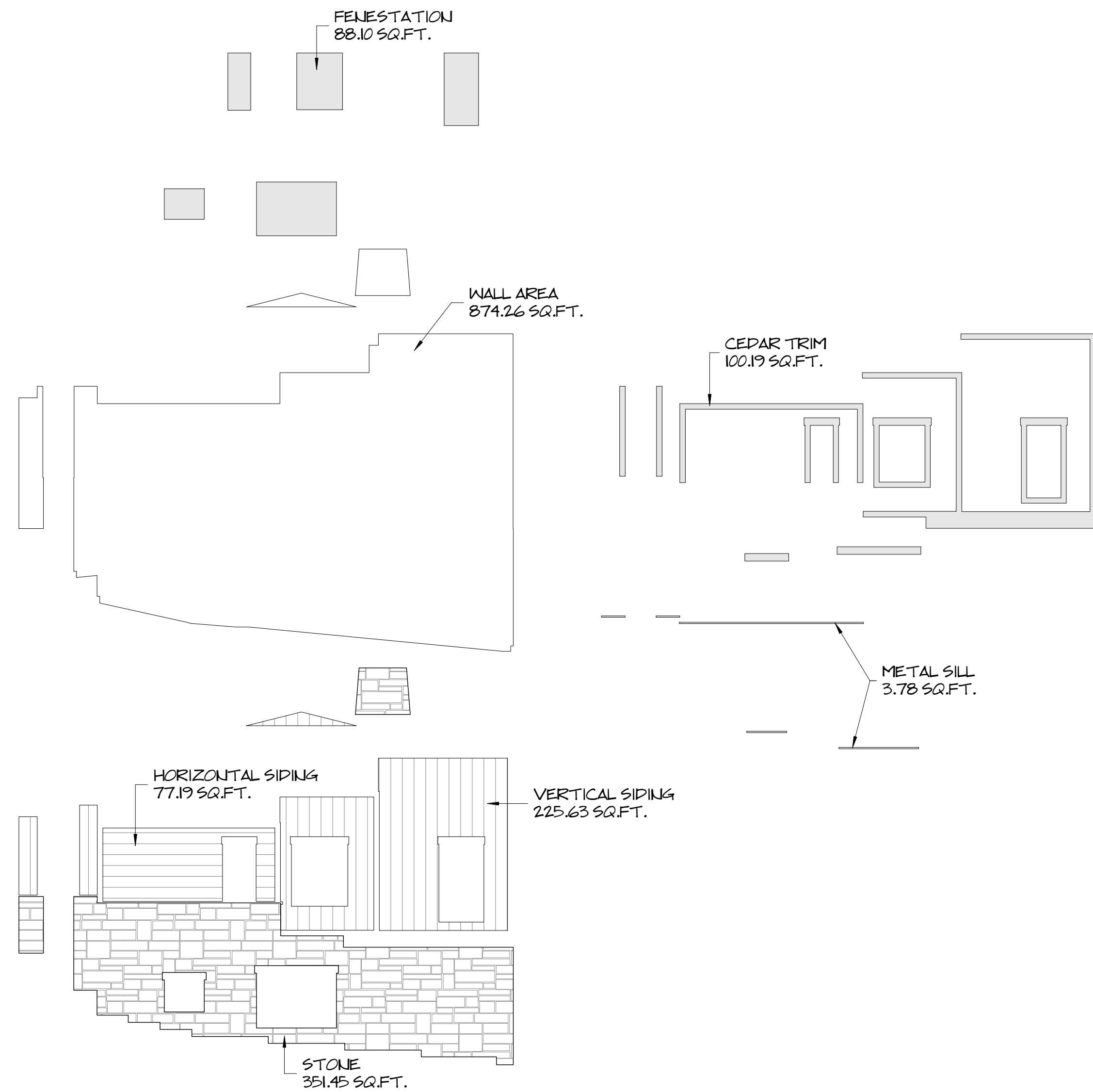

1 WALL AREAS - RIGHT SIDE (EAST) ELEVATION
1/8" = 1'-0"

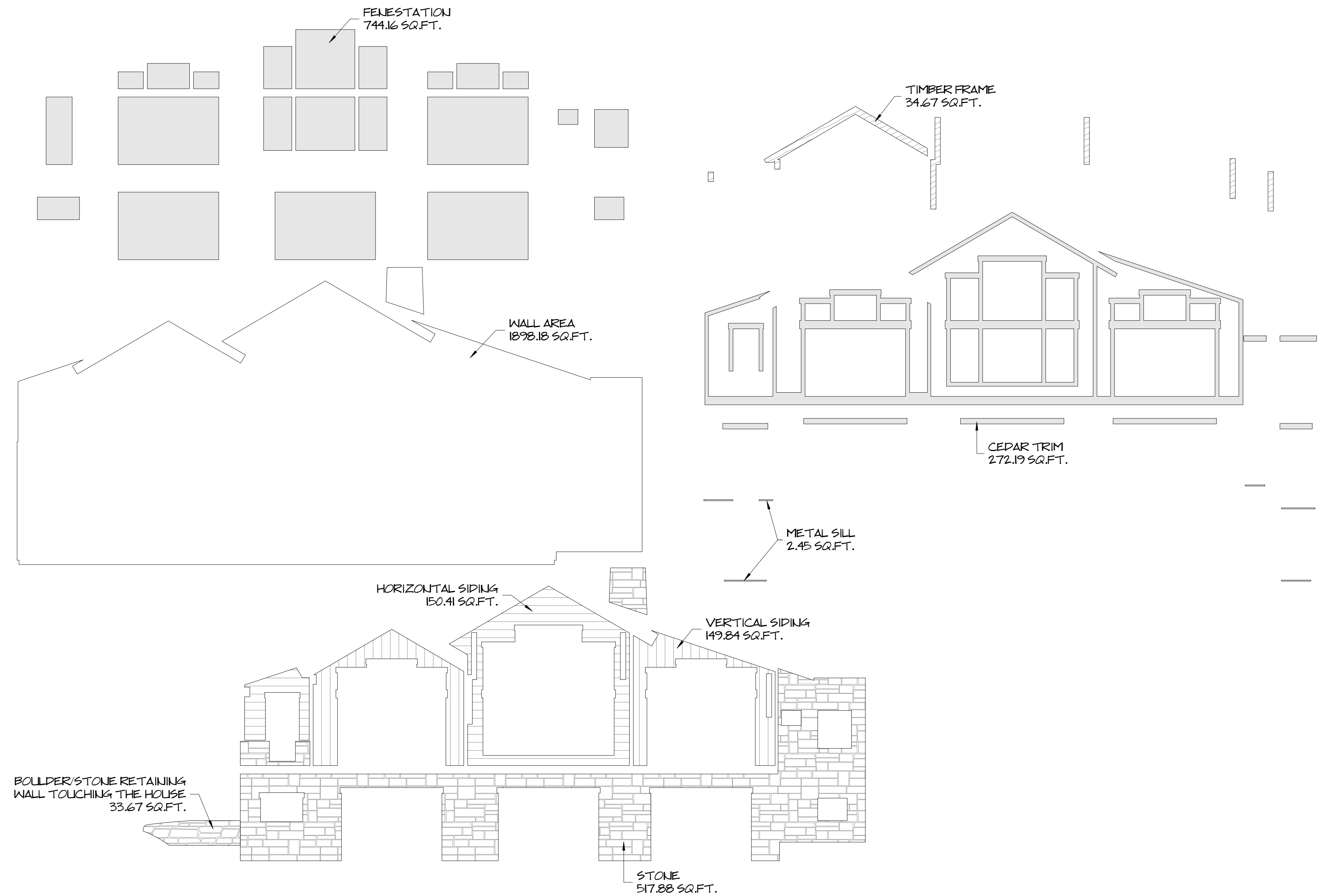

2 WALL AREAS - REAR (NORTH) ELEVATION
1/8" = 1'-0"



WALL AREAS

P.O. BOX 1665
GOLDEN, BRITISH COLUMBIA, CANADA
V0A 1H0

OFFICE: (250) 348-2231
FAX: (250) 348-2241
WEB: WWW.CANADIANTIMBERFRAMES.COM

MOODY RESIDENCE
20130
2021-05-25 12:48:08 PM

ISSUED FOR: DRB REVIEW

THESE DRAWINGS ARE THE PROPERTY OF CANADIAN TIMBERFRAMES LTD. AND MAY NOT BE REPRODUCED OR COPIED WITHOUT OUR WRITTEN CONSENT. ALL DESIGNS, IDEAS, AND CONCEPTS DEVELOPED IN THIS DRAWING SHALL REMAIN AT ALL TIMES THE SOLE PROPERTY OF CANADIAN TIMBERFRAMES LTD.

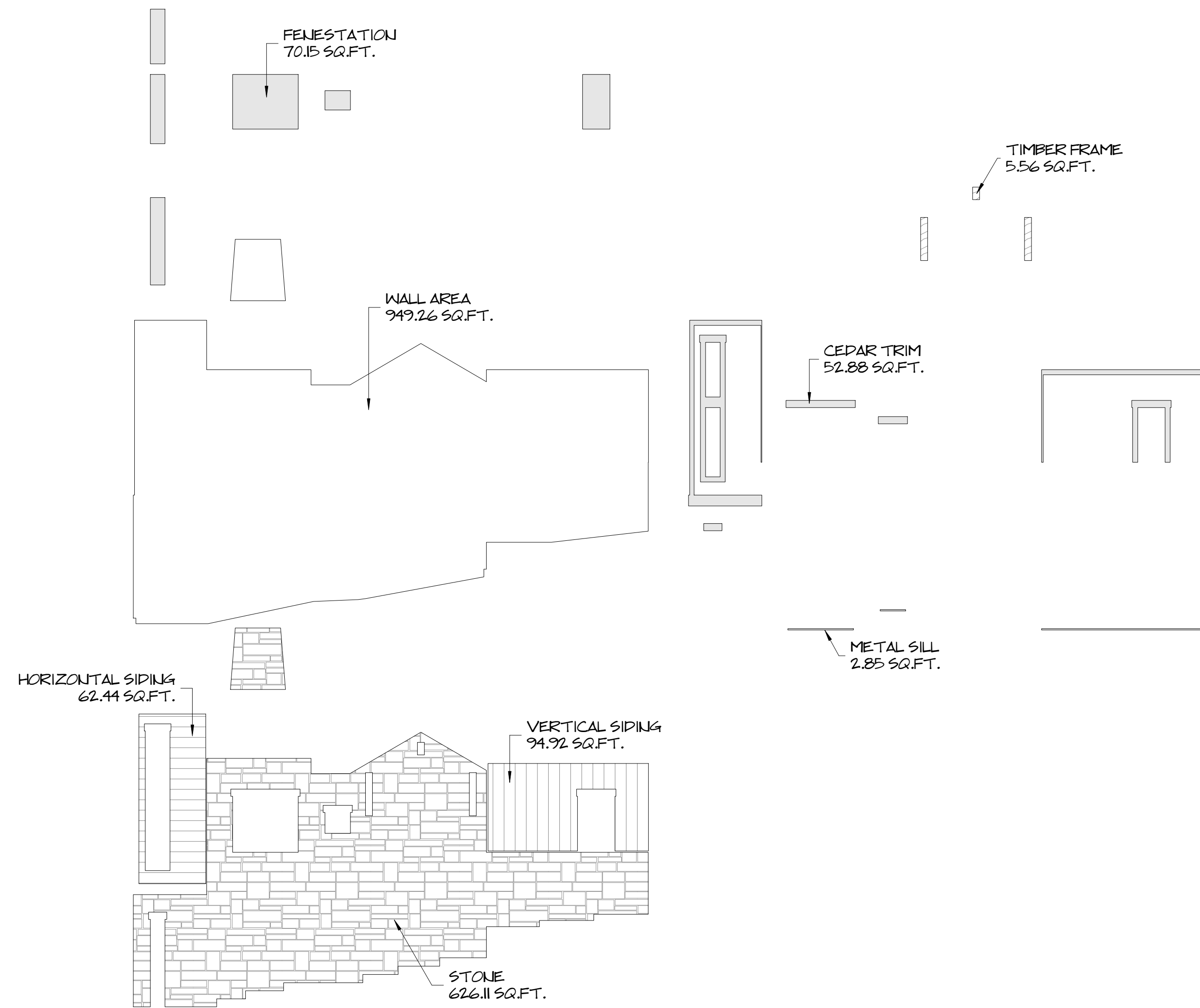

1 WALL AREAS - LEFT SIDE (WEST) ELEVATION
1/8" = 1'-0"

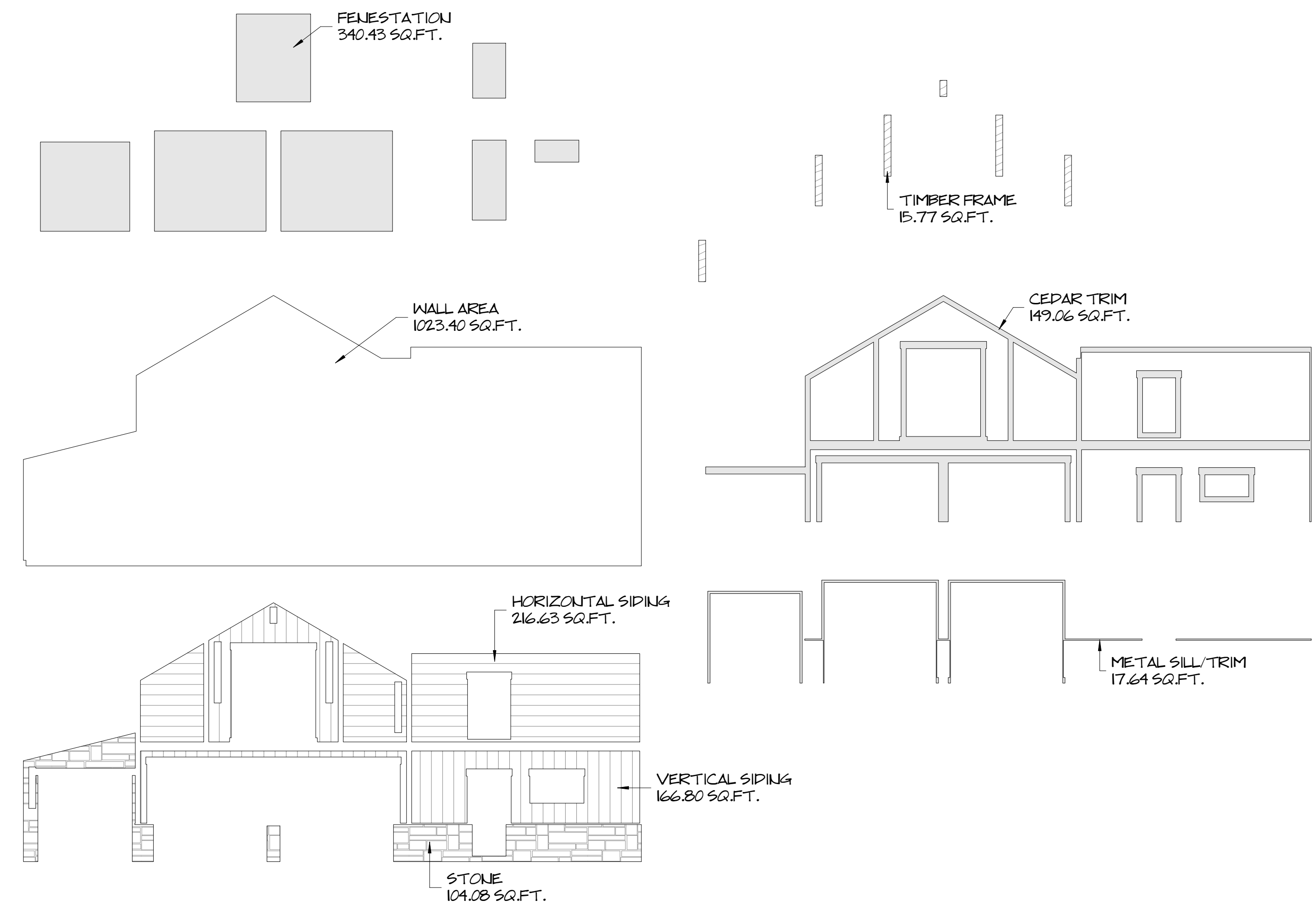

2 WALL AREAS - GARAGE FRONT (SOUTH EAST) ELEVATION
1/8" = 1'-0"



WALL AREAS

P.O. BOX 1665
GOLDEN, BRITISH COLUMBIA, CANADA
V0A 1H0

OFFICE: (250) 348-2231
FAX: (250) 348-2241
WEB: WWW.CANADIANTIMBERFRAMES.COM

MOODY RESIDENCE
20130
2021-05-25 12:48:26 PM

ISSUED FOR: DRB REVIEW

THESE DRAWINGS ARE THE PROPERTY OF CANADIAN TIMBERFRAMES LTD. AND MAY NOT BE REPRODUCED OR COPIED WITHOUT OUR WRITTEN CONSENT. ALL DESIGNS, IDEAS, AND CONCEPTS DEVELOPED IN THIS DRAWING SHALL REMAIN AT ALL TIMES THE SOLE PROPERTY OF CANADIAN TIMBERFRAMES LTD.

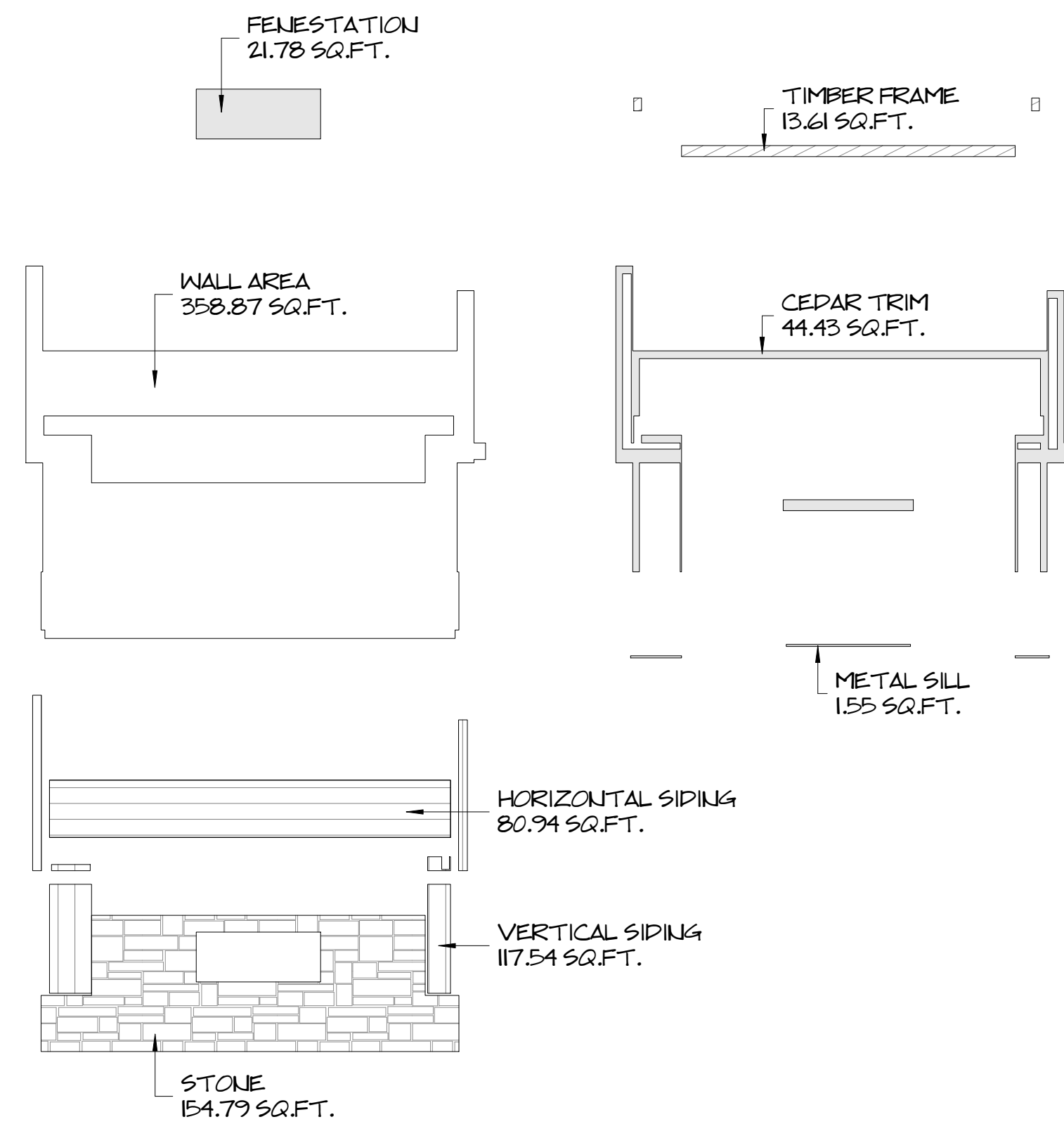

1 WALL AREAS - GARAGE SIDE (SOUTH WEST) ELEVATION
1/8" = 1'-0"

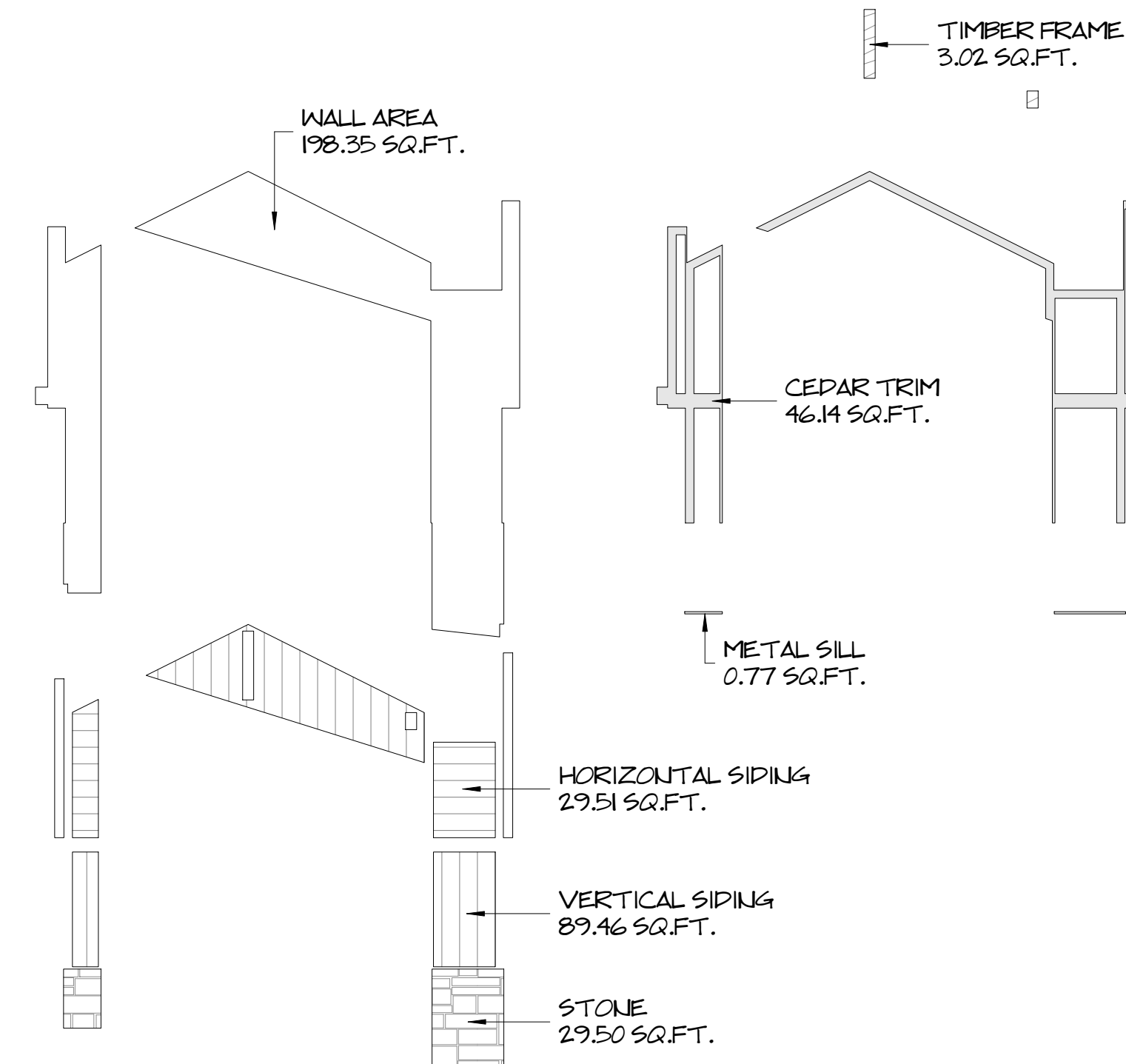

2 WALL AREAS - GARAGE SIDE (NORTH EAST) ELEVATION
1/8" = 1'-0"



WALL AREAS

P.O. BOX 1665
GOLDEN, BRITISH COLUMBIA, CANADA
V0A 1H0

OFFICE: (250) 348-2231
FAX: (250) 348-2241
WEB: WWW.CANADIANTIMBERFRAMES.COM

MOODY RESIDENCE
20130
2021-05-25 12:48:34 PM

ISSUED FOR: DRB REVIEW

THESE DRAWINGS ARE THE PROPERTY OF CANADIAN TIMBERFRAMES LTD. AND MAY NOT BE REPRODUCED OR COPIED WITHOUT OUR WRITTEN CONSENT. ALL DESIGNS, IDEAS, AND CONCEPTS DEVELOPED IN THIS DRAWING SHALL REMAIN AT ALL TIMES THE SOLE PROPERTY OF CANADIAN TIMBERFRAMES LTD.

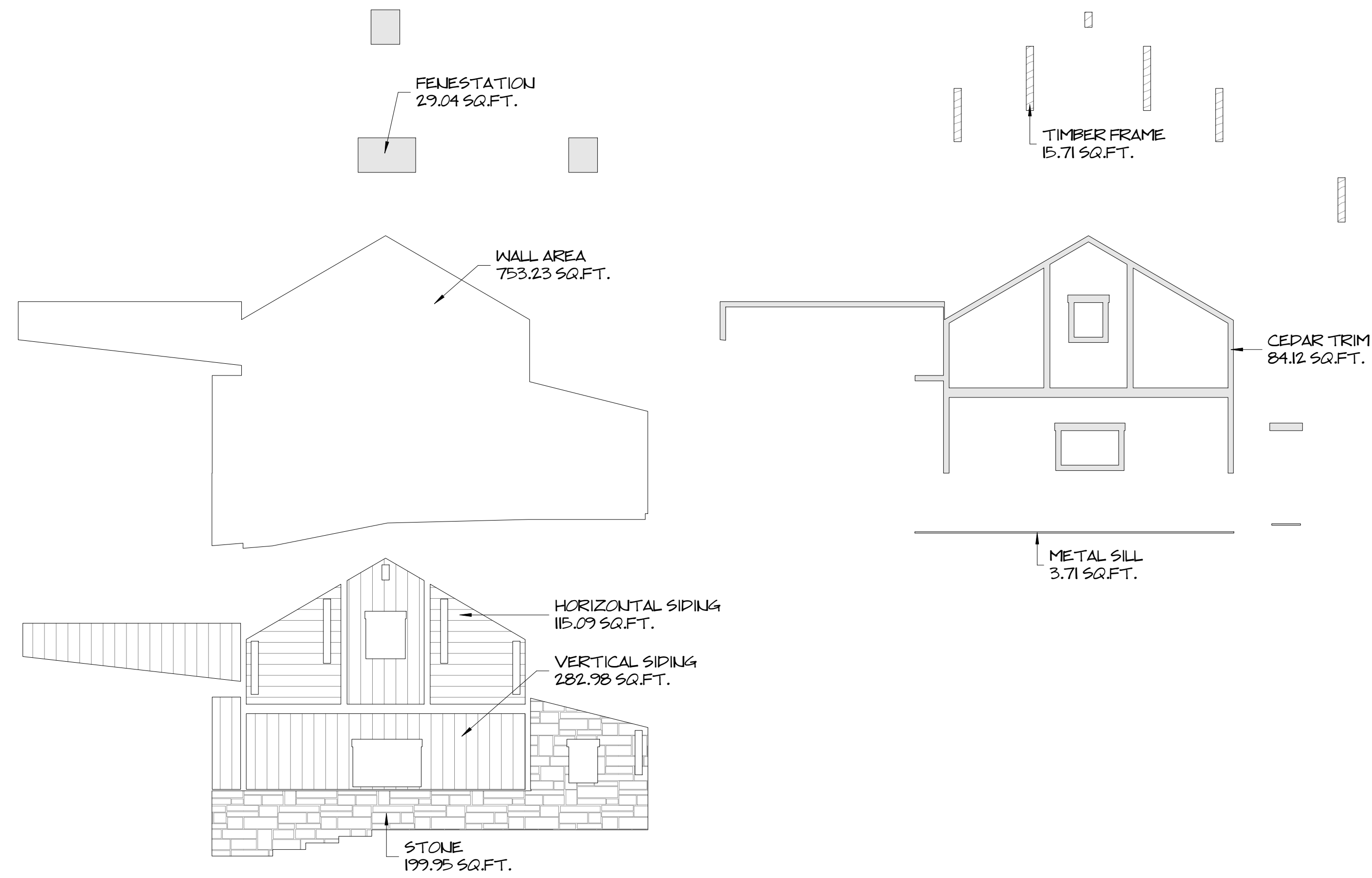

1 WALL AREAS - GARAGE REAR (NORTH WEST)
ELEVATION
1/8" = 1'-0"



WALL AREAS

P.O. BOX 1665
GOLDEN, BRITISH COLUMBIA, CANADA
V0A 1H0

OFFICE: (250) 348-2231
FAX: (250) 348-2241
WEB: WWW.CANADIANTIMBERFRAMES.COM

MOODY RESIDENCE
20130
2021-05-25 12:48:44 PM

ISSUED FOR: DRB REVIEW

THESE DRAWINGS ARE THE PROPERTY OF CANADIAN TIMBERFRAMES LTD. AND MAY NOT BE REPRODUCED OR COPIED WITHOUT OUR WRITTEN CONSENT. ALL DESIGNS, IDEAS, AND CONCEPTS DEVELOPED IN THIS DRAWING SHALL REMAIN AT ALL TIMES THE SOLE PROPERTY OF CANADIAN TIMBERFRAMES LTD.

A-6.5

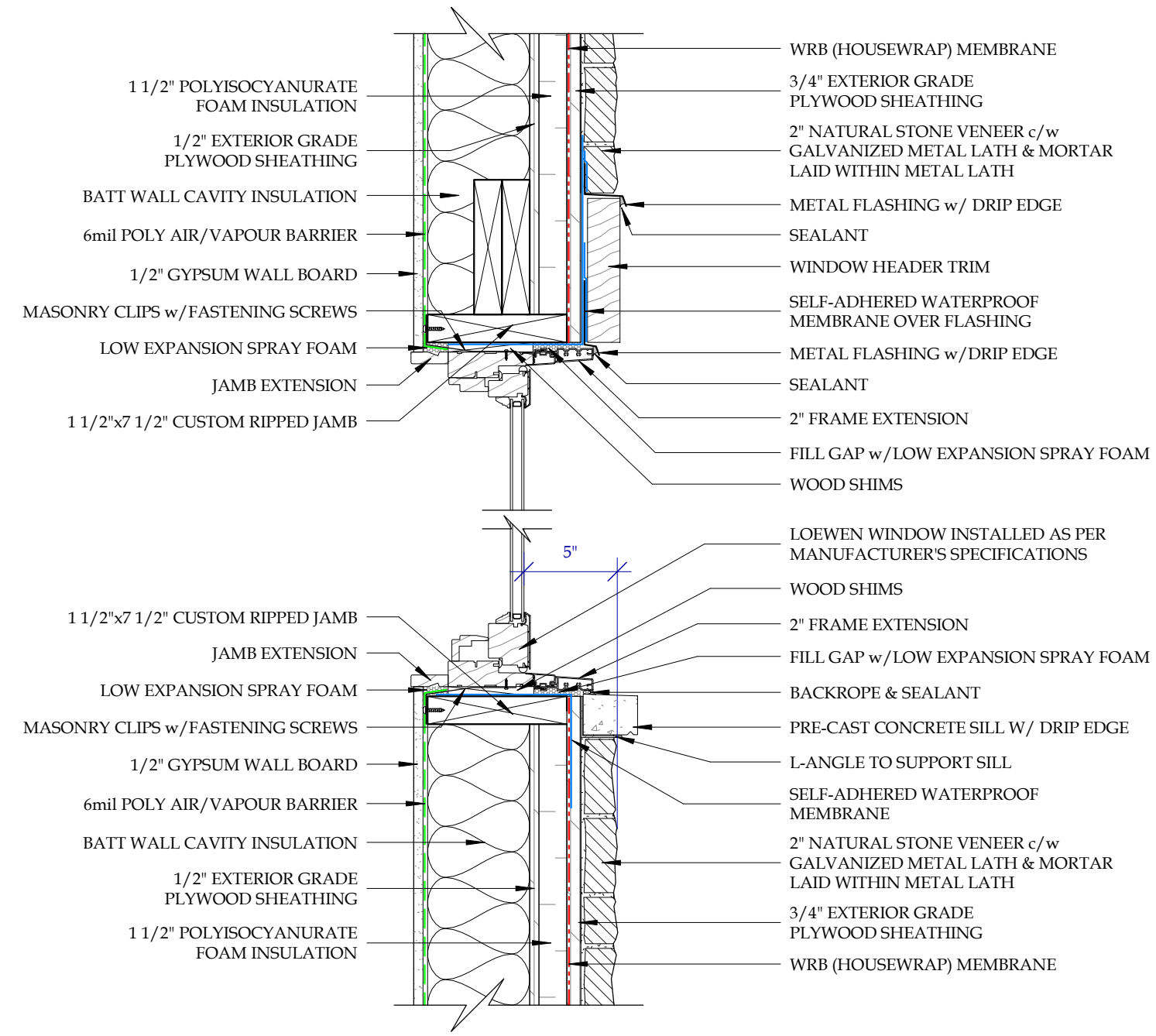

**WINDOW SILL & HEADER DETAIL
AT 2" STONE VENEER**

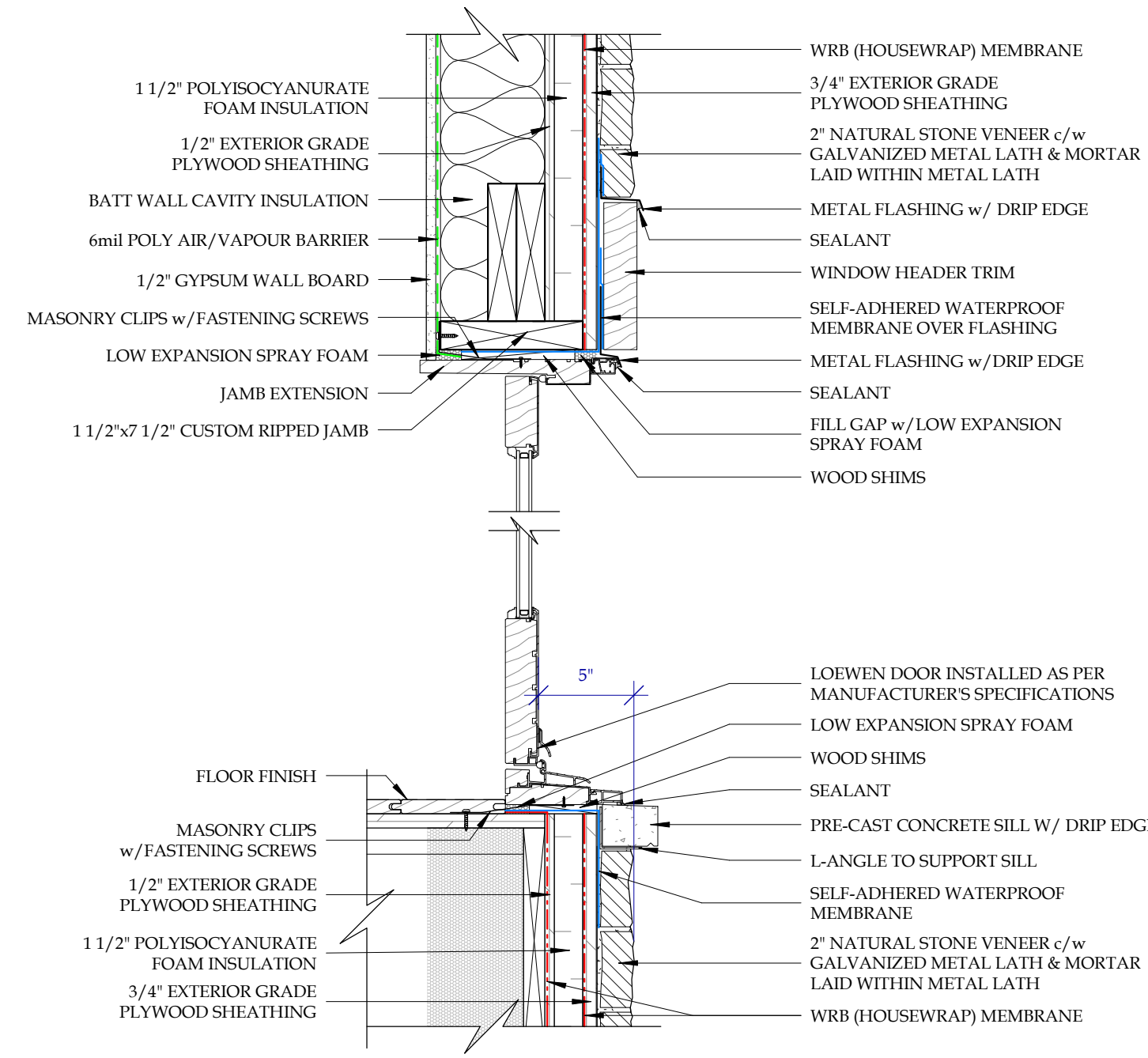

**DOOR SILL & HEADER DETAIL
AT 2" STONE VENEER**

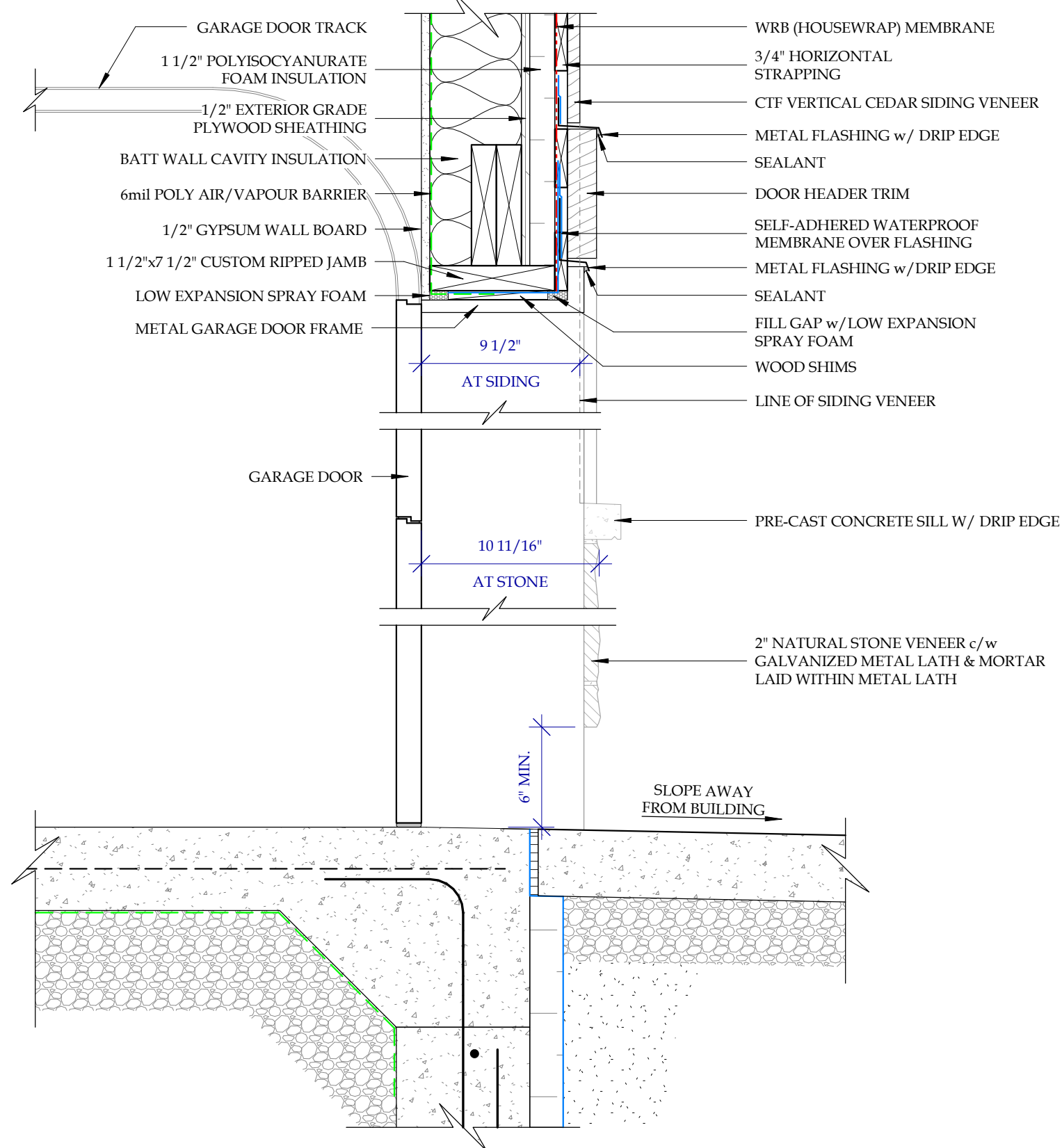

**GARAGE DOOR SILL & HEADER DETAIL
AT SIDING & 2" STONE VENEER**

EXTERIOR DOOR SCHEDULE

TAG	TYPE	FRAME WIDTH	FRAME HEIGHT	R.O. WIDTH	R.O. HEIGHT	SILL HEIGHT	HEAD HEIGHT	LEVEL	MANUFACTURER	ROOM NAME	ROOM #
D001	SLIDING DOOR	11' - 8 1/2"	7' - 10 1/2"	11' - 9 1/4"	7' - 10 7/8"	0" - 0"	7' - 10 1/2"	T/O SLAB - BASEMENT	Loewen	KIDS BEDROOM#1	006
D002	SLIDING DOOR	11' - 8 1/2"	7' - 10 1/2"	11' - 9 1/4"	7' - 10 7/8"	0" - 0"	7' - 10 1/2"	T/O SLAB - BASEMENT	Loewen	FAMILY ROOM	003
D003	SLIDING DOOR	11' - 8 1/2"	7' - 10 1/2"	11' - 9 1/4"	7' - 10 7/8"	0" - 0"	7' - 10 1/2"	T/O SLAB - BASEMENT	Loewen	2ND MASTER	001
D101	SINGLE DOOR	3' - 4 5/16"	7' - 10 1/2"	3' - 5 1/16"	7' - 10 7/8"	0" - 0"	7' - 10 1/2"	T/O SUBFLOOR - MAIN	Loewen	ENTRY	101
D102	SINGLE DOOR	3' - 0 3/8"	7' - 10 1/2"	3' - 1 1/8"	7' - 10 7/8"	0" - 0"	7' - 10 1/2"	T/O SUBFLOOR - MAIN	Loewen	COVERED PORCH	114
D103	SLIDING DOOR	11' - 8 1/2"	7' - 10 1/2"	11' - 9 1/4"	7' - 10 7/8"	0" - 0"	7' - 10 1/2"	T/O SUBFLOOR - MAIN	Loewen	DINING	103
D104	SLIDING DOOR	11' - 8 1/2"	7' - 10 1/2"	11' - 9 1/4"	7' - 10 7/8"	0" - 0"	7' - 10 1/2"	T/O SUBFLOOR - MAIN	Loewen	MASTER BEDROOM	106
D105	SINGLE DOOR	3' - 0 3/8"	7' - 2"	3' - 1 1/8"	7' - 2 3/8"	0" - 0"	7' - 2"	T/O SUBFLOOR - MAIN	Loewen	MUDROOM	109
D106	O.H. GARAGE DOOR	10' - 0"	9' - 0"	10' - 2"	9' - 1"	0" - 0"	9' - 0"	T/O SLAB - GARAGE	Loewen	GARAGE	113
D107	O.H. GARAGE DOOR	10' - 0"	9' - 0"	10' - 2"	9' - 1"	0" - 0"	9' - 0"	T/O SLAB - GARAGE	Loewen	GARAGE	113
D108	O.H. GARAGE DOOR	8' - 0"	8' - 0"	8' - 2"	8' - 1"	0" - 0"	8' - 0"	T/O SLAB - GARAGE	Loewen	GARAGE	113
D201	SLIDING DOOR	6' - 7 7/8"	7' - 10 1/2"	6' - 8 5/8"	7' - 10 7/8"	0" - 0"	7' - 10 1/2"	T/O SUBFLOOR - SECOND	Loewen	UPPER BEDROOM	201

EXTERIOR WINDOW SCHEDULE

TAG	TYPE	FRAME WIDTH	FRAME HEIGHT	R.O. WIDTH	R.O. HEIGHT	SILL HEIGHT	HEAD HEIGHT	LEVEL	MANUFACTURER	ROOM NAME	ROOM #
W001	Fixed	3' - 5 1/4"	2' - 7 1/2"	3' - 6"	2' - 8 1/4"	4' - 8"	7' - 3 1/2"	T/O SLAB - BASEMENT	Loewen	BATH	126
W002	Casement	3' - 5 1/4"	4' - 7 1/8"	3' - 6"	4' - 7 7/8"	3' - 3 3/8"	7' - 10 1/2"	T/O SLAB - BASEMENT	Loewen	KIDS BEDROOM#2	008
W003	Casement	3' - 5 1/4"	4' - 7 1/8"	3' - 6"	4' - 7 7/8"	3' - 3 3/8"	7' - 10 1/2"	T/O SLAB - BASEMENT	Loewen	KIDS BEDROOM#2	008
W004	Fixed	4' - 11 1/16"	2' - 7 1/2"	4' - 11 13/16"	2' - 8 1/4"	4' - 8"	7' - 3 1/2"	T/O SLAB - BASEMENT	Loewen	BATH	120
W005	Fixed	1' - 3 3/4"	7' - 10 1/2"	1' - 4 1/2"	7' - 11 1/4"	0" - 0"	7' - 10 1/2"	T/O SLAB - BASEMENT	Loewen	FAMILY ROOM	003
W006	Fixed	3' - 5 1/4"	2' - 7 1/2"	3' - 6"	2' - 8 1/4"	4' - 8"	7' - 3 1/2"	T/O SLAB - BASEMENT	Loewen	ENSUITE	122
W101	Fixed	1' - 7 11/16"	6' - 10 11/16"	1' - 8 7/16"	6' - 11 7/16"	0' - 11 13/16"	7' - 10 1/2"	T/O SUBFLOOR - MAIN	Loewen	ENTRY	101
W102	Fixed	5' - 0"	1' - 7 11/16"	5' - 0 3/4"	1' - 8 7/16"	7' - 10 1/2"	9' - 6 3/16"	T/O SUBFLOOR - MAIN	Loewen	ENTRY	101
W103	Casement	2' - 11 7/16"	4' - 7 1/8"	3' - 0 3/16"	4' - 7 7/8"	3' - 6"	8' - 1 1/8"	T/O SUBFLOOR - MAIN	Loewen	KITCHEN	104
W104	Fixed	2' - 11 7/16"	1' - 11 5/8"	3' - 0 3/16"	2' - 0 3/8"	8' - 1 1/8"	10' - 0 3/4"	T/O SUBFLOOR - MAIN	Loewen	KITCHEN	104
W105	Casement	2' - 11 7/16"	4' - 7 1/8"	3' - 0 3/16"	4' - 7 7/8"	3' - 6"	8' - 1 1/8"	T/O SUBFLOOR - MAIN	Loewen	KITCHEN	104
W106	Fixed	2' - 11 7/16"	1' - 11 5/8"	3' - 0 3/16"	2' - 0 3/8"	8' - 1 1/8"	10' - 0 3/4"	T/O SUBFLOOR - MAIN	Loewen	KITCHEN	104
W107	Casement	1' - 11 5/8"	3' - 11 1/4"	2' - 0 3/8"	4' - 0"	2' - 11 7/16"	6' - 10 11/16"	T/O SUBFLOOR - MAIN	Loewen	PANTRY	105
W108	Casement	1' - 11 5/8"	4' - 11 1/16"	2' - 0 3/8"	4' - 11 13/16"	2' - 11 7/16"	7' - 10 1/2"	T/O SUBFLOOR - MAIN	Loewen	DINING	103
W110	Fixed	2' - 11 7/32"	1' - 11 5/8"	2' - 11 31/32"	2' - 0 3/8"	8' - 10"	10' - 9 5/8"	T/O SUBFLOOR - MAIN	Loewen	DINING	103
W111	Fixed	4' - 11 1/16"	2' - 11 7/16"	4' - 11 13/16"	3' - 0 3/16"	8' - 10"	11' - 9 7/16"	T/O SUBFLOOR - MAIN	Loewen	DINING	103
W112	Fixed	2' - 11 7/32"	1' - 11 5/8"	2' - 11 31/32"	2' - 0 3/8"	8' - 10"	10' - 9 5/8"	T/O SUBFLOOR - MAIN	Loewen	DINING	103
W113	Fixed	3' - 11 1/4"	4' - 10 1/2"	4' - 0"	4' - 11 1/4"	3' - 0"	7' - 10 1/2"	T/O SUBFLOOR - MAIN	Loewen	DINING	103
W114	Awning	2' - 11 7/16"	1' - 7 11/16"	3' - 0 3/16"	1' - 8 7/16"	1' - 7 11/16"	3' - 3 3/8"	T/O SUBFLOOR - MAIN	Loewen	COVERED PORCH	114
W115	Fixed	2' - 11 7/16"	4' - 7 1/8"	3' - 0 3/16"	4' - 7 7/8"	3' - 3 3/8"	7' - 10 1/2"	T/O SUBFLOOR - MAIN	Loewen	COVERED PORCH	114
W116	Awning	3' - 3 3/8"	1' - 7 11/16"	3' - 4 1/8"	1' - 8 7/16"	1' - 7 11/16"	3' - 3 3/8"	T/O SUBFLOOR - MAIN	Loewen	GREAT ROOM	102
W117	Fixed	3' - 3 3/8"	4' - 7 1/8"	3' - 4 1/8"	4' - 7 7/8"	3' - 3 3/8"	7' - 10 1/2"	T/O SUBFLOOR - MAIN	Loewen	GREAT ROOM	102
W118	Fixed	6' - 10 11/16"	6' - 2 13/16"	6' - 11 7/16"	6' - 3 9/16"	1' - 7 11/16"	7' - 10 1/2"	T/O SUBFLOOR - MAIN	Loewen	GREAT ROOM	102
W119	Awning	3' - 3 3/8"	1' - 7 11/16"	3' - 4 1/8"	1' - 8 7/16"	1' - 7 11/16"	3' - 3 3/8"	T/O SUBFLOOR - MAIN	Loewen	GREAT ROOM	102
W120	Fixed	3' - 3 3/8"	4' - 7 1/8"	3' - 4 1/8"	4' - 7 7/8"	3' - 3 3/8"	7' - 10 1/2"	T/O SUBFLOOR - MAIN	Loewen	GREAT ROOM	102
W121	Fixed	3' - 3 3/8"	3' - 3 3/8"	3' - 4 1/8"	3' - 4 1/8"	8' - 10"	12' - 1 3/8"	T/O SUBFLOOR - MAIN	Loewen	GREAT ROOM	102
W122	Fixed	3' - 3 3/8"	1' - 7 11/16"	3' - 4 1/8"	1' - 8 7/16"	12' - 1 3/8"	13' - 9 1/16"	T/O SUBFLOOR - MAIN	Loewen	GREAT ROOM	102
W123	Fixed	6' - 10 11/16"	5' - 3"	6' - 11 7/16"	5' - 3 3/4"	8' - 10"	14' - 1"	T/O SUBFLOOR - MAIN	Loewen	GREAT ROOM	102
W125	Fixed	6' - 10 11/16"	1' - 7 11/16"	6' - 11 7/16"	1' - 8 7/16"	14' - 1"	15' - 8 11/16"	T/O SUBFLOOR - MAIN	Loewen	GREAT ROOM	102
W126	Fixed	3' - 3 3/8"	3' - 3 3/8"	3' - 4 1/8"	3' - 4 1/8"	8' - 10"	12' - 1 3/8"	T/O SUBFLOOR - MAIN	Loewen	GREAT ROOM	102
W127	Fixed	3' - 3 3/8"	1' - 7 11/16"	3' - 4 1/8"	1' - 8 7/16"	12' - 1 3/8"	13' - 9 1/16"	T/O SUBFLOOR - MAIN	Loewen	GREAT ROOM	102
W128	Fixed	1' - 3 3/4"	6' - 2 13/16"	1' - 4 1/2"	6' - 3 9/16"	1' - 7 11/16"	7' - 10 1/2"	T/O SUBFLOOR - MAIN	Loewen	GREAT ROOM	102
W129	Fixed	1' - 3 3/4"	4' - 11 1/16"	1' - 4 1/2"	4' - 11 13/16"	8' - 10"	13' - 9 1/16"	T/O SUBFLOOR - MAIN	Loewen	GREAT ROOM	102
W130	Fixed	2' - 11 7/32"	1' - 11 5/8"	2' - 11 31/32"	2' - 0 3/8"	8' - 10"	10' - 9 5/8"	T/O SUBFLOOR - MAIN	Loewen	MASTER BEDROOM	106
W131	Fixed	4' - 11 1/16"	2' - 11 7/16"	4' - 11 13/16"	3' - 0 3/16"	8' - 10"	11' - 9 7/16"	T/O SUBFLOOR - MAIN	Loewen	MASTER BEDROOM	106
W132	Fixed	2' - 11 7/32"	1' - 11 5/8"	2' - 11 31/32"	2' - 0 3/8"	8' - 10"	10' - 9 5/8"	T/O SUBFLOOR - MAIN	Loewen	MASTER BEDROOM	106
W133	Casement	2' - 11 7/16"	4' - 11 1/16"	3' - 0 3/16"	4' - 11 13/16"	2' - 11 7/16"	7' - 10 1/2"	T/O SUBFLOOR - MAIN	Loewen	MASTER BEDROOM	106
W134	Casement	2' - 11 7/16"	4' - 11 1/16"	3' - 0 3/16"	4' - 11 13/16"	2' - 11 7/16"	7' - 10 1/2"	T/O SUBFLOOR - MAIN	Loewen	MASTER BEDROOM	106
W135	Fixed	2' - 3 9/16"	1' - 9"	2' - 4 5/16"	1' - 9 3/4"	4' - 8"	6' - 5"	T/O SUBFLOOR - MAIN	Loewen	MASTER BATH	107
W136	Fixed	2' - 3 9/16"	1' - 9"	2' - 4 5/16"	1' - 9 3/4"	4' - 8"	6' - 5"	T/O SUBFLOOR - MAIN	Loewen	MASTER BATH	107
W137	Fixed	3' - 11 1/4"	4' - 5"	4' - 0"	4' - 5 3/4"	2' - 0"	6' - 5"	T/O SUBFLOOR - MAIN	Loewen	MASTER BATH	107
W138	Casement	1' - 11 5/8"	1' - 11 5/8"	2' - 0 3/8"	2' - 0 3/8"	5' - 11 7/16"	7' - 11 1/16"	T/O SUBFLOOR - MAIN	Loewen	MASTER BATH	107
W139	Fixed	1' - 11 5/8"	1' - 11 5/8"	2' - 0 3/8"	2' - 0 3/8"	5' - 11 7/16"	7' - 11 1/16"	T/O SUBFLOOR - MAIN	Loewen	MASTER BATH	107
W140	Casement	1' - 11 5/8"	1' - 11 5/8"	2' - 0 3/8"	2' - 0 3/8"	5' - 11 7/16"	7' - 11 1/16"	T/O SUBFLOOR - MAIN	Loewen	MASTER BATH	107
W141	Casement	2' - 5 1/2"	4' - 11 1/16"	2' - 6 1/4"	4' - 11 13/16"	2' - 11 7/16"	7' - 10 1/2"	T/O SUBFLOOR - MAIN	Loewen	LAUNDRY	123
W142	Casement	2' - 5 1/2"	2' - 11 7/16"	2' - 6 1/4"	3' - 0 3/16"	4' - 7 9/16"	7' - 7"	T/O SLAB - GARAGE	Loewen	GARAGE	113
W143	Casement	2' - 5 1/2"	2' - 11 7/16"	2' - 6 1/4"	3' - 0 3/16"	4' - 7 9/16"	7' - 7"	T/O SLAB - GARAGE	Loewen	GARAGE	113
W144	Casement	2' - 5 1/2"	2' - 11 7/16"	2' - 6 1/4"	3' - 0 3/16"	4' - 7 9/16"	7' - 7"	T/O SLAB - GARAGE	Loewen	GARAGE	113
W145	Casement	2' - 5 1/2"	2' - 11 7/16"	2' - 6 1/4"	3' - 0 3/16"	4' - 7 9/16"	7' - 7"	T/O SLAB - GARAGE	Loewen	GARAGE	113
W146	Fixed	2' - 5 1/2"	2' - 11 7/16"	2' - 6 1/4"	3' - 0 3/16"	4' - 7 9/16"	7' - 7"	T/O SLAB - GARAGE	Loewen	GARAGE	113
W147	Casement	2' - 5 1/2"	2' - 11 7/16"	2' - 6 1/4"	3' - 0 3/16"	4' - 7 9/16"	7' - 7"	T/O SLAB - GARAGE	Loewen	GARAGE	113
W148	Fixed	3' - 11 1/4"	1' - 11 5/8"	4' - 0"	2' - 0 3/8"	5' - 2 3/8"	7' - 2"	T/O SUBFLOOR - MAIN	Loewen	MUDROOM	109
W201	Casement	2' - 5 1/2"	2' - 11 7/16"	2' - 6 1/4"	3' - 0 3/16"	3' - 11 5/8"	6' - 11 1/16"	T/O SUBFLOOR - SECOND	Loewen	UPPER BATH	202
W202	Fixed	2' - 11 7/16"	4' - 11 1/16"	3' - 0 3/16"	4' - 11 13/16"	0' - 4"	5' - 3 1/16"	T/O SUBFLOOR - SECOND	Loewen	MUDROOM	109



P.O. BOX 1665
GOLDEN, BRITISH COLUMBIA, CANADA
V0A 1H0

OFFICE: (250) 348-2231
FAX: (250) 348-2244
WEB: WWW.CANADIANTIMBERFRAMES.COM

WINDOW & DOOR SCHEDULE & DETAILS

**MOODY RESIDENCE
20130
2021-05-25 12:48:45 PM**

ISSUED FOR: DRB REVIEW

THESE DRAWINGS ARE THE PROPERTY OF CANADIAN TIMBERFRAMES LTD. AND MAY NOT BE REPRODUCED OR COPIED WITHOUT OUR WRITTEN CONSENT. ALL DESIGNS, IDEAS, AND CONCEPTS DEVELOPED IN THIS DRAWING SHALL REMAIN AT ALL TIMES THE SOLE PROPERTY OF CANADIAN TIMBERFRAMES LTD.