

**TOWN OF MOUNTAIN VILLAGE  
BOARD OF APPEALS HEARING AGENDA  
TO BE HELD VIA ZOOM  
THURSDAY SEPTEMBER 21, 2021, 3:00 PM  
MOUNTAIN VILLAGE TOWN HALL  
455 MOUNTAIN VILLAGE BLVD, MOUNTAIN VILLAGE, COLORADO  
MOUNTAIN VILLAGE TOWN HALL**

|    | Time | Min. | Presenter                                    | Type    |                                                                                                                                                                                                                                                                                                                                                                             |
|----|------|------|----------------------------------------------|---------|-----------------------------------------------------------------------------------------------------------------------------------------------------------------------------------------------------------------------------------------------------------------------------------------------------------------------------------------------------------------------------|
| 1. | 3:00 |      | Chair                                        |         | Call to Order                                                                                                                                                                                                                                                                                                                                                               |
| 2. | 3:00 | 60   | Haynes/<br>Harrington<br>Wisor/Applica<br>nt | Hearing | An appeal to the building official decision specific to Unit GL-101, See Forever Village at the Peaks, building permit 2017-MVL-00056. The CO and TCO required fireproofing the garage structural beams and columns triggered by the unit change of use. The TCO was extended until such time a BOA hearing could be convened. The TCO otherwise expired on April 15, 2018. |
| 3. | 4:00 |      | Chair                                        |         | Adjourn                                                                                                                                                                                                                                                                                                                                                                     |

TMV Planning is inviting you to a scheduled Zoom meeting.

Join Zoom Meeting

<https://us02web.zoom.us/j/82729878467?pwd=UzhMSWNCeINqTENoUWpVSkxBQVhIzZ09>

Meeting ID: 827 2987 8467

Passcode: 234918

One tap mobile

+13462487799,,82729878467#,,,,\*234918# US (Houston)

+16699009128,,82729878467#,,,,\*234918# US (San Jose)

Dial by your location

+1 346 248 7799 US (Houston)

+1 669 900 9128 US (San Jose)

+1 253 215 8782 US (Tacoma)

+1 312 626 6799 US (Chicago)

+1 646 558 8656 US (New York)

+1 301 715 8592 US (Washington DC)

Meeting ID: 827 2987 8467

Passcode: 234918

Find your local number: <https://us02web.zoom.us/j/82729878467?pwd=UzhMSWNCeINqTENoUWpVSkxBQVhIzZ09>

Please note that this Agenda is subject to change. (Times are approximate and subject to change)

455 Mountain Village Blvd., Suite A, Mountain Village, Colorado 81435

Phone: (970) 369-8242

Fax: (970) 728-4342

Individuals with disabilities needing auxiliary aid(s) may request assistance by contacting Town Hall at the above numbers or email: [cd@mtnvillage.org](mailto:cd@mtnvillage.org). We would appreciate it if you would contact us at least 48 hours in advance of the scheduled event so arrangements can be made to locate requested auxiliary aid(s).



**TO:** Board of Adjustments (BOA), Town of Mountain Village

**FROM:** Drew Harrington, Building Official, Michelle Haynes, Planning and Development Services Director

**FOR:** September 21, 2021 Meeting Date

**DATE:** September 6, 2021

**RE:** An appeal to the building official decision specific to Unit GL-101, See Forever Village at the Peaks, building permit 2017-MVL-00056. The Certificate of Occupancy (CO) and Temporary Certificate of Occupancy (TCO) required fireproofing the garage structural beams and columns triggered by the unit change of use. The TCO was extended until such time a BOA hearing could be convened. The TCO otherwise expired on April 15, 2018.

---

**OVERVIEW**

A Planned Unit Development amendment and rezone and density transfer was approved by Town Council in 2017 to convert See Forever commercial space to a residential unit. A building permit was issued in 2017, shortly thereafter, for the conversion of commercial space to residential space. As part of the change of use, one of the building conditions of approval of the building permit was that the owner needed to provide adequate fire protection between the residential unit and the parking garage beneath the unit. This requirement carried over as a condition for the issuance of the temporary certificate of occupancy that was issued for the unit that subsequently expired on April 15, 2018.

The In order to satisfy the condition, the owner sought out a 3<sup>rd</sup> party code consultant to determine whether the fire protection condition was necessary. The third party consultant provided a letter to the town.

The Building Official, after having reviewed the 3<sup>rd</sup> party consultant letter, did not change the fire proofing requirement outlined in the building permit. That decision was provided to the owner on September 30, 2021. The owner's attorney filed an appeal to the decision allowable per the CDC.

The town entered into an agreement with the owner to allow a TCO to carry forward on the property until such time we could schedule an in-person BOA meeting due to covid. In order to address meeting challenges during an enduring pandemic and accommodate schedules, parties agreed to a virtual BOA hearing.

The primary rationale set forth by the owner for failure to meet the condition is that the See Forever garage did not receive the necessary fire protection at the time of

construction. Therefore, they feel that this requirement is not addressing the larger lack of protection afforded in the garage today and from a practical perspective, otherwise seems ineffective to require it considering the condition of the garage.

When the See Forever garage was originally constructed fire sprinkling occurred per the note called "additional requirements" (see page 10 of the packet, the note is clouded on the original building permit plan set) however the structural beams and columns were not individually protected per the note. The Town has had two fire marshals subsequent to the mid-2000's verify that this requirement did not occur. The HOA and Town are now aware of the larger issue. For the purposes of this hearing, although the context is important, the deliberations need to be confined to the specific requirement triggered by the change of use of the commercial unit to residential use.

The town's perspective is that in the application of the building code, we always strive to incrementally improve and make safer, rather than make things less safe or more non-conforming. Requiring fire protection directly beneath this unit provides the unit more protection than ignoring the code provision.

### **ATTACHMENTS**

- A. Appeal Filing J. Solomon dated 10.3.2019
- B. Applicant Additional Information dated 10.3.2019
  1. Email from S. Lawshe
  2. Email from Nictakis
- C. Temporary Certificate of Occupancy
- D. Agreement
  1. 1<sup>st</sup> amendment to the agreement
- E. Colorado Code Consultant Letter dated 8.12.2019
- F. Harrington Response to the Colorado Code Consultant letter dated 8.20.19
- G. Building Permit Redlined Plans from Building Official
- H. Building Code citations
- I. Additional code fire separation materials

### **PRIOR APPROVALS AND DEVELOPMENT HISTORY**

1. Ordinance No. 2017-02 recorded on April 3, 2017
  - a. The Town approved a Planned Unit Development amended for the conversation of commercial space to a residential condominium
2. Building Permit Issued in 2017
  - a. Permit No. 2017-MVL-00056, for the conversation of the commercial space to a residential unit.
3. TCO was issued on December 27, 2017
  - a. expired on April 15, 2018
4. Condominium Map
  - a. Recorded in 2018 to memorialized as-built conditions on September 18, 2018 at reception No. 454848 consistent with the PUD approvals.
5. 3<sup>rd</sup> party code opinion provided by Mr. Steve Thomas, Colorado Code Consulting via email on August 12, 2019
6. A written decision provided by D. Harrington regarding the garage ceiling fire protection provided on September 20, 2019 (then again on September 30, 2019)(Dated August 20, 2019)
7. October 3, 2019, an Appeal to the Building Official decision was filed.
8. Agreement executed to extend the TCO until a BOA hearing could be scheduled.
  - a. First Amended Agreement due to Covid.

## **PURPOSE AND OBJECTIVE**

The BOA must weigh the materials provided at the hearing and testimony and decide whether to uphold the building official's decision or to overturn the building official's decision.

## **PROCESS**

The BOA follows the meeting procedures outlined in Robert's Rules of Order. The process is as follows:

1. Town staff/attorney introduces the item
  - a. BOA asks questions of staff
2. The appellant presents their case
  - a. BOA asks questions of the appellant
3. BOA opens for public comment
4. BOA chairperson closes public comment
5. BOA deliberates
6. BOA makes a decision by motion

## **RECOMMENDED MOTION**

### Option #1

*I move to support the Building Officials decision that fire protection is necessary in the garage and directly beneath the residential unit. This requirement needs to be addressed within a six month timeframe inclusive of passing all required inspections in order for the unit to receive a Certificate of Occupancy.*

1. A condition of PUD approval includes that the unit once CO'd must be made available in the short-term rental pool administered by See Forever.
2. A condition of the building permit required an encroachment agreement be executed for a retaining wall constructed in town open space.

### Option #2

*I move to overturn the Building Officials decision that fire protection is necessary in the garage and directly beneath the residential unit. Given that all other building conditions and final inspections pass and are met, the Building Official will otherwise be able to issue a Certificate of Occupancy.*

1. A condition of PUD approval includes that the unit once CO'd must be made available in the See Forever rental pool creating an additional hot bed consistent with the PUD amendment ordinance.
2. A condition of the building permit required an encroachment agreement be executed for a retaining wall constructed in town open space.

/mbh





**SOLOMON LAW FIRM, P.C.**

227 WEST PACIFIC AVENUE, SUITE A (REQUIRED FOR FEDEX)  
PO BOX 1748 (REQUIRED FOR ALL U.S. MAIL)

JOSEPH A. SOLOMON, ESQ. TELLURIDE, COLORADO 81435  
ATTORNEY AT LAW  
E-MAIL: JSOLOMON@MONTROSE.NET

TEL (970) 728-8655  
CELL (970) 729-2225  
FAX (775) 703-9582

October 3, 2019

Mountain Village Building Board of Appeals  
Town of Mountain Village  
455 Mountain Village Boulevard, Suite A  
Mountain Village, Colorado 81435

Via E-mail to:

Town Building Official Drew Harrington at: Dharrington@mtnvillage.org  
Town Clerk Jackie Kennefick at: JKennefick@mtnvillage.org

Re: See Forever Village at The Peaks, Unit GL101  
Appeal of Building Official Determination

Dear Mountain Village Building Board of Appeals:

I represent SFV Mountain View, LLC ("**Mountain View**"), Dan Reedy, Manager, owner of See Forever Village at The Peaks, Unit GL101.

The purpose of this letter is to appeal the determination of Town Building Official Drew Harrington concerning his determination that Mountain View must apply fire-resistant material to the structural beams and columns below Unit GL101 in the parking structure.

**Background**

See Forever Village at The Peaks is a condominium community established in December 2005.

The original project contemplated that certain unfinished ground floor space would be finished out and used as a restaurant. The project contained a deed restriction to this effect, signed for the benefit of the Town and TSG Ski & Golf Company ("**TSG**"). However, despite efforts, the developer was unable to locate a restaurant operator interested in purchasing and finishing out the space.

As such, in 2016, the developer began exploring with the Town and TSG the possibility of converting the unfinished space to a Residential Unit. Receiving positive feedback, in August 2016, the developer sold the space to Mountain View.

Mountain View then successfully processed an application with the Town to amend the PUD and convert the space to Residential Unit GL101. The application was approved in April 2017.

Mountain View finished out the space, completing the work in January 2018. A Temporary Certificate of Occupancy was issued. See Documents Package, document Mountain View - 4.

### **Unit GL101**

Unit GL101 was issued a temporary certificate of occupancy.

The Town indicated that it would issue a final certificate of occupancy provided Mountain View apply fire-resistant material to the structural beams and columns below Unit GL101 in the parking structure.

Mountain View conferred with Town Building Official Drew Harrington regarding the matter. Enclosed is the correspondence with Mr. Herrington.

As part of its conferral with Mr. Herrington, Mountain View retained Steve Thomas of Colorado Code Consulting, LLC to provide a written opinion concerning the requirement. Enclosed as document Mountain View 6-8 is a copy of Mr. Thomas' August 12, 2019 letter.

As set forth in Mr. Thomas' letter, the structural frame is not required to be provided with any fire protection per Table 601. The IBC requires that the R-2 residential occupancy be separated from the S-2 parking garage by a one-hour occupancy separation per Table 508.4. The existing concrete floor assembly will provide that level of protection per Table 721.1(3), Item 1-1.1. Therefore, the occupancy separation is provided at the floor and wall surfaces.

Although Section 711.4 requires that the structure supporting the horizontal assembly to be protected at the same level as the floor assembly (one-hour), this protection was not required when the building was originally constructed.

Rather, and as shown on the original plans, the . See the page 1 of the original plans, included as documents Mountain View 2-3. Page 3 is a blowup of the note on page 1, which states:

### **ADDITIONAL REQUIREMENTS:**

**AN APPROVED AUTOMATIC SPRINKLER SYSTEM IS REQUIRED TO BE  
INSTALLED IN ACCORDANCE WITH SECTION 903.3.11 OF THE 2000 IBC.**

**STRUCTURAL BEAMS & COLUMNS ARE TO BE INDIVIDUALLY  
FIRE PROTECTED WITH AN AUTOMATIC SPRINKLER SYSTEM  
IN ACCORDANCE WITH SECTION 903.3.11 OF THE IBC.**

The whole parking garage under the San Sophia and Mount Wilson Buildings received a separate final certificate of occupancy in 2007.

As explained by Mr. Thomas, the existing steel in the garage is unprotected throughout the garage as originally approved, and in order to go back and install additional protection, it would

require the removal of ducts, plumbing, electrical, walls and other systems.

Mr. Thomas proposes that the Town accept IBC Section 3408.1, which states in part that the use of existing buildings may change without conforming to all code requirements provided the new use is less hazardous, based on life and fire risk, than the existing use. As explained by Mr. Thomas, the new Group R-2 (residential) occupancy is less hazardous than the previously approved Group A-2 (restaurant) occupancy.

### **September 18, 2019 Meeting and Subsequent Correspondence**

On September 18, 2019, Mr. Reedy then met with Mr. Harrington on site, along with See Forever Engineer Scott Lawshe. The parties reviewed the issue.

Thereafter, at Mr. Reedy's request, Mr. Harrington provided copies of the code sections he was referencing. See documents Mountain View 10-13.

On September 30, 2019, Mr. Reedy asked Mr. Harrington for a written decision. Mr. Harrington responded and included a copy of a letter dated August 20, 2019. However, as stated, Mr. Reedy did not receive the August 20, 2019 letter. The first time Mr. Reedy saw the August 20, 2019 letter was when it was E-mailed to him on September 30, 2019. See documents Mountain View 14-17.

### **Conclusion**

Mountain View requests a hearing before the Mountain Village Building Board of Appeals.

Thank you for your consideration of this appeal.

Sincerely,

A handwritten signature in black ink, appearing to read "Joseph A. Solomon", written over a horizontal line.

Joseph A. Solomon, Esq.

Enc. (Documents Package)

cc:

Dan Reedy, Manager, SFV Mountain View, LLC  
F. John Abrams, President, See Forever Village at The Peaks Homeowners Association, Inc.  
Jeffrey Gibson, Director, See Forever Village at The Peaks Homeowners Association, Inc.  
David Eckman, Eckman Consulting & Management  
Stephen L. Thomas, President, Colorado Code Consulting, LLC

SFV Mountain View, LLC / Unit GL101  
Mountain Village Building Board of Appeals  
Documents Package Index

20060216 SFV Plans p. 1 w blowup

20180115 TCO\_117\_Sunny\_Ridge

20190812 E-mail CCC to DH w ltr

20190918 E-mail DR to DH

20190918 E-mails DH-DR w encs

20190930 E-mails DH-DR w 8-20-19 ltr

project data

**BUILDING CODE**  
 INTERNATIONAL BUILDING CODE 2000 EDITION  
 UNIFORM ELECTRICAL CODE 2000 EDITION  
 UNIFORM MECHANICAL CODE 2000 EDITION  
 UNIFORM PLUMBING CODE 2000 EDITION  
 UNIFORM FIRE CODE 98 EDITION

**OCCUPANCY GROUP**  
 THIRD, R-1 RESIDENTIAL  
 R-2 (PARKING GARAGE)  
 R-1 (RESIDENTIAL)  
 R-2 (RESTAURANT)

**REQUIRED SEPARATIONS**  
 FROM R-2 TO R-2 + 0 AND  
 FROM R-2 TO R-1 + 0 AND  
 FROM R-2 TO R-2 + 1 AND  
 FROM R-2 TO R-1 + 1 AND

**CONSTRUCTION TYPE**  
 TYPE III FULLY SPRINKLERED  
 ABOVE TABLE 5-2 TO R-2 2 AND HORIZONTAL ASSEMBLY

**ADDITIONAL REQUIREMENTS**  
 AN APPROVED AUTOMATIC SPRINKLER SYSTEM IS REQUIRED TO BE INSTALLED IN ACCORDANCE WITH SECTION 904 (SECTION 907) OF THE CODE BOOK

**ADDITIONAL REQUIREMENTS**  
 STRUCTURAL BEAMS / COLUMNS ARE TO BE INDIVIDUALLY FIRE PROTECTED WITH AN AUTOMATIC SPRINKLER SYSTEM IN ACCORDANCE WITH SECTION 907(1) OF THE CODE BOOK

area analysis

|              |             |        |
|--------------|-------------|--------|
| SEARCH LEVEL | GRADE (MSL) | 0.0000 |
| LEVEL 1      | GRADE (MSL) | 0.0000 |
| LEVEL 2      | GRADE (MSL) | 0.0000 |
| LEVEL 3      | GRADE (MSL) | 0.0000 |
| LEVEL 4      | GRADE (MSL) | 0.0000 |
| LEVEL 5      | GRADE (MSL) | 0.0000 |
| LEVEL 6      | GRADE (MSL) | 0.0000 |
| LEVEL 7      | GRADE (MSL) | 0.0000 |
| LEVEL 8      | GRADE (MSL) | 0.0000 |
| LEVEL 9      | GRADE (MSL) | 0.0000 |
| LEVEL 10     | GRADE (MSL) | 0.0000 |
| LEVEL 11     | GRADE (MSL) | 0.0000 |
| LEVEL 12     | GRADE (MSL) | 0.0000 |
| LEVEL 13     | GRADE (MSL) | 0.0000 |
| LEVEL 14     | GRADE (MSL) | 0.0000 |
| LEVEL 15     | GRADE (MSL) | 0.0000 |
| LEVEL 16     | GRADE (MSL) | 0.0000 |
| LEVEL 17     | GRADE (MSL) | 0.0000 |
| LEVEL 18     | GRADE (MSL) | 0.0000 |
| LEVEL 19     | GRADE (MSL) | 0.0000 |
| LEVEL 20     | GRADE (MSL) | 0.0000 |
| LEVEL 21     | GRADE (MSL) | 0.0000 |
| LEVEL 22     | GRADE (MSL) | 0.0000 |
| LEVEL 23     | GRADE (MSL) | 0.0000 |
| LEVEL 24     | GRADE (MSL) | 0.0000 |
| LEVEL 25     | GRADE (MSL) | 0.0000 |
| LEVEL 26     | GRADE (MSL) | 0.0000 |
| LEVEL 27     | GRADE (MSL) | 0.0000 |
| LEVEL 28     | GRADE (MSL) | 0.0000 |
| LEVEL 29     | GRADE (MSL) | 0.0000 |
| LEVEL 30     | GRADE (MSL) | 0.0000 |
| LEVEL 31     | GRADE (MSL) | 0.0000 |
| LEVEL 32     | GRADE (MSL) | 0.0000 |
| LEVEL 33     | GRADE (MSL) | 0.0000 |
| LEVEL 34     | GRADE (MSL) | 0.0000 |
| LEVEL 35     | GRADE (MSL) | 0.0000 |
| LEVEL 36     | GRADE (MSL) | 0.0000 |
| LEVEL 37     | GRADE (MSL) | 0.0000 |
| LEVEL 38     | GRADE (MSL) | 0.0000 |
| LEVEL 39     | GRADE (MSL) | 0.0000 |
| LEVEL 40     | GRADE (MSL) | 0.0000 |
| LEVEL 41     | GRADE (MSL) | 0.0000 |
| LEVEL 42     | GRADE (MSL) | 0.0000 |
| LEVEL 43     | GRADE (MSL) | 0.0000 |
| LEVEL 44     | GRADE (MSL) | 0.0000 |
| LEVEL 45     | GRADE (MSL) | 0.0000 |
| LEVEL 46     | GRADE (MSL) | 0.0000 |
| LEVEL 47     | GRADE (MSL) | 0.0000 |
| LEVEL 48     | GRADE (MSL) | 0.0000 |
| LEVEL 49     | GRADE (MSL) | 0.0000 |
| LEVEL 50     | GRADE (MSL) | 0.0000 |
| LEVEL 51     | GRADE (MSL) | 0.0000 |
| LEVEL 52     | GRADE (MSL) | 0.0000 |
| LEVEL 53     | GRADE (MSL) | 0.0000 |
| LEVEL 54     | GRADE (MSL) | 0.0000 |
| LEVEL 55     | GRADE (MSL) | 0.0000 |
| LEVEL 56     | GRADE (MSL) | 0.0000 |
| LEVEL 57     | GRADE (MSL) | 0.0000 |
| LEVEL 58     | GRADE (MSL) | 0.0000 |
| LEVEL 59     | GRADE (MSL) | 0.0000 |
| LEVEL 60     | GRADE (MSL) | 0.0000 |
| LEVEL 61     | GRADE (MSL) | 0.0000 |
| LEVEL 62     | GRADE (MSL) | 0.0000 |
| LEVEL 63     | GRADE (MSL) | 0.0000 |
| LEVEL 64     | GRADE (MSL) | 0.0000 |
| LEVEL 65     | GRADE (MSL) | 0.0000 |
| LEVEL 66     | GRADE (MSL) | 0.0000 |
| LEVEL 67     | GRADE (MSL) | 0.0000 |
| LEVEL 68     | GRADE (MSL) | 0.0000 |
| LEVEL 69     | GRADE (MSL) | 0.0000 |
| LEVEL 70     | GRADE (MSL) | 0.0000 |
| LEVEL 71     | GRADE (MSL) | 0.0000 |
| LEVEL 72     | GRADE (MSL) | 0.0000 |
| LEVEL 73     | GRADE (MSL) | 0.0000 |
| LEVEL 74     | GRADE (MSL) | 0.0000 |
| LEVEL 75     | GRADE (MSL) | 0.0000 |
| LEVEL 76     | GRADE (MSL) | 0.0000 |
| LEVEL 77     | GRADE (MSL) | 0.0000 |
| LEVEL 78     | GRADE (MSL) | 0.0000 |
| LEVEL 79     | GRADE (MSL) | 0.0000 |
| LEVEL 80     | GRADE (MSL) | 0.0000 |
| LEVEL 81     | GRADE (MSL) | 0.0000 |
| LEVEL 82     | GRADE (MSL) | 0.0000 |
| LEVEL 83     | GRADE (MSL) | 0.0000 |
| LEVEL 84     | GRADE (MSL) | 0.0000 |
| LEVEL 85     | GRADE (MSL) | 0.0000 |
| LEVEL 86     | GRADE (MSL) | 0.0000 |
| LEVEL 87     | GRADE (MSL) | 0.0000 |
| LEVEL 88     | GRADE (MSL) | 0.0000 |
| LEVEL 89     | GRADE (MSL) | 0.0000 |
| LEVEL 90     | GRADE (MSL) | 0.0000 |
| LEVEL 91     | GRADE (MSL) | 0.0000 |
| LEVEL 92     | GRADE (MSL) | 0.0000 |
| LEVEL 93     | GRADE (MSL) | 0.0000 |
| LEVEL 94     | GRADE (MSL) | 0.0000 |
| LEVEL 95     | GRADE (MSL) | 0.0000 |
| LEVEL 96     | GRADE (MSL) | 0.0000 |
| LEVEL 97     | GRADE (MSL) | 0.0000 |
| LEVEL 98     | GRADE (MSL) | 0.0000 |
| LEVEL 99     | GRADE (MSL) | 0.0000 |
| LEVEL 100    | GRADE (MSL) | 0.0000 |

# SEE FOREVER VILLAGE BUILDING A TELLURIDE, COLORADO



See Forever Village



|                                                                                                                                                       |                                                                                                                                                                        |                                                                                                                                                                                  |                                                                                                                                                                              |                                                                                                                                                  |                                                                                                                                                           |
|-------------------------------------------------------------------------------------------------------------------------------------------------------|------------------------------------------------------------------------------------------------------------------------------------------------------------------------|----------------------------------------------------------------------------------------------------------------------------------------------------------------------------------|------------------------------------------------------------------------------------------------------------------------------------------------------------------------------|--------------------------------------------------------------------------------------------------------------------------------------------------|-----------------------------------------------------------------------------------------------------------------------------------------------------------|
| <b>OWNER/DEVELOPER</b><br>SUNNY RIDGE PLACE<br>200 N. MAIN ST.<br>TELLURIDE, CO 81415<br>TEL: 719-726-1111<br>FAX: 719-726-1112<br>WWW.SUNNYRIDGE.COM | <b>ARCHITECT</b><br>JAMES H. HARRIS ARCHITECTS<br>100 N. MAIN ST., SUITE 100<br>TELLURIDE, CO 81415<br>TEL: 719-726-1111<br>FAX: 719-726-1112<br>WWW.JHHARCHITECTS.COM | <b>STRUCTURAL ENGINEER</b><br>JAMES H. HARRIS ARCHITECTS<br>100 N. MAIN ST., SUITE 100<br>TELLURIDE, CO 81415<br>TEL: 719-726-1111<br>FAX: 719-726-1112<br>WWW.JHHARCHITECTS.COM | <b>INTERIOR DESIGN</b><br>JAMES H. HARRIS ARCHITECTS<br>100 N. MAIN ST., SUITE 100<br>TELLURIDE, CO 81415<br>TEL: 719-726-1111<br>FAX: 719-726-1112<br>WWW.JHHARCHITECTS.COM | <b>ELECTRICAL</b><br>SUNNY RIDGE PLACE<br>200 N. MAIN ST.<br>TELLURIDE, CO 81415<br>TEL: 719-726-1111<br>FAX: 719-726-1112<br>WWW.SUNNYRIDGE.COM | <b>MECHANICAL/PLUMBING</b><br>SUNNY RIDGE PLACE<br>200 N. MAIN ST.<br>TELLURIDE, CO 81415<br>TEL: 719-726-1111<br>FAX: 719-726-1112<br>WWW.SUNNYRIDGE.COM |
|-------------------------------------------------------------------------------------------------------------------------------------------------------|------------------------------------------------------------------------------------------------------------------------------------------------------------------------|----------------------------------------------------------------------------------------------------------------------------------------------------------------------------------|------------------------------------------------------------------------------------------------------------------------------------------------------------------------------|--------------------------------------------------------------------------------------------------------------------------------------------------|-----------------------------------------------------------------------------------------------------------------------------------------------------------|

index

|     |     |     |     |     |     |     |     |     |     |     |     |     |     |     |     |     |     |     |     |     |     |     |     |     |     |     |     |     |     |     |     |     |     |     |     |     |     |     |     |     |     |     |     |     |     |     |     |     |     |     |     |     |     |     |     |     |     |     |     |     |     |     |     |     |     |     |     |     |     |     |     |     |     |     |     |     |     |     |     |     |     |     |     |     |     |     |     |     |     |     |     |     |     |     |     |     |     |     |     |
|-----|-----|-----|-----|-----|-----|-----|-----|-----|-----|-----|-----|-----|-----|-----|-----|-----|-----|-----|-----|-----|-----|-----|-----|-----|-----|-----|-----|-----|-----|-----|-----|-----|-----|-----|-----|-----|-----|-----|-----|-----|-----|-----|-----|-----|-----|-----|-----|-----|-----|-----|-----|-----|-----|-----|-----|-----|-----|-----|-----|-----|-----|-----|-----|-----|-----|-----|-----|-----|-----|-----|-----|-----|-----|-----|-----|-----|-----|-----|-----|-----|-----|-----|-----|-----|-----|-----|-----|-----|-----|-----|-----|-----|-----|-----|-----|-----|-----|-----|-----|
| 101 | 102 | 103 | 104 | 105 | 106 | 107 | 108 | 109 | 110 | 111 | 112 | 113 | 114 | 115 | 116 | 117 | 118 | 119 | 120 | 121 | 122 | 123 | 124 | 125 | 126 | 127 | 128 | 129 | 130 | 131 | 132 | 133 | 134 | 135 | 136 | 137 | 138 | 139 | 140 | 141 | 142 | 143 | 144 | 145 | 146 | 147 | 148 | 149 | 150 | 151 | 152 | 153 | 154 | 155 | 156 | 157 | 158 | 159 | 160 | 161 | 162 | 163 | 164 | 165 | 166 | 167 | 168 | 169 | 170 | 171 | 172 | 173 | 174 | 175 | 176 | 177 | 178 | 179 | 180 | 181 | 182 | 183 | 184 | 185 | 186 | 187 | 188 | 189 | 190 | 191 | 192 | 193 | 194 | 195 | 196 | 197 | 198 | 199 | 200 |
|-----|-----|-----|-----|-----|-----|-----|-----|-----|-----|-----|-----|-----|-----|-----|-----|-----|-----|-----|-----|-----|-----|-----|-----|-----|-----|-----|-----|-----|-----|-----|-----|-----|-----|-----|-----|-----|-----|-----|-----|-----|-----|-----|-----|-----|-----|-----|-----|-----|-----|-----|-----|-----|-----|-----|-----|-----|-----|-----|-----|-----|-----|-----|-----|-----|-----|-----|-----|-----|-----|-----|-----|-----|-----|-----|-----|-----|-----|-----|-----|-----|-----|-----|-----|-----|-----|-----|-----|-----|-----|-----|-----|-----|-----|-----|-----|-----|-----|-----|-----|

abbreviations

|     |     |     |     |     |     |     |     |     |     |     |     |     |     |     |     |     |     |     |     |     |     |     |     |     |     |     |     |     |     |     |     |     |     |     |     |     |     |     |     |     |     |     |     |     |     |     |     |     |     |     |     |     |     |     |     |     |     |     |     |     |     |     |     |     |     |     |     |     |     |     |     |     |     |     |     |     |     |     |     |     |     |     |     |     |     |     |     |     |     |     |     |     |     |     |     |     |     |     |     |
|-----|-----|-----|-----|-----|-----|-----|-----|-----|-----|-----|-----|-----|-----|-----|-----|-----|-----|-----|-----|-----|-----|-----|-----|-----|-----|-----|-----|-----|-----|-----|-----|-----|-----|-----|-----|-----|-----|-----|-----|-----|-----|-----|-----|-----|-----|-----|-----|-----|-----|-----|-----|-----|-----|-----|-----|-----|-----|-----|-----|-----|-----|-----|-----|-----|-----|-----|-----|-----|-----|-----|-----|-----|-----|-----|-----|-----|-----|-----|-----|-----|-----|-----|-----|-----|-----|-----|-----|-----|-----|-----|-----|-----|-----|-----|-----|-----|-----|-----|-----|
| 101 | 102 | 103 | 104 | 105 | 106 | 107 | 108 | 109 | 110 | 111 | 112 | 113 | 114 | 115 | 116 | 117 | 118 | 119 | 120 | 121 | 122 | 123 | 124 | 125 | 126 | 127 | 128 | 129 | 130 | 131 | 132 | 133 | 134 | 135 | 136 | 137 | 138 | 139 | 140 | 141 | 142 | 143 | 144 | 145 | 146 | 147 | 148 | 149 | 150 | 151 | 152 | 153 | 154 | 155 | 156 | 157 | 158 | 159 | 160 | 161 | 162 | 163 | 164 | 165 | 166 | 167 | 168 | 169 | 170 | 171 | 172 | 173 | 174 | 175 | 176 | 177 | 178 | 179 | 180 | 181 | 182 | 183 | 184 | 185 | 186 | 187 | 188 | 189 | 190 | 191 | 192 | 193 | 194 | 195 | 196 | 197 | 198 | 199 | 200 |
|-----|-----|-----|-----|-----|-----|-----|-----|-----|-----|-----|-----|-----|-----|-----|-----|-----|-----|-----|-----|-----|-----|-----|-----|-----|-----|-----|-----|-----|-----|-----|-----|-----|-----|-----|-----|-----|-----|-----|-----|-----|-----|-----|-----|-----|-----|-----|-----|-----|-----|-----|-----|-----|-----|-----|-----|-----|-----|-----|-----|-----|-----|-----|-----|-----|-----|-----|-----|-----|-----|-----|-----|-----|-----|-----|-----|-----|-----|-----|-----|-----|-----|-----|-----|-----|-----|-----|-----|-----|-----|-----|-----|-----|-----|-----|-----|-----|-----|-----|-----|

site plan symbols

|     |     |     |     |     |     |     |     |     |     |     |     |     |     |     |     |     |     |     |     |     |     |     |     |     |     |     |     |     |     |     |     |     |     |     |     |     |     |     |     |     |     |     |     |     |     |     |     |     |     |     |     |     |     |     |     |     |     |     |     |     |     |     |     |     |     |     |     |     |     |     |     |     |     |     |     |     |     |     |     |     |     |     |     |     |     |     |     |     |     |     |     |     |     |     |     |     |     |     |     |
|-----|-----|-----|-----|-----|-----|-----|-----|-----|-----|-----|-----|-----|-----|-----|-----|-----|-----|-----|-----|-----|-----|-----|-----|-----|-----|-----|-----|-----|-----|-----|-----|-----|-----|-----|-----|-----|-----|-----|-----|-----|-----|-----|-----|-----|-----|-----|-----|-----|-----|-----|-----|-----|-----|-----|-----|-----|-----|-----|-----|-----|-----|-----|-----|-----|-----|-----|-----|-----|-----|-----|-----|-----|-----|-----|-----|-----|-----|-----|-----|-----|-----|-----|-----|-----|-----|-----|-----|-----|-----|-----|-----|-----|-----|-----|-----|-----|-----|-----|-----|
| 101 | 102 | 103 | 104 | 105 | 106 | 107 | 108 | 109 | 110 | 111 | 112 | 113 | 114 | 115 | 116 | 117 | 118 | 119 | 120 | 121 | 122 | 123 | 124 | 125 | 126 | 127 | 128 | 129 | 130 | 131 | 132 | 133 | 134 | 135 | 136 | 137 | 138 | 139 | 140 | 141 | 142 | 143 | 144 | 145 | 146 | 147 | 148 | 149 | 150 | 151 | 152 | 153 | 154 | 155 | 156 | 157 | 158 | 159 | 160 | 161 | 162 | 163 | 164 | 165 | 166 | 167 | 168 | 169 | 170 | 171 | 172 | 173 | 174 | 175 | 176 | 177 | 178 | 179 | 180 | 181 | 182 | 183 | 184 | 185 | 186 | 187 | 188 | 189 | 190 | 191 | 192 | 193 | 194 | 195 | 196 | 197 | 198 | 199 | 200 |
|-----|-----|-----|-----|-----|-----|-----|-----|-----|-----|-----|-----|-----|-----|-----|-----|-----|-----|-----|-----|-----|-----|-----|-----|-----|-----|-----|-----|-----|-----|-----|-----|-----|-----|-----|-----|-----|-----|-----|-----|-----|-----|-----|-----|-----|-----|-----|-----|-----|-----|-----|-----|-----|-----|-----|-----|-----|-----|-----|-----|-----|-----|-----|-----|-----|-----|-----|-----|-----|-----|-----|-----|-----|-----|-----|-----|-----|-----|-----|-----|-----|-----|-----|-----|-----|-----|-----|-----|-----|-----|-----|-----|-----|-----|-----|-----|-----|-----|-----|-----|

architectural symbols

|     |     |     |     |     |     |     |     |     |     |     |     |     |     |     |     |     |     |     |     |     |     |     |     |     |     |     |     |     |     |     |     |     |     |     |     |     |     |     |     |     |     |     |     |     |     |     |     |     |     |     |     |     |     |     |     |     |     |     |     |     |     |     |     |     |     |     |     |     |     |     |     |     |     |     |     |     |     |     |     |     |     |     |     |     |     |     |     |     |     |     |     |     |     |     |     |     |     |     |     |
|-----|-----|-----|-----|-----|-----|-----|-----|-----|-----|-----|-----|-----|-----|-----|-----|-----|-----|-----|-----|-----|-----|-----|-----|-----|-----|-----|-----|-----|-----|-----|-----|-----|-----|-----|-----|-----|-----|-----|-----|-----|-----|-----|-----|-----|-----|-----|-----|-----|-----|-----|-----|-----|-----|-----|-----|-----|-----|-----|-----|-----|-----|-----|-----|-----|-----|-----|-----|-----|-----|-----|-----|-----|-----|-----|-----|-----|-----|-----|-----|-----|-----|-----|-----|-----|-----|-----|-----|-----|-----|-----|-----|-----|-----|-----|-----|-----|-----|-----|-----|
| 101 | 102 | 103 | 104 | 105 | 106 | 107 | 108 | 109 | 110 | 111 | 112 | 113 | 114 | 115 | 116 | 117 | 118 | 119 | 120 | 121 | 122 | 123 | 124 | 125 | 126 | 127 | 128 | 129 | 130 | 131 | 132 | 133 | 134 | 135 | 136 | 137 | 138 | 139 | 140 | 141 | 142 | 143 | 144 | 145 | 146 | 147 | 148 | 149 | 150 | 151 | 152 | 153 | 154 | 155 | 156 | 157 | 158 | 159 | 160 | 161 | 162 | 163 | 164 | 165 | 166 | 167 | 168 | 169 | 170 | 171 | 172 | 173 | 174 | 175 | 176 | 177 | 178 | 179 | 180 | 181 | 182 | 183 | 184 | 185 | 186 | 187 | 188 | 189 | 190 | 191 | 192 | 193 | 194 | 195 | 196 | 197 | 198 | 199 | 200 |
|-----|-----|-----|-----|-----|-----|-----|-----|-----|-----|-----|-----|-----|-----|-----|-----|-----|-----|-----|-----|-----|-----|-----|-----|-----|-----|-----|-----|-----|-----|-----|-----|-----|-----|-----|-----|-----|-----|-----|-----|-----|-----|-----|-----|-----|-----|-----|-----|-----|-----|-----|-----|-----|-----|-----|-----|-----|-----|-----|-----|-----|-----|-----|-----|-----|-----|-----|-----|-----|-----|-----|-----|-----|-----|-----|-----|-----|-----|-----|-----|-----|-----|-----|-----|-----|-----|-----|-----|-----|-----|-----|-----|-----|-----|-----|-----|-----|-----|-----|-----|

material symbols

|     |     |     |     |     |     |     |     |     |     |     |     |     |     |     |     |     |     |     |     |     |     |     |     |     |     |     |     |     |     |     |     |     |     |     |     |     |     |     |     |     |     |     |     |     |     |     |     |     |     |     |     |     |     |     |     |     |     |     |     |     |     |     |     |     |     |     |     |     |     |     |     |     |     |     |     |     |     |     |     |     |     |     |     |     |     |     |     |     |     |     |     |     |     |     |     |     |     |     |     |
|-----|-----|-----|-----|-----|-----|-----|-----|-----|-----|-----|-----|-----|-----|-----|-----|-----|-----|-----|-----|-----|-----|-----|-----|-----|-----|-----|-----|-----|-----|-----|-----|-----|-----|-----|-----|-----|-----|-----|-----|-----|-----|-----|-----|-----|-----|-----|-----|-----|-----|-----|-----|-----|-----|-----|-----|-----|-----|-----|-----|-----|-----|-----|-----|-----|-----|-----|-----|-----|-----|-----|-----|-----|-----|-----|-----|-----|-----|-----|-----|-----|-----|-----|-----|-----|-----|-----|-----|-----|-----|-----|-----|-----|-----|-----|-----|-----|-----|-----|-----|
| 101 | 102 | 103 | 104 | 105 | 106 | 107 | 108 | 109 | 110 | 111 | 112 | 113 | 114 | 115 | 116 | 117 | 118 | 119 | 120 | 121 | 122 | 123 | 124 | 125 | 126 | 127 | 128 | 129 | 130 | 131 | 132 | 133 | 134 | 135 | 136 | 137 | 138 | 139 | 140 | 141 | 142 | 143 | 144 | 145 | 146 | 147 | 148 | 149 | 150 | 151 | 152 | 153 | 154 | 155 | 156 | 157 | 158 | 159 | 160 | 161 | 162 | 163 | 164 | 165 | 166 | 167 | 168 | 169 | 170 | 171 | 172 | 173 | 174 | 175 | 176 | 177 | 178 | 179 | 180 | 181 | 182 | 183 | 184 | 185 | 186 | 187 | 188 | 189 | 190 | 191 | 192 | 193 | 194 | 195 | 196 | 197 | 198 | 199 | 200 |
|-----|-----|-----|-----|-----|-----|-----|-----|-----|-----|-----|-----|-----|-----|-----|-----|-----|-----|-----|-----|-----|-----|-----|-----|-----|-----|-----|-----|-----|-----|-----|-----|-----|-----|-----|-----|-----|-----|-----|-----|-----|-----|-----|-----|-----|-----|-----|-----|-----|-----|-----|-----|-----|-----|-----|-----|-----|-----|-----|-----|-----|-----|-----|-----|-----|-----|-----|-----|-----|-----|-----|-----|-----|-----|-----|-----|-----|-----|-----|-----|-----|-----|-----|-----|-----|-----|-----|-----|-----|-----|-----|-----|-----|-----|-----|-----|-----|-----|-----|-----|

SEE FOREVER VILLAGE  
 SUNNY RIDGE PLACE  
 TELLURIDE, COLORADO  
 BUILDING "A" PHASE II

|     |     |     |     |     |     |     |     |     |     |     |     |     |     |     |     |     |     |     |     |     |     |     |     |     |     |     |     |     |     |     |     |     |     |     |     |     |     |     |     |     |     |     |     |     |     |     |     |     |     |     |     |     |     |     |     |     |     |     |     |     |     |     |     |     |     |     |     |     |     |     |     |     |     |     |     |     |     |     |     |     |     |     |     |     |     |     |     |     |     |     |     |     |     |     |     |     |     |     |     |
|-----|-----|-----|-----|-----|-----|-----|-----|-----|-----|-----|-----|-----|-----|-----|-----|-----|-----|-----|-----|-----|-----|-----|-----|-----|-----|-----|-----|-----|-----|-----|-----|-----|-----|-----|-----|-----|-----|-----|-----|-----|-----|-----|-----|-----|-----|-----|-----|-----|-----|-----|-----|-----|-----|-----|-----|-----|-----|-----|-----|-----|-----|-----|-----|-----|-----|-----|-----|-----|-----|-----|-----|-----|-----|-----|-----|-----|-----|-----|-----|-----|-----|-----|-----|-----|-----|-----|-----|-----|-----|-----|-----|-----|-----|-----|-----|-----|-----|-----|-----|
| 101 | 102 | 103 | 104 | 105 | 106 | 107 | 108 | 109 | 110 | 111 | 112 | 113 | 114 | 115 | 116 | 117 | 118 | 119 | 120 | 121 | 122 | 123 | 124 | 125 | 126 | 127 | 128 | 129 | 130 | 131 | 132 | 133 | 134 | 135 | 136 | 137 | 138 | 139 | 140 | 141 | 142 | 143 | 144 | 145 | 146 | 147 | 148 | 149 | 150 | 151 | 152 | 153 | 154 | 155 | 156 | 157 | 158 | 159 | 160 | 161 | 162 | 163 | 164 | 165 | 166 | 167 | 168 | 169 | 170 | 171 | 172 | 173 | 174 | 175 | 176 | 177 | 178 | 179 | 180 | 181 | 182 | 183 | 184 | 185 | 186 | 187 | 188 | 189 | 190 | 191 | 192 | 193 | 194 | 195 | 196 | 197 | 198 | 199 | 200 |
|-----|-----|-----|-----|-----|-----|-----|-----|-----|-----|-----|-----|-----|-----|-----|-----|-----|-----|-----|-----|-----|-----|-----|-----|-----|-----|-----|-----|-----|-----|-----|-----|-----|-----|-----|-----|-----|-----|-----|-----|-----|-----|-----|-----|-----|-----|-----|-----|-----|-----|-----|-----|-----|-----|-----|-----|-----|-----|-----|-----|-----|-----|-----|-----|-----|-----|-----|-----|-----|-----|-----|-----|-----|-----|-----|-----|-----|-----|-----|-----|-----|-----|-----|-----|-----|-----|-----|-----|-----|-----|-----|-----|-----|-----|-----|-----|-----|-----|-----|-----|



Date: 09/25  
 Project No: 245-005  
 Drawn by: CSM  
 Checked by: KAO

AA1.0  
 COVER SHEET  
 BLDG



# project data

## BUILDING CODE:

INTERNATIONAL BUILDING CODE 2000 EDITION  
 UNIFORM ELECTRICAL CODE, 2000 EDITION  
 UNIFORM MECHANICAL CODE, 2000 EDITION  
 UNIFORM PLUMBING CODE, 2000 EDITION  
 UNIFORM FIRE CODE, 1997 EDITION

## OCCUPANCY GROUP:

MIXED: R-2 (RESIDENTIAL)  
 S-2 (PARKING GARAGE)  
 R-2 (RESIDENTIAL)  
 A-2 (RESTAURANT)

## REQUIRED SEPARATIONS:

FROM R-2 TO S-2 = 2 HRS.  
 FROM S-2 TO R-2 = 2 HRS.  
 FROM S-2 TO A-2 = 2 HRS.  
 FROM R-2 TO R-2 = 1 HR.

## CONSTRUCTION TYPE:

TYPE II-B (FULLY SPRINKLERED)  
 ABOVE THE S-2 TO R-2 2 HR HORIZONTAL ASSEMBLY  
 TYPE I-A (FULLY SPRINKLERED)  
 BELOW THE 2 HR HORIZONTAL ASSEMBLIES

## ADDITIONAL REQUIREMENTS:

AN APPROVED AUTOMATIC SPRINKLER SYSTEM IS REQUIRED TO BE INSTALLED IN ACCORDANCE WITH SECTION 904 & SECTION 903.3.1.1 OF THE 2000 IBC.  
 STRUCTURAL BEAMS & COLUMNS ARE TO BE INDIVIDUALLY FIRE PROTECTED WITH AN AUTOMATIC SPRINKLER SYSTEM IN ACCORDANCE WITH SECTION 903.3.1.1 OF THE 2000 IBC

# area analysis



### GARDEN LEVEL

GROSS AREA 3,637 SF.

### LEVEL 1

LOBBY 3,248 SF.  
 GROSS AREA 15,252 SF.

### LEVEL 2

GROSS AREA 14,581 SF.

### LEVEL 3

GROSS AREA 14,553 SF.

### LEVEL 4

GROSS AREA 8,215 SF.

### TOTAL BUILDING SF. (EXCLUDING GARAGE LEVEL)

GROSS AREA 56,238 SF.

# Town of Mountain Village

## DEPARTMENT OF BUILDING INSPECTION

### TEMPORARY CERTIFICATE OF OCCUPANCY

This temporary certificate of occupancy is issued pursuant to the requirements of the 2012 International Building Code, and the 2017 NEC, certifying that at the time of the issuance this structure was inspected for compliance with various ordinances of the Town of Mountain Village, regulating building construction this temporary occupancy expires 4-15-18 at which time all minor code deficiencies must be fixed and a CO must be issued. Failure to meet minimal code standards will result in the revocation of the TCO and will cause the building to be posted. This TCO is for the following:

|                     |                    |                      |                      |
|---------------------|--------------------|----------------------|----------------------|
| Use Classification  | Condo              | Building Permit No.  | 2017-mvl-00056       |
| Group               | R-2                | Type of Construction | 2B                   |
| Owner of Building   | Mountain View LLC  | Occupancy Load       | N/A                  |
| Project Address     | 117 Sunny Ridge PL | Locality             | Mountain Village, CO |
| Fire Sprinkler Type | NFPA 13            |                      |                      |

Conditions: Addition roofing completion, Fire department sign off, Garage ceiling fire protection, other Mountain Village department required approvals.

By: \_\_\_\_\_

Randy Kee - Chief Building Official

Date: \_\_\_\_\_

**From:** Steve Thomas [<mailto:sthomas@coloradocode.net>]  
**Sent:** Monday, August 12, 2019 2:43 PM  
**To:** [dharrington@mtnvillage.org](mailto:dharrington@mtnvillage.org)  
**Cc:** 'David Eckman' <[davide@prosetconstruction.com](mailto:davide@prosetconstruction.com)>; Dan Reedy <[Dan@onshorejupiter.com](mailto:Dan@onshorejupiter.com)>  
**Subject:** See Forever, Unit GL 101 Request

Drew,

It was good to speak with you last week about the above project. I have attached the letter we discussed for your review. Please let me know if you need any additional information or have questions.

Thanks,

Steve Thomas  
President

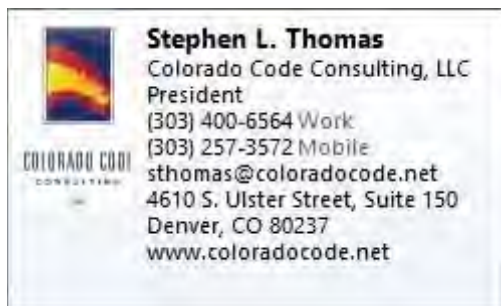

*The information contained in this e-mail message is confidential and may be legally privileged and is intended only for the use of the individual or entity named above. If you are not an intended recipient or if you have received this message in error, you are hereby notified that any dissemination, distribution or copy of this e-mail is strictly prohibited. If you have received this e-mail in error, please immediately notify us by return e-mail or telephone if the sender's phone number is listed above, then promptly and permanently delete this message. Thank you for your cooperation and consideration.*





# Colorado Code Consulting, LLC

## Main Office

4610 S Ulster, Ste. 150  
Denver, CO 80237  
(303) 400-6564  
Fax: (303) 693-0630

## Southern Office

17890 Woodhaven Dr.  
Colorado Springs, CO 80908  
303-895-9988

August 12, 2019

Mr. Drew Harrington  
Building Official  
Town of Mountain Village  
411 Mountain Village Blvd.  
Mountain Village, Colorado 81435

Re: See Forever Village, Unit GL101  
Occupancy Separation Review

Dear Mr. Harrington:

I am writing this letter on behalf of Mr. Dan Reedy, the owner of the above unit. It is my understanding that the project involved a change of occupancy from a Group A-2 restaurant to a Group R-2 Condominium. I also understand that the project is currently under a temporary certificate of occupancy because the occupancy separation between the dwelling unit and the parking garage below has not been completed as shown on the drawings. Mr. David Eckman contacted me for assistance and connected me with the owner. Mr. Reedy requested that I determine if there was any way that the separation would not be required. We had conversations regarding the issue and I believe that there is a case for not requiring the fire protection of the supporting structure for the occupancy separation. This letter is a request that you permit the change of occupancy without requiring the supporting structure to be protected. The references in this letter will be based on the 2012 International Building Code (IBC)

The building appears to be a Type IIB building based on the information I was provided. Therefore, the structural frame is not required to be provided with any fire protection per Table 601. The IBC requires that the R-2 residential occupancy be separated from the S-2 parking garage by a one-hour occupancy separation per Table 508.4. The existing concrete floor assembly will provide that level of protection per Table 721.1(3), Item 1-1.1. Therefore, the occupancy separation is provided at the floor and wall surfaces. However, Section 711.4 requires that the structure supporting the horizontal assembly to be protected at the same level as the floor assembly (one-hour). This protection should have been provided when the building was originally built but wasn't.

The existing steel in the garage is unprotected throughout the garage as originally approved. In order to go back and provide the required protection, it would require the removal of ducts, plumbing, electrical, walls and other systems. It would have a significant impact on the other owners of the building for the benefit of one condominium owner. The owner and contractor did

not realize how much this would cost when the drawings were originally submitted showing the protection of the beams and columns. They are therefore coming to you for this consideration.

We would like to propose that you consider the language in Section 3408.1. This is the section regarding a change of occupancy and requires that the building where the change of occupancy occurs comply with the current code. However, the second sentence states, "Subject to the approval of the building official, the use or occupancy of existing buildings shall be permitted to be changed and the building is allowed to be occupied for purposes in other groups without conforming to all the requirements of this code for those groups, provided the new or proposed use is less hazardous, based on life and fire risk, than the existing use". It is our position that the new Group R-2 occupancy is less hazardous than the previously approved Group A-2 occupancy and that the building official has the authority to make exceptions with supporting documentation.

If you compare the heights and areas of the two occupancies, the Group R-2 occupancy is less hazardous than the Group A-2 occupancy. The tabular height and area in Table 503 for a A-2/Type IIB building is 9,500 SF and 2 stories. The tabular height and area for the R-2/IIB building is 16,000 SF and 4 stories. Based on these two factors the Group R-2 is less hazardous because you can build a larger and taller building than for a Group A-2 occupancy. The occupant load factor is another way to look at the level of risk of life. The occupant load for the assembly space is 15 SF per occupant. However, the load for a residential use is 200 SF per occupant. Therefore, there is a higher risk to life with the larger occupant load in the assembly space versus the residential use.

Another way to evaluate whether one use is less hazardous is within the International Existing Building Code (IEBC). We are not proposing to use this code for this project. However, it has good information that can help with this evaluation. There are three tables in Section 1012 that rate the different occupancies on their relative hazards. The relative hazards are Highest Hazard – 1 and the Lowest Hazard – 5. Table 1012.4 regarding the means of egress rates the two occupancies as the same relative hazard (3). Table 1012.5 covers building height and area hazards. Once again, the table rates the two occupancies as the same relative hazard (2). The last Table 1012.6 addresses exterior openings. It also rates the two occupancies as having the same relative hazard (3). So, by using these tables you can see that the change of occupancy is not being made to a higher hazard.

In addition to using the tables to evaluate the fire and life safety risk in this change of occupancy. Section 1012.5.3 of the IEBC states, "When a change of occupancy classification is made to a higher hazard category as shown in Table 1012.5, fire barriers in separated mixed use buildings shall comply with the fire-resistance requirements of the International Building Code". Even though we are not using this code at this point, it is my opinion that the intent here is that if the change of occupancy is made to an equal or lesser relative hazard for height and area, the occupancy separation would not be required and therefore, the supporting structure would not need to be protected.

Based on the information provided, it is our position that the change of occupancy was to a new occupancy that is less hazardous, based on life and fire risk, than the existing use. Therefore, we would like to request that the supporting beams and columns not be required to be provided with fire-resistant rated protection. The original building was approved and has been allowed without this protection. We believe that we have shown that the second sentence in Section 3408.1 has been met and the building official can choose not to require the protection.

Thank you for the opportunity to evaluate the above issue. All opinions in this report are based on the information provided to our office. We do not accept any responsibility for any condition that

was not known at the time of this report. Colorado Code Consulting, LLC reserves the right to amend this report if additional information is received. It is the responsibility of the registered design professional to ensure compliance with the applicable codes. This letter is advisory only and should not be construed to be approval of any code requirements. Thank you for the opportunity to be of assistance and provide our comments regarding this project. If you need additional information or have any questions, please do not hesitate to call.

Sincerely,

A handwritten signature in black ink, appearing to read 'S. L. Thomas', with a stylized flourish at the end.

Stephen L. Thomas, CBO, CBCO, CHCO  
President

**From:** Dan Reedy <[Dan@onshorejupiter.com](mailto:Dan@onshorejupiter.com)>  
**Sent:** Wednesday, September 18, 2019 10:36 AM  
**To:** 'Steve Thomas' <[sthomas@coloradocode.net](mailto:sthomas@coloradocode.net)>; Drew Harrington <[DHarrington@mtnvillage.org](mailto:DHarrington@mtnvillage.org)>  
**Cc:** 'David Eckman' <[davide@prosetconstruction.com](mailto:davide@prosetconstruction.com)>  
**Subject:** RE: See Forever, Unit GL 101 Request

Drew,

Thanks for meeting with Scott Lawshe and me today at Seeforever Village.

As discussed can you please forward to me the applicable code that requires the area under the footprint of GL 101 to have the 1 hour fire barrier around the structural support members?

Thanks again.

Dan

**Dan Reedy**  
**Onshore Construction & Development, Inc.**  
**938 North Old Dixie Hwy.**  
**Jupiter, Florida 33458**  
**561-744-8331 office**  
**561-262-3189 cell**  
**561-743-0705 Fax**

**Visit our web site at: [www.onshorejupiter.com](http://www.onshorejupiter.com)**

*The information provided herein is for information purposes only. Nothing contained herein is intended to obligate or bind OnShore unless signed by all parties in a contract.*



**From:** Drew Harrington [<mailto:DHarrington@mtnvillage.org>]  
**Sent:** Wednesday, September 18, 2019 1:21 PM  
**To:** Dan Reedy <[Dan@onshorejupiter.com](mailto:Dan@onshorejupiter.com)>  
**Subject:** RE: See Forever, Unit GL 101 Request

Here you go Dan

Drew Harrington  
Building Official  
Planning & Building Department  
**Town of Mountain Village**  
455 Mountain Village Blvd, Suite A  
Mountain Village, CO 81435  
O :: 970.369.8251  
C:: 970.708.7537  
F :: 970.728.4342

Website for CommunityCore for Contractors: <https://app.communitycore.com/app/account/login>

**From:** Dan Reedy <[Dan@onshorejupiter.com](mailto:Dan@onshorejupiter.com)>  
**Sent:** Wednesday, September 18, 2019 10:36 AM  
**To:** 'Steve Thomas' <[stthomas@coloradocode.net](mailto:stthomas@coloradocode.net)>; Drew Harrington <[DHarrington@mtnvillage.org](mailto:DHarrington@mtnvillage.org)>  
**Cc:** 'David Eckman' <[davide@prosetconstruction.com](mailto:davide@prosetconstruction.com)>  
**Subject:** RE: See Forever, Unit GL 101 Request

Drew,

Thanks for meeting with Scott Lawshe and me today at Seeforever Village.

As discussed can you please forward to me the applicable code that requires the area under the footprint of GL 101 to have the 1 hour fire barrier around the structural support members?

Thanks again.

Dan

**Dan Reedy**  
**Onshore Construction & Development, Inc.**  
**938 North Old Dixie Hwy.**  
**Jupiter, Florida 33458**  
**561-744-8331 office**  
**561-262-3189 cell**  
**561-743-0705 Fax**

Visit our web site at: [www.onshorejupiter.com](http://www.onshorejupiter.com)

*The information provided herein is for information purposes only. Nothing contained herein is intended to obligate or bind OnShore unless signed by all parties in a contract.*





er, the enclosure walls extending above such floor used as the horizontal assembly having a minimum 3-hour fire-resistance rating shall be permitted to have a 1-hour fire-resistance rating provided:

1. The building above is not required to be of Type I construction; and
2. The enclosure walls do not enclose an exit stairway, a ramp or an escalator required to have enclosure walls with not less than a 2-hour fire-resistance rating.
2. The building above the horizontal assembly having a minimum 3-hour fire-resistance rating contains only Group A having an assembly room with an occupant load of less than 300, or Group B or M; and
3. The building below the horizontal assembly having a minimum 3-hour fire-resistance rating is a Group S-2 enclosed parking garage, used exclusively for the parking and storage of private motor vehicles.

#### Exceptions:

1. Entry lobbies, mechanical rooms and similar uses incidental to the operation of the building shall be permitted.
2. Group A having an assembly room with an occupant load of less than 300, or Group B; or M; and shall be permitted in addition to those uses incidental to the operation of the building (including storage areas), provided that the entire structure below the horizontal assembly having a minimum 3-hour fire-resistance rating is protected throughout by an approved automatic sprinkler system.
4. The maximum building height in feet shall not exceed the limits set forth in Table 503 for the least restrictive type of construction involved.

**508.3 Group S-2 enclosed parking garage with Group S-2 open parking garage above.** A Group S-2 enclosed parking garage located in the basement or first story below a Group S-2 open parking garage shall be classified as a separate and distinct building for the purpose of determining the type of construction when the following conditions are met:

1. The allowable area of the structure shall be such that the sum of the ratios of the actual area divided by the allowable area for each separate occupancy shall not exceed 1.0.
2. The Group S-2 enclosed parking garage is of Type I or II construction and is at least equal to the fire-resis-

tance requirements of the Group S-2 Open Parking Garage.

3. The height and the number of the floors above the basement shall be limited as specified in Table 406.3.5.
4. The floor assembly separating the Group S-2 enclosed parking garage and Group S-2 open parking garage shall be protected as required for the floor assembly of the Group S-2 enclosed parking garage. Openings between the Group S-2 enclosed parking garage and Group S-2 open parking garage, except exit openings, shall not be required to be protected.
5. The Group S-2 enclosed parking garage is used exclusively for the parking or storage of private motor vehicles, but shall be permitted to contain an office, waiting room and toilet room having a total area of not more than 1,000 square feet (93 m<sup>2</sup>), and mechanical equipment rooms incidental to the operation of the building.

#### 508.4 Special unlimited height for Groups B, M and R.

The height of Group B, M and R buildings of Type IB construction shall not be limited, provided the fire resistance of columns shall be not less than 3 hours and the other structural members, including floors, shall be not less than that shown in Chapter 6, but in no case less than 2 hours, except that roofs and their supporting beams, girders, trusses and arches shall be not less than 1 1/2 hours.

**508.5 Parking beneath Group R.** Where a maximum one-story above grade plane Group S-2 parking garage, enclosed or open, or combination thereof, of Type I construction or open of Type IV construction, with grade entrance, is provided under a building of Group R, the number of stories to be used in determining the minimum type of construction may be measured from the floor above such a parking area. **The floor assembly between the parking garage and the Group R above shall comply with the type of construction required for the parking garage and shall also provide a fire-resistance rating not less than the mixed occupancy separation required in Section 302.3.3.**

**508.6 Group R-2 buildings of Type IIIA construction.** The height limitation for buildings of Type IIIA construction in Group R-2 shall be increased to six stories and 75 feet (22 860 mm) where the first floor construction above the basement has a fire-resistance rating of not less than 3 hours and the floor area is subdivided by 2-hour fire-resistance-rated fire walls into areas of not more than 3,000 square feet (279 m<sup>2</sup>).

**508.7 Group R-2 buildings of Type IIA construction.** The height limitation for buildings of Type IIA construction in Group R-2 shall be increased to nine stories and 100 feet (30 480 mm) where the building is separated by not less than 50 feet (15 240 mm) from any other building on the lot and from property lines, the exits are segregated in an area enclosed by

FIRE  
RESIST  
CONSTFIRE  
WALLSPENETRA-  
TIONSOPENING  
PROT.INTERIOR  
FINISHESFIRE  
PROT. SYSMOKE  
CONTRMEANS  
EGRESSMAX  
FLOOR  
AREAEXIT  
ACCE

EXIT

EXIT  
DISCHACCE  
IBILITINTER  
ENVIRTYPES OF  
CONST



**Installation.** Fire-resistant joint systems shall be installed in or on the joint for its entire length so as to dislodge, loosen or otherwise impair its ability to resist the expected building movements and to resist the effects of fire and hot gases.

**Fire test criteria.** Fire-resistant joint systems shall be tested in accordance with the requirements of UL 2079. Asymmetrical wall joint systems shall be tested with both sides exposed to the furnace, and the assigned fire-resistance rating shall be the shortest duration obtained from the two tests. When evidence is furnished to show that the wall was tested with the least fire-resistant side exposed to the furnace, the test to acceptance of the building official, the wall need not be subjected to tests from the opposite side.

**Exception:** For exterior walls with a horizontal fire separation distance greater than 5 feet (1524 mm), the joint system shall be required to be tested for interior fire exposure only.

**4 Exterior curtain wall/floor intersection.** Where fire-resistance-rated floor or floor/ceiling assemblies are provided, voids created at the intersection of the exterior curtain wall assemblies and such floor assemblies shall be sealed with an approved material. Such material shall be securely fastened and capable of preventing the passage of flame and gases sufficient to ignite cotton waste when subjected to a minimum positive pressure differential of 0.01 inch (0.254 mm) water column (2.5 Pa) for the time period at least equal to the fire-resistance rating of the floor assembly.

**SECTION 713  
FIRE-RESISTANCE RATING OF  
STRUCTURAL MEMBERS**

**713.1 Requirements.** The fire-resistance rating of structural members and assemblies shall comply with the requirements for the type of construction and shall not be less than the rating required for the fire-resistance-rated assemblies supported.

**Exception:** Fire barriers and fire partitions as provided in Sections 706.4 and 708.4, respectively.

**713.2 Protection of structural members.** Protection of columns, girders, trusses, beams, lintels or other structural members that are required to have a fire-resistance rating shall comply with this section.

**713.2.1 Individual protection.** Columns, girders, trusses, beams, lintels or other structural members that are required to have a fire-resistance rating and that support more than two floors or one floor and roof, or support a load-bearing wall or a nonload-bearing wall more than two stories high, shall be individually protected on all sides for the full length with materials having the required fire-resistance rating. Other structural members required to have a fire-resistance rating shall be protected by indi-

vidual encasement, by a membrane or ceiling protection as specified in Section 710, or by a combination of both. Columns shall also comply with Section 713.2.2.

**713.2.2 Column protection above ceilings.** Where columns require a fire-resistance rating, the entire column, including its connections to beams or girders, shall be protected. Where the column extends through a ceiling, fire resistance of the column shall be continuous from the top of the floor through the ceiling space to the top of the column.

**713.2.3 Truss protection.** The required thickness and construction of fire-resistance-rated assemblies enclosing trusses shall be based on the results of full-scale tests or combinations of tests on truss components or on approved calculations based on such tests that satisfactorily demonstrate that the assembly has the required fire resistance.

**713.2.4 Attachments to structural members.** The edges of lugs, brackets, rivets and bolt heads attached to structural members shall be permitted to extend to within 1 inch (25 mm) of the surface of the fire protection.

**713.2.5 Reinforcing.** Thickness of protection for concrete or masonry reinforcement shall be measured to the outside of the reinforcement except that stirrups and spiral reinforcement ties are permitted to project not more than 0.5-inch (12.7 mm) into the protection.

**713.3 Embedments and enclosures.** Pipes, wires, conduits, ducts or other service facilities shall not be embedded in the required fire protective covering of a structural member that is required to be individually encased.

**713.4 Impact protection.** Where the fire protective covering of a structural member is subject to impact damage from moving vehicles, the handling of merchandise or other activity, the fire protective covering shall be protected by corner guards or by a substantial jacket of metal or other noncombustible material to a height adequate to provide full protection, but not less than 5 feet (1524 mm) from the finished floor.

**713.5 Exterior structural members.** Structural members located in exterior walls or along the outer lines of a building or structure shall be protected as required by Table 601 for exterior load-bearing walls based on the type of construction. Structural frame elements in an exterior wall that is located where openings are not permitted or where protection of openings is required shall be protected against external fire exposure as required for exterior bearing walls or the structural frame, whichever is greater.

**713.6 Bottom flange protection.** Fire protection is not required at the bottom flange of lintels, shelf angles and plates, spanning not more than 6 feet (1829 mm) whether part of the structural frame or not, and from the bottom flange of lintels, shelf angles and plates not part of the structural frame, regardless of span.

**714.1 General.** of this code sha

**714.2 Fire door and fire shutter.** material or assembly test requirements the fire-protect assemblies and the provisions

**Exceptions:**

- 1. Labeling requirements UL 14
- 2. Floor

**OPENING F**

| TYPE OF ASSEMBLY                                                                                    |
|-----------------------------------------------------------------------------------------------------|
| Fire walls and having a required fire-resistance rating greater than 1 hour                         |
| Fire barriers of fire-resistance-rated construction:<br>Shaft and exit walls<br>Other fire barriers |
| Fire partitions:<br>Exit access corridors<br>Enclosure walls<br>Other fire partitions               |
| Exterior walls                                                                                      |

- a. For testing requirements
- b. Two doors, each on opposite sides of the opening, shall be provided in fire-protective enclosures

**714.2.1 Side-hinged and fire-protected doors.** In accordance with the NFPA 101, the fire-protective assembly shall be tested in accordance with the provisions of NFPA 101, less above the



TABLE 302.3.3  
REQUIRED SEPARATION OF OCCUPANCIES (HOURS)<sup>a</sup>

| USE                | A-1 | A-2 | A-3 | A-4 | A-5 | B <sup>b</sup> | E <sup>o</sup> | F-1 | F-2 | H-1 | H-2 | H-3 | H-4 | H-5 | I-1 | I-2 | I-3 | I-4 | M <sup>b</sup> | R-1 | R-2 | R-3,R-4 | S-1 | S-2 <sup>c</sup> | U              |
|--------------------|-----|-----|-----|-----|-----|----------------|----------------|-----|-----|-----|-----|-----|-----|-----|-----|-----|-----|-----|----------------|-----|-----|---------|-----|------------------|----------------|
| A-1                | 2   | 2   | 2   | 2   | 2   | 2              | 2              | 3   | 2   | NP  | 4   | 3   | 2   | 4   | 2   | 2   | 2   | 2   | 2              | 2   | 2   | 2       | 3   | 2                | 1              |
| A-2 <sup>h</sup>   | —   | 2   | 2   | 2   | 2   | 2              | 2              | 3   | 2   | NP  | 4   | 3   | 2   | 4   | 2   | 2   | 2   | 2   | 2              | 2   | 2   | 2       | 3   | 2                | 1              |
| A-3 <sup>d,f</sup> | —   | —   | 2   | 2   | 2   | 2              | 2              | 3   | 2   | NP  | 4   | 3   | 2   | 4   | 2   | 2   | 2   | 2   | 2              | 2   | 2   | 2       | 3   | 2                | 1              |
| A-4                | —   | —   | —   | 2   | 2   | 2              | 2              | 3   | 2   | NP  | 4   | 3   | 2   | 4   | 2   | 2   | 2   | 2   | 2              | 2   | 2   | 2       | 3   | 2                | 1              |
| A-5                | —   | —   | —   | —   | 2   | 2              | 2              | 3   | 2   | NP  | 4   | 3   | 2   | 4   | 2   | 2   | 2   | 2   | 2              | 2   | 2   | 2       | 3   | 2                | 1              |
| B <sup>b</sup>     | —   | —   | —   | —   | —   | 2              | 2              | 3   | 2   | NP  | 2   | 1   | 1   | 1   | 2   | 2   | 2   | 2   | 2              | 2   | 2   | 2       | 3   | 2                | 1              |
| E                  | —   | —   | —   | —   | —   | —              | 2              | 3   | 2   | NP  | 4   | 3   | 2   | 3   | 2   | 2   | 2   | 2   | 2              | 2   | 2   | 2       | 3   | 2                | 1              |
| F-1                | —   | —   | —   | —   | —   | —              | —              | 3   | 3   | NP  | 2   | 1   | 1   | 1   | 3   | 3   | 3   | 3   | 3              | 3   | 3   | 3       | 3   | 3                | 3              |
| F-2                | —   | —   | —   | —   | —   | —              | —              | —   | 2   | NP  | 2   | 1   | 1   | 1   | 2   | 2   | 2   | 2   | 2              | 2   | 2   | 2       | 3   | 2                | 1              |
| H-1                | —   | —   | —   | —   | —   | —              | —              | —   | —   | 4   | NP  | NP  | NP  | NP  | NP  | NP  | NP  | NP  | NP             | NP  | NP  | NP      | NP  | NP               | NP             |
| H-2                | —   | —   | —   | —   | —   | —              | —              | —   | —   | —   | 4   | 1   | 2   | 2   | 4   | 4   | 4   | 4   | 2              | 4   | 4   | 4       | 2   | 2                | 1              |
| H-3                | —   | —   | —   | —   | —   | —              | —              | —   | —   | —   | —   | 3   | 1   | 1   | 4   | 3   | 3   | 3   | 1              | 3   | 3   | 3       | 1   | 1                | 1              |
| H-4                | —   | —   | —   | —   | —   | —              | —              | —   | —   | —   | —   | —   | 2   | 1   | 4   | 4   | 4   | 4   | 1              | 4   | 4   | 4       | 1   | 1                | 1              |
| H-5                | —   | —   | —   | —   | —   | —              | —              | —   | —   | —   | —   | —   | —   | 2   | 4   | 4   | 4   | 3   | 1              | 4   | 4   | 4       | 1   | 1                | 3              |
| I-1                | —   | —   | —   | —   | —   | —              | —              | —   | —   | —   | —   | —   | —   | —   | 2   | 2   | 2   | 2   | 2              | 2   | 2   | 2       | 4   | 3                | 2              |
| I-2                | —   | —   | —   | —   | —   | —              | —              | —   | —   | —   | —   | —   | —   | —   | —   | 2   | 2   | 2   | 2              | 2   | 2   | 2       | 3   | 2                | 1              |
| I-3                | —   | —   | —   | —   | —   | —              | —              | —   | —   | —   | —   | —   | —   | —   | —   | —   | 2   | 2   | 2              | 2   | 2   | 2       | 3   | 2                | 1              |
| I-4                | —   | —   | —   | —   | —   | —              | —              | —   | —   | —   | —   | —   | —   | —   | —   | —   | —   | 2   | 2              | 2   | 2   | 2       | 3   | 2                | 1              |
| M <sup>b</sup>     | —   | —   | —   | —   | —   | —              | —              | —   | —   | —   | —   | —   | —   | —   | —   | —   | —   | —   | 2              | 2   | 2   | 2       | 3   | 2                | 1              |
| R-1                | —   | —   | —   | —   | —   | —              | —              | —   | —   | —   | —   | —   | —   | —   | —   | —   | —   | —   | —              | 2   | 2   | 2       | 3   | 2                | 1              |
| R-2                | —   | —   | —   | —   | —   | —              | —              | —   | —   | —   | —   | —   | —   | —   | —   | —   | —   | —   | —              | —   | 2   | 2       | 3   | 2                | 1              |
| R-3, R-4           | —   | —   | —   | —   | —   | —              | —              | —   | —   | —   | —   | —   | —   | —   | —   | —   | —   | —   | —              | —   | —   | 2       | 3   | 2 <sup>g</sup>   | 1 <sup>g</sup> |
| S-1                | —   | —   | —   | —   | —   | —              | —              | —   | —   | —   | —   | —   | —   | —   | —   | —   | —   | —   | —              | —   | —   | —       | 3   | 3                | 3              |
| S-2 <sup>c</sup>   | —   | —   | —   | —   | —   | —              | —              | —   | —   | —   | —   | —   | —   | —   | —   | —   | —   | —   | —              | —   | —   | —       | —   | 2                | 1              |
| U                  | —   | —   | —   | —   | —   | —              | —              | —   | —   | —   | —   | —   | —   | —   | —   | —   | —   | —   | —              | —   | —   | —       | —   | —                | 1              |

For SI: 1 square foot = 0.0929 m<sup>2</sup>.

NP = Not permitted.

a. See Exception 1 to Section 302.3.3 for reductions permitted.

b. Occupancy separation need not be provided for incidental storage areas within Groups B and M if the:

1. Area is less than 10 percent of the floor area;
2. Area is provided with an automatic fire-extinguishing system and is less than 3,000 square feet; or
3. Area is less than 1,000 square feet.

c. Areas used only for private or pleasure vehicles may reduce separation by 1 hour.

d. Accessory assembly areas are not considered separate occupancies if the floor area is 750 square feet or less.

e. Assembly uses accessory to Group E are not considered separate occupancies.

f. Accessory religious educational rooms and religious auditoriums with occupant loads of less than 100 are not considered separate occupancies.

g. See exception to Section 302.3.3.

h. Commercial kitchens need not be separated from the restaurant seating areas that they serve.

FIRE RESIST CONST  
 FIRE WALLS  
 PENETRATIONS  
 OPENING PROT.  
 INTERI FINISHE  
 FIRE PROT. S  
 SMOKE CONTR  
 MEANS EGRES  
 MAX. FLOOR AREA  
 EXIT ACC  
 EXIT  
 EXIT INSC  
 ACC (HIL)  
 INTERI ENVI  
 EXIT  
 MIXED OCC TABLE  
 SPECIAL USE & OCC  
 HEIGHTS & AREAS  
 ALLOW HTS/AREAS  
 TYPES OF CONST



**From:** Dan Reedy <Dan@onshorejupiter.com>  
**Sent:** Monday, September 30, 2019 10:53 AM  
**To:** 'Drew Harrington' <DHarrington@mtnvillage.org>  
**Cc:** 'Joe Solomon' <jsolomon@montrose.net>; F. John Abrams <fjohnabrams@gmail.com>  
**Subject:** RE: See Forever, Unit GL 101 Request

Drew,

Thanks for sending.

I did not receive this letter via US Postal Service for some reason which is why I came to see you while in Mountain Village 2 weeks ago and also why I asked to meet you onsite. I am not sure why we did not receive as the address is accurate.

We will get back to you on this shortly

Thank you,

Dan

**Dan Reedy**  
**Onshore Construction & Development, Inc.**  
**938 North Old Dixie Hwy.**  
**Jupiter, Florida 33458**  
**561-744-8331 office**  
**561-262-3189 cell**  
**561-743-0705 Fax**

**Visit our web site at: [www.onshorejupiter.com](http://www.onshorejupiter.com)**

*The information provided herein is for information purposes only. Nothing contained herein is intended to obligate or bind OnShore unless signed by all parties in a contract.*



**From:** Drew Harrington [<mailto:DHarrington@mtnvillage.org>]  
**Sent:** Monday, September 30, 2019 9:37 AM  
**To:** Dan Reedy <[Dan@onshorejupiter.com](mailto:Dan@onshorejupiter.com)>  
**Cc:** 'Joe Solomon' <[jsolomon@montrose.net](mailto:jsolomon@montrose.net)>; F. John Abrams <[fjohnabrams@gmail.com](mailto:fjohnabrams@gmail.com)>  
**Subject:** RE: See Forever, Unit GL 101 Request

Dan here is a copy of the letter sent to you on August 20<sup>th</sup>.

Drew Harrington  
Building Official  
Planning & Building Department  
**Town of Mountain Village**  
455 Mountain Village Blvd, Suite A  
Mountain Village, CO 81435  
O :: 970.369.8251  
C:: 970.708.7537  
F :: 970.728.4342

Website for CommunityCore for Contractors: <https://app.communitycore.com/app/account/login>

**From:** Dan Reedy <[Dan@onshorejupiter.com](mailto:Dan@onshorejupiter.com)>  
**Sent:** Monday, September 30, 2019 4:58 AM  
**To:** Drew Harrington <[DHarrington@mtnvillage.org](mailto:DHarrington@mtnvillage.org)>  
**Cc:** 'Joe Solomon' <[jsolomon@montrose.net](mailto:jsolomon@montrose.net)>; F. John Abrams <[fjohnabrams@gmail.com](mailto:fjohnabrams@gmail.com)>  
**Subject:** RE: See Forever, Unit GL 101 Request

Drew,

Could you please send to me a written decision regarding the fireproofing of the structural steel support beams under the footprint of unit GL 101 at Seeforever Village?

Thank you,

Dan

**Dan Reedy**  
**Onshore Construction & Development, Inc.**  
**938 North Old Dixie Hwy.**  
**Jupiter, Florida 33458**  
**561-744-8331 office**  
**561-262-3189 cell**  
**561-743-0705 Fax**

**Visit our web site at: [www.onshorejupiter.com](http://www.onshorejupiter.com)**

*The information provided herein is for information purposes only. Nothing contained herein is intended to obligate or bind OnShore unless signed by all parties in a contract.*



August 20, 2019

SFV Mountain View LLC A Co LLC  
938 North Old Dixie Highway  
Jupiter, Fl, 33458

Re: See Forever Village, Unit GL101

Dear, Mr. Reedy

Greetings. I have reviewed the document sent to me from Colorado Code Consultants addressing possible alternatives to address the fire-resistant requirement of the structural beams and columns below your unit in the parking structure, a condition of your permit issuance.

Stephen L Thomas the president of Colorado Code Consultants has presented an option not requiring the structural beams to be covered under the existing building code. This option gives me as the Building Official the authority to wave the requirement if I choose too. The approved construction plans for your remodel required the fire assemblies to be maintained, the un-protected structural beams and columns below your unit were addressed during the construction phase of your unit by our previous Building Official Randy Kee.

The TCO issued 12-27-2017 by Randy Kee required the garage ceiling structural beams and columns below your unit in the parking garage to be protected, this was a requirement for the issued TCO and will be required prior to issuing the CO for your unit. Although Stephen Thomas pointed to a code provision that could allow the Building Official to waive this requirement, the town will not be waiving the requirement for the reasons stated in this letter. Primarily that the provision was stamped on your issued plan set and a condition of issuance of the TCO. It was not a new or added condition of building permit approval and would have been considered by your general contractor as part of their bid to perform the work required to change the commercial space to residential occupancy.

Your TCO has been expired as of 4-15-2018 and you are occupying the unit without a CO being issued. The other un-protected structural beams and columns in the parking structure is a separate issue and will be addressed as such. This is a life safety issue that affects the entire structure. In conclusion I will not waive this requirement. The town expects the necessary work to be performed within 60 days of receipt of this correspondence. If the work is not complete and the Town is unable to issue a Certificate of Occupancy, we will refer this issue to the legal department.

Sincerely Drew Harrington

Building Official  
Town Of mountain Village

On Jun 4, 2021, at 3:19 PM, Lawshe, Scott <[slawshe@thepeaksresort.com](mailto:slawshe@thepeaksresort.com)> wrote:

To Whom It May Concern,

I am writing this letter to give my personal opinion on the unit GL-101, Reedy residence, fire proofing issue. I would like to touch on a few points so everyone can make a well informed decision on this matter.

Unit GL-101 was designed as a commercial space that required a 2hr separation time from the parking garage to the commercial space as seen on the pictured required separations below. This Unit required a separate Certificate of Occupancy (CO) consistent with the permitting process for all Seeforever Units by the Town Of Mountain Village. For reference that would be S-2 to A-2 separation times. This complied with the 2000 edition of the international building code. In addition to meeting this separation time requirement, an additional requirement imposed by the town was that the garage have an automatic high pressure commercial sprinkler system installed. This garage high pressure sprinkler system well exceeded the Town and County fire requirements when the garage was given its CO. This addition to the fire suppression system can also be seen below. Therefore at the time of the 2000 international building code the garage and all Seeforever Units including Unit GL-101 met and exceeded the requirements for fire separation.

In addition to meeting all 2000 IBC codes Unit GL-101, which was converted to a residential space, continues to meet all 2018 IBC codes for fire separation for residential and commercial spaces. I have talked with our Fire Suppression Contractor, Dynamic Fire Suppression, and their president Gordan Mull. He states that with the two hour separation time and the high pressure garage sprinkler system, in addition to the unit being sprinklered as well, Unit GL- 101 should be compliant with all NFPA 13 requirements.

It's also important to note that the Seeforever garage was granted a CO as a separate completed building by the Town Of Mountain Village. The Residential and Commercial Units above and below the garage were required to be granted separate COs. Accordingly, Unit GL-101 should not be impacted by any new garage fire proofing requirements since the Town of Mountain Village did not require this as a condition of obtaining a CO on other Units at See Forever Village.

My next point of is that of potential equipment damage to HVAC systems and other General Common Elements in the area. We have multiple HVAC systems, water lines, gas lines, sewer lines, and shut off valves located directly in the suggested Fire proofing area with a fire retardant that could cause crucial equipment to be covered up and no longer accessible. Spraying the fire proofing material could also cause this equipment to be damaged leading to problems in multiple units and the entire buildings. This could be a significant financial and occupancy impact on all See Forever Village Owners if a repair is needed to be made in this area.

My last concern is intrusion to owners closets in the garage which are Limited Common Elements that belong to individual owners that fall in this space. These closets are full of valuable belongings. The idea of spraying these areas and intruding on these owners personal space is a potential liability to all parties involved.

In conclusion, in my opinion and opinion of other fire suppression professionals, unit GI-101 meets all building code requirements and NFPA requirements in the state of Colorado at the time that Temporary Certificate of Occupancy was issued years ago.

Thank you for taking the time to read our findings and hear our concerns. If you have additional questions please feel free to contact me.

Thanks,  
Scott Lawshe

Chief Engineer  
See Forever Village  
p: 601-613-8182  
e: [slawshe@tellurideskiresort.com](mailto:slawshe@tellurideskiresort.com)

**From:** [Bill Nictakis](#)  
**To:** [Michelle Haynes](#)  
**Cc:** [Bill Nictakis](#); [Bill Nictakis](#)  
**Subject:** See Forever hearing GL 101  
**Date:** Tuesday, September 7, 2021 7:02:14 PM

---

I am sending this email in regards to the matter regarding See Forever GL 101 that will be reviewed at the next town meeting.

I have owned in See Forever for about 4 years and am spending an increasing amount of time here...over half the year now. My wife Jean and I love Mountain Village and the unique ambiance of See Forever. Since we live here and do not rent, we are very much interested and concerned about maintaining the physical beauty and security of our property.

Having the residence in question transitioned from a potential restaurant to a residence was a huge win for See Forever owners. Thank you Mr Reedy for undertaking the tremendous investment in time and money to do that. After reading some of the background documents, I do not understand why the Town of Mountain Village would insist that the garage area beneath his unit have different fire proofing requirements than the rest of ours. First, there is less fire risk now that there is a residence versus a restaurant. Second, there will be significant inconvenience to owners while this work is being done, and once things are started, I will assume there is ancillary risk to electrical and mechanical systems in other units due to the construction process.

Therefore, as an owner, I support Mr Reedy and do not believe the additional fire proofing is needed

Sincerely

Bill Nictakis

See Forever Unit 119

Sent from my iPad



# Town of Mountain Village

## DEPARTMENT OF BUILDING INSPECTION

### TEMPORARY CERTIFICATE OF OCCUPANCY

This temporary certificate of occupancy is issued pursuant to the requirements of the 2012 International Building Code, and the 2017 NEC, certifying that at the time of the issuance this structure was inspected for compliance with various ordinances of the Town of Mountain Village, regulating building construction this temporary occupancy expires 4-15-18 at which time all minor code deficiencies must be fixed and a CO must be issued. Failure to meet minimal code standards will result in the revocation of the TCO and will cause the building to be posted. This TCO is for the following:

|                            |                           |                             |                             |
|----------------------------|---------------------------|-----------------------------|-----------------------------|
| <b>Use Classification</b>  | <b>Condo</b>              | <b>Building Permit No.</b>  | <b>2017-mvl-00056</b>       |
| <b>Group</b>               | <b>R-2</b>                | <b>Type of Construction</b> | <b>2B</b>                   |
| <b>Owner of Building</b>   | <b>Mountain View LLC</b>  | <b>Occupancy Load</b>       | <b>N/A</b>                  |
| <b>Project Address</b>     | <b>117 Sunny Ridge PL</b> | <b>Locality</b>             | <b>Mountain Village, CO</b> |
| <b>Fire Sprinkler Type</b> | <b>NFPA 13</b>            |                             |                             |

**Conditions: Addition roofing completion, Fire department sign off, Garage ceiling fire protection, other Mountain Village department required approvals.**

By: \_\_\_\_\_

Randy Kee - Chief Building Official

Date: \_\_\_\_\_

## BUILDING BOARD OF APPEALS HEARING AGREEMENT

This Building Board of Appeals Hearing Agreement is made and entered into on this 22<sup>nd</sup> day of April, 2020, by SFV Mountain View, LLC, a Colorado limited liability company (“**Owner**”) and the Town of Mountain Village, a home-rule municipality and political subdivision of the state of Colorado (the “**Town**”).

### RECITALS:

- A. Owner owns Unit GL-101, See Forever Village at the Peaks, Town of Mountain Village, Colorado (“**Property**”).
- B. Owner undertook a construction project in order to convert the Property from a shell commercial space to a residential unit and received a building permit number 2017MVL-00056 (the “**Permit**”) for such work.
- C. The Owner completed most of the work required under the permit, but on final inspection in order to issue a certificate of occupancy, the Town’s former building official did not find that certain work required by building codes and plan sets for the Property and Permit were completed. The uncompleted work was related to fireproofing the garage structural beams and columns (the “**Uncompleted Work**”). Therefore, the Town issued a temporary certificate of occupancy on December 27, 2017 (the “**TCO**”) requiring that the Uncompleted Work be completed before a full certificate of occupancy could be issued for the Property. The TCO expired on April 15, 2018.
- D. The Owner has not completed the work, but rather hired Colorado Code Consultants to write a letter stating that there was a provision of the applicable building code that allows for the building official to waive the requirement for the Uncompleted Work. This letter was submitted to the Town on August 12, 2019.
- E. The Town’s building official responded via a certified letter mailed with proof of mailing on September 5, 2019, that the Town would not accept Colorado Code Consultants suggestion of waiving the requirement to complete the Uncompleted Work.
- F. Via the Owner’s attorney Joe Solomon, the Owner filed an appeal on October 3, 2019 (the “**Appeal**”), a copy of which is attached hereto. The Appeal was reviewed by the Town and was initially determined as not a valid appeal as appeals are required to be filed within seven (7) calendar days of the date of the final staff determination according to Section 17.7.8.C of the Town’s Community Development Code. Seven (7) calendar days after the final determination on September 5, 2019 would have been September 12, 2019.
- G. After the Town’s notification that the Appeal was not submitted in a timely manner, the Owner’s representatives have since provided information showing that additional conversations occurred between the Town and the Owner’s representatives which should allow for the Appeal to be considered as a timely submitted appeal.
- H. While the Town does not believe the Appeal was submitted timely, the Town does acknowledge that the Owner’s representatives had additional discussions with the Town regarding the subject matter of the Appeal after September 5, 2019 which may have impacted the Owner’s understanding of the final determination.
- I. Therefore, the Town has determined that it will hear the Appeal according to the procedures set forth in this Agreement and the Owner has agreed to be bound by the terms and conditions of this Agreement.

**Now Therefore**, for good and valuable consideration the parties agree as follows:

1. Appeal. The Town will consider the Appeal as filed on October 3, 2019 by Joe Solomon by submitting it to the Building Board of Appeals. The Appeal shall be limited to the subject matter raised in the Appeal and new matters shall not be considered. The Town will schedule the Appeal to occur within one hundred and twenty (120) days of the date of the Owner paying the appeal fee in the amount of two thousand dollars (\$2,000.00) to the Town. The parties recognize and understand that due to the Covid-19 health crisis that the hearing may need to occur in a virtual setting and consent to the hearing occurring in such a virtual format. The Owner shall be responsible for payment of Owner's costs related to the Appeal and any Town fees and costs, including reasonable attorney's fees, assessed for the appeal pursuant to the Town's Community Development Code and Fee Schedules.
2. Result of Appeal. Owner and the Town agree that both parties shall be bound by the determination of the Building Board of Appeals and agree not to challenge the decision of the Building Board of Appeals. Further, the Owner agrees that if the Building Board of Appeals determines that the Owner must complete the Uncompleted Work, the Owner will undertake and complete the Uncompleted Work prior to the expiration of the New TCO which is set forth below. Failure to do so will subject the Owner to the fines and penalties for violations of the Town's Community Development Code and Municipal Code.
3. New TCO. In conjunction and as consideration of entering into this Agreement, the Town has issued a new temporary certificate of occupancy (the "New TCO") which expires on 10/20/2020.
4. Complete Agreement. This Agreement represents the complete understanding of the parties.
5. Attorney's Fees. In the event of a dispute regarding the terms and condition of this Agreement, the substantially prevailing party shall be entitled to an award of its costs, including attorney's fees.

The parties enter into this Agreement on the day and month first set forth above.

**TOWN OF MOUNTAIN VILLAGE:**

*Kim Montgomery*

\_\_\_\_\_  
Kim Montgomery, Town Manager

**OWNER:**

SFV Mountain View, LLC, a Colorado  
limited liability company

*Daniel Reedy*

\_\_\_\_\_  
Dan Reedy, Manager



## SOLOMON LAW FIRM, P.C.

227 WEST PACIFIC AVENUE, SUITE A (REQUIRED FOR FEDEX)

PO BOX 1748 (REQUIRED FOR ALL U.S. MAIL)

JOSEPH A. SOLOMON, ESQ. TELLURIDE, COLORADO 81435

ATTORNEY AT LAW

E-MAIL: JSOLOMON@MONTROSE.NET

TEL (970) 728-8655

CELL (970) 729-2225

FAX (775) 703-9582

October 3, 2019

Mountain Village Building Board of Appeals  
Town of Mountain Village  
455 Mountain Village Boulevard, Suite A  
Mountain Village, Colorado 81435

Via E-mail to:

Town Building Official Drew Harrington at: Dharrington@mtnvillage.org

Town Clerk Jackie Kennefick at: JKennefick@mtnvillage.org

Re: See Forever Village at The Peaks, Unit GL101  
Appeal of Building Official Determination

Dear Mountain Village Building Board of Appeals:

I represent SFV Mountain View, LLC ("**Mountain View**"), Dan Reedy, Manager, owner of See Forever Village at The Peaks, Unit GL101.

The purpose of this letter is to appeal the determination of Town Building Official Drew Harrington concerning his determination that Mountain View must apply fire-resistant material to the structural beams and columns below Unit GL101 in the parking structure.

### **Background**

See Forever Village at The Peaks is a condominium community established in December 2005.

The original project contemplated that certain unfinished ground floor space would be finished out and used as a restaurant. The project contained a deed restriction to this effect, signed for the benefit of the Town and TSG Ski & Golf Company ("**TSG**"). However, despite efforts, the developer was unable to locate a restaurant operator interested in purchasing and finishing out the space.

As such, in 2016, the developer began exploring with the Town and TSG the possibility of converting the unfinished space to a Residential Unit. Receiving positive feedback, in August 2016, the developer sold the space to Mountain View.

Mountain View then successfully processed an application with the Town to amend the PUD and convert the space to Residential Unit GL101. The application was approved in April 2017.

Mountain View finished out the space, completing the work in January 2018. A Temporary Certificate of Occupancy was issued. See Documents Package, document Mountain View - 4.

### **Unit GL101**

Unit GL101 was issued a temporary certificate of occupancy.

The Town indicated that it would issue a final certificate of occupancy provided Mountain View apply fire-resistant material to the structural beams and columns below Unit GL101 in the parking structure.

Mountain View conferred with Town Building Official Drew Harrington regarding the matter. Enclosed is the correspondence with Mr. Herrington.

As part of its conferral with Mr. Herrington, Mountain View retained Steve Thomas of Colorado Code Consulting, LLC to provide a written opinion concerning the requirement. Enclosed as document Mountain View 6-8 is a copy of Mr. Thomas' August 12, 2019 letter.

As set forth in Mr. Thomas' letter, the structural frame is not required to be provided with any fire protection per Table 601. The IBC requires that the R-2 residential occupancy be separated from the S-2 parking garage by a one-hour occupancy separation per Table 508.4. The existing concrete floor assembly will provide that level of protection per Table 721.1(3), Item 1-1.1. Therefore, the occupancy separation is provided at the floor and wall surfaces.

Although Section 711.4 requires that the structure supporting the horizontal assembly to be protected at the same level as the floor assembly (one-hour), this protection was not required when the building was originally constructed.

Rather, and as shown on the original plans, the . See the page 1 of the original plans, included as documents Mountain View 2-3. Page 3 is a blowup of the note on page 1, which states:

### **ADDITIONAL REQUIREMENTS:**

**AN APPROVED AUTOMATIC SPRINKLER SYSTEM IS REQUIRED TO BE  
INSTALLED IN ACCORDANCE WITH SECTION 903.3.11 OF THE 2000 IBC.**

**STRUCTURAL BEAMS & COLUMNS ARE TO BE INDIVIDUALLY  
FIRE PROTECTED WITH AN AUTOMATIC SPRINKLER SYSTEM  
IN ACCORDANCE WITH SECTION 903.3.11 OF THE IBC.**

The whole parking garage under the San Sophia and Mount Wilson Buildings received a separate final certificate of occupancy in 2007.

As explained by Mr. Thomas, the existing steel in the garage is unprotected throughout the garage as originally approved, and in order to go back and install additional protection, it would

require the removal of ducts, plumbing, electrical, walls and other systems.

Mr. Thomas proposes that the Town accept IBC Section 3408.1, which states in part that the use of existing buildings may change without conforming to all code requirements provided the new use is less hazardous, based on life and fire risk, than the existing use. As explained by Mr. Thomas, the new Group R-2 (residential) occupancy is less hazardous than the previously approved Group A-2 (restaurant) occupancy.

### **September 18, 2019 Meeting and Subsequent Correspondence**

On September 18, 2019, Mr. Reedy then met with Mr. Harrington on site, along with See Forever Engineer Scott Lawshe. The parties reviewed the issue.

Thereafter, at Mr. Reedy's request, Mr. Harrington provided copies of the code sections he was referencing. See documents Mountain View 10-13.

On September 30, 2019, Mr. Reedy asked Mr. Harrington for a written decision. Mr. Harrington responded and included a copy of a letter dated August 20, 2019. However, as stated, Mr. Reedy did not receive the August 20, 2019 letter. The first time Mr. Reedy saw the August 20, 2019 letter was when it was E-mailed to him on September 30, 2019. See documents Mountain View 14-17.

### **Conclusion**

Mountain View requests a hearing before the Mountain Village Building Board of Appeals.

Thank you for your consideration of this appeal.

Sincerely,



Joseph A. Solomon, Esq.

Enc. (Documents Package)

cc:

Dan Reedy, Manager, SFV Mountain View, LLC  
F. John Abrams, President, See Forever Village at The Peaks Homeowners Association, Inc.  
Jeffrey Gibson, Director, See Forever Village at The Peaks Homeowners Association, Inc.  
David Eckman, Eckman Consulting & Management  
Stephen L. Thomas, President, Colorado Code Consulting, LLC

## FIRST AMENDED BUILDING BOARD OF APPEALS HEARING AGREEMENT

This First Amended Building Board of Appeals Hearing Agreement (“First Amended Agreement”) is made and entered into on this 3rd day of November, 2020, by SFV Mountain View, LLC, a Colorado limited liability company (“**Owner**”) and the Town of Mountain Village, a home-rule municipality and political subdivision of the state of Colorado (the “**Town**”).

### RECITALS:

- A. Owner and Town entered into a Building Board of Appeals Hearing Agreement (“Agreement”) on April 22, 2020 under which Owner and Town agreed to certain terms and conditions for Owner’s appeal of the determination of the Town’s building official related to fireproofing garage structural beams and columns.
- B. Due to the COVID-19 disaster emergency, a hearing before the Board of Adjustment (“Board”) cannot be scheduled within the timeframe contemplated by the Agreement.
- C. Owner and Town agree to amend and extend the Agreement as set forth herein to allow more time to schedule the hearing before the Board pursuant to the terms of the Agreement.

**Now Therefore**, for good and valuable consideration the parties agree as follows:

1. Timing for Appeal. Owner and Town agree that the Town will schedule the appeal hearing before the Board to occur as soon as reasonably practicable considering the restrictions resulting from the COVID-19 disaster emergency, but in no event will the appeal hearing occur later than **May 3, 2021**. The parties recognize and understand that due to the COVID-19 health crisis that the hearing may need to occur in a virtual setting and consent to the hearing occurring in such a virtual format. The Owner shall be responsible for payment of Owner’s costs related to the Appeal and any Town fees and costs, including reasonable attorney’s fees, assessed for the appeal pursuant to the Town’s Community Development Code and Fee Schedules.
2. New TCO. In conjunction and as consideration of entering into this First Amended Agreement, the Town will issue a new temporary certificate of occupancy (“TCO”) which expires on **May 3, 2021**.
3. Remainder of Agreement Unchanged. All parts of the Agreement not specifically amended herein remain unchanged and shall continue in full force and effect.

The parties enter into this First Amended Agreement on the day and month first set forth above.

[SIGNATURE PAGE TO FOLLOW]

**TOWN OF MOUNTAIN VILLAGE:**

*Kim Montgomery*

Kim Montgomery, Town Manager

**APPROVED AS TO FORM**

*Paul Wisor*

Paul Wisor, Town Attorney

**OWNER:**

*[Signature]*

SFV Mountain View, LLC, a Colorado  
limited liability company



**From:** Steve Thomas [<mailto:sthomas@coloradocode.net>]  
**Sent:** Monday, August 12, 2019 2:43 PM  
**To:** [dharrington@mtnvillage.org](mailto:dharrington@mtnvillage.org)  
**Cc:** 'David Eckman' <[davide@prosetconstruction.com](mailto:davide@prosetconstruction.com)>; Dan Reedy <[Dan@onshorejupiter.com](mailto:Dan@onshorejupiter.com)>  
**Subject:** See Forever, Unit GL 101 Request

Drew,

It was good to speak with you last week about the above project. I have attached the letter we discussed for your review. Please let me know if you need any additional information or have questions.

Thanks,

Steve Thomas  
President

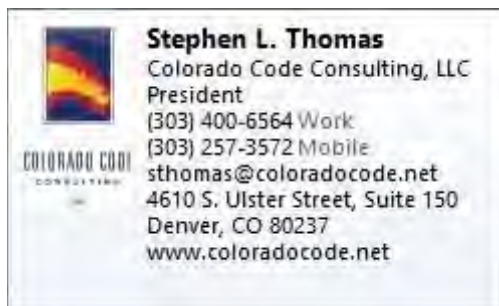

*The information contained in this e-mail message is confidential and may be legally privileged and is intended only for the use of the individual or entity named above. If you are not an intended recipient or if you have received this message in error, you are hereby notified that any dissemination, distribution or copy of this e-mail is strictly prohibited. If you have received this e-mail in error, please immediately notify us by return e-mail or telephone if the sender's phone number is listed above, then promptly and permanently delete this message. Thank you for your cooperation and consideration.*



# Colorado Code Consulting, LLC

## Main Office

4610 S Ulster, Ste. 150  
Denver, CO 80237  
(303) 400-6564  
Fax: (303) 693-0630

## Southern Office

17890 Woodhaven Dr.  
Colorado Springs, CO 80908  
303-895-9988

August 12, 2019

Mr. Drew Harrington  
Building Official  
Town of Mountain Village  
411 Mountain Village Blvd.  
Mountain Village, Colorado 81435

Re: See Forever Village, Unit GL101  
Occupancy Separation Review

Dear Mr. Harrington:

I am writing this letter on behalf of Mr. Dan Reedy, the owner of the above unit. It is my understanding that the project involved a change of occupancy from a Group A-2 restaurant to a Group R-2 Condominium. I also understand that the project is currently under a temporary certificate of occupancy because the occupancy separation between the dwelling unit and the parking garage below has not been completed as shown on the drawings. Mr. David Eckman contacted me for assistance and connected me with the owner. Mr. Reedy requested that I determine if there was any way that the separation would not be required. We had conversations regarding the issue and I believe that there is a case for not requiring the fire protection of the supporting structure for the occupancy separation. This letter is a request that you permit the change of occupancy without requiring the supporting structure to be protected. The references in this letter will be based on the 2012 International Building Code (IBC)

The building appears to be a Type IIB building based on the information I was provided. Therefore, the structural frame is not required to be provided with any fire protection per Table 601. The IBC requires that the R-2 residential occupancy be separated from the S-2 parking garage by a one-hour occupancy separation per Table 508.4. The existing concrete floor assembly will provide that level of protection per Table 721.1(3), Item 1-1.1. Therefore, the occupancy separation is provided at the floor and wall surfaces. However, Section 711.4 requires that the structure supporting the horizontal assembly to be protected at the same level as the floor assembly (one-hour). This protection should have been provided when the building was originally built but wasn't.

The existing steel in the garage is unprotected throughout the garage as originally approved. In order to go back and provide the required protection, it would require the removal of ducts, plumbing, electrical, walls and other systems. It would have a significant impact on the other owners of the building for the benefit of one condominium owner. The owner and contractor did

not realize how much this would cost when the drawings were originally submitted showing the protection of the beams and columns. They are therefore coming to you for this consideration.

We would like to propose that you consider the language in Section 3408.1. This is the section regarding a change of occupancy and requires that the building where the change of occupancy occurs comply with the current code. However, the second sentence states, "Subject to the approval of the building official, the use or occupancy of existing buildings shall be permitted to be changed and the building is allowed to be occupied for purposes in other groups without conforming to all the requirements of this code for those groups, provided the new or proposed use is less hazardous, based on life and fire risk, than the existing use". It is our position that the new Group R-2 occupancy is less hazardous than the previously approved Group A-2 occupancy and that the building official has the authority to make exceptions with supporting documentation.

If you compare the heights and areas of the two occupancies, the Group R-2 occupancy is less hazardous than the Group A-2 occupancy. The tabular height and area in Table 503 for a A-2/Type IIB building is 9,500 SF and 2 stories. The tabular height and area for the R-2/IIB building is 16,000 SF and 4 stories. Based on these two factors the Group R-2 is less hazardous because you can build a larger and taller building than for a Group A-2 occupancy. The occupant load factor is another way to look at the level of risk of life. The occupant load for the assembly space is 15 SF per occupant. However, the load for a residential use is 200 SF per occupant. Therefore, there is a higher risk to life with the larger occupant load in the assembly space versus the residential use.

Another way to evaluate whether one use is less hazardous is within the International Existing Building Code (IEBC). We are not proposing to use this code for this project. However, it has good information that can help with this evaluation. There are three tables in Section 1012 that rate the different occupancies on their relative hazards. The relative hazards are Highest Hazard – 1 and the Lowest Hazard – 5. Table 1012.4 regarding the means of egress rates the two occupancies as the same relative hazard (3). Table 1012.5 covers building height and area hazards. Once again, the table rates the two occupancies as the same relative hazard (2). The last Table 1012.6 addresses exterior openings. It also rates the two occupancies as having the same relative hazard (3). So, by using these tables you can see that the change of occupancy is not being made to a higher hazard.

In addition to using the tables to evaluate the fire and life safety risk in this change of occupancy. Section 1012.5.3 of the IEBC states, "When a change of occupancy classification is made to a higher hazard category as shown in Table 1012.5, fire barriers in separated mixed use buildings shall comply with the fire-resistance requirements of the International Building Code". Even though we are not using this code at this point, it is my opinion that the intent here is that if the change of occupancy is made to an equal or lesser relative hazard for height and area, the occupancy separation would not be required and therefore, the supporting structure would not need to be protected.

Based on the information provided, it is our position that the change of occupancy was to a new occupancy that is less hazardous, based on life and fire risk, than the existing use. Therefore, we would like to request that the supporting beams and columns not be required to be provided with fire-resistant rated protection. The original building was approved and has been allowed without this protection. We believe that we have shown that the second sentence in Section 3408.1 has been met and the building official can choose not to require the protection.

Thank you for the opportunity to evaluate the above issue. All opinions in this report are based on the information provided to our office. We do not accept any responsibility for any condition that

was not known at the time of this report. Colorado Code Consulting, LLC reserves the right to amend this report if additional information is received. It is the responsibility of the registered design professional to ensure compliance with the applicable codes. This letter is advisory only and should not be construed to be approval of any code requirements. Thank you for the opportunity to be of assistance and provide our comments regarding this project. If you need additional information or have any questions, please do not hesitate to call.

Sincerely,

A handwritten signature in black ink, appearing to read 'S. L. Thomas', with a stylized flourish at the end.

Stephen L. Thomas, CBO, CBCO, CHCO  
President



**PLANNING & DEVELOPMENT SERVICES**

455 Mountain Village Blvd. Suite A  
Mountain Village, CO 81435  
970-728-1392  
970-728-4342 Fax  
cd@mtnvillage.org

August 20, 2019

SFV Mountain View LLC A Co LLC  
938 North Old Dixie Highway  
Jupiter, Fl, 33458

Re: See Forever Village, Unit GL101

Dear, Mr. Reedy

Greetings. I have reviewed the document sent to me from Colorado Code Consultants addressing possible alternatives to address the fire-resistant requirement of the structural beams and columns below your unit in the parking structure, a condition of your permit issuance.

Stephen L Thomas the president of Colorado Code Consultants has presented an option not requiring the structural beams to be covered under the existing building code. This option gives me as the Building Official the authority to wave the requirement if I choose too. The approved construction plans for your remodel required the fire assemblies to be maintained, the un-protected structural beams and columns below your unit were addressed during the construction phase of your unit by our previous Building Official Randy Kee.

The TCO issued 12-27-2017 by Randy Kee required the garage ceiling structural beams and columns below your unit in the parking garage to be protected, this was a requirement for the issued TCO and will be required prior to issuing the CO for your unit. Although Stephen Thomas pointed to a code provision that could allow the Building Official to waive this requirement, the town will not be waiving the requirement for the reasons stated in this letter. Primarily that the provision was stamped on your issued plan set and a condition of issuance of the TCO. It was not a new or added condition of building permit approval and would have been considered by your general contractor as part of their bid to perform the work required to change the commercial space to residential occupancy.

Your TCO has been expired as of 4-15-2018 and you are occupying the unit without a CO being issued. The other un-protected structural beams and columns in the parking structure is a separate issue and will be addressed as such. This is a life safety issue that affects the entire structure. In conclusion I will not waive this requirement. The town expects the necessary work to be performed within 60 days of receipt of this correspondence. If the work is not complete and the Town is unable to issue a Certificate of Occupancy, we will refer this issue to the legal department.

Sincerely Drew Harrington

Building Official  
Town Of mountain Village



GENERAL NOTES:

ALL MATERIALS, LABOR, INSTALLATION, FABRICATION, ETC., SHALL CONFORM TO ALL CURRENT GOVERNING CODES REQUIRED BY THE APPROPRIATE JURISDICTIONS(INCLUDING THOSE ABSTRACTS DEALING WITH ENERGY REQUIREMENTS.

EXAMINATION OF THE SITE AND PORTIONS THEREOF, WHICH WILL AFFECT THIS WORK, SHALL BE MADE IMMEDIATELY BY THE GENERAL CONTRACTOR, WHO SHALL COMPARE IT WITH THE DRAWINGS AND SATISFY HIMSELF AS TO CONDITIONS UNDER WHICH WORK IS TO BE PERFORMED.

THE GENERAL CONTRACTOR SHALL BE RESPONSIBLE FOR MEETING THE PROJECT SCHEDULE. THE CONTRACTOR SHALL, PRIOR TO STARTING THE PROJECT, VERIFY ALL LONG LEAD TIME ITEMS AND ESTABLISH A SCHEDULE FOR EACH SUBCONTRACTOR'S WORK.

THE CONTRACTOR SHALL PROTECT THE AREA AND NEW OR EXISTING MATERIALS AND FINISHES FROM DAMAGE WHICH MAY OCCUR FROM CONSTRUCTION, DEMOLITION, DUST, WATER, ETC., AND SHALL PROVIDE AND MAINTAIN TEMPORARY BARRICADES, CLOSURE WALLS, ETC., AS REQUIRED TO PROTECT THE PUBLIC AND OWNERS DURING THE PERIOD OF CONSTRUCTION.

MATERIALS THAT ARE SPECIFIED BY THEIR BRAND NAMES ARE TO ESTABLISH STANDARDS OF QUALITY AND PERFORMANCE. ANY REQUEST FOR SUBSTITUTION SHALL BE SUBMITTED TO THE ARCHITECT FOR REVIEW FOR EQUAL QUALITY AND PERFORMANCE AND SHALL NOT BE PURCHASED OR INSTALLED WITHOUT THEIR WRITTEN APPROVAL.

GENERAL CONTRACTOR SHALL REVIEW AND SUBMIT FINISH SAMPLES, CUT SHEETS AND SHOP DRAWINGS TO THE ARCHITECT FOR REVIEW PRIOR TO ANY FABRICATION OR INSTALLATION. PROVIDE SAMPLES OF ALL FINISHES, INCLUDING BUT NOT LIMITED TO, PAINT, BASE, FLOOR COVERINGS, LAMINATES, SOLID SURFACE MATERIAL, AND MILLWORK FINISHES.

UNLESS OTHERWISE NOTED, ALL DIMENSIONS ON PLAN DRAWINGS ARE FROM FACE OF FINISH AT EXTERIOR WALLS, FROM FACE OF FINISH AT INTERIOR WALLS, OR FROM FACE OF CONCRETE. VERTICAL DIMENSIONS ARE TO TOP OF FINISHED FLOOR OR ROOF SURFACE. VERIFY ALL DIMENSIONS SHOWN ON DRAWINGS BY TAKING MEASUREMENTS. PROPER FIT AND ATTACHMENT OF ALL PARTS IS REQUIRED.

ALL CONSTRUCTION DOCUMENTS ARE COMPLEMENTARY, AND WHAT IS CALLED FOR BY ANY WILL BE BINDING AS IF CALLED FOR BY ALL. ANY WORK SHOWN OR REFERRED TO ON ANY CONSTRUCTION DOCUMENT SHALL BE PROVIDED AS THOUGH ON ALL RELATED DOCUMENTS.

ALL WORK LISTED, SHOWN, OR IMPLIED ON THE CONSTRUCTION DOCUMENTS SHALL BE SUPPLIED AND INSTALLED BY THE GENERAL CONTRACTOR, EXCEPT WHERE NOTED OTHERWISE. THE USE OF THE WORK "PROVIDED" IN CONNECTION WITH ANY ITEM SPECIFIED IS INTENDED TO MEAN THAT SUCH SHALL BE FURNISHED, INSTALLED, AND CONNECTED, WHERE SO REQUIRED, EXCEPT AS NOTED OTHERWISE.

THE CONTRACTOR SHALL MAINTAIN A CURRENT AND COMPLETE SET OF CONSTRUCTION DOCUMENTS ON THE JOB SITE DURING ALL PHASES OF CONSTRUCTION FOR USE OF ALL TRADES AND SHALL PROVIDE ALL SUBCONTRACTORS WITH CURRENT CONSTRUCTION DOCUMENTS, AS REQUIRED.

THE CONTRACTOR SHALL REMOVE ALL RUBBISH AND WASTE MATERIALS ON A REGULAR BASIS, AND SHALL EXERCISE STRICT CONTROL OVER JOB CLEANING TO PREVENT ANY DIRT, DEBRIS OR DUST FROM AFFECTING, IN ANY WAY, FINISHED AREAS IN OR OUTSIDE THE JOB SITE.

THE CONTRACTOR SHALL COORDINATE ALL WORK WITH MECHANICAL, ELECTRICAL, AND PLUMBING DRAWINGS, AND REPORT TO ARCHITECT OR OWNER ANY DISCREPANCIES FOR CORRECTION OR ADJUSTMENT. NO ALLOWANCE WILL BE MADE FOR INCREASE COST INCURRED DUE TO LACK OF PROPER COORDINATION.

THE CONTRACTOR SHALL LEAVE PREMISES AND ALL AFFECTED AREAS CLEAN AND IN AN ORDERLY MANNER READY FOR MOVE IN.

THE CONTRACTOR, OR SUBCONTRACTORS, SHALL SECURE AND PAY FOR ALL PERMITS, GOVERNMENTAL FEES AND LICENSES REQUIRED FOR PROTECTION OF THE WORK. THE CONTRACTOR SHALL REQUEST ALL INSPECTIONS REQUIRED BY LOCAL GOVERNMENTAL AGENCIES AND COORDINATE HIS WORK ACCORDINGLY.

GYPSUM WALLBOARD: ALL INTERIOR WALL AND CEILING FACES ARE TO BE SHEATHED WITH A MINIMUM 5/8" GYPSUM WALL BOARD, WITH JOINTS TAPED, FILLED AND SANDED SMOOTH TO PROVIDE THE LEVEL OF FINISH INDICATED ON DRAWINGS.

INTERIOR PAINT FINISHES: WALLS, CEILINGS, TRIM AND MOULDINGS, DOORS AND FRAMES, SHELVES WINDOW FRAMES AND SITE BUILT MILLWORK SHALL BE PAINTED OR STAINED AS INDICATED. PAINT MATERIALS SHALL BE PREMIUM QUALITY, SHERWIN WILLIAMS OR EQUAL AS APPROVED BY OWNER.

CABINETS & MILLWORK: CABINETS SHALL BE CUSTOM FABRICATED PER ARCHITECT SPECIFICATIONS.

APPLIANCES: ANY APPLIANCES OR EQUIPMENT PROVIDED BY THE CONTRACTOR OR SUBCONTRACTOR SHALL BE U.L. LABELED. CONTRACTOR SHALL PROVIDE TO THE OWNER ALL MANUFACTURER'S STANDARD WRITTEN WARRANTIES, OWNERS MANUALS AND STANDARD ACCESSORIES.

SUBCONTRACTOR SUBMITTALS: CONTRACTORS FOR ELECTRICAL, PLUMBING, FIRE PROTECTION, AND HVAC WORK SHALL SUBMIT DRAWINGS, SPECIFICATIONS, CALCULATION, APPLICATIONS, ETC., AS REQUIRED BY THE BUILDING DEPARTMENT FOR PERMITS AND APPROVALS PRIOR TO STARTING THEIR WORK.

SCOPE OF WORK: THESE PLANS ILLUSTRATE THE NATURE AND SCOPE OF WORK TO BE PERFORMED BY THE GENERAL CONTRACTOR AND ALL SUBCONTRACTORS. ALL WORK SPECIFIED AND/OR IMPLIED IN THESE PLANS, ALL ADDENDA, CHANGE ORDERS, FIELD ORDERS AND SHOP DRAWINGS SHALL BE A PART OF THE CONTRACTORS AGREEMENT.

DISCREPANCIES: DISCREPANCIES BETWEEN DRAWINGS AND/OR SPEC'S SHALL BE REFERRED TO THE PROJECT ARCHITECT FOR CLARIFICATION BEFORE STARTING THE AFFECTED WORK.

INSURANCE: CONTRACTOR SHALL OBTAIN SUCH INSURANCE COVERAGE AS IS REQUIRED BY THE OWNERS AND REGULATORY AUTHORITIES. THE COST OF SAID INSURANCE SHALL BE INCLUDED IN HIS BID.

SHOP DRAWINGS: SHOP DRAWINGS SHALL BE SUBMITTED IN DUPLICATE, FIRST TO GENERAL CONTRACTOR, THEN TO ARCHITECT. SUBSEQUENT TO ARCHITECT'S REVIEW, THEY SHALL BE REVISED AND/OR RESUBMITTED, AS INDICATED.

DOORS: INTERIOR DOORS SHALL BE SOLID WOOD CORE, STYLE AS INDICATED ON DRAWINGS.

GLAZING: ALL GLAZING SHALL CONFORM TO FEDERAL GLAZING REGULATIONS AND THE APPROPRIATE CODE REQUIREMENTS RELATING TO GLAZING. WITHIN 12" OF DOORS, WITHIN 18" OF THE FLOOR SHALL BE FULLY TEMPERED GLASS AND MUST BE PERMANENTLY IDENTIFIED BY THE MANUFACTURER.

FIRE PROTECTION: ALL ASSEMBLIES MUST COMPLY WITH ALL APPLICABLE BUILDING AND FIRE CODE REQUIREMENTS. MONOKOTE-65 OR APPROVED EQUAL MAY BE USED AT SPRAYED FIRE-PROOFING APPLICATIONS PER MANUFACTURER REQUIREMENTS TO MEET REQUIRED FIRE RATING.

GENERAL DEMOLITION NOTES:

PROTECT ALL ITEMS TO REMAIN PRIOR TO COMMENCEMENT OF DEMOLITION. IF ITEMS TO REMAIN ARE SAFER OR THEIR REMOVAL AND REINSTALLATION UPON COMPLETION OF WORK WILL EXPEDITE THE CONSTRUCTION PROCESS, THEN PROCEED ACCORDINGLY. NOTIFY THE ARCHITECT AS THIS CONDITION ARISES.

REPAIR OR REPLACE TO ORIGINAL CONDITION ALL ITEMS DAMAGED DURING THE COURSE OF WORK.

COORDINATE ALL WORK AFFECTING LOAD-BEARING ELEMENTS WITH STRUCTURAL ENGINEER AND SHORE AS REQUIRED.

ANY ELEMENTS UNCOVERED DURING DEMOLITION WHICH WILL AFFECT THE END-CONDITION OF THE PROPOSED WORK MUST BE REPORTED TO THE ARCHITECT IMMEDIATELY UPON THEIR DISCOVERY.

FIELD VERIFY EXISTING DIMENSIONS. REPORT DISCREPANCIES AND/OR ADDITIONAL CONDITIONS WHICH AFFECT PROPOSED WORK TO ARCHITECT PRIOR TO COMMENCEMENT OF WORK.

COORDINATE WITH OWNER ALL ITEMS TO BE SALVAGED. STORAGE LOCATION OF SALVAGED ITEMS, AND FOR ANY ADDITIONAL CONSIDERATIONS THAT NEED TO BE ACCOMMODATED PRIOR TO COMMENCEMENT OF DEMOLITION.

COORDINATE ON SITE ALL DEMOLITION ITEMS TO BE RECYCLED. THEIR PROPER STORAGE AND REMOVAL FROM SITE TO APPROPRIATE FACILITIES.

DASHED AREAS DESIGNATE 'TO BE REMOVED' ON DEMOLITION PLANS ONLY.

FLOOR FINISHES TO REMAIN ARE DESIGNATED ON THE FLOOR PLAN. CONSIDERATION OF ANY OPTION WILL BE GIVEN TO THE CONTRACTOR IF ITEMS DESIGNATED AS 'TO REMAIN' ARE SHOWN TO BE ULTIMATELY LESS EXPENSIVE IF THEY ARE REMOVED AND REPLACED WITH NEW OR REMOVED AND SALVAGED FOR RE-USE RATHER THAN PROTECTED/PATCHED/REPAIRED, ETC. AS REQUIRED DURING THE COURSE OF WORK.

IN AREAS WHERE EXISTING FINISH FLOOR IS TO BE REMOVED, INSPECT EXISTING SUBFLOOR AND REPLACE ANY DAMAGED PORTIONS WITH NEW, TYPICAL.

VERIFY END-CONDITION (REMOVE/SALVAGE/RE-USE) OF ITEMS ATTACHED/BUILT-IN TO PARTITIONS TO BE REMOVED PRIOR TO THEIR REMOVAL. ITEMS TO INCLUDE BUT NOT TO BE LIMITED TO EXISTING DOORS, WINDOWS, SHELVING, ETC.

BREAK OUT ALTERNATES IN BID PACKAGE, TYPICAL.

Comply with the Town of Mountain Village Adopted codes and ordinances 2012 IBC 2012 IRC 2012 IFGC 2012 IPC 2012 IECC 2014 NEC 2012 IMC

SHEET INDEX:

Table with columns for SHEET INDEX, GENERAL, STRUCTURE, ARCHITECTURE, MECHANICAL, ELECTRICAL. Includes rows for A-0, S1.1, S2.1, A-0.1, A-0.2, A-1, A-2, A-3, A-4, A-5, A-6, M-1, M-2, E1, LT1, LT2, LT3.

PROJECT INFORMATION AND CODE SUMMARY:

See Forever Village Unit GL 101 117 Sunny Ridge Place Mountain Village, CO 81435

Project Description: The project site is located at See Forever Village in Mountain Village. The project is a conversion of an existing garden level restaurant shell space (A-2 Occupancy) to a private residential condominium unit (R-2 Occupancy) within a five-story condo building.

Table with columns for Applicable Codes and corresponding code references like 2012 IBC, 2014 NEC, 2012 IFGC, etc.

Existing Building Information: OCCUPANCY GROUPS: MIXED: R-2 (RESIDENTIAL), S-2 (PARKING GARAGE), A-2 (RESTAURANT) CONSTRUCTION TYPE: TYPE I-B (FULLY SPRINKLERED)

Proposed Project Area: OCCUPANCY GROUPS: CONVERT A-2 (RESTAURANT) INTO R-2 (RESIDENTIAL) CONSTRUCTION TYPE: TYPE I-B (FULLY SPRINKLERED)

Required Separations: FROM S-2 TO R-2 = 2 HRS FROM S-2 TO A-2 = 2 HRS FROM R-2 TO R-2 = 1 HR

Section 420.2 Separation walls. Walls separating dwelling units in the same building, walls separating sleeping units in the same building, and walls separating dwelling or sleeping units from other occupancies contiguous to them in the same building shall be constructed as fire partitions in accordance with Section 706.

Section 420.4. Group R occupancies shall be equipped throughout with an automatic sprinkler system in accordance with Section 903.2.8.

Section 510.7.1 Fire Separation: Parking occupancy and upper occupancy separation to comply with Table 508.4. Fire barriers to be constructed in accordance with Section 707 and/or Section 711 for horizontal assemblies.

Types of Construction: Types IIB and IA Construction require all building elements listed in Table 601 to be of non-combustible materials except as permitted in Section 603 and elsewhere in the code.

Section 603.1 Allowable Materials 1. Fire-retardant-treated wood shall be permitted in: 1.1. Nonbearing partitions where the required fire-resistance rating is 2 hours or less.

Reviewed Plans Reviewed plans are not approved plans. Inspectors may require modification as necessary to meet ordinance or building code provisions on the job.

OWNER: ONSHORE CONSTRUCTION AND DEVELOPMENT INC. ARCHITECT: LAURA P. MEARS, AIA STRUCTURAL ENGINEER: MONROE & NEWELL ENGINEERS, INC. MECHANICAL ENGINEER: HUGHES CONSULTING ENGINEERING GENERAL CONTRACTOR: BRIDGER CONSTRUCTION SERVICES, INC.

See Forever Village Unit GL101 Mountain Village Colorado 81435

SEE FOREVER INTERIOR MODIFICATIONS

Vertical sidebar containing: STATE OF COLORADO LICENSED ARCHITECT LAURA P. MEARS, ONSHORE CONSTRUCTION AND DEVELOPMENT, INC., INTERIOR MODIFICATIONS, and drawing title information.



**GENERAL STRUCTURAL NOTES**

**1. LIVE LOADS USED IN DESIGN:**

|                                     |         |
|-------------------------------------|---------|
| A. ROOF                             | 75 PSF  |
| B. IMPORTANCE FACTORS               |         |
| CATEGORY                            | II      |
| SEISMIC FACTOR I <sub>E</sub>       | 1.0     |
| SNOW FACTOR I <sub>S</sub>          | 1.0     |
| WIND FACTOR I <sub>M</sub>          | 1.0     |
| C. WIND                             |         |
| 3 SECOND GUST (ASCE 7-18)           | 115 MPH |
| 3 SECOND GUST (ASCE 7-05)           | 90 MPH  |
| FASTEST MILE EXPOSURE               | 70 MPH  |
| D. SNOW                             |         |
| GROUND SNOW LOAD P <sub>g</sub>     | 130 PSF |
| FLAT ROOF SNOW LOAD P <sub>f</sub>  | 75 PSF  |
| SNOW EXPOSURE FACTOR C <sub>e</sub> | 1.0     |
| THERMAL FACTOR C <sub>t</sub>       | 1.0     |

**E. SEISMIC**

|                     |       |
|---------------------|-------|
| SITE CLASS CATEGORY | C     |
| SS                  | 0.211 |
| SS                  | 0.056 |
| S <sub>DS</sub>     | 0.169 |
| S <sub>D1</sub>     | 0.063 |

BASIC SEISMIC FORCE RESISTING SYSTEM IS ORDINARY REINFORCED CONCRETE BEARING WALLS

|                                              |                          |
|----------------------------------------------|--------------------------|
| SEISMIC RESPONSE COEFFICIENTS C <sub>s</sub> | 0.0422                   |
| RESPONSE MODIFICATION FACTOR R               | 4.0                      |
| ANALYSIS PROCEDURE USED                      | EQUIVALENT LATERAL FORCE |

**F. LIVE LOADS ARE REDUCED PER CODE IF APPLICABLE.**

**G. CODE USED IN DESIGN:**

2012 IBC.

**2. TESTING, INSPECTIONS AND OBSERVATIONS:**

A. THE STRUCTURAL ENGINEER DOES NOT PROVIDE INSPECTIONS OF CONSTRUCTION. STRUCTURAL ENGINEER MAY MAKE PERIODIC OBSERVATIONS OF THE CONSTRUCTION; SUCH OBSERVATIONS SHALL NOT REPLACE REQUIRED INSPECTIONS BY THE GOVERNING AUTHORITIES OR SERVICE AS "SPECIAL INSPECTIONS" AS MAY BE REQUIRED BY CHAPTER 17 OF THE INTERNATIONAL BUILDING CODE.

B. THE FOLLOWING WORK SHALL BE INSPECTED BY THE SPECIAL INSPECTOR UNLESS SPECIFICALLY WAIVED BY THE BUILDING OFFICIAL.

**1. SOIL PREPARATION**

a. EARTHWORK EXCAVATION, PLACEMENT AND COMPACTION OF FILL AND IN-PLACE DRY DENSITY OF THE COMPACTED FILL FOR CONFORMANCE WITH THE APPROVED REPORT.

**2. CONCRETE CONSTRUCTION**

- a. PERIODIC INSPECTION OF REINFORCING STEEL.
- b. CONTINUOUS INSPECTION OF PLACEMENT OF SHEAR REINFORCEMENT.
- c. PERIODIC VERIFICATION OF WELDABILITY OF REINFORCING STEEL OTHER THAN ASTM A706.
- d. CONTINUOUS INSPECTION OF REINFORCING STEEL-RESISTING FLEXURAL AND AXIAL FORCES IN INTERMEDIATE, AND BOUNDARY ELEMENTS OF SPECIAL REINFORCED CONCRETE SHEAR WALLS AND SHEAR REINFORCEMENT.
- e. CONTINUOUS INSPECTION OF BOLTS TO BE INSTALLED IN CONCRETE PRIOR TO AND DURING PLACEMENT OF CONCRETE.
- f. PERIODIC VERIFICATION OF USE OF REQUIRED DESIGN MIX.
- g. CONTINUOUS INSPECTION AT THE TIME FRESH CONCRETE IS SAMPLED TO FABRICATE SPECIMENS FOR STRENGTH TESTS, PERFORM SLUMP AND AIR CONTENT TESTS AND DETERMINE THE TEMPERATURE OF THE CONCRETE.
- h. CONTINUOUS INSPECTION OF CONCRETE PLACEMENT FOR PROPER APPLICATION TECHNIQUES.
- i. PERIODIC INSPECTION FOR MAINTENANCE OF SPECIFIED CURING TEMPERATURE AND TECHNIQUES.
- j. PERIODIC INSPECTION OF THE ERECTION OF PRECAST CONCRETE MEMBERS.

**3. MASONRY CONSTRUCTION**

a. THE MINIMUM SPECIAL INSPECTION PROGRAM FOR MASONRY IN NON-ESSENTIAL FACILITIES SHALL BE AS FOLLOWS:

- 1. FROM THE BEGINNING OF MASONRY CONSTRUCTION, THE FOLLOWING SHALL BE VERIFIED TO ENSURE COMPLIANCE:
  - a. PROPORTIONS OF SITE-PREPARED MORTAR AND GROUT. (PERIODICALLY)
  - b. PLACEMENT OF MASONRY UNITS AND CONSTRUCTION OF MORTAR JOINTS. (PERIODICALLY)
  - c. PLACEMENT OF REINFORCEMENT AND CONNECTORS. (PERIODICALLY)
  - d. GROUT SPACE PRIOR TO GROUTING. (CONTINUOUSLY)
  - e. PLACEMENT OF GROUT. (CONTINUOUSLY)

**2. THE INSPECTION PROGRAM SHALL VERIFY:**

- a. SIZE AND LOCATION OF STRUCTURAL ELEMENTS. (PERIODICALLY)
- b. TYPE, SIZE AND LOCATION OF ANCHORS, INCLUDING OTHER DETAILS OF ANCHORAGE OF MASONRY TO STRUCTURAL MEMBERS, FRAMES OR OTHER CONSTRUCTION. (CONTINUOUSLY)
- c. SPECIFIED SIZE, GRADE AND TYPE OF REINFORCEMENT. (PERIODICALLY)
- d. WELDING OF REINFORCEMENT. (PERIODICALLY)
- e. PROTECTION OF MASONRY DURING COLD WEATHER (TEMPERATURE BELOW 40 DEGREES F) OR HOT WEATHER (TEMPERATURE ABOVE 90 DEGREES F). (PERIODICALLY)

**3. PREPARATION OF ANY REQUIRED GROUT SPECIMENS, MORTAR SPECIMENS AND/OR PRISMS SHALL BE OBSERVED. (CONTINUOUSLY)**

**4. COMPLIANCE WITH REQUIRED INSPECTION PROVISIONS OF THE CONSTRUCTION DOCUMENTS AND THE APPROVED SUBMITTALS SHALL BE VERIFIED. (PERIODICALLY)**

**3. FOUNDATIONS**

- A. REFER TO GEOTECHNICAL REPORTS BY: BUCHHORN GEOTECH, REPORT NO. 04-895-020 DATED MARCH 2004, AND WESTERN TECHNOLOGIES INC., REPORT NO. 31283C 005 DATED FEBRUARY 26, 1998.
- B. ALL BOTTOMS OF GRADE BEAMS AND FOUNDATIONS SHALL BE A MINIMUM OF 48" BELOW EXTERIOR GRADE.
- C. ALLOWABLE BEARING PRESSURE = 2000 PSF
- D. CONTRACTOR TO PROVIDE, AT HIS EXPENSE, FIELD DENSITY TESTS ON COMPACTED FILL UNDER EACH SECTION OF FOOTING OR SLABS-ON-GRADE.
- E. NOTIFY SOILS ENGINEER WHEN EXCAVATION IS COMPLETED SO THAT CONDITIONS MAY BE INSPECTED PRIOR TO PLACEMENT OF ANY FILL OR CONCRETE.

**4. SLAB ON GRADE**

- A. THE SLAB ON GRADE SELECTED BY THE OWNER AT THE GROUND FLOOR LEVEL OF THIS BUILDING HAS SOME RISK OF MOVEMENT. THE SLAB OPTION CHOSEN AS PROVIDING SUITABLE PERFORMANCE AT A REASONABLE COST REQUIRES 2 FEET OF OVER-EXCAVATED FILL TO BE PLACED. REFERENCE THE PROJECT SOILS REPORT FOR SPECIFIC REQUIREMENTS.
- B. THE PREPARATION OF THE SUBGRADE FOR THE SLAB ON GRADE SHALL BE IN STRICT ACCORDANCE WITH THE PROJECT SOILS REPORT REFERENCED ABOVE. THE CONTRACTOR SHALL DIRECT QUESTIONS REGARDING THE SUBGRADE PREPARATION REQUIREMENTS TO THE GEOTECHNICAL ENGINEER.

- C. MOVEMENT OF THE SLAB ON GRADE MAY CAUSE DAMAGE TO ANYTHING CONNECTED TO BOTH THE SLAB AND OTHER PORTIONS OF THE SUPERSTRUCTURE. ISOLATION DETAILS FOR PARTITION WALLS, BASECOURSES, PIPING AND OTHER ITEMS MAY BE REQUIRED. REFER TO THE APPROPRIATE DRAWINGS OR CONSULT WITH THE RESPONSIBLE MEMBER OF THE DESIGN TEAM PRIOR TO CONNECTING ITEMS TO BOTH THE SLAB ON GRADE AND OTHER PORTIONS OF THE SUPERSTRUCTURE.

**5. CONCRETE**

A. ALL CAST-IN-PLACE CONCRETE SHALL BE MADE WITH TYPE I/II PORTLAND CEMENT, STONE AGGREGATE AND SHALL SATISFY THE FOLLOWING REQUIREMENTS:

CONCRETE ITEM F'C MIX TYPE MAX W/C RATIO % AIR REQ.

FOUNDATION WALLS 4000 psi STD --- ---

EXTERIOR CONCRETE (\*) 4500 psi STD 0.45 65-85

\* MAXIMUM SLUMP SHALL NOT EXCEED 4".

B. CONTRACTOR SHALL SAWCUT OR TROMPELOUT JOINTS IN SLABS ON GRADE. JOINTS SHALL BE SPACED 15 FEET AND SAWCUT OR TROMPELOUT 1/4 OF SLAB DEPTH X 3/16" WIDE WITHIN 12 HOURS AFTER POURING. CARRY ALL SLAB REINFORCEMENT THROUGH JOINT.

C. SLABS, TOPPING, FOOTINGS, BEAMS AND WALLS SHALL NOT HAVE JOINTS IN A HORIZONTAL PLANE. ANY STOP IN CONCRETE WORK MUST BE MADE AT THIRD POINT OF SPAN WITH VERTICAL BULKHEADS AND HORIZONTAL SHEAR KEYS UNLESS OTHERWISE SHOWN. ALL CONSTRUCTION JOINTS SHALL BE AS DETAILED OR AS REVIEWED BY THE ENGINEER.

D. ALL CONCRETE WORK AND REINFORCEMENT DETAILING SHALL BE IN ACCORDANCE WITH ACI BUILDING CODE 318 LATEST EDITION, UNLESS NOTED OTHERWISE. USE STANDARD HOOKS FOR DOCKELS UNLESS NOTED OTHERWISE. ALL EXPOSED EDGES OF CONCRETE WORK SHALL HAVE 3/4" INCH CHAMFER.

**6. REINFORCEMENT**

A. ALL REINFORCING SHALL BE HIGH-STRENGTH DEFORMED BARS CONFORMING TO ASTM A615, GRADE 60 EXCEPT TIES, STIRRUPS AND PLATE ANCHORS WHICH SHALL BE DEFORMED BARS, ASTM DESIGNATION A615, GRADE 40 OR ASTM A706 GRADE 60.

B. WELDED WIRE FABRIC SHALL CONFORM TO ASTM A185 GRADE 65 AND SHALL BE LAPPED ONE FULL MESH AT SIDE AND END SPLICES AND WELDED TOGETHER.

C. REINFORCEMENT PROTECTION UNLESS NOTED OTHERWISE:

- 1. CONCRETE POURED AGAINST EARTH 3"
- 2. CONCRETE POURED IN FORMS (EXPOSED TO WEATHER OR EARTH) 2"
- 3. COLUMNS AND BEAMS (TIE BARS) 1-1/2"
- 4. SLABS AND WALLS (NOT EXPOSED TO WEATHER) 3/4"

D. REINFORCEMENT PLACEMENT AND TOLERANCES SHALL BE IN ACCORDANCE WITH SECTIONS 7.5, 7.6 AND 7.7 OF ACI 318, LATEST EDITION.

E. NO SPLICES OF REINFORCEMENT SHALL BE MADE EXCEPT AS DETAILED OR AUTHORIZED BY THE STRUCTURAL ENGINEER. LAP SPLICES, WHERE PERMITTED, SHALL BE A MINIMUM OF 48 BAR DIAMETERS FOR #6 BARS AND SMALLER AND SHALL BE A MINIMUM OF 80 BAR DIAMETERS FOR #7 AND #8 REINFORCEMENT UNLESS NOTED OTHERWISE. MAKE ALL BARS CONTINUOUS AROUND CORNERS.

F. PLACE TWO #5 (PER 8" THICKNESS) WITH 2'-0" PROJECTION AROUND ALL OPENINGS IN CONCRETE WALLS, SLABS, AND BEAMS. ALSO PROVIDE TWO #5 X 4'-0" DIAGONALLY AT EACH CORNER.

G. CONTINUOUS TOP AND BOTTOM BARS IN WALLS AND BEAMS SHALL BE SPLICED AS FOLLOWS: TOP BARS AT MIDSPAN, BOTTOM BARS OVER SUPPORTS.

**7. MASONRY**

A. ALL MASONRY CONSTRUCTION REQUIRES SPECIAL INSPECTIONS PER CHAPTER 17 OF THE INTERNATIONAL BUILDING CODE.

B. CONCRETE BLOCK UNITS SHALL CONFORM TO ASTM C90, GRADE N. MORTAR SHALL BE ASTM C270 TYPE S OR M.

C. MASONRY SHALL CONSIST OF CONCRETE BLOCK WITH A MINIMUM COMPRESSIVE STRENGTH OF F'm OF 1900 PSI BASED ON NET AREA.

D. WALLS SHALL BE REINFORCED HORIZONTALLY AT 16" ON CENTER WITH 9 GAGE MINIMUM LADDER-TYPE REINFORCEMENT MEETING ASTM A82 MASONRY WALL REINFORCEMENT. HORIZONTAL REINFORCEMENT SHALL BE CONTINUOUS AROUND CORNERS.

E. UNLESS NOTED OTHERWISE, MASONRY WALLS SHALL ALSO BE REINFORCED WITH ONE #5 VERTICALLY AT WALL ENDS, CORNERS, EACH SIDE OF DOOR OR WINDOW OPENINGS AND AT NOT OVER 4 FEET ON CENTER TYPICALLY. REINFORCEMENT SHALL BE FULLY GROUTED IN PLACE. GROUT SHALL DEVELOP 3000 PSI IN 28 DAYS AND MEET ASTM C476.

F. ALL CMU WALLS REQUIRE A MINIMUM OF 2-#5 IN BOND BEAM ABOVE ALL DOORS AND WINDOWS, AT FLOOR AND ROOF LINES, AND TOP OF PARAPETS UNLESS OTHERWISE NOTED.

G. REFER TO ARCHITECTURAL DRAWINGS FOR CONSTRUCTION JOINT LOCATIONS.

H. FILL ALL VOIDS AND BLOCK CELLS SOLIDLY WITH ASTM C476 GROUT FOR A DISTANCE OF 24" BENEATH AND A MINIMUM OF 16" EACH SIDE OF ALL BEAM REACTIONS OR OTHER CONCENTRATED LOADS UNLESS NOTED OTHERWISE.

I. CMU SHALL BE FULLY GROUTED BELOW GRADE.

**8. STRUCTURAL STEEL**

A. ALL STRUCTURAL STEEL SHALL CONFORM TO ASTM A36 EXCEPT WIDE FLANGE BEAMS WHICH SHALL CONFORM TO ASTM 992, (98 KSI) AND EXCEPT PIPE COLUMNS WHICH SHALL CONFORM TO ASTM A53 AND TUBE COLUMNS TO ASTM A500, GRADE B, LATEST EDITIONS. STEEL SUPPLIER MAY PROVIDE ASTM A572, GRADE 50 AT HIS OPTION. MISCELLANEOUS EMBEDDED ITEMS SHALL BE A36 STEEL.

B. ALL STRUCTURAL BOLTS SHALL BE A325N INSTALLED TO A MINIMUM SNUG TIGHT CONDITION. ALL ANCHOR BOLTS SHALL CONFORM TO ASTM A307 UNLESS NOTED OTHERWISE.

C. STRUCTURAL STEEL SHALL BE DETAILED AND FABRICATED IN ACCORDANCE WITH THE LATEST PROVISIONS OF AISC "MANUAL OF STEEL CONSTRUCTION."

D. PROVIDE ALL EMBEDDED ITEMS IN STRUCTURE AS NOTED ON ARCHITECTURAL, MECHANICAL, ELECTRICAL AND STRUCTURAL DRAWINGS. MISCELLANEOUS EMBEDDED ITEMS AND ANCHOR BOLTS SHALL BE FURNISHED BY STEEL SUPPLIER AND INSTALLED BY CONCRETE CONTRACTOR. STEEL SHALL FULFILL ASTM A36.

E. PROVIDE ASPHALTIC MASTIC COATING ON ALL STEEL EXPOSED TO EARTH.

F. SUBMIT SHOP AND ERECTION DRAWINGS TO ENGINEER FOR REVIEW OF ALL CONCRETE REINFORCING AND STRUCTURAL STEEL THE MANUFACTURING OR FABRICATION OF ANY ITEMS PRIOR TO WRITING REVIEW OF SHOP DRAWINGS WILL BE ENTIRELY AT THE RISK OF THE CONTRACTOR.

G. WATERPROOFING, VAPOR BARRIERS, WATERSTOP, ETC., SHALL BE AS SHOWN ON THE ARCHITECTURAL DRAWINGS AND AS INDICATED IN THE SPECIFICATIONS.

H. ALL MASONRY AND STONE VENEERS SHALL BE ATTACHED TO INTERIOR AND EXTERIOR WALLS AS SPECIFIED IN SECTION 3400 OF THE INTERNATIONAL BUILDING CODE.

I. ALL DIMENSIONS ON STRUCTURAL DRAWINGS SHALL BE CHECKED AGAINST FIELD AND ARCHITECTURAL DRAWINGS.

**9. GENERAL**

A. ENGINEERS ACCEPTANCE MUST BE SECURED FOR ALL STRUCTURAL SUBSTITUTIONS.

B. VERIFY ALL OPENINGS THROUGH FLOORS, AND WALLS WITH MECHANICAL AND ELECTRICAL CONTRACTORS. VERIFICATION OF LOCATIONS, SIZES, LINTELS AND REQUIRED CONNECTIONS ARE CONTRACTOR'S COMPLETE RESPONSIBILITY.

C. PRIOR TO INSTALLATION OF MECHANICAL AND ELECTRICAL EQUIPMENT OR OTHER ITEMS TO BE ATTACHED TO THE STRUCTURE, ENGINEER'S APPROVAL OF CONNECTIONS AND SUPPORTS SHALL BE OBTAINED. UNLESS SPECIFICALLY DETAILED ON ARCHITECTURAL AND STRUCTURAL DRAWINGS, RESPECTIVE SUBCONTRACTOR SHALL FURNISH ALL HANGERS, CONNECTIONS, ETC., REQUIRED FOR INSTALLATION OF HIS ITEMS.

D. PROVIDE ALL EMBEDDED ITEMS IN STRUCTURE AS NOTED ON ARCHITECTURAL, MECHANICAL, ELECTRICAL AND STRUCTURAL DRAWINGS. MISCELLANEOUS EMBEDDED ITEMS AND ANCHOR BOLTS SHALL BE FURNISHED BY STEEL SUPPLIER AND INSTALLED BY CONCRETE CONTRACTOR. STEEL SHALL FULFILL ASTM A36.

E. PROVIDE ASPHALTIC MASTIC COATING ON ALL STEEL EXPOSED TO EARTH.

F. SUBMIT SHOP AND ERECTION DRAWINGS TO ENGINEER FOR REVIEW OF ALL CONCRETE REINFORCING AND STRUCTURAL STEEL THE MANUFACTURING OR FABRICATION OF ANY ITEMS PRIOR TO WRITING REVIEW OF SHOP DRAWINGS WILL BE ENTIRELY AT THE RISK OF THE CONTRACTOR.

G. WATERPROOFING, VAPOR BARRIERS, WATERSTOP, ETC., SHALL BE AS SHOWN ON THE ARCHITECTURAL DRAWINGS AND AS INDICATED IN THE SPECIFICATIONS.

H. ALL MASONRY AND STONE VENEERS SHALL BE ATTACHED TO INTERIOR AND EXTERIOR WALLS AS SPECIFIED IN SECTION 3400 OF THE INTERNATIONAL BUILDING CODE.

I. ALL DIMENSIONS ON STRUCTURAL DRAWINGS SHALL BE CHECKED AGAINST FIELD AND ARCHITECTURAL DRAWINGS.

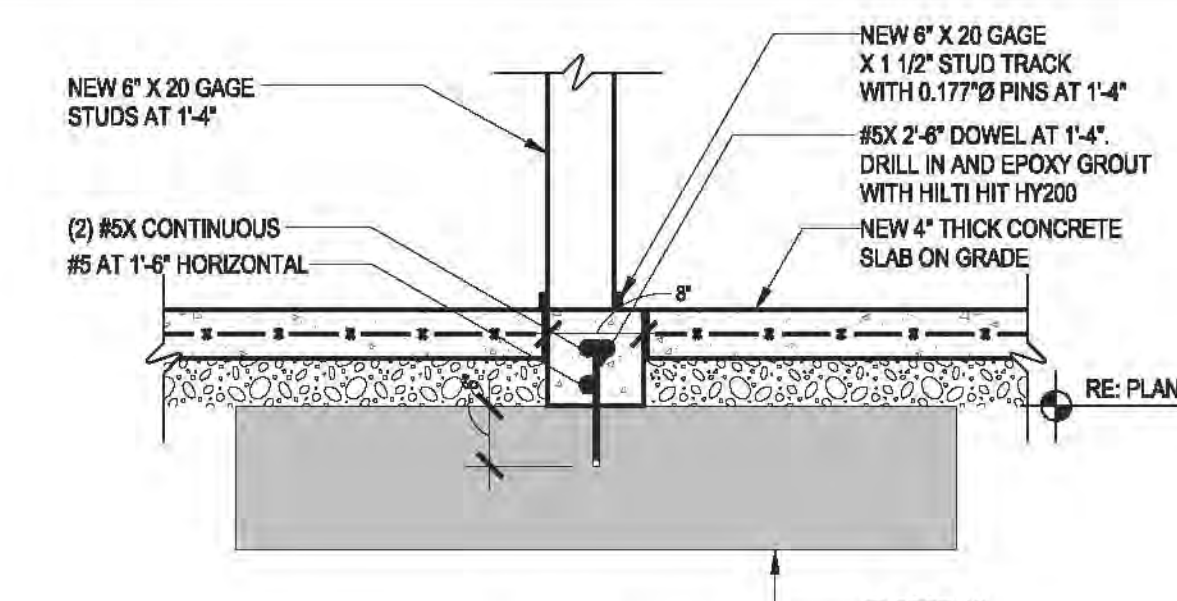

**SECTION 9**  
3/4" = 1'-0"

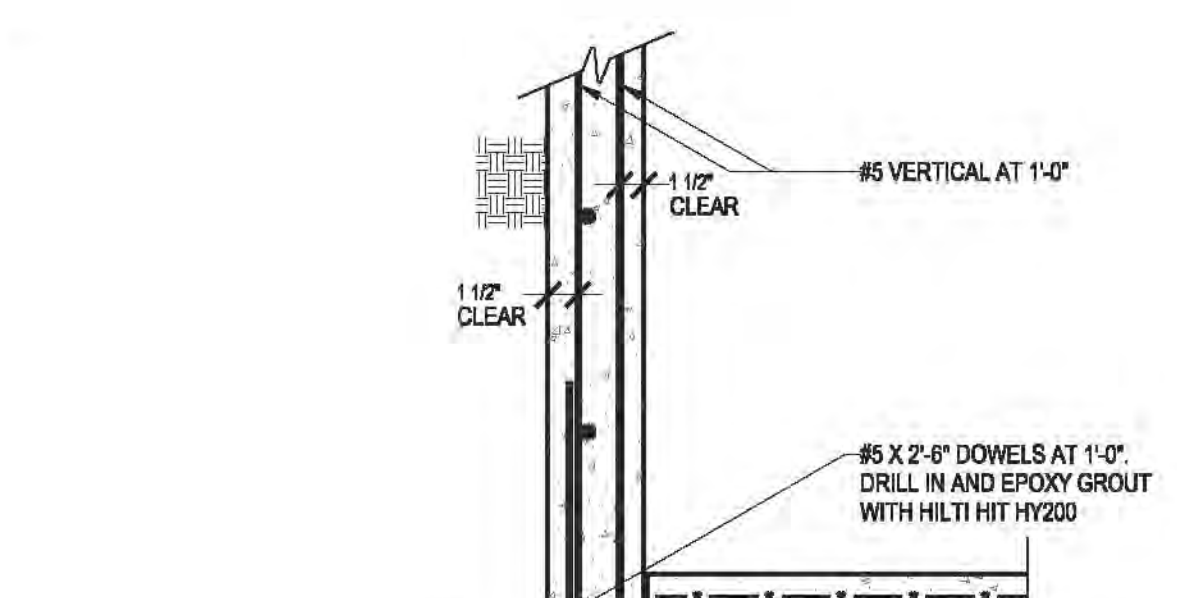

**SECTION 10**  
3/4" = 1'-0"

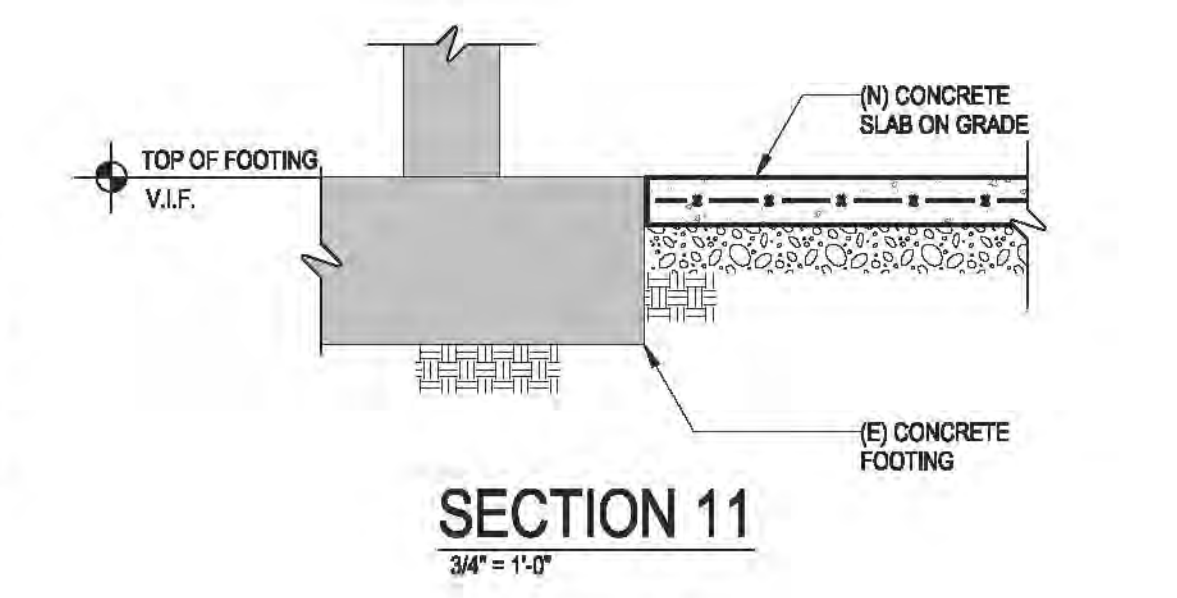

**SECTION 11**  
3/4" = 1'-0"

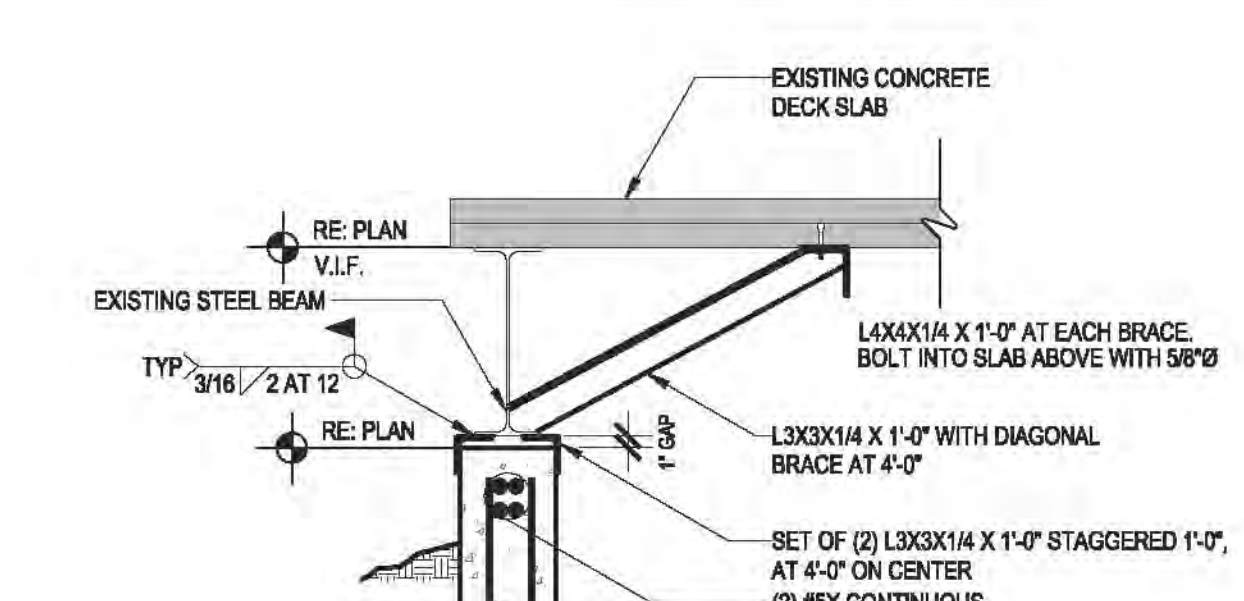

**SECTION 5**  
3/4" = 1'-0"

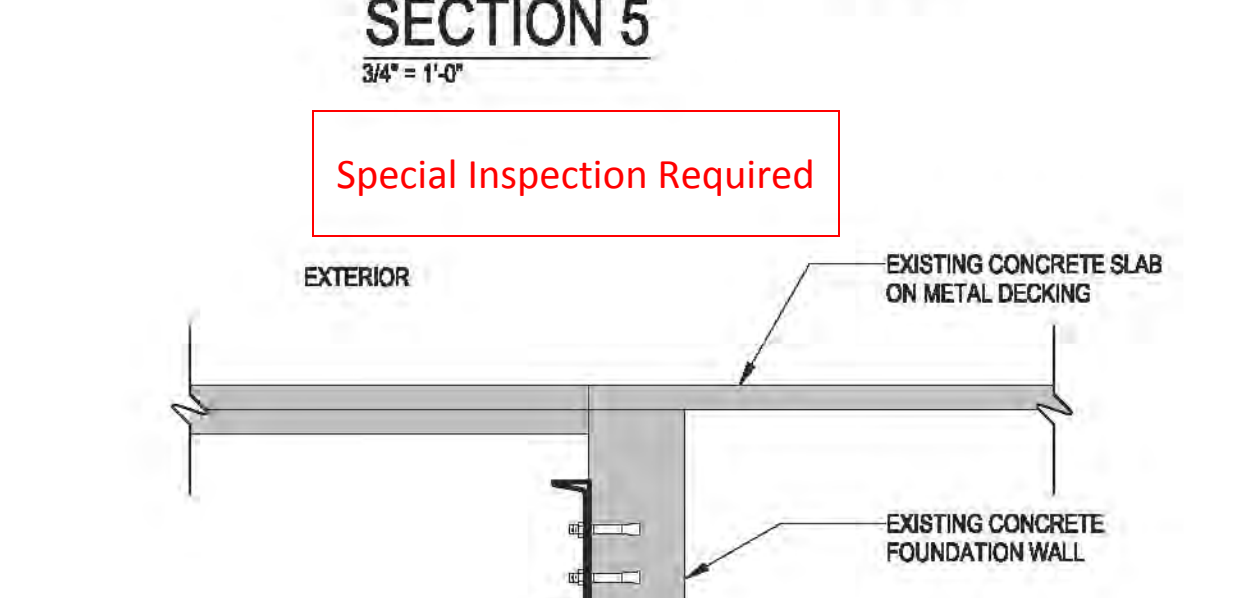

**SECTION 6**  
3/4" = 1'-0"

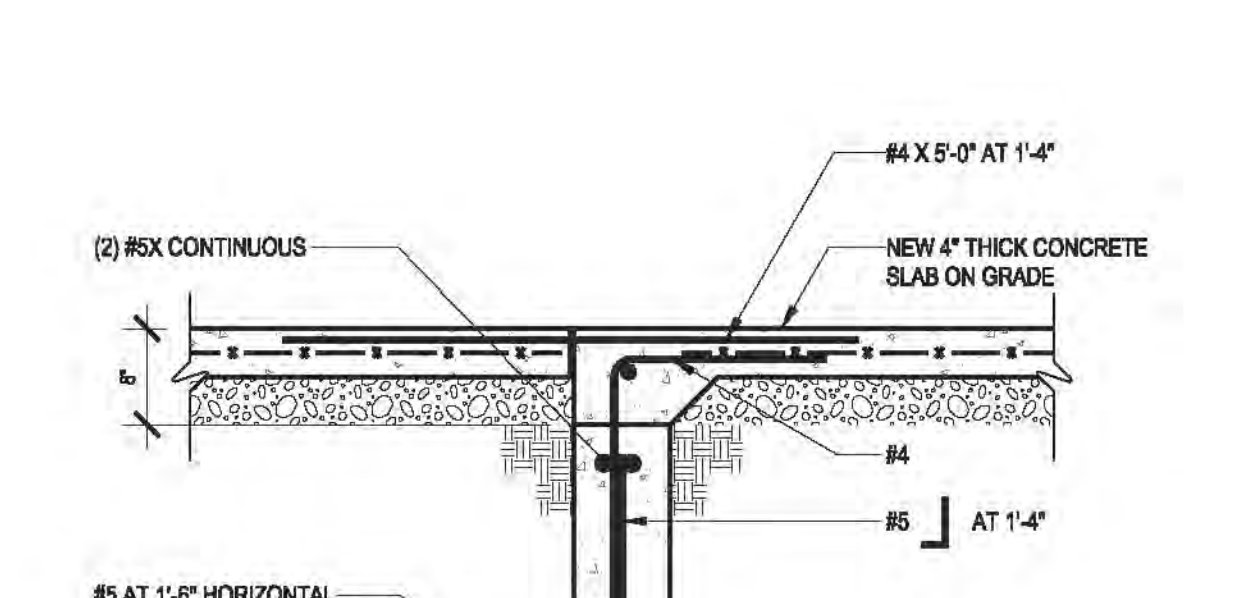

**SECTION 7**  
3/4" = 1'-0"

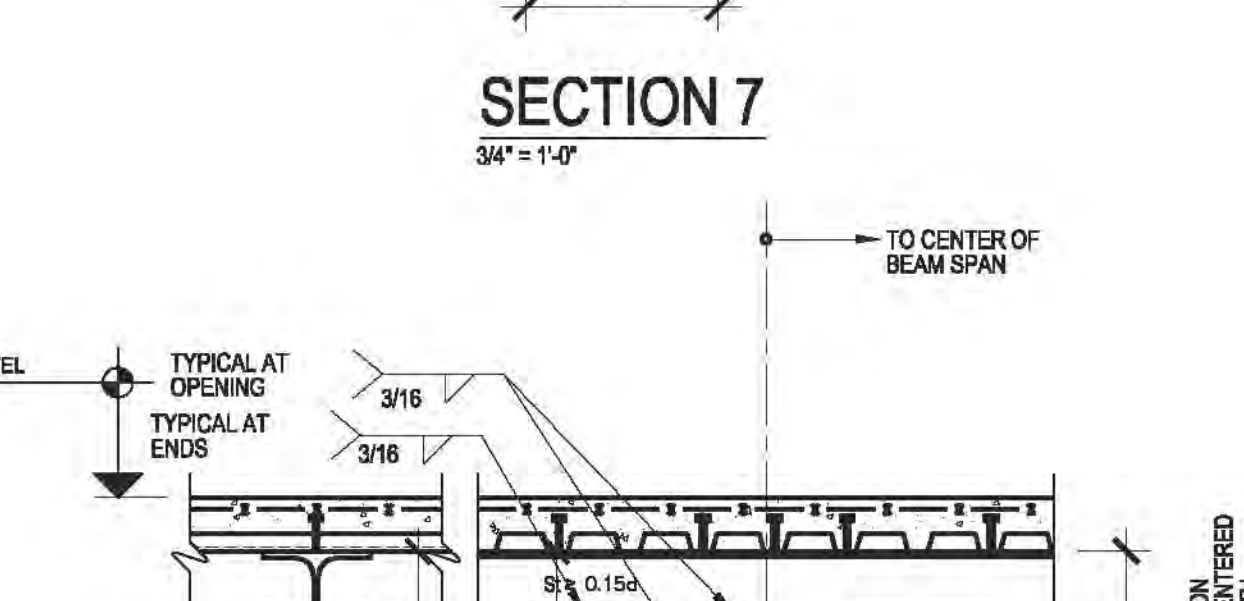

**SECTION 8**  
3/4" = 1'-0"

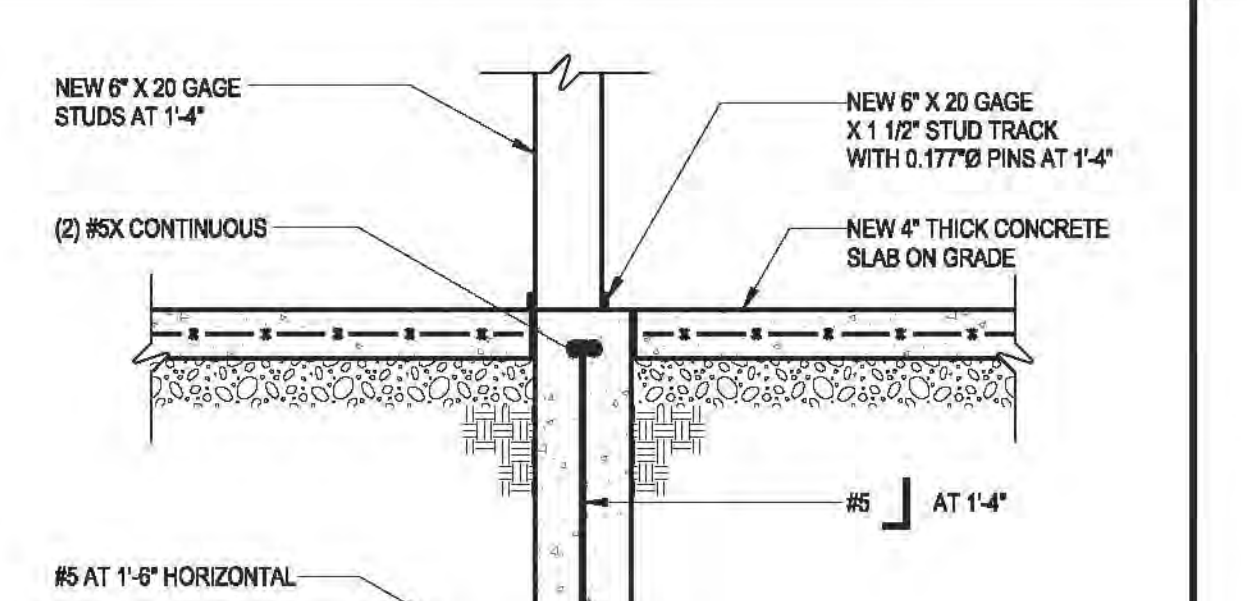

**SECTION 1**  
3/4" = 1'-0"

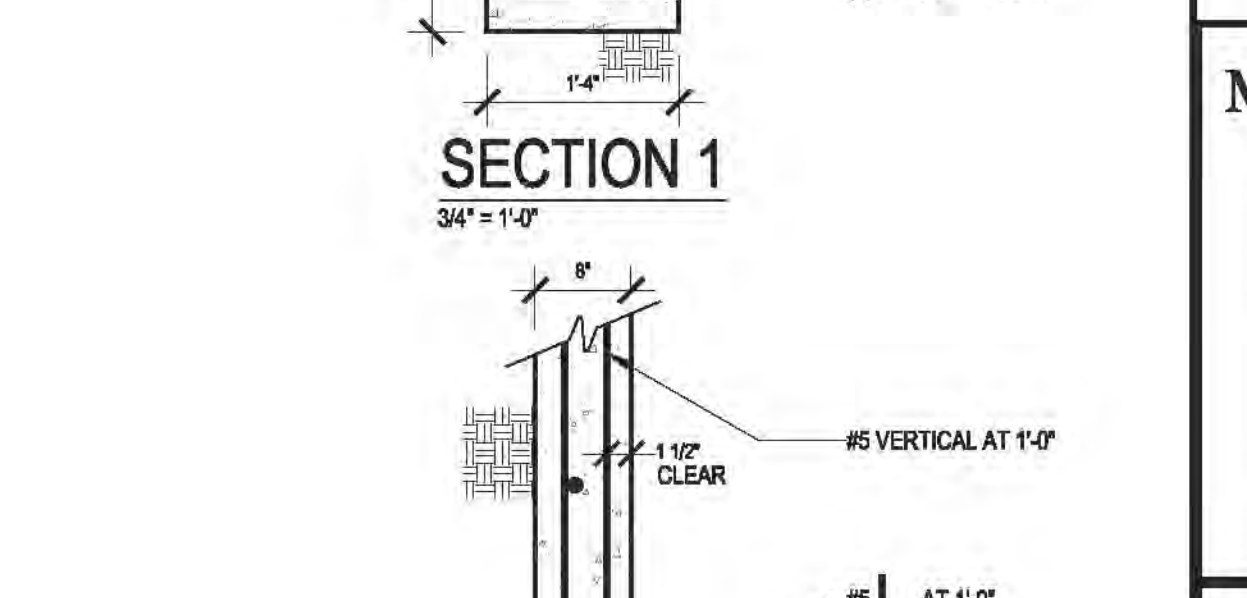

**SECTION 2**  
3/4" = 1'-0"

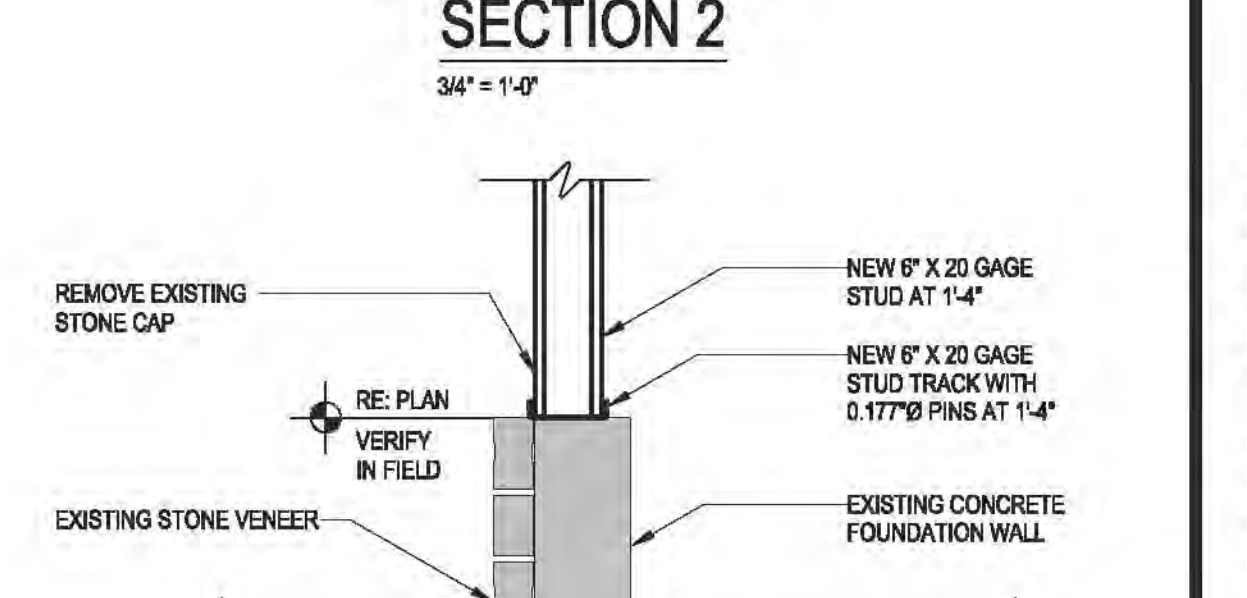

**SECTION 3**  
3/4" = 1'-0"

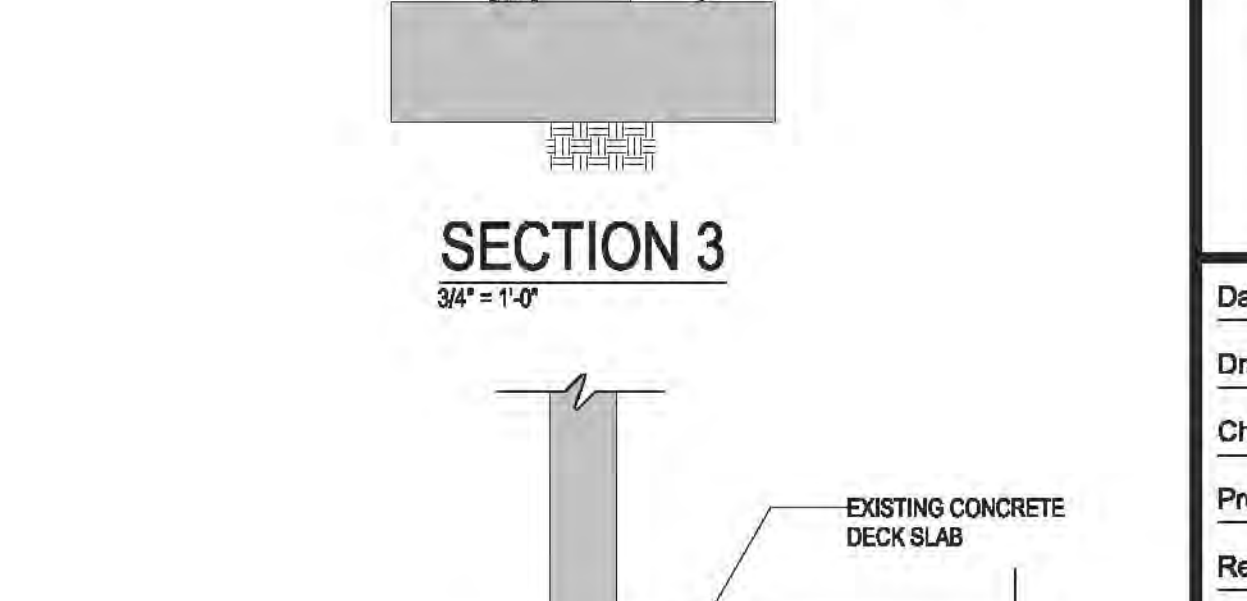

**SECTION 4**  
3/4" = 1'-0"

Special Inspection Required

**Monroe & Newell**  
Engineers, Inc.  
Avon, CO  
70 Benchmark Road, Suite 204  
Avon, Colorado 81620  
(970) 949-7768  
FAX (970) 949-4054  
EMAIL avon@monroe-newell.com  
  
Denver  
1400 Glenasm Place, Suite 101  
Denver, Colorado 80202  
(303) 625-4927  
FAX (303) 623-6602  
EMAIL denver@monroe-newell.com

**SEE FOREVER LODGE RESTAURANT REMODEL**  
TELLURIDE, COLORADO

|             |          |
|-------------|----------|
| Date        | 05/03/17 |
| Drawn By    | CAH      |
| Checked By  | JIN      |
| Project No. | 10509    |
| Revisions   |          |

**GENERAL NOTES AND SECTIONS**  
**S1.1**

5/3/17





**Monroe & Newell**  
Engineers, Inc.

**Avon**  
P.O. Box 1597  
70 Benchmark Road, Suite 204  
Avon, Colorado 81620  
(970) 949-7768  
FAX (970) 949-4054  
EMAIL avon@monroe-newell.com

**Denver**  
1400 Glenasm Place, Suite 101  
Denver, Colorado 80202  
(303) 623-4927  
FAX (303) 623-6602  
EMAIL denver@monroe-newell.com

5/3/17

**SEE FOREVER LODGE  
RESTAURANT  
REMODEL**  
TELLURIDE, COLORADO

Date 04/26/17  
Drawn By CAH  
Checked By JIN  
Project No. 10509

Revisions

**FOUNDATION, GARDEN  
LEVEL, AND LEVEL 1 PLANS**

**S2.1**

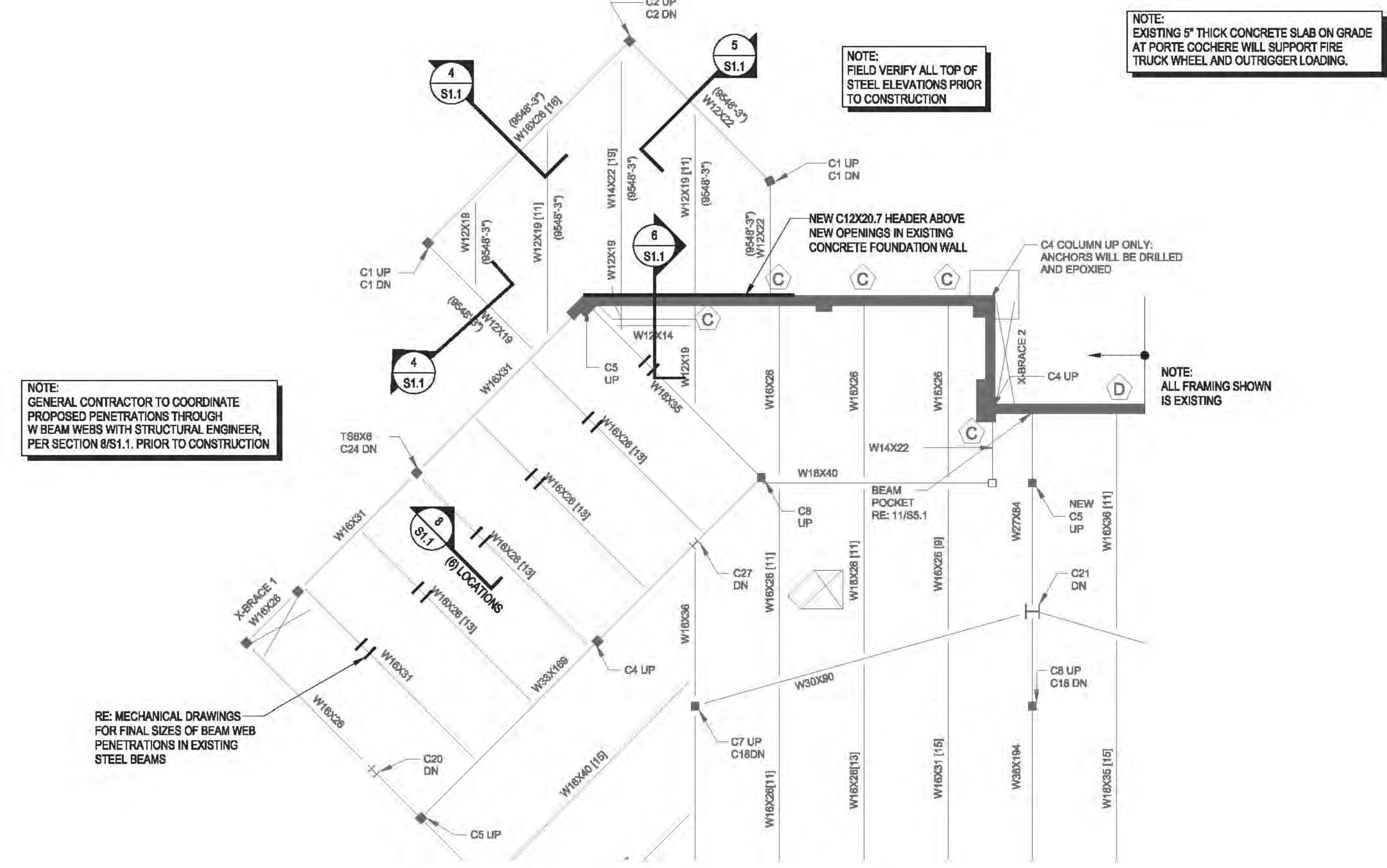

**LEVEL 1 FRAMING PLAN** (ORIGINAL STRUCTURAL DRAWING SA3.4)  
1/8"=1'-0"

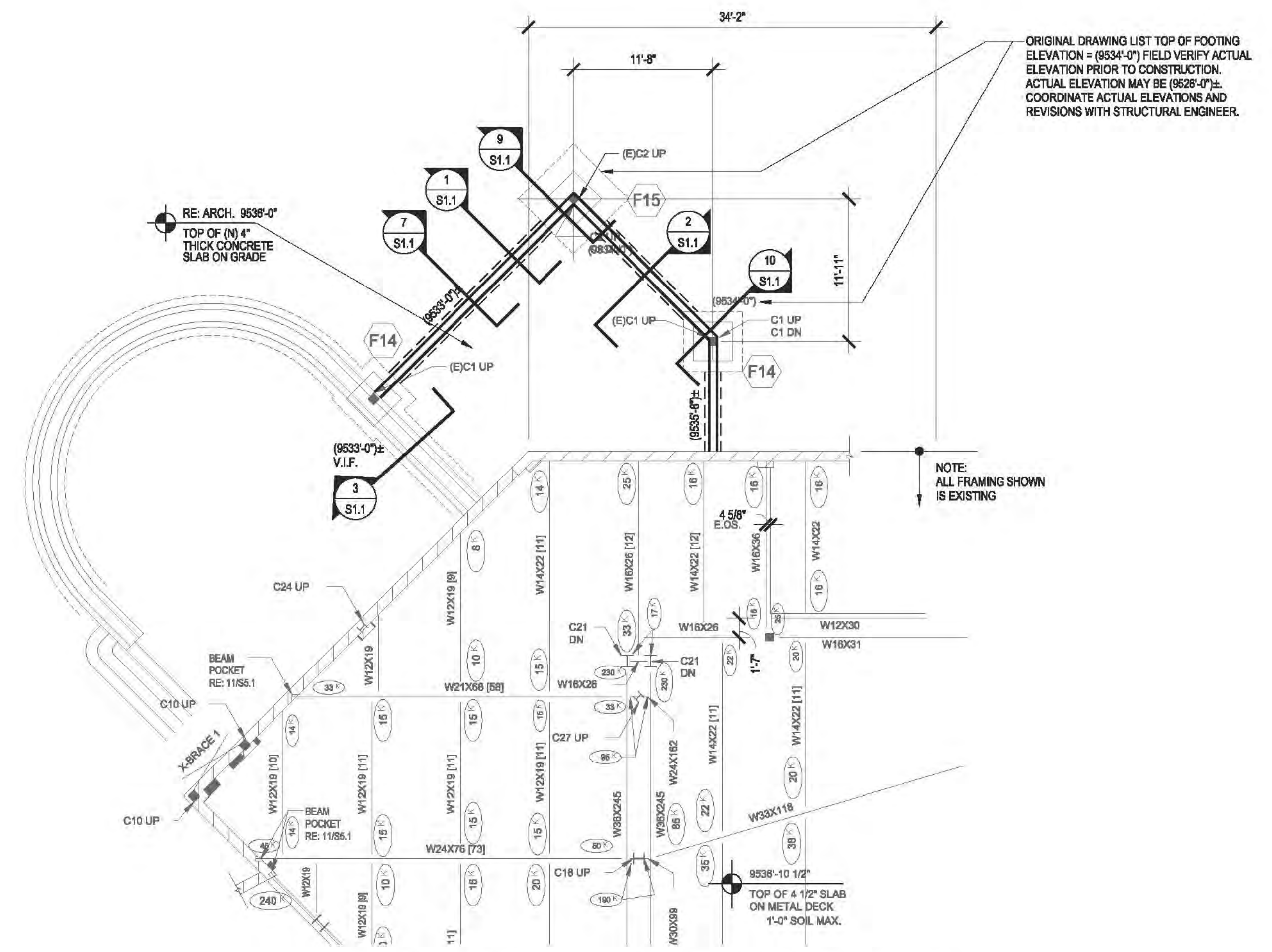

**GARDEN LEVEL FRAMING PLAN** (ORIGINAL STRUCTURAL DRAWING SA3.3)  
1/8"=1'-0"

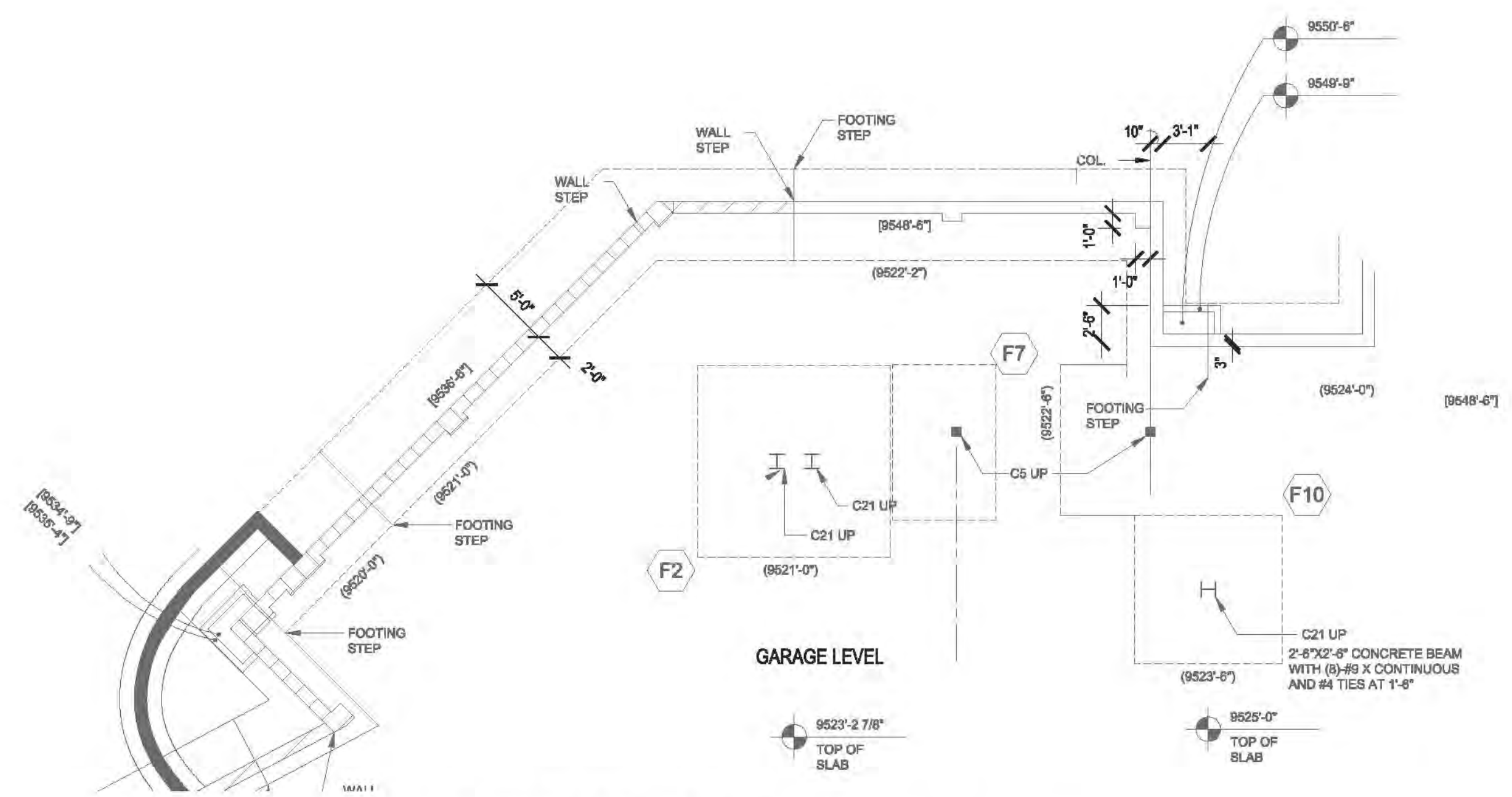

**FOUNDATION PLAN** (ORIGINAL STRUCTURAL DRAWING SA3.2)  
1/8"=1'-0"

NOTE: GENERAL CONTRACTOR TO COORDINATE PROPOSED PENETRATIONS THROUGH W BEAM WEBS WITH STRUCTURAL ENGINEER, PER SECTION 8/S1.1. PRIOR TO CONSTRUCTION

NOTE: FIELD VERIFY ALL TOP OF STEEL ELEVATIONS PRIOR TO CONSTRUCTION

NOTE: EXISTING 5" THICK CONCRETE SLAB ON GRADE AT PORTE COCHERE WILL SUPPORT FIRE TRUCK WHEEL AND OUTRIGGER LOADING.

ORIGINAL DRAWING LIST TOP OF FOOTING ELEVATION = (8534'-0") FIELD VERIFY ACTUAL ELEVATION PRIOR TO CONSTRUCTION. ACTUAL ELEVATION MAY BE (8628'-0")±. COORDINATE ACTUAL ELEVATIONS AND REVISIONS WITH STRUCTURAL ENGINEER.

NOTE: ALL FRAMING SHOWN IS EXISTING

RE: MECHANICAL DRAWINGS FOR FINAL SIZES OF BEAM WEB PENETRATIONS IN EXISTING STEEL BEAMS

NEW C12X20.7 HEADER ABOVE NEW OPENINGS IN EXISTING CONCRETE FOUNDATION WALL

C4 COLUMN UP ONLY: ANCHORS WILL BE DRILLED AND EPOXIED

NOTE: ALL FRAMING SHOWN IS EXISTING

RE: ARCH. 9539'-0" TOP OF (N) 4" THICK CONCRETE SLAB ON GRADE

5539'-10 1/2" TOP OF 4 1/2" SLAB ON METAL DECK 1'-0" SOIL MAX.

9523'-2 7/8" TOP OF SLAB

9523'-0" TOP OF SLAB



① SITE PLAN - GARDEN LEVEL  
1" = 10'-0"

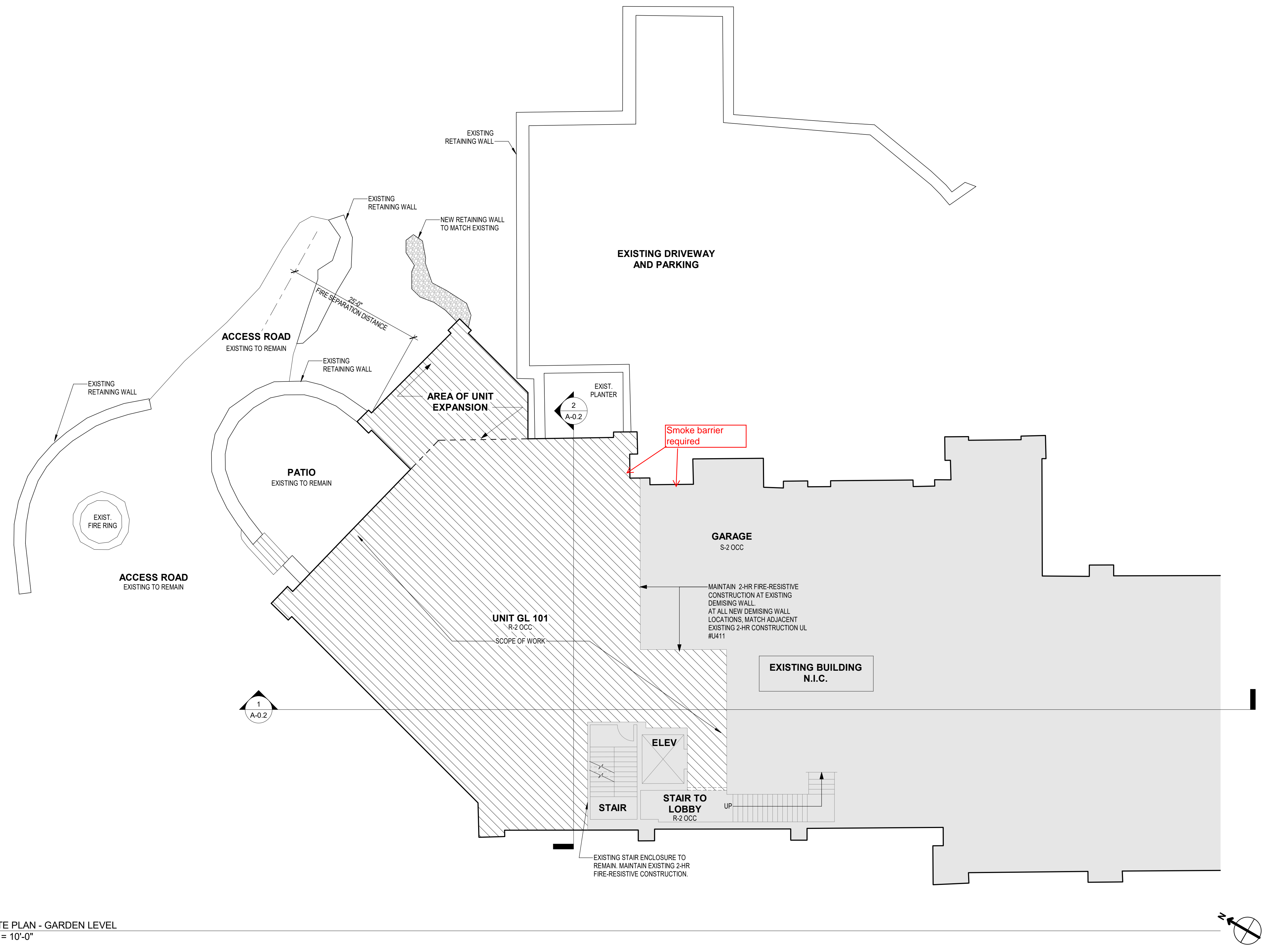

|                                                                        |                                                                                                                               |                                                                                                                          |  |                                                                                                                   |                                                                                                                               |
|------------------------------------------------------------------------|-------------------------------------------------------------------------------------------------------------------------------|--------------------------------------------------------------------------------------------------------------------------|--|-------------------------------------------------------------------------------------------------------------------|-------------------------------------------------------------------------------------------------------------------------------|
| PAGE:<br><b>A-0.1</b><br>DRAWING: PROJECT INFO<br>GENERAL NOTES, INDEX | JOB TITLE:<br><b>INTERIOR MODIFICATIONS</b><br>JOB ADDRESS:<br>SEE FOREVER VILLAGE, UNIT GL 101<br>MOUNTAIN VILLAGE, CO 81435 | ONSHORE CONSTRUCTION AND DEVELOPMENT, INC.<br>938 NORTH OLD DIXIE HIGHWAY<br>JUPITER, FL 33458<br>OFFICE: (561) 744-8331 |  | SKEMATIC DESIGN: 05-13-2017<br>FINAL DESIGN: 05-13-2017<br>PERMIT SUBMITTAL: 05-20-2017<br>ADDENDUM 1: 06-06-2017 | THIS IS AN ORIGINAL DESIGN AND MUST NOT BE RELEASED OR COPIED UNLESS THE ORIGINAL DESIGNER HAS BEEN PAID OR JOB ORDER PLACED. |
|                                                                        |                                                                                                                               |                                                                                                                          |  |                                                                                                                   |                                                                                                                               |

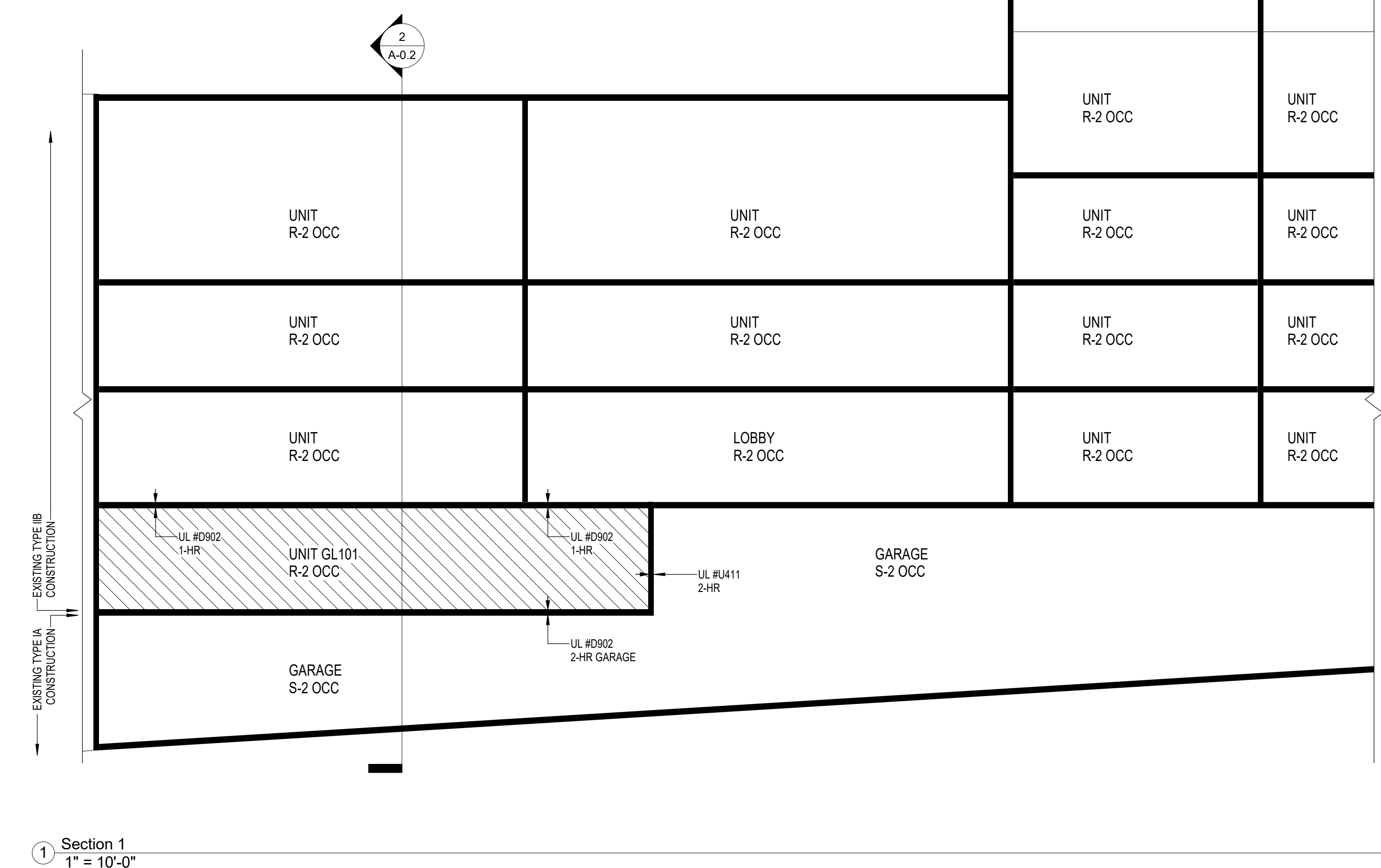
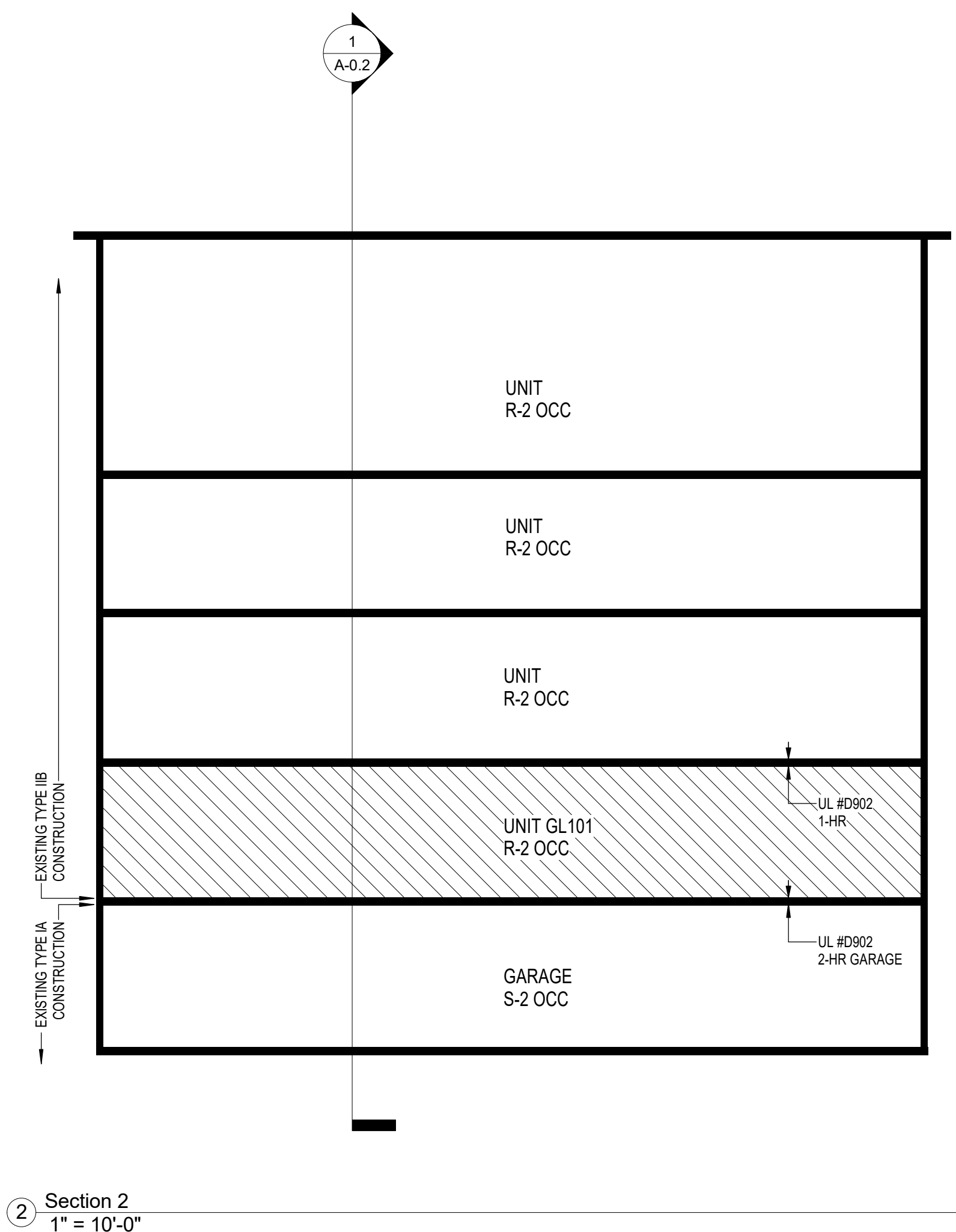
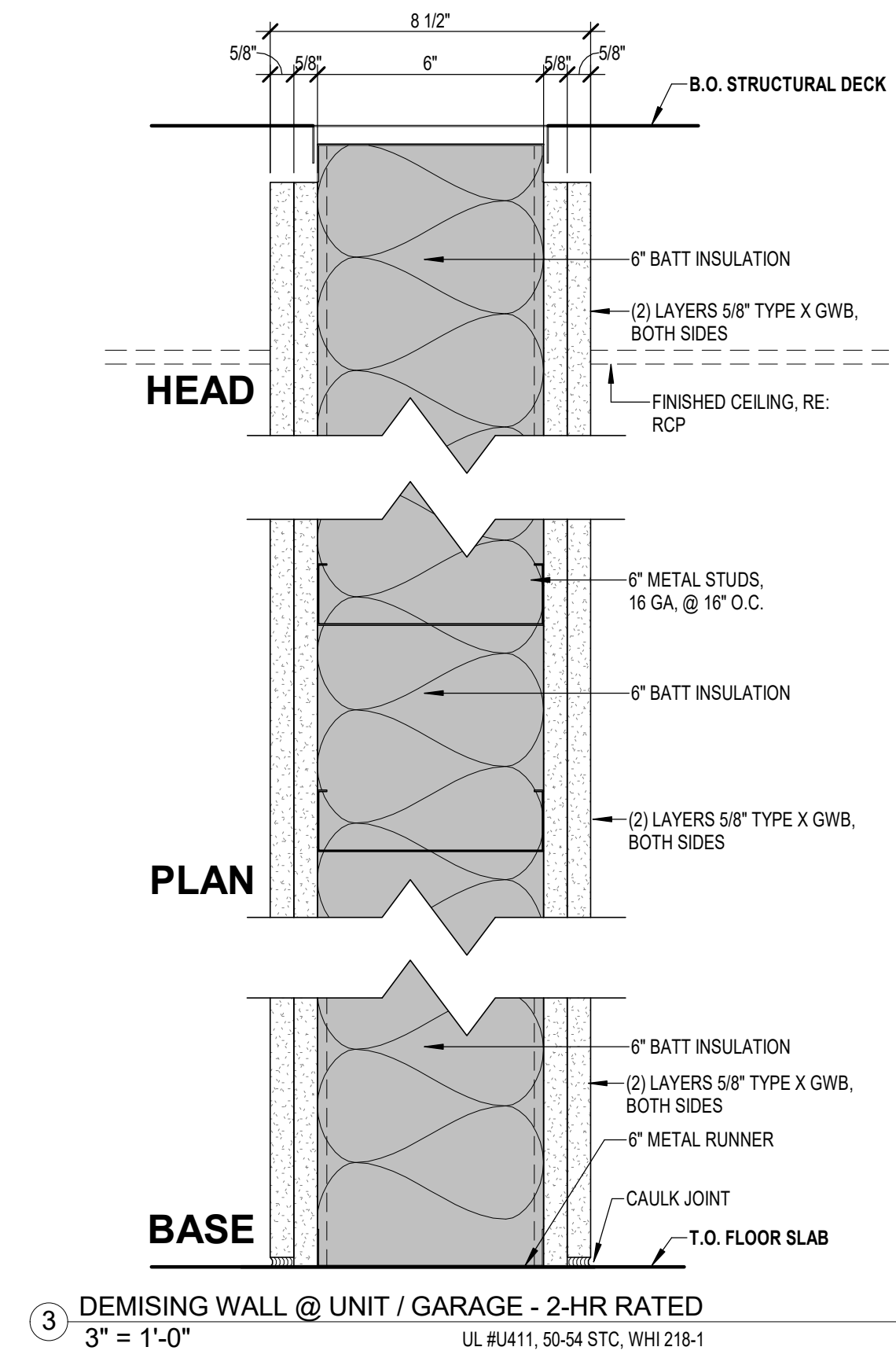
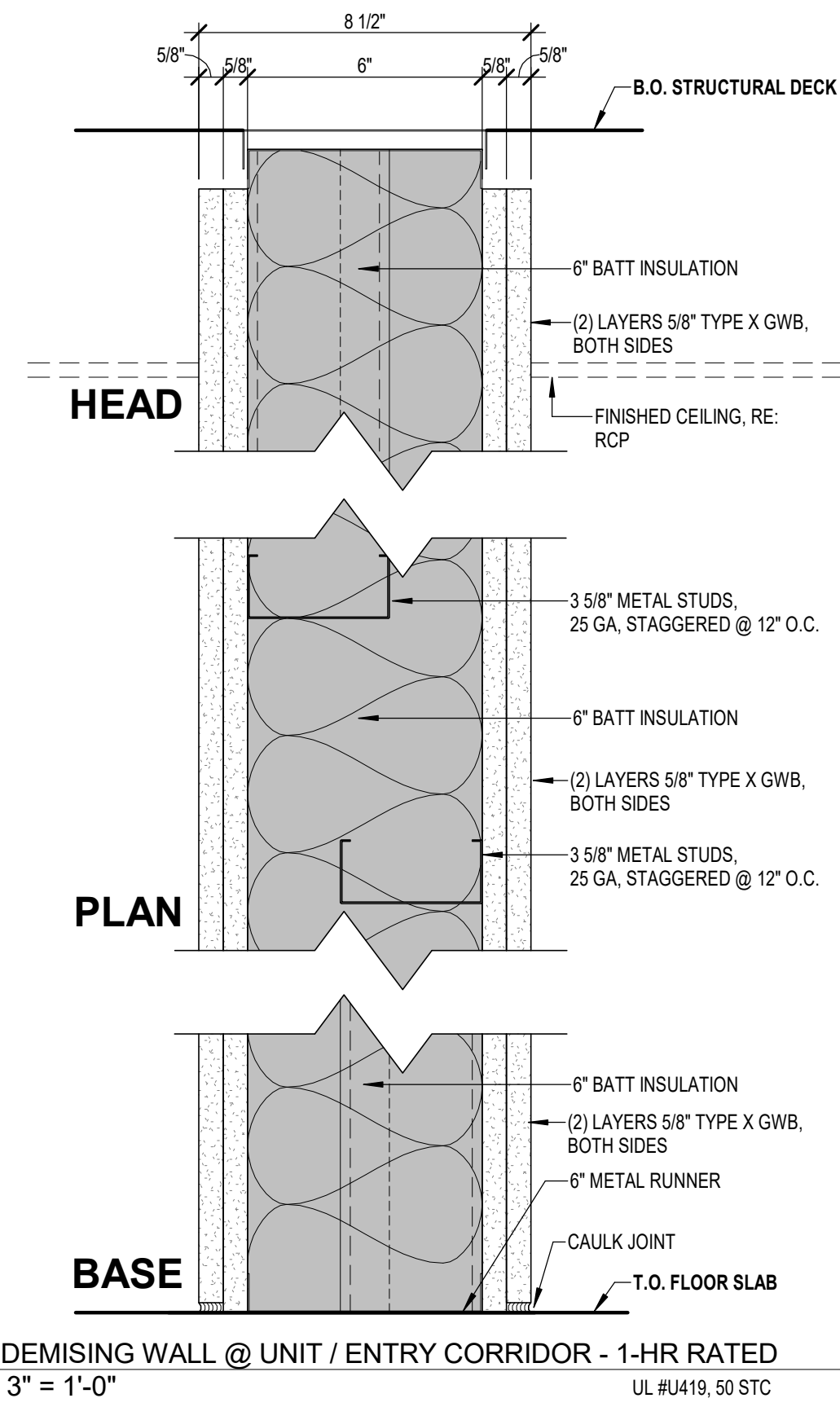
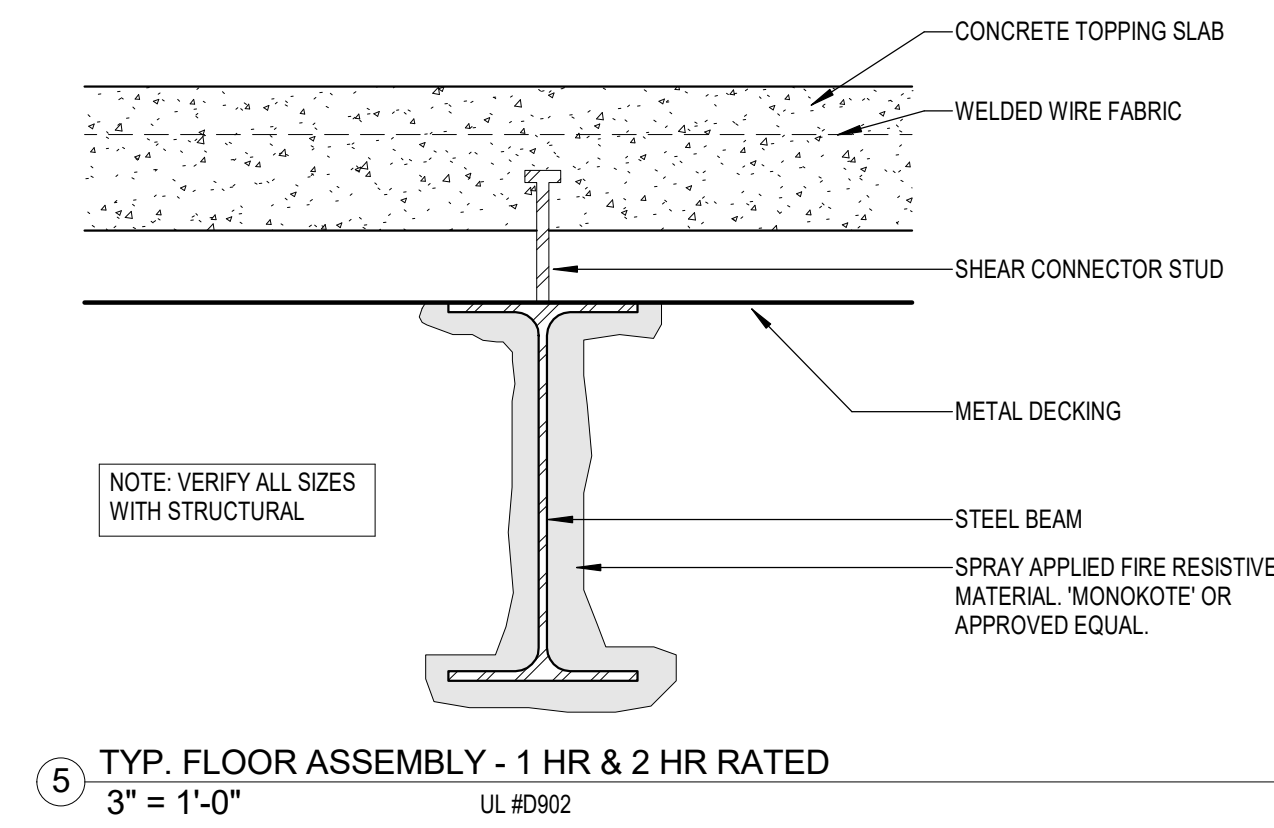
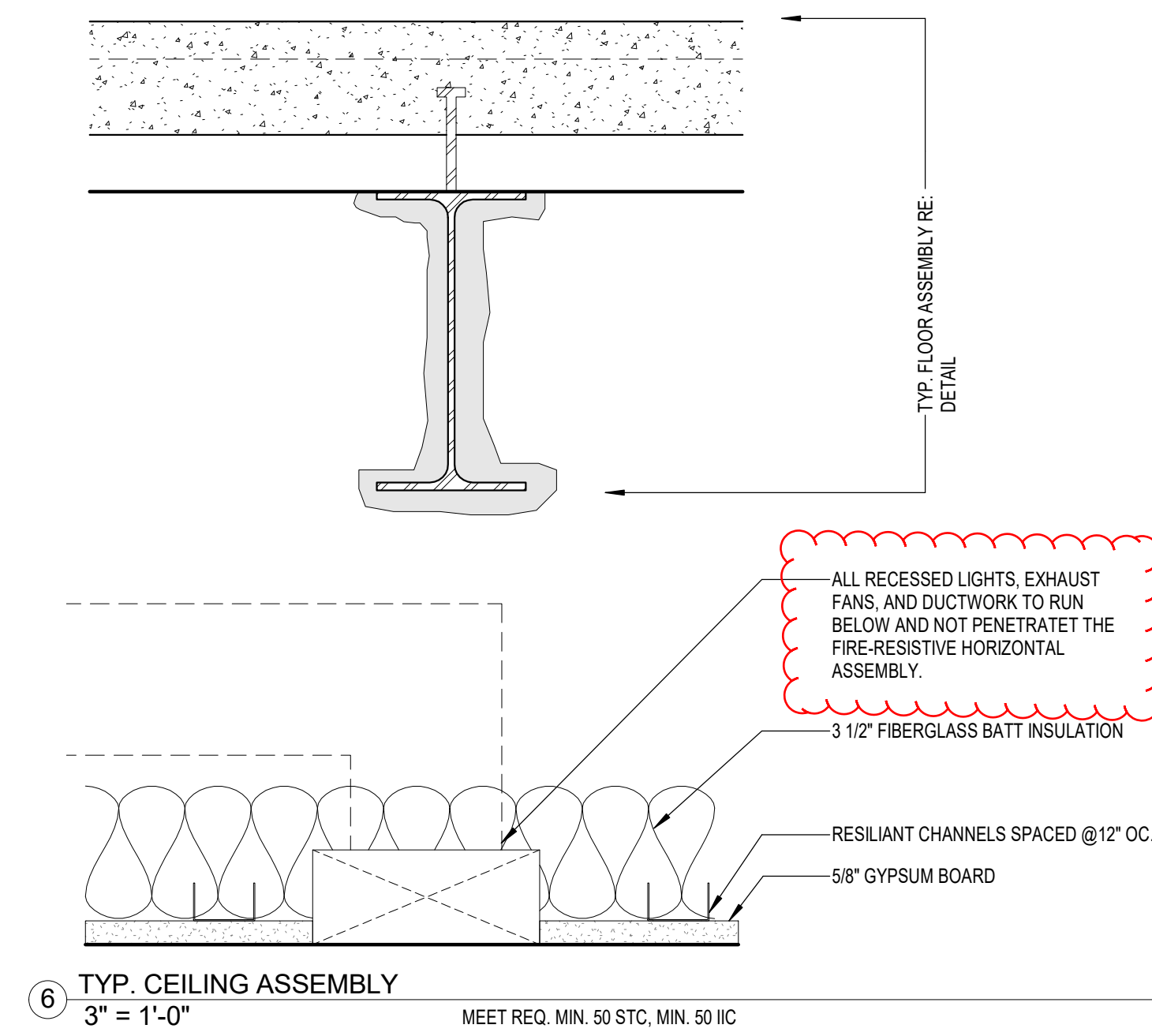

THIS IS AN ORIGINAL DESIGN AND MUST NOT BE RELEASED OR COPIED UNLESS THE ORIGINAL HAS BEEN PAID FOR OR JOB ORDER PLACED.

SKEMATIC DESIGN: 03-13-2017  
FINAL DESIGN: 03-13-2017  
PERMIT SUBMITTAL: 03-20-2017  
ADDENDUM 1: 06-06-2017

STATE OF COLORADO  
LAURA P. HEARS  
003740  
05.05.17  
LICENSED ARCHITECT

ONSHORE CONSTRUCTION AND DEVELOPMENT, INC.  
938 NORTH OLD DIXIE HIGHWAY  
JUPITER, FL 33458  
OFFICE: (561) 744-8331

JOB TITLE: INTERIOR MODIFICATIONS  
JOB ADDRESS: SEE FOREVER VILLAGE, UNIT GL 101, MOUNTAIN VILLAGE, CO 81535

PAGE: A-0.2  
DRAWING: PROJECT INFO, GENERAL NOTES, INDEX



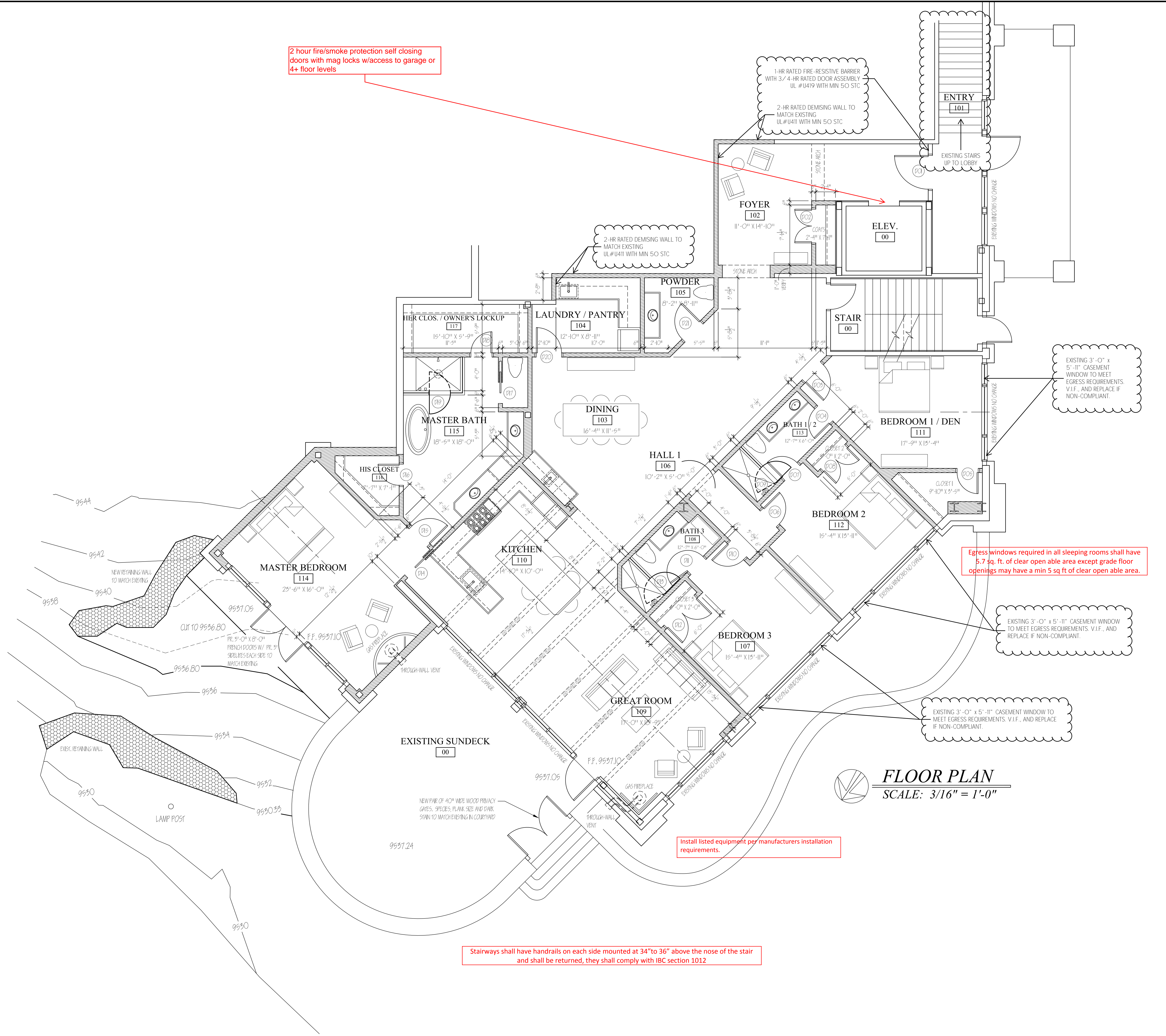

**FLOOR PLAN**  
SCALE: 3/16" = 1'-0"

THIS IS AN ORIGINAL DESIGN AND MUST NOT BE RELEASED OR COPIED UNLESS THE ORIGINAL HAS BEEN PAID FOR OR ORDER PLACED.

SCHEMATIC DESIGN: 05-13-2017  
FINAL DESIGN: 05-13-2017  
PERMIT SUBMITTAL: 03-20-2017  
ADDENDUM 1: 06-06-2017

STATE OF COLORADO  
LAURA P. HEARS  
003740  
05.05.17  
LICENSED ARCHITECT

ONSHORE CONSTRUCTION AND DEVELOPMENT, INC.  
938 NORTH OLD DIXIE HIGHWAY  
JUPITER, FL 33458  
OFFICE: (561) 744-8331

JOB TITLE: INTERIOR MODIFICATIONS  
JOB ADDRESS: SEE FOREVER VILLAGE UNIT G1. 101 MOUNTAIN VILLAGE CO. 8155

PAGE: **A-1**  
DRAWING: FLOOR PLAN





D01 - PHOTO OF EXISTING DOOR -  
MATCH EXISTING UNIT ENTRY DOORS

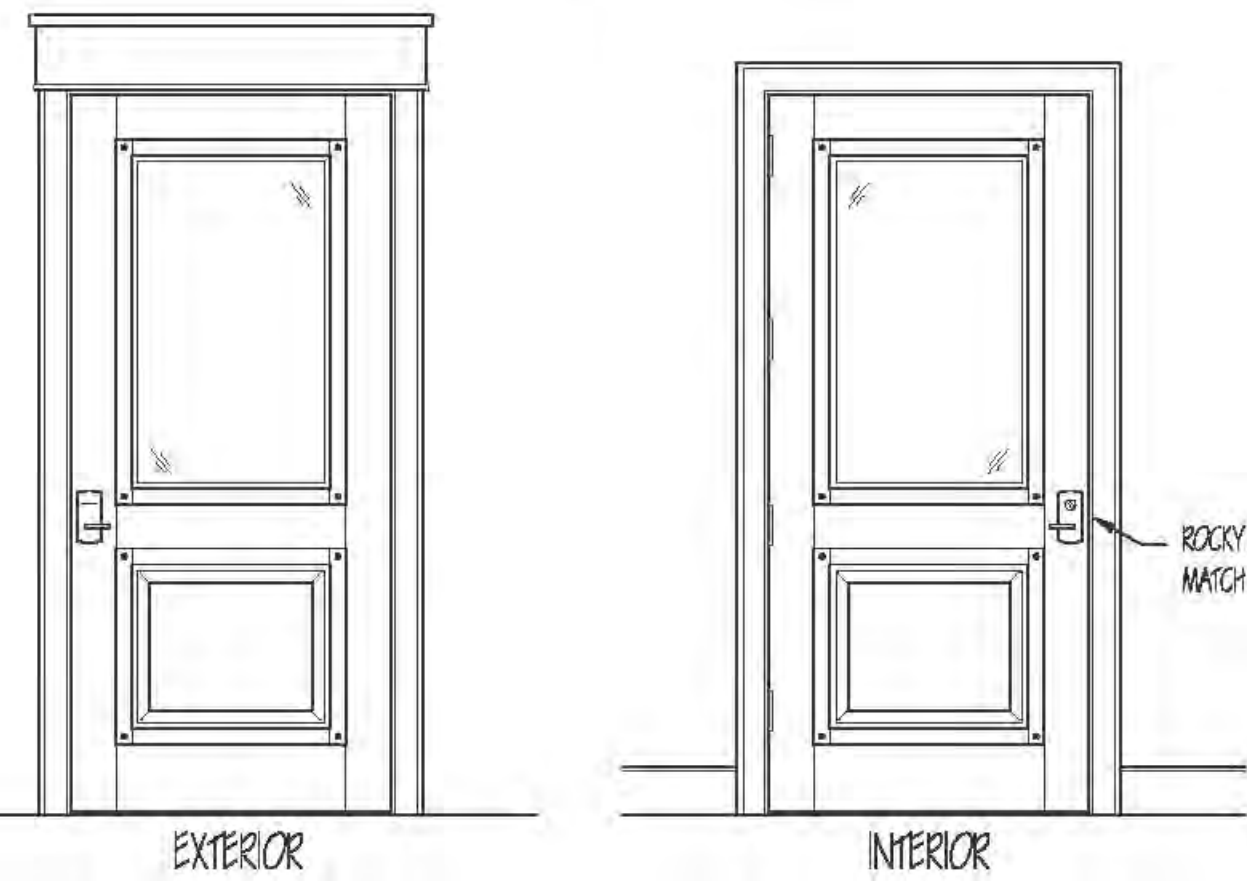

D01 - ENTRY DOOR ELEVATION  
SCALE: 1/2" = 1'-0"

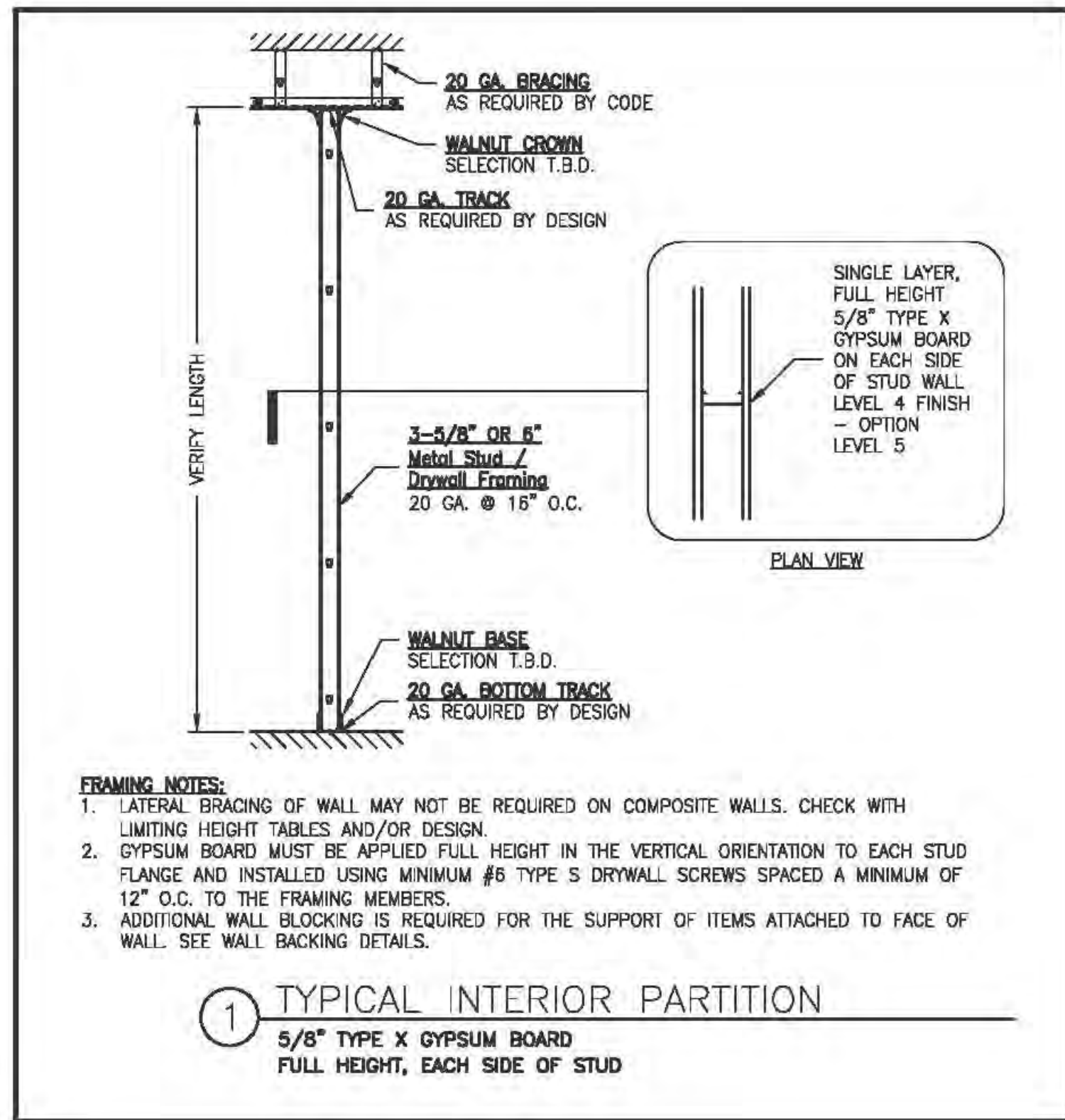

### INTERIOR DOOR SCHEDULE

| DOOR NO. | ROOM NAME     | TYPE              | WIDTH     | HEIGHT | HANDING    | THICKNESS | DOOR MATERIAL | JAMB MATERIAL | THRESH. | HINGES | HANDLE | LOCK          | NOTES            |
|----------|---------------|-------------------|-----------|--------|------------|-----------|---------------|---------------|---------|--------|--------|---------------|------------------|
| D01      | ENTRY / FOYER | WD. / GLASS       | 4'-0"     | 7'-6"  | RH INSWING | 2-1/4"    | MAHOGANY      | MAHOGANY      | USJOB   | USJOB  | -      | E-KEY / THUMB | MATCH EXISTING   |
| D02      | COATS         | S.C. RAISED PANEL | PR. 2'-0" | 7'-6"  | -          | -         | WALNUT        | WALNUT        | -       | USJOB  | LEVER  | DUMMY         | HEAVY BALL CATCH |
| D03      | BED 1 / DEN   | S.C. RAISED PANEL | 3'-0"     | 7'-6"  | RH         | 2-1/4"    | WALNUT        | WALNUT        | -       | USJOB  | LEVER  | PRIVACY       | -                |
| D04      | BATH 1 / 2    | S.C. RAISED PANEL | 2'-6"     | 7'-6"  | LH         | 2-1/4"    | WALNUT        | WALNUT        | -       | USJOB  | LEVER  | PRIVACY       | -                |
| D05      | BED 1 CLOSET  | S.C. RAISED PANEL | 2'-6"     | 7'-6"  | LH         | 2-1/4"    | WALNUT        | WALNUT        | -       | USJOB  | LEVER  | PASSAGE       | -                |
| D06      | BEDROOM 2     | S.C. RAISED PANEL | 2'-8"     | 7'-6"  | LH         | 2-1/4"    | WALNUT        | WALNUT        | -       | USJOB  | LEVER  | PRIVACY       | -                |
| D07      | BATH 1 / 2    | S.C. RAISED PANEL | 2'-6"     | 7'-6"  | LH         | 2-1/4"    | WALNUT        | WALNUT        | -       | USJOB  | LEVER  | PRIVACY       | -                |
| D08      | BED 1 CLOSET  | S.C. RAISED PANEL | PR. 2'-0" | 7'-6"  | -          | -         | WALNUT        | WALNUT        | -       | USJOB  | LEVER  | DUMMY         | HEAVY BALL CATCH |
| D09      | BATH 1 / 2    | FRAMELESS GLASS   | 2'-6"     | VERIFY | -          | 2-1/4"    | TEMP. GLASS   | -             | -       | USJOB  | STD    | -             | FIELD MEASURE    |
| D10      | BEDROOM 3     | S.C. RAISED PANEL | 2'-8"     | 7'-6"  | RH         | 2-1/4"    | WALNUT        | WALNUT        | -       | USJOB  | LEVER  | PRIVACY       | -                |
| D11      | BATH 3        | S.C. RAISED PANEL | 2'-6"     | 7'-6"  | LH         | 2-1/4"    | WALNUT        | WALNUT        | -       | USJOB  | LEVER  | PRIVACY       | -                |
| D12      | BED 3 CLOSET  | S.C. RAISED PANEL | PR. 2'-6" | 7'-6"  | -          | 2-1/4"    | WALNUT        | WALNUT        | -       | USJOB  | LEVER  | DUMMY         | HEAVY BALL CATCH |
| D13      | BATH 3        | FRAMELESS GLASS   | 2'-6"     | VERIFY | -          | -         | TEMP. GLASS   | -             | -       | USJOB  | STD    | -             | FIELD MEASURE    |
| D14      | MASTER BED    | S.C. RAISED PANEL | 3'-0"     | 7'-6"  | POCKET     | 2-1/4"    | WALNUT        | WALNUT        | -       | USJOB  | POCKET | PRIVACY       | 6" POCKET FRAME  |
| D15      | MASTER BATH   | S.C. RAISED PANEL | 3'-0"     | 7'-6"  | RH         | 2-1/4"    | WALNUT        | WALNUT        | -       | USJOB  | LEVER  | PRIVACY       | -                |
| D16      | HIS CLOSET    | S.C. RAISED PANEL | 2'-6"     | 7'-6"  | RH         | 2-1/4"    | WALNUT        | WALNUT        | -       | USJOB  | LEVER  | PASSAGE       | -                |
| D17      | MASTER TOILET | S.C. RAISED PANEL | 2'-6"     | 7'-6"  | POCKET     | 2-1/4"    | WALNUT        | WALNUT        | -       | USJOB  | POCKET | PRIVACY       | -                |
| D18      | MRS / LOCKUP  | S.C. RAISED PANEL | 2'-6"     | 7'-6"  | RH         | 2-1/4"    | WALNUT        | WALNUT        | -       | USJOB  | LEVER  | KEY           | -                |
| D19      | MASTER BATH   | FRAMELESS GLASS   | 2'-6"     | VERIFY | -          | -         | TEMP. GLASS   | -             | -       | USJOB  | STD    | -             | FIELD MEASURE    |
| D20      | LAUNDRY       | S.C. RAISED PANEL | 3'-0"     | 7'-6"  | LH         | 2-1/4"    | WALNUT        | WALNUT        | -       | USJOB  | LEVER  | PASSAGE       | -                |
| D21      | POWDER        | S.C. RAISED PANEL | 3'-0"     | 7'-6"  | RH         | 2-1/4"    | WALNUT        | WALNUT        | -       | USJOB  | LEVER  | PRIVACY       | -                |

### ROOM MATERIAL SCHEDULE

| ROOM NO. | ROOM NAME        | FLOORING      | FLOOR AREA      | WALLS    | CEILING             | BASE | JAMBS  | SKIRT | CASING | CHAIR RAIL | APPLIED | CROWN | BEAMS  | NOTES                                            |
|----------|------------------|---------------|-----------------|----------|---------------------|------|--------|-------|--------|------------|---------|-------|--------|--------------------------------------------------|
| 101      | ENTRY            | EX. FLAGSTONE | - SQ. FT.       | EXISTING | EXISTING            | -    | -      | -     | -      | -          | -       | -     | -      | -                                                |
| 102      | FOYER            | FLAGSTONE     | 279 SQ. FT.     | STONE    | DRYWALL             | -    | WALNUT | -     | WALNUT | -          | -       | -     | STONE  | -                                                |
| 103      | DINING           | WOOD          | 1480 SQ. FT.    | DRYWALL  | DRYWALL             | WOOD | WOOD   | -     | WOOD   | -          | -       | -     | -      | FLOOR INCLUDES POWDER, HALL 1, GREAT ROOM, KIT.  |
| 104      | LAUNDRY          | STONE         | 106 SQ. FT.     | DRYWALL  | DRYWALL             | WOOD | WOOD   | -     | WOOD   | -          | -       | -     | -      | -                                                |
| 105      | POWDER           | WOOD          | incl. in DINING | DRYWALL  | DRYWALL             | WOOD | WOOD   | -     | WOOD   | -          | -       | -     | -      | -                                                |
| 106      | HALL 1           | WOOD          | incl. in DINING | DRYWALL  | DRYWALL             | WOOD | WOOD   | -     | WOOD   | -          | -       | -     | -      | -                                                |
| 107      | BEDROOM 3        | CARPET        | 242 SQ. FT.     | DRYWALL  | DRYWALL             | WOOD | WOOD   | WOOD  | WOOD   | -          | -       | -     | -      | -                                                |
| 108      | BATH 3           | STONE         | *52 SQ. FT.     | DRYWALL  | DRYWALL             | WOOD | WOOD   | -     | WOOD   | -          | -       | -     | -      | *ADD 17 SQ. FT. SHWR FL. & 99 SQ. FT. WALL TILE  |
| 109      | GREAT ROOM       | WOOD          | incl. in DINING | DRYWALL  | DRYWALL / WD. BEAMS | WOOD | WOOD   | WOOD  | WOOD   | -          | -       | -     | WALNUT | -                                                |
| 110      | KITCHEN          | WOOD          | incl. in DINING | DRYWALL  | DRYWALL / WD. BEAMS | WOOD | WOOD   | -     | WOOD   | -          | -       | -     | WALNUT | -                                                |
| 111      | BEDROOM 1 / DEN  | CARPET        | 280 SQ. FT.     | DRYWALL  | DRYWALL             | WOOD | WOOD   | WOOD  | WOOD   | -          | -       | -     | -      | INCLUDES CLOSET                                  |
| 112      | BEDROOM 2        | CARPET        | 242 SQ. FT.     | DRYWALL  | DRYWALL             | WOOD | WOOD   | WOOD  | WOOD   | -          | -       | -     | -      | INCLUDES CLOSET                                  |
| 113      | BATH 1 / 2       | STONE         | *96 SQ. FT.     | DRYWALL  | DRYWALL             | WOOD | WOOD   | -     | WOOD   | -          | -       | -     | -      | *ADD 13 SQ. FT. SHWR FL. & 108 SQ. FT. WALL TILE |
| 114      | MASTER BEDROOM   | WOOD          | 366 SQ. FT.     | DRYWALL  | DRYWALL             | WOOD | WOOD   | -     | WOOD   | -          | -       | -     | -      | -                                                |
| 115      | MASTER BATH      | STONE         | *227 SQ. FT.    | DRYWALL  | DRYWALL             | WOOD | WOOD   | -     | WOOD   | -          | -       | -     | -      | *ADD 27 SQ. FT. SHWR FL. & 108 SQ. FT. WALL TILE |
| 116      | HIS CLOSET       | CARPET        | 42 SQ. FT.      | DRYWALL  | DRYWALL             | WOOD | WOOD   | -     | WOOD   | -          | -       | -     | -      | -                                                |
| 117      | MRS CLOS./LOCKUP | CARPET        | 85 SQ. FT.      | DRYWALL  | DRYWALL             | WOOD | WOOD   | -     | WOOD   | -          | -       | -     | -      | -                                                |

\*DOES NOT INCLUDE CUTS OR WASTE

### ROOM PAINT / STAIN SCHEDULE

| ROOM NO. | ROOM NAME        | FLOORING | WALLS | CEILING | BASE | JAMBS | SKIRT | CASING | CHAIR RAIL | APPLIED | CROWN | BEAMS | NOTES |
|----------|------------------|----------|-------|---------|------|-------|-------|--------|------------|---------|-------|-------|-------|
| 101      | ENTRY            | -        | -     | -       | -    | -     | -     | -      | -          | -       | -     | -     | -     |
| 102      | FOYER            | -        | -     | -       | -    | -     | -     | -      | -          | -       | -     | -     | -     |
| 103      | DINING           | -        | -     | -       | -    | -     | -     | -      | -          | -       | -     | -     | -     |
| 104      | LAUNDRY          | -        | -     | -       | -    | -     | -     | -      | -          | -       | -     | -     | -     |
| 105      | POWDER           | -        | -     | -       | -    | -     | -     | -      | -          | -       | -     | -     | -     |
| 106      | HALL 1           | -        | -     | -       | -    | -     | -     | -      | -          | -       | -     | -     | -     |
| 107      | BEDROOM 3        | -        | -     | -       | -    | -     | -     | -      | -          | -       | -     | -     | -     |
| 108      | BATH 3           | -        | -     | -       | -    | -     | -     | -      | -          | -       | -     | -     | -     |
| 109      | GREAT ROOM       | -        | -     | -       | -    | -     | -     | -      | -          | -       | -     | -     | -     |
| 110      | KITCHEN          | -        | -     | -       | -    | -     | -     | -      | -          | -       | -     | -     | -     |
| 111      | BEDROOM 1 / DEN  | -        | -     | -       | -    | -     | -     | -      | -          | -       | -     | -     | -     |
| 112      | BEDROOM 2        | -        | -     | -       | -    | -     | -     | -      | -          | -       | -     | -     | -     |
| 113      | BATH 1 / 2       | -        | -     | -       | -    | -     | -     | -      | -          | -       | -     | -     | -     |
| 114      | MASTER BEDROOM   | -        | -     | -       | -    | -     | -     | -      | -          | -       | -     | -     | -     |
| 115      | MASTER BATH      | -        | -     | -       | -    | -     | -     | -      | -          | -       | -     | -     | -     |
| 116      | HIS CLOSET       | -        | -     | -       | -    | -     | -     | -      | -          | -       | -     | -     | -     |
| 117      | MRS CLOS./LOCKUP | -        | -     | -       | -    | -     | -     | -      | -          | -       | -     | -     | -     |

STATE OF COLORADO

LAURA P. HEARS  
003740  
03.28.17  
LICENSED ARCHITECT

ONSHORE CONSTRUCTION AND DEVELOPMENT, INC.  
938 NORTH OLD DIXIE HIGHWAY  
JUPITER, FL 33458  
OFFICE: (561) 744-8331

JOB TITLE:  
**INTERIOR MODIFICATIONS**

JOB ADDRESS:  
SEE FOREVER VILLAGE, UNIT G1, 101  
MOUNTAIN VILLAGE, CO 81535

PAGE:  
**A-2**

DRAWING:  
**SCHEDULES**

THIS IS AN ORIGINAL DESIGN AND MUST NOT BE REPRODUCED OR COPIED WITHOUT THE WRITTEN PERMISSION OF THE ARCHITECT. ORDER PLACED: 02-02-2017  
SCHEMATIC DESIGN: 02-02-2017  
FINAL DESIGN: 03-13-2017  
PERMIT SUBMITTAL: 05-20-2017



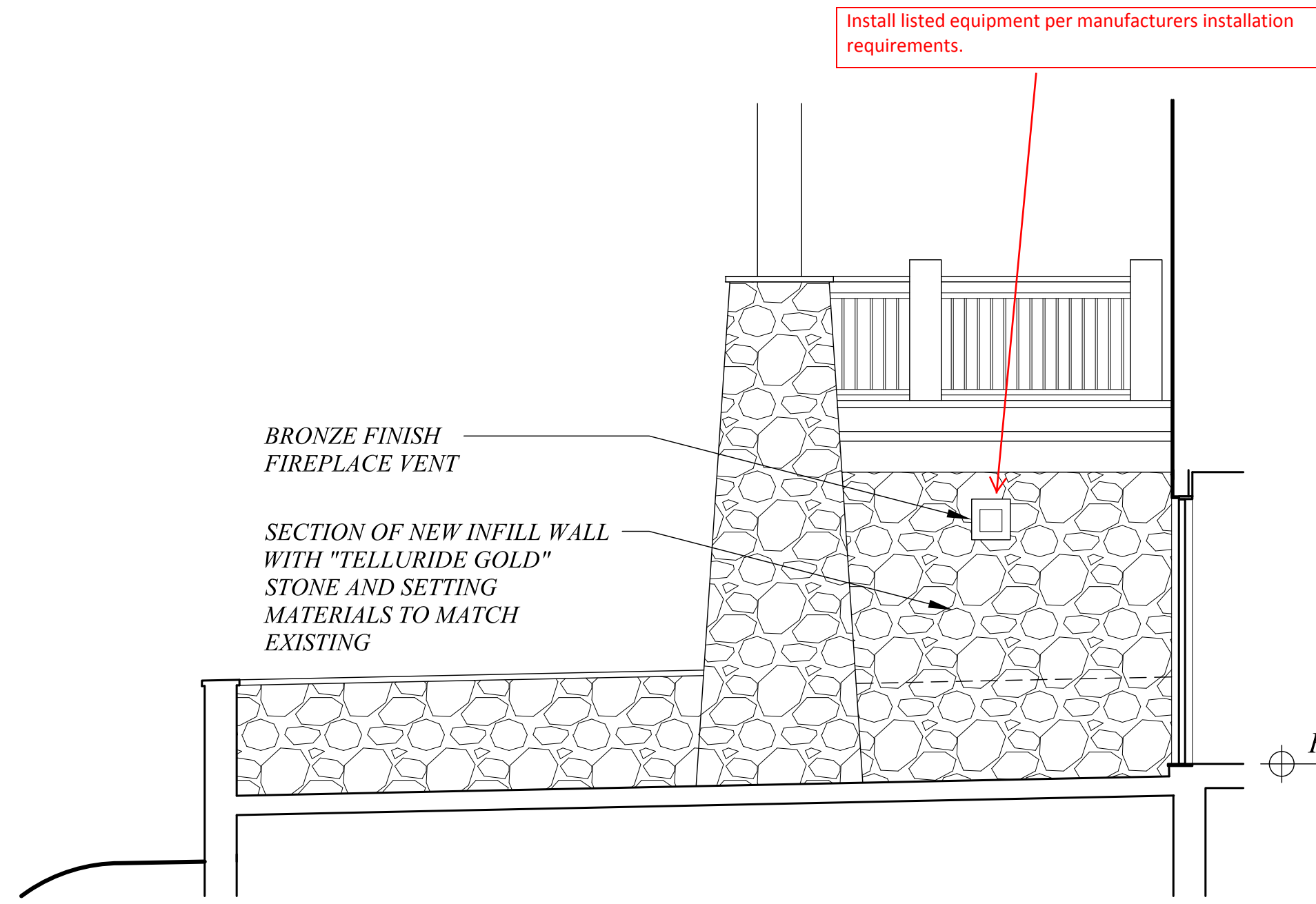

**WEST (RIGHT) ELEVATION @  
INFILL STONE WALL -  
EXISTING OUTDOOR DECK**  
SCALE: 1/4" = 1'-0"



**NORTH ELEVATION @ MASTER  
BEDROOM ADDITION**  
SCALE: 1/4" = 1'-0"

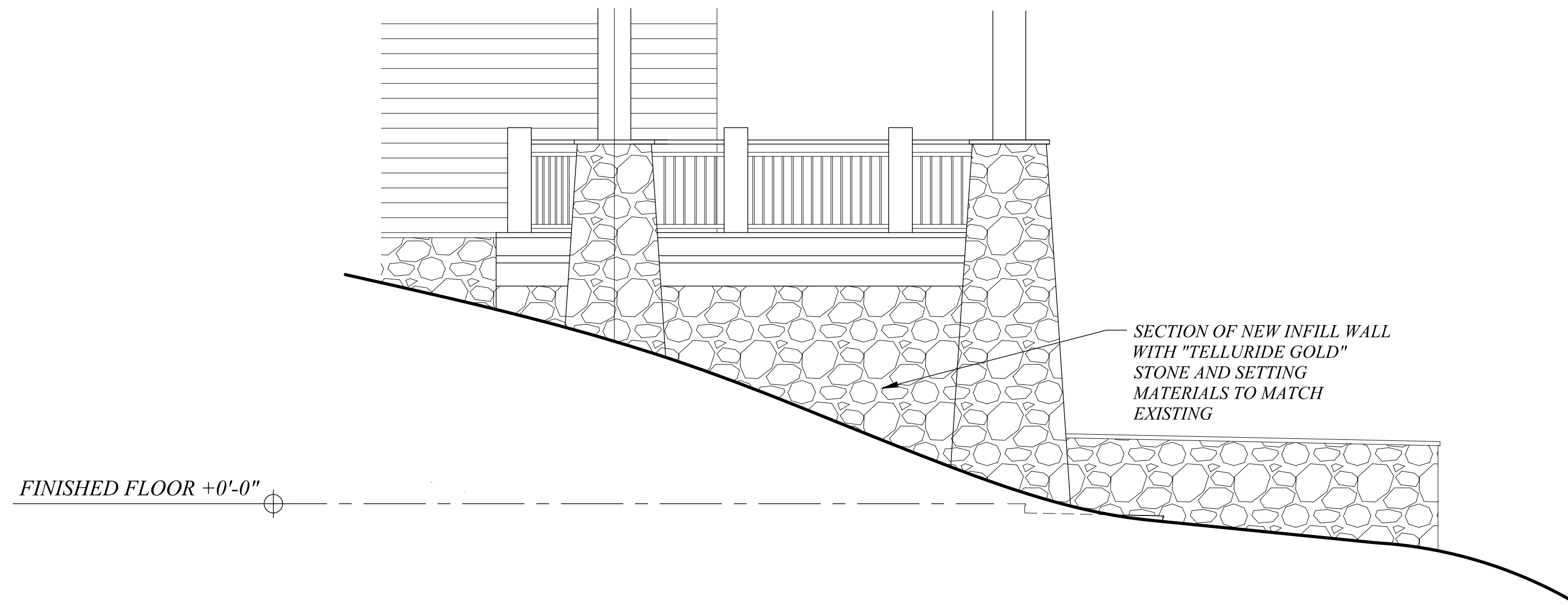

**EAST (LEFT) ELEVATION @  
INFILL STONE WALL -  
EXISTING OUTDOOR DECK**  
SCALE: 1/4" = 1'-0"

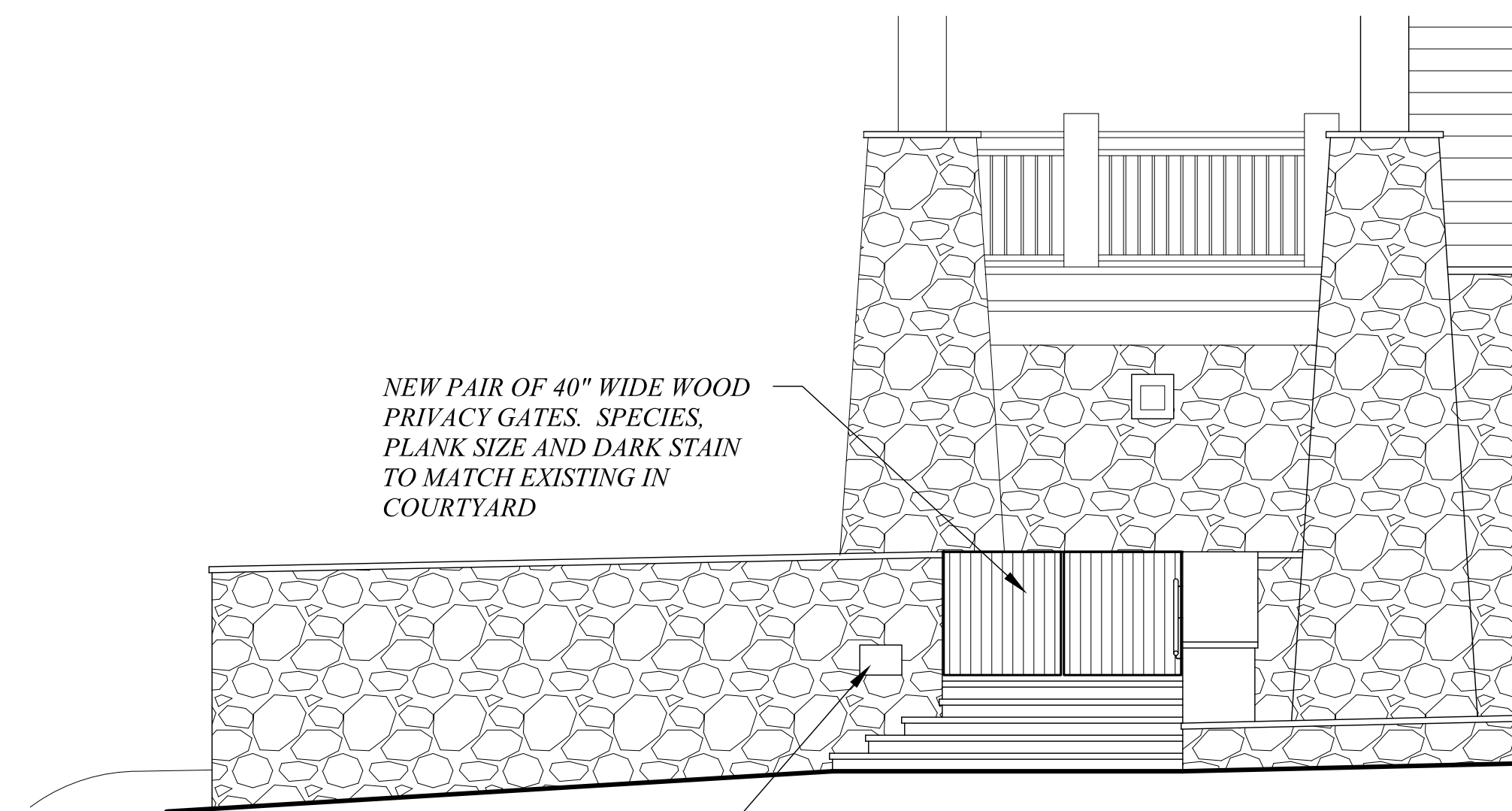

**WEST (RIGHT) - GATE ELEVATION  
AT EXISTING OUTDOOR DECK**  
SCALE: 1/4" = 1'-0"

THIS IS AN ORIGINAL DESIGN AND MUST NOT BE RELEASED OR COPIED UNLESS THE ORIGINAL HAS BEEN PAID FOR OR ORDER PLACED.

SCHEMATIC DESIGN: 03-13-2017  
FINAL DESIGN: 03-13-2017  
PERMIT SUBMITTAL: 03-20-2017

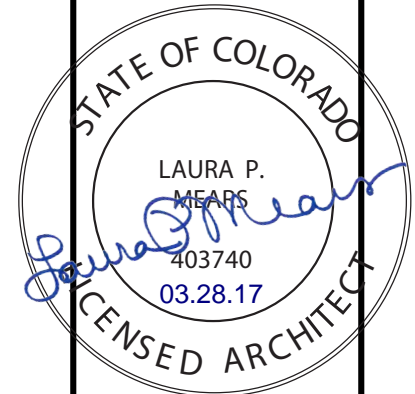

**ONSHORE CONSTRUCTION AND DEVELOPMENT, INC.**  
938 NORTH OLD DIXIE HIGHWAY  
JUPITER, FL 33458  
OFFICE: (561) 744-8331

JOB TITLE:  
**INTERIOR MODIFICATIONS**  
JOB ADDRESS:  
SEE FOREVER VILLAGE, UNIT G1, 101  
MOUNTAIN VILLAGE, CO 81435

PAGE:  
**A-3**  
DRAWING:  
ELEVATIONS

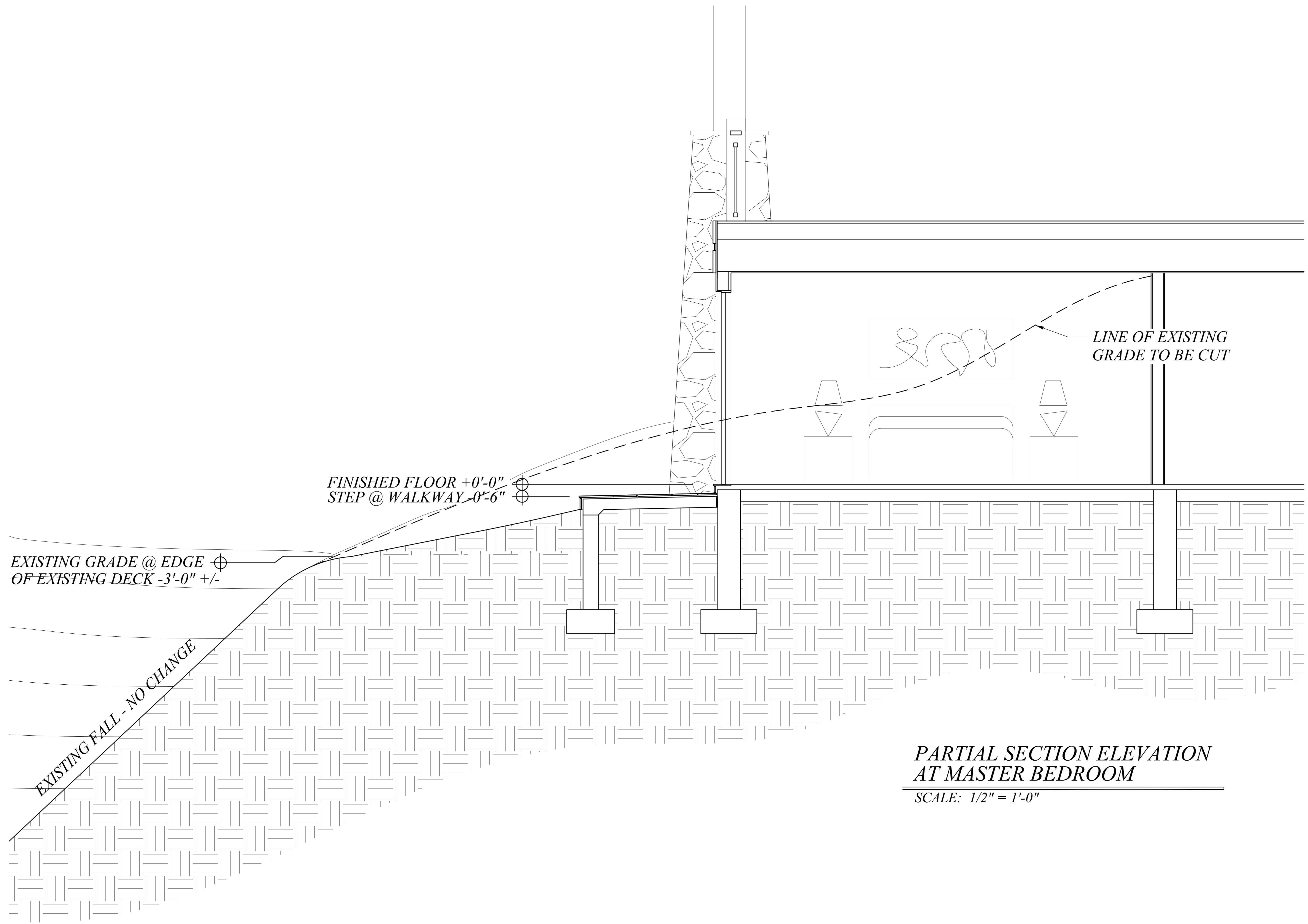

**PARTIAL SECTION ELEVATION  
AT MASTER BEDROOM**  
SCALE: 1/2" = 1'-0"

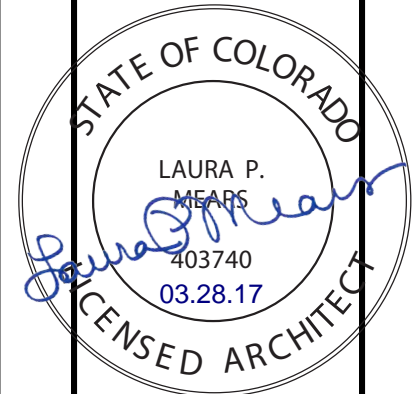

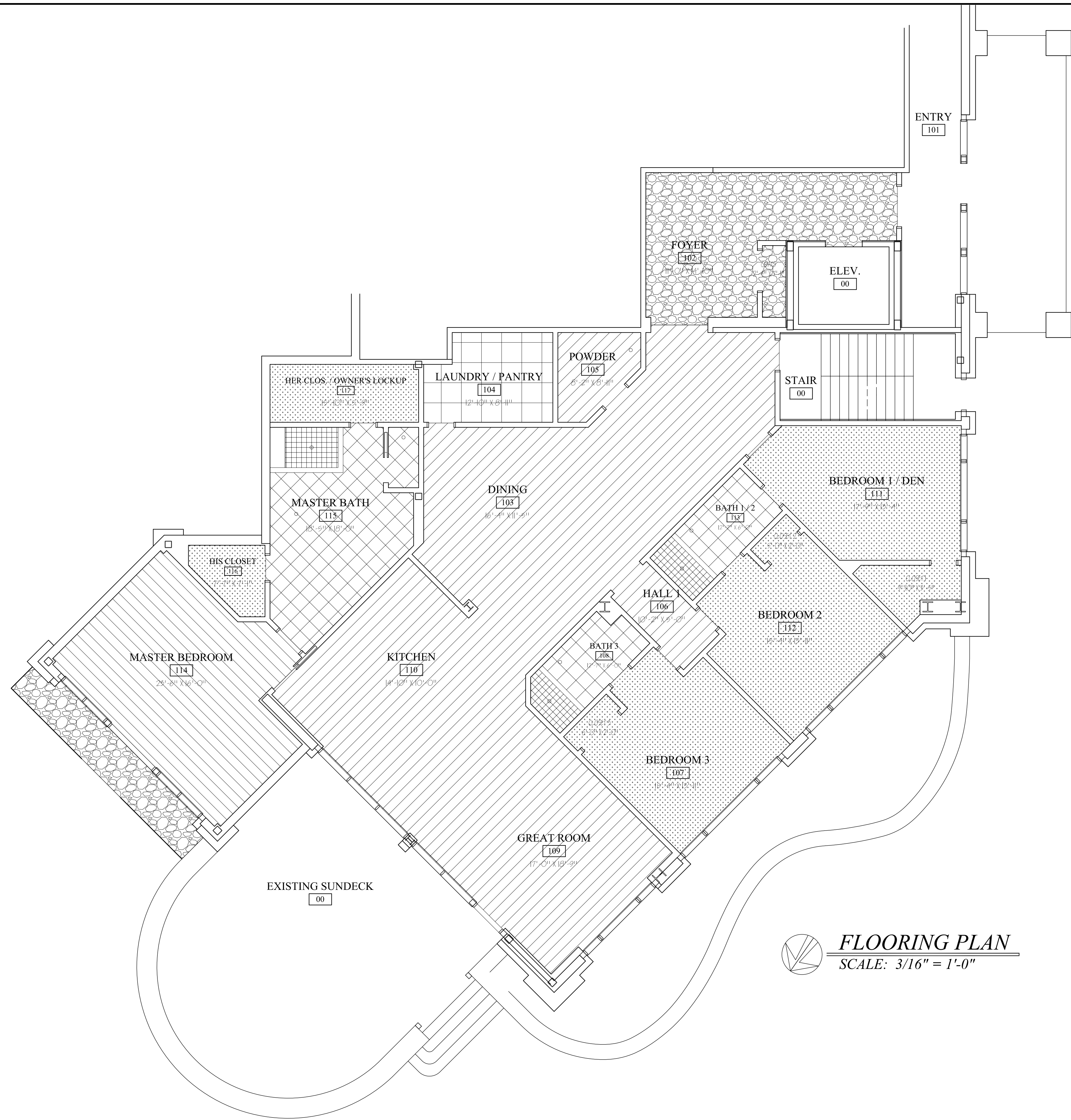

 **FLOORING PLAN**  
SCALE: 3/16" = 1'-0"

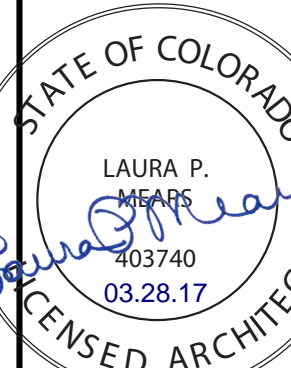
|                                                  |                                                                             |                                                                             |                                                                                                                          |                                                                                     |                                                                                         |                                                                                                                      |
|--------------------------------------------------|-----------------------------------------------------------------------------|-----------------------------------------------------------------------------|--------------------------------------------------------------------------------------------------------------------------|-------------------------------------------------------------------------------------|-----------------------------------------------------------------------------------------|----------------------------------------------------------------------------------------------------------------------|
| PAGE:<br><b>A-5</b><br>DRAWING:<br>FLOORING PLAN | JOB TITLE:<br><b>INTERIOR MODIFICATIONS</b>                                 | JOB ADDRESS:<br>SEE FOREVER VILLAGE, UNIT CL 01<br>MOUNTAIN VILLAGE CO 8145 | ONSHORE CONSTRUCTION AND DEVELOPMENT, INC.<br>938 NORTH OLD DIXIE HIGHWAY<br>JUPITER, FL 33458<br>OFFICE: (561) 744-8331 |  | SKEMATIC DESIGN: 02-02-2017<br>FINAL DESIGN: 03-16-2017<br>PERMIT SUBMITTAL: 03-20-2017 | THIS IS AN ORIGINAL DESIGN AND MUST NOT BE RELEASED OR COPIED UNLESS THE ORIGINAL HAS BEEN PAID OR JOB ORDER PLACED. |
|                                                  | JOB ADDRESS:<br>SEE FOREVER VILLAGE, UNIT CL 01<br>MOUNTAIN VILLAGE CO 8145 |                                                                             |                                                                                                                          |                                                                                     |                                                                                         |                                                                                                                      |



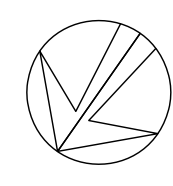
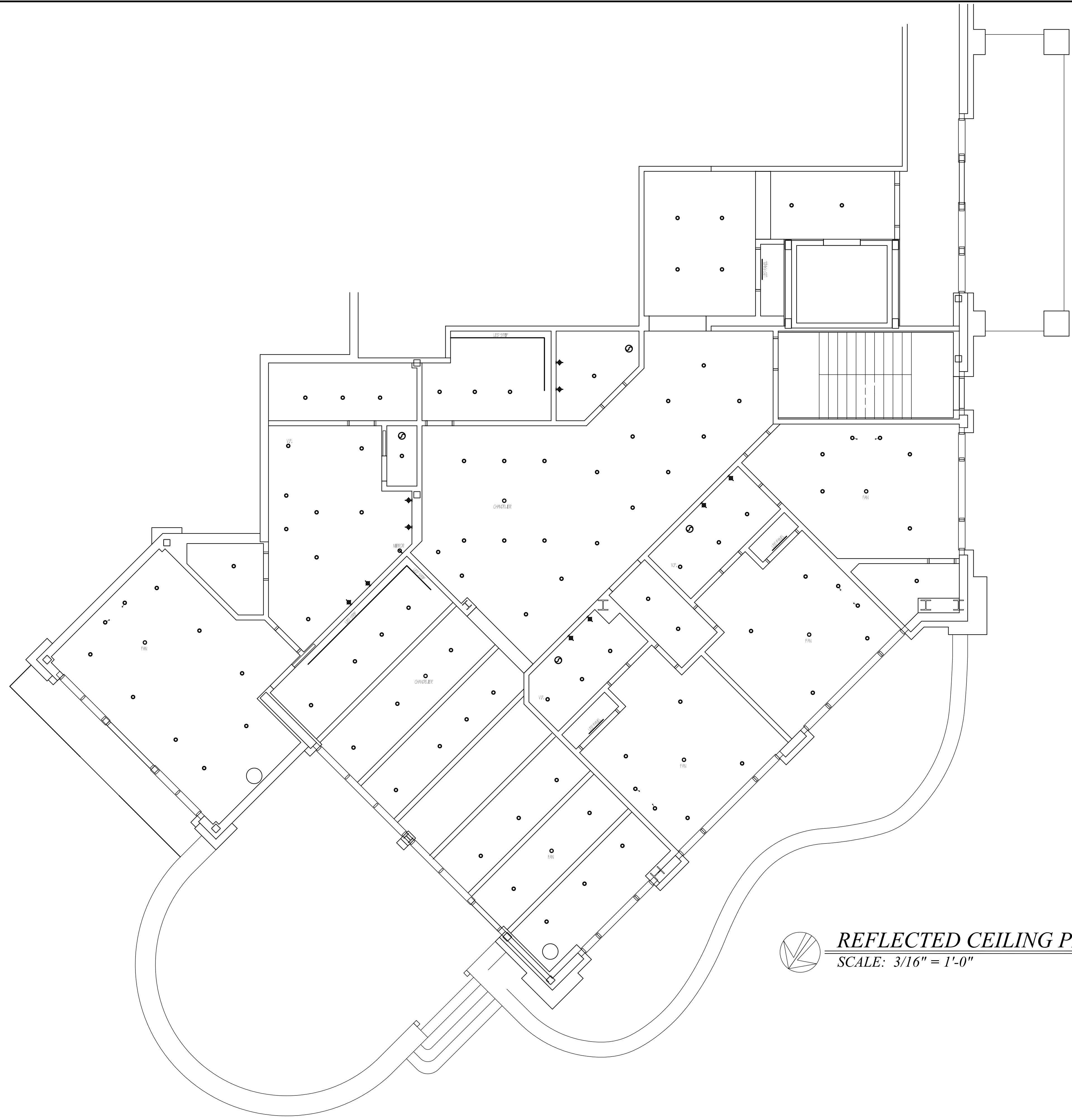

**REFLECTED CEILING PLAN**  
 SCALE: 3/16" = 1'-0"

|                                                   |                                                                                                             |                                                                                                                                 |  |                                                                              |                                                                                                                      |
|---------------------------------------------------|-------------------------------------------------------------------------------------------------------------|---------------------------------------------------------------------------------------------------------------------------------|--|------------------------------------------------------------------------------|----------------------------------------------------------------------------------------------------------------------|
| PAGE:<br><b>A-6</b><br>DRAWING:<br>REFLECTED CLG. | JOB TITLE:<br><b>INTERIOR MODIFICATIONS</b><br>SEE FOREVER VILLAGE UNIT CL 101<br>MOUNTAIN VILLAGE CO 81455 | <b>ONSHORE CONSTRUCTION AND DEVELOPMENT, INC.</b><br>938 NORTH OLD DIXIE HIGHWAY<br>JUPITER, FL 33458<br>OFFICE: (561) 744-8331 |  | SKEMATIC DESIGN: 02-02-2017<br>FINAL DESIGN: 03-14-2017<br>PERMIT SUBMITTAL: | THIS IS AN ORIGINAL DESIGN AND MUST NOT BE RELEASED OR COPIED UNLESS THE ORIGINAL HAS BEEN PAID OR JOB ORDER PLACED. |
|---------------------------------------------------|-------------------------------------------------------------------------------------------------------------|---------------------------------------------------------------------------------------------------------------------------------|--|------------------------------------------------------------------------------|----------------------------------------------------------------------------------------------------------------------|



| DESIGN CONDITIONS                     |                          |
|---------------------------------------|--------------------------|
| LOCATION                              | MOUNTAIN VILLAGE, CO     |
| IECC CLIMATE ZONE DESIGNATION         | 6B                       |
| ELEVATION                             | 9,545 FT.                |
| OUTDOOR DESIGN TEMPERATURES           | -8°F WINTER, 86°F SUMMER |
| INDOOR DESIGN TEMPERATURES            | 70°F WINTER, 72°F SUMMER |
| MAXIMUM FLOOR SURFACE TEMPERATURE     | 85°F                     |
| MAXIMUM SNOWFALL (IN./DAY)            | 14"                      |
| OUTDOOR DESIGN TEMPERATURE (SNOWMELT) | 10°F                     |

| INSULATION AND FENESTRATION REQUIREMENTS BY COMPONENT* (2009 IECC TABLE 402.1.1) |                       |                   |                 |                          |                   |               |                   |                       |                      |                          |
|----------------------------------------------------------------------------------|-----------------------|-------------------|-----------------|--------------------------|-------------------|---------------|-------------------|-----------------------|----------------------|--------------------------|
| CLIMATE ZONE                                                                     | FENESTRATION U-FACTOR | SKYLIGHT U-FACTOR | CEILING R-VALUE | WOOD FRAMED WALL R-VALUE | MASS WALL R-VALUE | FLOOR R-VALUE | CANITLIVER FLOORS | BASEMENT WALL R-VALUE | SLAB R-VALUE & DEPTH | CRAWL SPACE WALL R-VALUE |
| 6B                                                                               | 0.35                  | 0.60              | R 49            | R 20                     | R 24              | R 30          | R 40              | R 19                  | 10, 4 FT.            | 13                       |

\*FROM 2009 INTERNATIONAL ENERGY CONSERVATION CODE TABLE 402.1.1 AND SERIES 2010 TELLURIDE GREEN CODE

**Prescriptive Insulation Values**

Ceiling = R 49

Walls = R-20 + 5

Basement / Crawl Space Wall = R-19 or R-15 Continuous

Heated slab on grade = R-15

Fenestration = .32 u-factor or less

| FAN COIL UNIT SCHEDULE |                                       |                         |     |          |                           |     |             |                      |                       |            |       |                       |     |                      |              |     |                          |                            |         |
|------------------------|---------------------------------------|-------------------------|-----|----------|---------------------------|-----|-------------|----------------------|-----------------------|------------|-------|-----------------------|-----|----------------------|--------------|-----|--------------------------|----------------------------|---------|
| FC                     | MANUFACTURER & MODEL                  | UNIT DIMENSIONS (LxWxH) | CFM | O.A. CFM | HEATING (2-ROW H.W. COIL) |     |             | COOLING              |                       | ELECTRICAL |       | ASSOCIATED HUMIDIFIER |     |                      |              |     |                          |                            |         |
|                        |                                       |                         |     |          | HEATING (MBH)             | GPM | E.W.T. (°F) | TOTAL COOLING (TONS) | OUTDOOR UNIT          | VOLTAGE    | PHASE | MCA                   | MOP | MANUFACTURER & MODEL | POWER        | MCA | FRONT CLEARANCE REQUIRED | OUTPUT CAPACITY (LB./HOUR) | REMARKS |
| FC-1                   | LENNOX CBWMV-36B-070 WITH CH33-36B-2F | 28.5" X 17.5" X 40"     | 900 | 100      | 78                        | 6   | 180         | 3.0                  | LENNOX XC16-036-230-5 | 120        | 1     | 10.2                  | 15  | NORTEC RH2 DUCT      | 110-120/1/60 | 20  | 36"                      | 1-5                        | [1] [2] |
| FC-2                   | LENNOX CBWMV-36B-070 WITH CH33-36B-2F | 28.5" X 17.5" X 40"     | 900 | 100      | 78                        | 6   | 180         | 3.0                  | LENNOX XC16-036-230-5 | 120        | 1     | 10.2                  | 15  | NORTEC RH2 DUCT      | 110-120/1/60 | 20  | 36"                      | 1-5                        | [1] [2] |

[1] SPECIFY HIGH ALTITUDE WHEN ORDERING  
[2] OUTDOOR UNITS LOCATED IN PARKING GARAGE BELOW ON ELEVATED PLATFORMS ADJACENT EXISTING UNITS

| DOMESTIC HOT WATER STORAGE TANK SCHEDULE |                         |                                     |                     |            |                 |                      |                         |                            |                      |                        |
|------------------------------------------|-------------------------|-------------------------------------|---------------------|------------|-----------------|----------------------|-------------------------|----------------------------|----------------------|------------------------|
| DST                                      | MANUFACTURER & MODEL    | APPLICATION                         | STORAGE CAP. (GAL.) | TEMP. RISE | DOMESTIC OUTLET | HEATING WATER E.W.T. | CONT. RATING (GAL./HR.) | CIRCULATOR FLOW RATE (GPM) | BOILER INPUT (BTU/H) | DIMENSIONS (DIA. X H") |
| DST-1                                    | LOCHINVAR SQUIRE SIT080 | DOMESTIC HOT WATER w/ TIMER RECIRC. | 80                  | 90°F       | 140°F           | 180°F                | 266                     | 14.0                       | 160,000              | Ø 24" X 69"            |

| EXHAUST FAN SCHEDULE |                       |                                        |     |               |       |           |            |       |           |                  |         |
|----------------------|-----------------------|----------------------------------------|-----|---------------|-------|-----------|------------|-------|-----------|------------------|---------|
| EF                   | MANUFACTURER & MODEL  | APPLICATION                            | CFM | ESP (IN. H2O) | SONES | DUCT SIZE | ELECTRICAL |       |           | OPER. WT. (LBS.) | REMARKS |
|                      |                       |                                        |     |               |       |           | VOLTS      | PHASE | FAN WATTS |                  |         |
| EF-1                 | PANASONIC FV-05-11VK1 | EXHAUST FAN, FIELD SELECTABLE AIR FLOW | 50  | 0.5           | <0.3  | 4"        | 120        | 1     | 4.0       | 12               | [1] [2] |
| EF-2                 | TBD                   | RANGE HOOD EXHAUST FAN                 | -   | -             | -     | -         | -          | -     | -         | -                | [3]     |

[1] PROVIDE TIMER SWITCH FOR FAN OPERATION, PROVIDE BACKDRAFT DAMPER  
[2] COORDINATE LOCATION OF CEILING-MOUNTED EXHAUST FAN WITH LIGHTING DESIGNER OR ARCHITECT  
[3] PROVIDE BACKDRAFT DAMPER. FANS CAPABLE OF OVER 400 CFM REQUIRE MAKEUP AIR.

- GENERAL NOTES (MECHANICAL):**
- ALL WORK SHALL CONFORM TO THE 2012 VERSION OF THE INTERNATIONAL MECHANICAL CODE (IMC) AS WELL AS THE SAN MIGUEL COUNTY PRESCRIPTIVE GREEN CODE.
  - ALL DUCT CONSTRUCTION, GAUGES, METHODS OF HANGING AND SUPPORTING SHALL CONFORM TO THE LATEST SMACNA STANDARDS ANS CHAPTER 6 OF THE IMC.
  - ALL EXHAUST AND SUPPLY DUCTS SHALL BE CONSTRUCTED OF GALVANIZED SHEET METAL TO SMACNA 2" PRESSURE CLASS. ALL JOINTS AND SEAMS SHALL BE SEALED AIRTIGHT.
  - ALL ROUND EXHAUST, RETURN, AND SUPPLY DUCTS SHALL BE STANDARD GALVANIZED "SNAP - LOCK" PIPE WITH ALL CHANGES IN DIRECTION MADE VIA ADJUSTABLE ELBOWS. ALL JOINTS AND SEAMS SHALL BE SEALED AIRTIGHT.
  - COORDINATE THE LOCATION OF DUCTWORK WITH THE PLACEMENT OF THE LIGHT FIXTURES AND THE STRUCTURAL MEMBERS.
  - THE CONTRACTOR SHALL VERIFY ALL STRUCTURAL CONDITIONS FOR THE CEILING SPACE AND EXACT DUCT ROUTE PRIOR TO FABRICATION. VERIFY IN THE FIELD EXACT ROUTING OF DUCTWORK TO ALLOW PROPER LOCATION OF LIGHTS AS SHOWN.
  - ANY FRESH AIR INTAKE SHALL BE SEPARATED FROM THE BUILDING EXHAUST, FLUES, OR PLUMBING VENTS AS REQUIRED BY LOCAL CODE.
  - ANY FRAMING REQUIRED FOR DIFFUSER INSTALLATION IN HARD CEILINGS SHALL BE BY THE GENERAL CONTRACTOR.
  - ANY EQUIPMENT THAT IS SUBSTITUTED SHALL FIT IN THE SPACE PROVIDED, WITH ADEQUATE ROOM FOR SERVICING.
  - HVAC UNITS SHALL BE MOUNTED LEVEL.
  - FINAL HVAC SYSTEMS AND BALANCING SHALL BE PERFORMED BY THE OWNER'S INDEPENDENT AGENT.
  - SUPPLY SPECIFIED EQUIPMENT OR APPROVED EQUAL.
  - FLUE VENTS SHALL TERMINATE NO LESS THAN 10' FROM THE NEAREST FRESH AIR INTAKE. FIELD VERIFY AND OFFSET AS REQUIRED.
  - CONTRACTOR SHALL REVIEW ALL EQUIPMENT NAME PLATES AND INSTALLATION REQUIREMENTS PRIOR TO DOING WORK. EQUIPMENT IS TO BE INSTALLED PER MANUFACTURER'S SPECIFICATIONS.
  - HYDRONIC HEATING MANIFOLDS SHALL BE LOCATED AT BASE OF WALL BEHIND COVER. VERIFY FINAL LOCATION AND COVER STYLE WITH ARCHITECT.
  - IF REQUIRED, SIZE AND LOCATION OF ALL DUCT, VENTING, AND PLUMBING HOLES IN STRUCTURAL MEMBERS SHALL MEET MANUFACTURER GUIDELINES.
  - ANY QUESTIONS OR CONCERNS REGARDING EQUIPMENT, METHODS, OR INSTALLATIONS SHALL BE SUBMITTED IN WRITING TO THE ENGINEER AS A REQUEST FOR INSTALLATION FOR CLARIFICATION.

- INSTALLATION NOTES (HYDRONIC HEATING):**
- 2300** PROVIDE FLOOR SURFACE TEMPERATURE SENSOR AT WOOD FLOORING TO ENSURE WOOD TEMPERATURE DOES NOT EXCEED 85°F.
  - 2301** EXISTING 2" 180°F HW SUPPLY/RETURN TO BE USED FOR FAN COIL AND RADIANT HEATING.
  - 2302** UTILIZE CLOSET SPACE (OR PARTITION) FOR RADIANT HEATING ZONE VALVES, MIXING VALVES, CONTROL. ADJUST DOOR LOCATION AS NEEDED.
  - 2303** EXISTING TWO-HOUR FIRE-RESISTIVE FLOOR CONSTRUCTION NOT TO BE REMOVED AT THIS AREA. 4-11-2017

# 1 DESIGN CONDITIONS & MECHANICAL SCHEDULES

SCALE: NONE

**Design Conditions**

|                                              |                         |                      |
|----------------------------------------------|-------------------------|----------------------|
| Location: Mountain Village, Colorado         | Elevation: 9545 ft      | Daily Range: High    |
| Input Data: Outdoor Dry Bulb Indoor Dry Bulb | Latitude: 37° N         | Design Grains: -64   |
| Summer: 82 70                                | Heated Area 3364 Sq.Ft. | Design Hour: 3:00 PM |
| Winter: 0 70                                 | Cooled Area 3364 Sq.Ft. | Design Month: July   |

**Heat/Loss Summary**

|                            | Loss               | Sensible Gain                               | Latent Gain |
|----------------------------|--------------------|---------------------------------------------|-------------|
| Walls                      | 9773               | 149                                         | 0           |
| Windows                    | 7121               | 3989                                        | 0           |
| Doors                      | 3712               | 1116                                        | 0           |
| Ceilings                   | 0                  | 0                                           | 0           |
| Skylights                  | 0                  | 0                                           | 0           |
| Floors                     | 86657              | 2725                                        | 0           |
| Room Internal Loads        | 0                  | 51546                                       | 10190       |
| Blower Load                | 0                  | 1707                                        | 0           |
| Hot Water Piping Load      | 0                  | 0                                           | 0           |
| Winter Humidification Load | 0                  | 0                                           | 0           |
| Infiltration               | 12435              | 998                                         | -3292       |
| Ventilation                | 0                  | 0                                           | 0           |
| Supply Duct EHLF=0 ESGF=0  | 0                  | 0                                           | n/a         |
| Return Duct EHLF=0 ESGF=0  | 0                  | 0                                           | 0           |
| <b>Subtotal</b>            | <b>119698</b>      | <b>62230</b>                                | <b>6898</b> |
| <b>Total Heating</b>       | <b>119698 Btuh</b> | <b>36 kw of electric heat</b>               |             |
| <b>Total Cooling</b>       | <b>69128 Btuh</b>  | <b>235 Linear ft. of Hydronic Baseboard</b> |             |

4-11-2017

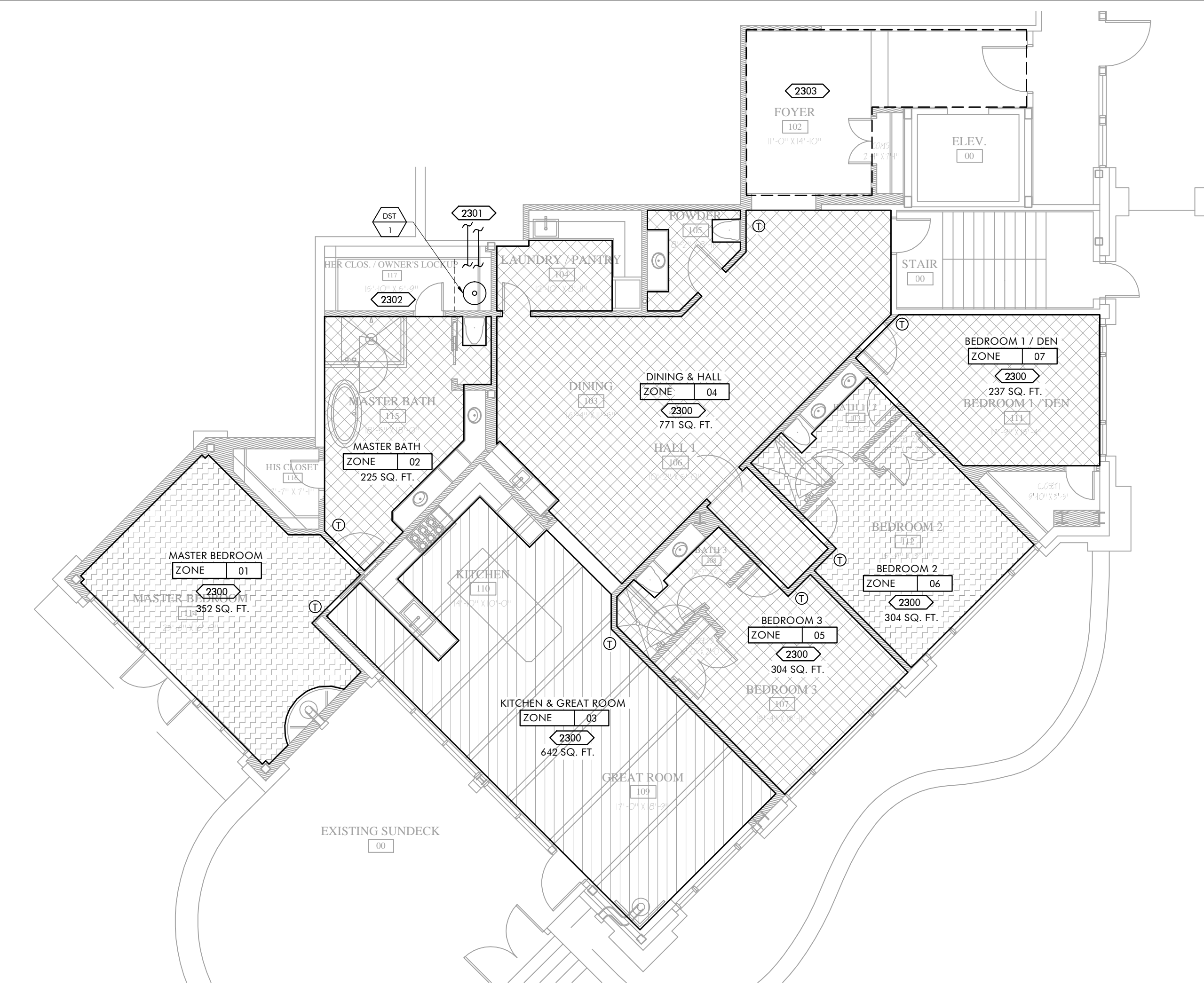

| RADIANT HEATING SCHEDULE     |                      |         |                       |         |
|------------------------------|----------------------|---------|-----------------------|---------|
| HYDRONIC HEATING ZONES       |                      |         |                       |         |
| ZONE                         | AREA DESCRIPTION     | SPACING | HEATED AREA (SQ. FT.) | REMARKS |
| 01                           | MASTER BEDROOM       | 9"      | 352                   | [1]     |
| 02                           | MASTER BATHROOM      | 9"      | 225                   | [1]     |
| 03                           | KITCHEN & GREAT ROOM | 9"      | 642                   | [1]     |
| 04                           | DINING & HALL        | 9"      | 771                   | [1]     |
| 05                           | BEDROOM 3            | 9"      | 304                   | [1]     |
| 06                           | BEDROOM 2            | 9"      | 304                   | [1]     |
| 07                           | BEDROOM 1 / DEN      | 9"      | 237                   | [1]     |
| TOTAL RADIANT HEATING (S.F.) |                      |         | 2835                  |         |

[1] MANIFOLDS FIELD-LOCATED AND FINAL LOCATION TO BE APPROVED BY ARCHITECT

| LEGEND (HYDRONIC HEATING) |                                                  |
|---------------------------|--------------------------------------------------|
| Ⓢ                         | WALL-MOUNTED TEMPERATURE SENSOR (HVAC & RADIANT) |
| 2300                      | INSTALLATION NOTE                                |
| 2302                      | CONTROL NOTE                                     |

# 2 LOAD CALCULATION

SCALE: NONE

# 3 HYDRONIC HEATING LAYOUT

SCALE: 1/8" = 1'-0"

**HCE**  
HUGHES CONSULTING ENGINEERING, PA  
HVAC - Electrical - Plumbing - Energy Studies

**Steven Hughes, PE**  
TELLURIDE OFFICE  
Dimitri Merrill, E.I.T.  
220 West Colorado Ave.  
Telluride, CO 81435  
ph: (970) 239-1949  
fax: (785) 842-2492  
dimitri@hce-pa.com



SEE FOREVER TENANT FINISH

117 SUNNY RIDGE PLACE

MOUNTAIN VILLAGE, CO

| No. | Description            | Date      |
|-----|------------------------|-----------|
| 1   | PRICING/PRELIM. REVIEW | 2-17-2017 |
| 2   | UPDATED BACKGROUNDS    | 3-17-2017 |
| 3   | COMMENT UPDATES        | 4-11-2017 |

| Sheet Index |                                                                                    |
|-------------|------------------------------------------------------------------------------------|
| M1          | MECHANICAL SCHEDULES, DESIGN CONDITIONS, LOAD CALCULATION, HYDRONIC HEATING LAYOUT |
| M2          | MECHANICAL LAYOUT                                                                  |

| MECHANICAL SCHEDULES, DESIGN CONDITIONS, HEATING ZONES |           |
|--------------------------------------------------------|-----------|
| Date                                                   | 4-11-2017 |
| Drawn by                                               | DJM       |
| Checked by                                             | SCH       |
| <b>M1</b>                                              |           |
| Scale                                                  | AS NOTED  |



| ID<br>CFM | CFM RANGE | APPLICATION |        |          | MANUFACTURER & MODEL                         | GRILLE/BOOT SIZE<br>(LENGTH" X WIDTH/HEIGHT") | OPENING SIZE<br>(L" X W/H") | FINISH | REMARKS     |
|-----------|-----------|-------------|--------|----------|----------------------------------------------|-----------------------------------------------|-----------------------------|--------|-------------|
|           |           | SUPPLY      | RETURN | TRANSFER |                                              |                                               |                             |        |             |
| S-1       | <50       | X           |        |          | ARCHITECTURAL GRILLE AG10-B FRAME BAR GRILLE | 8" X 4"                                       | 8-1/16" X 4-1/16"           | TBD    | {1} {2} {3} |
| S-2       | <50       | X           |        |          | ARCHITECTURAL GRILLE AG10-B FRAME BAR GRILLE | 12" X 2" (TOE KICK)                           | 12-1/16" X 2-1/16"          | TBD    | {1} {2} {3} |
| S-3       | 50-75     | X           |        |          | ARCHITECTURAL GRILLE AG10-B FRAME BAR GRILLE | 12" X 4"                                      | 12-1/16" X 4-1/16"          | TBD    | {1} {2} {3} |
| S-4       | 75-100    | X           |        |          | ARCHITECTURAL GRILLE AG10-B FRAME BAR GRILLE | 24" X 4"                                      | 24-1/16" X 4-1/16"          | TBD    | {1} {2} {3} |
| S-5       | 100-150   | X           |        |          | ARCHITECTURAL GRILLE AG10-B FRAME BAR GRILLE | 30" X 4"                                      | 30-1/16" X 4-1/16"          | TBD    | {1} {2} {3} |
| S-6       | MUA       | X           |        |          | ARCHITECTURAL GRILLE AG10-B FRAME BAR GRILLE | 14" X 12"                                     | 14-1/16" X 8-1/16"          | TBD    | {1} {2} {3} |
| R-1       | 100       |             | X      |          | ARCHITECTURAL GRILLE AG10-B FRAME BAR GRILLE | 12" X 4"                                      | 12-1/16" X 4-1/16"          | TBD    | {1} {2} {3} |
| R-2       | 100-200   |             | X      |          | ARCHITECTURAL GRILLE AG10-B FRAME BAR GRILLE | 24" X 4"                                      | 24-1/16" X 4-1/16"          | TBD    | {1} {2} {3} |
| R-3       | 200-700   |             | X      |          | ARCHITECTURAL GRILLE AG10-B FRAME BAR GRILLE | 12" X 14"                                     | 12-1/16" X 14-1/16"         | TBD    | {1} {2} {3} |
| T-1       | 50-100    |             |        | X        | ARCHITECTURAL GRILLE AG10-B FRAME BAR GRILLE | 12" X 4"                                      | 12-1/16" X 4-1/16"          | TBD    | {1} {2} {3} |

{1} VERIFY FINISH, STYLE, AND INSTALLATION WITH INTERIORS  
 {2} SEE GRILLE DETAILS FOR SIZING AND STYLE INFORMATION  
 {3} MANUFACTURER USES "X" TO DESIGNATE LENGTH AND "Y" TO DESIGNATE WIDTH/HEIGHT. MANUFACTURER RECOMMENDS OPENING IS 1/16" LARGER THAN GRILLE

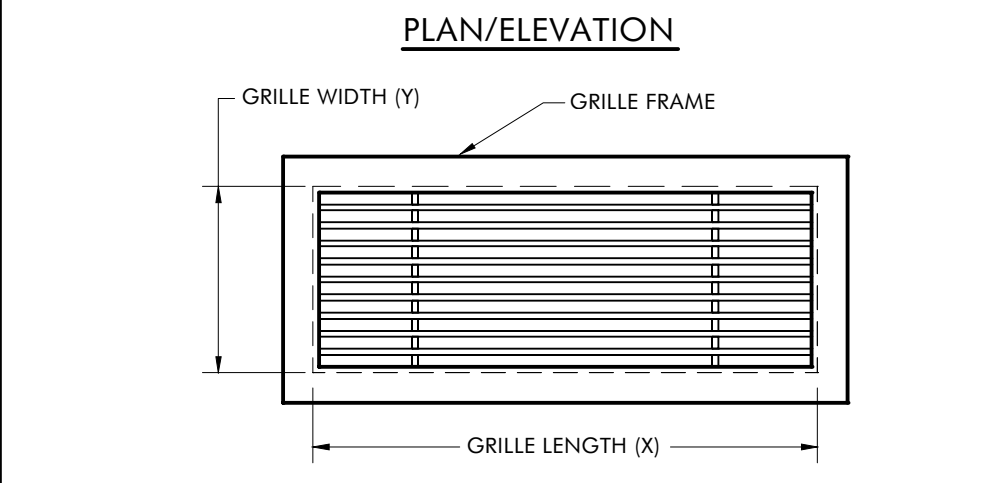
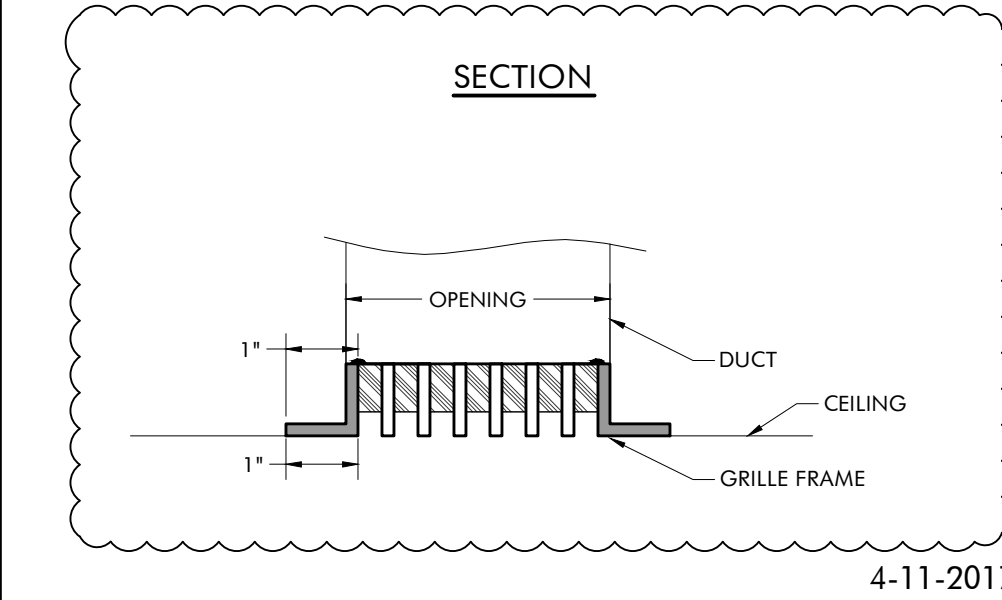

- INSTALLATION NOTES (MECHANICAL):**
- 2300 VERIFY MIN. 3'-0" CLEARANCE TO OPERABLE WINDOW.
  - 2301 PROVIDE RECESSED DRYER BOX AT DRYER VENTING. PROVIDE ACCESSIBLE DRYER BOOSTER FAN DUE TO CLOSEST EXTERIOR WALL BEING OVER 25' FROM DRYER. FIELD VERIFY ABILITY TO ROUTE TO EAST WALL AS SHOWN.
  - 2302 FIELD-VERIFY BATHROOM EXHAUST FAN ROUTING. VERIFY EXTERIOR TERMINATION STYLE WITH ARCHITECT.
  - 2303 DUCTWORK AND GRILLES ARE LOCATED WITHIN THE CEILING AND DO NOT PENETRATE THE FIRE-RATED ASSEMBLY ABOVE.
- 4-11-2017

**SYMBOLS LEGEND (MECHANICAL)**

|           |                                                      |
|-----------|------------------------------------------------------|
| Ⓜ         | WALL-MOUNTED REMOTE TEMPERATURE SENSOR               |
| Ⓛ         | MECHANICAL CONTROL ZONE DAMPER OR OUTSIDE AIR DAMPER |
| 28" X 10" | DUCT OR GRILLE SIZE (W" X H")                        |
| ID<br>CFM | SUPPLY/RETURN GRILLE AND AIR VOLUME PROVIDED         |
| 2300      | INSTALLATION NOTE, SEE INSTALLATION NOTE LIST        |
| 103       | CONTROL COORDINATION NOTES                           |
| Ⓢ         | WALL SWITCH WITH TIMER                               |
| Ⓜ         | HUMIDISTAT CONTROL SWITCH (ON AT 50% OR HIGHER R.H.) |

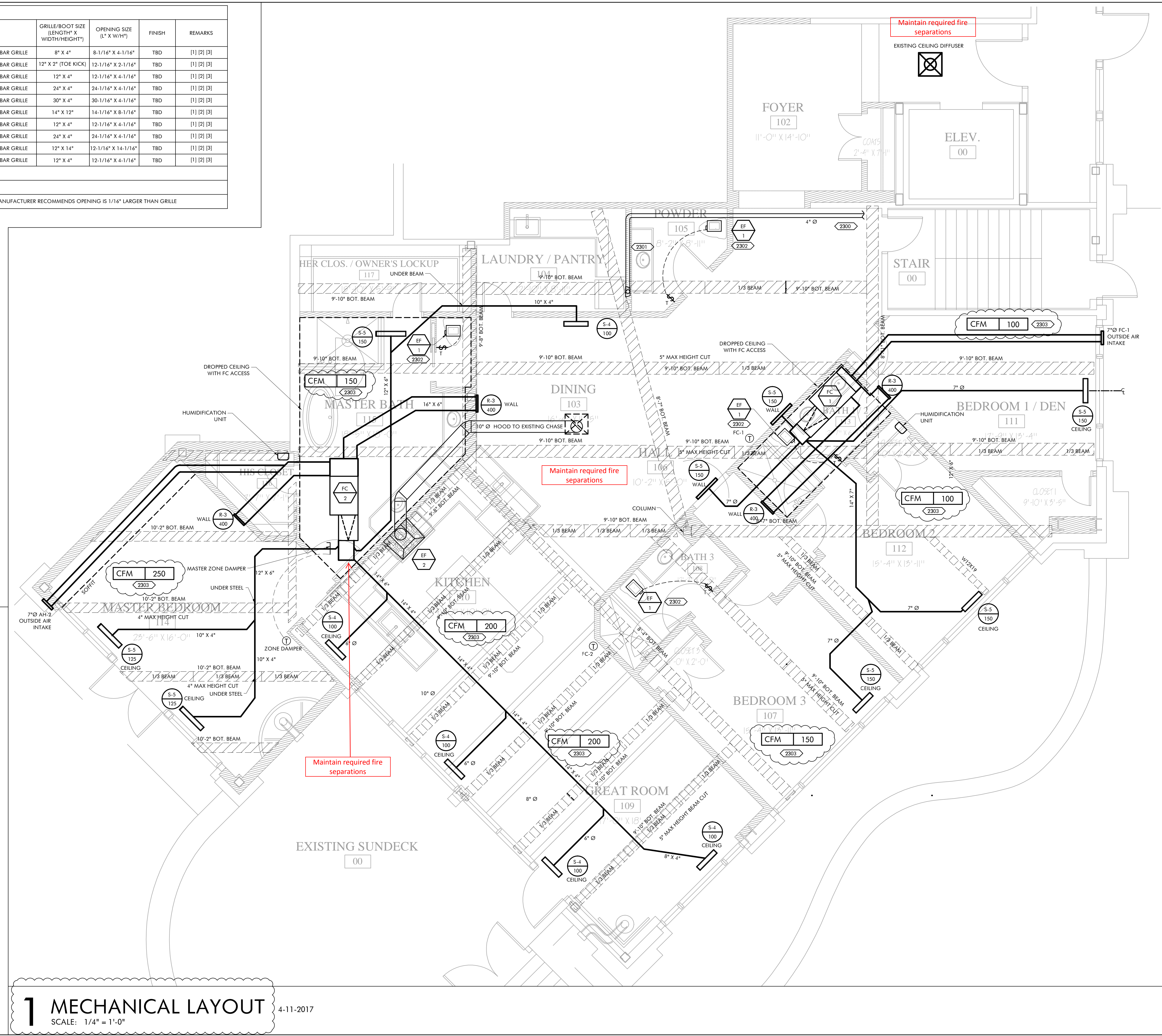

**1 MECHANICAL LAYOUT** 4-11-2017  
 SCALE: 1/4" = 1'-0"

**HCE**  
 HUGHES CONSULTING ENGINEERING, PA  
 HVAC - Electrical - Plumbing - Energy Studies  
**Steven Hughes, PE**  
 TELLURIDE OFFICE  
 Dimitri Merrill, E.I.T.  
 220 West Colorado Ave.  
 Telluride, CO 81435  
 ph: (970) 239-1949  
 fax: (785) 842-2492  
 dimitri@hce-pa.com



**SEE FOREVER TENANT FINISH**  
 117 SUNNY RIDGE PLACE  
 MOUNTAIN VILLAGE, CO

| No. | Description            | Date      |
|-----|------------------------|-----------|
| 1   | PRICING/PRELIM. REVIEW | 2-17-2017 |
| 2   | UPDATED BACKGROUNDS    | 3-17-2017 |
| 3   | COMMENT UPDATES        | 4-11-2017 |

**Sheet Index**

|               |                                                                                    |
|---------------|------------------------------------------------------------------------------------|
| MECHANICAL M1 | MECHANICAL SCHEDULES, DESIGN CONDITIONS, LOAD CALCULATION, HYDRONIC HEATING LAYOUT |
| M2            | MECHANICAL LAYOUT                                                                  |

**TENANT FINISH MECHANICAL LAYOUT**

|            |           |
|------------|-----------|
| Date       | 4-11-2017 |
| Drawn by   | DJM       |
| Checked by | SCH       |
| Scale      | AS NOTED  |

**M2**



AFCI required per NEC for 125 Volt, 15 and 20 amp circuits excluding garage, storage, unfinished areas, exterior

Smoke, CO detectors shall be installed per CO HB 1091 and per 2012 IRC requirements.

**ELECTRICAL KEY**

|  |                                          |  |                                                   |
|--|------------------------------------------|--|---------------------------------------------------|
|  | DUPLEX OUTLET                            |  | EXHAUST FAN                                       |
|  | DUPLEX OUTLET ABOVE COUNTER              |  | TELEVISION                                        |
|  | GROUND FAULT INTERRUPTER                 |  | REINFORCED FAN BOX w/SWIPE                        |
|  | WEATHERPROOF DUPLEX OUTLET               |  | GARBAGE DISPOSAL                                  |
|  | DEDICATED OUTLET                         |  | ELECTRICAL PANEL                                  |
|  | 220 VOLT SWITCH                          |  | CARBON MONOXIDE / SMOKE DETECTOR COMBINATION UNIT |
|  | WALL SWITCH                              |  | SMOKE DETECTOR                                    |
|  | THREE-WAY SWITCH                         |  |                                                   |
|  | FOUR-WAY SWITCH                          |  |                                                   |
|  | DECORATIVE CEILING MOUNTED LIGHT FIXTURE |  |                                                   |
|  | WALL MOUNTED LIGHT FIXTURE               |  |                                                   |
|  | 4" RECESSED LIGHT FIXTURE                |  |                                                   |
|  | 6" RECESSED LIGHT FIXTURE                |  |                                                   |

| EXT NO. | LOAD DESCRIPTION         | CONC. | CODE  | WVA | WRE  | C.B. | C.B. | WRE  | WVA | CODE | CONC. | LOAD DESCRIPTION       | EXT NO. |
|---------|--------------------------|-------|-------|-----|------|------|------|------|-----|------|-------|------------------------|---------|
| 1       | GAS RANGE                | 1/2"  | A     | 1.0 | 12   | 20/1 | A    | 20/1 | 1.5 | A    | 1/2"  | DISHWASHER             | 2       |
| 3       | REFRIGERATOR             | 1/2"  | A     | 1.2 | 20/1 | B    | 20/1 | 1.0  | 0.8 | A    | 1/2"  | DISHWASHER             | 4       |
| 5       | KITCHEN SMALL APPL.      | 1/2"  | S     | 1.5 | 12   | 20/1 | A    | 20/1 | 1.2 | A    | 1/2"  | DISHWASHER             | 6       |
| 7       | KITCHEN SMALL APPL.      | 1/2"  | S     | 1.5 | 12   | 20/1 | B    | 20/1 | 1.0 | A    | 1/2"  | DISHWASHER             | 8       |
| 9       | DW                       | 3/4"  | S     | 2.5 | 10   | 30/2 | A    | 20/1 | 1.0 | A    | 1/2"  | LAU. WINE COOLER       | 10      |
| 11      | WASHER                   | 3/4"  | S     | 2.5 | 10   | ---  | B    | 20/1 | 1.0 | A    | 1/2"  | ICE MACHINE            | 12      |
| 13      | WASHER / LAUNDRY DED.    | 1/2"  | S     | 1.5 | 12   | 20/1 | A    | 30/2 | 1.0 | A    | 3/4"  | HOT WATER HEATER       | 14      |
| 15      | DINING ROOM REC.         | 1/2"  | S     | 1.5 | 12   | 20/1 | B    | ---  | 1.0 | A    | 3/4"  | ---                    | 16      |
| 17      | LAUNDRY ROOM REC. & LUC. | 1/2"  | L & R | --- | 12   | 20/1 | A    | 30/2 | 1.0 | A    | 3/4"  | ---                    | 18      |
| 19      | POWDER BATH LUC.         | 1/2"  | L & R | --- | 12   | 20/1 | B    | ---  | 0.5 | H    | 3/4"  | ---                    | 20      |
| 21      | LAUNDRY ROOM REC. & LUC. | 1/2"  | L & R | --- | 12   | 20/1 | A    | 30/2 | 1.0 | A    | 3/4"  | ---                    | 22      |
| 23      | MASTER BATH LUC.         | 1/2"  | L & R | --- | 12   | 20/1 | B    | ---  | 0.5 | H    | 3/4"  | ---                    | 24      |
| 25      | MASTER WC / TOILET LUC.  | 1/2"  | L & R | --- | 12   | 20/1 | B    | ---  | 0.5 | H    | 3/4"  | ---                    | 26      |
| 27      | WASHER REC. & LUC.       | 1/2"  | L & R | --- | 12   | 20/1 | A    | 20/1 | 1.0 | A    | 1/2"  | LAUNDRY ROOM REC. LUC. | 28      |
| 29      | WASHER REC. & LUC.       | 1/2"  | L & R | --- | 12   | 20/1 | B    | ---  | 1.0 | A    | 1/2"  | MASTER BATHROOM TOILET | 30      |
| 31      | FAMILY ROOM REC. & LUC.  | 1/2"  | L & R | --- | 12   | 20/1 | B    | ---  | 1.0 | A    | 1/2"  | DISHWASHER             | 32      |
| 33      | DINING ROOM LUC.         | 1/2"  | L & R | --- | 12   | 20/1 | A    | 20/1 | 1.0 | A    | 1/2"  | GAS FIREPLACE #1       | 34      |
| 35      | BEDROOM 2 REC. & LUC.    | 1/2"  | L & R | --- | 12   | 20/1 | B    | ---  | 1.0 | A    | 1/2"  | GAS FIREPLACE #2       | 36      |
| 37      | BEDROOM 2 REC. & LUC.    | 1/2"  | L & R | --- | 12   | 20/1 | A    | ---  | 1.0 | A    | 1/2"  | GAS FIREPLACE #2       | 38      |
| 39      | BEDROOM 1 REC. & LUC.    | 1/2"  | L & R | --- | 12   | 20/1 | B    | ---  | 1.0 | A    | 1/2"  | GAS FIREPLACE #2       | 40      |
| 41      | BEDROOM 1 REC. & LUC.    | 1/2"  | L & R | --- | 12   | 20/1 | A    | ---  | 1.0 | A    | 1/2"  | GAS FIREPLACE #2       | 42      |

|                            |                  |
|----------------------------|------------------|
| WVA FACTOR                 | 30 x 3000 = 150  |
| L - LIGHTING & RECEPT.     | 80 x 1.00 = 80   |
| S - SMALL APPL. DISH.      | 80 x 1.00 = 80   |
| LA & SA APPL. (TOTAL)      | 160              |
| LA & SA APPL. (MAX)        | 160              |
| LA & SA APPL. (MIN)        | 160              |
| A - APPLANCE LOADS         | 127 x 0.75 = 95  |
| D - DISHWASHER             | 5.0 x 1.00 = 5.0 |
| X - KITCHEN COOKING EQUIP. | 1.0 x 0.80 = 0.8 |
| C - COOL                   | N/A              |
| H - HEAT                   | 104 x 5.00 = 520 |
| TOTAL DEMAND WVA           | 838              |

|                   |      |
|-------------------|------|
| TOTAL KW PHASE A: | 18.0 |
| TOTAL KW PHASE B: | 18.0 |

|                    |      |
|--------------------|------|
| PANEL CALCULATIONS |      |
| DEMAND WVA         | 30.8 |
| PHASE 1 KW         | 30.8 |
| PHASE 2 KW         | 30.8 |
| PHASE 3 KW         | 30.8 |

**GENERAL ELECTRICAL NOTES**

THIS DRAWING COMPLIES WITH THE 2011 NATIONAL ELECTRICAL CODE. ALL MATERIALS AND INSTALLATIONS SHALL CONFORM TO THESE STANDARDS. THE CONTRACTOR SHALL BE RESPONSIBLE FOR OBTAINING ALL NECESSARY PERMITS AND FOR OBTAINING ALL OTHER APPLICABLE CODES, LAWS, REGULATIONS AND ORDINANCES. IN THE EVENT THAT ANY REQUIREMENT OF THESE STANDARDS OR ANY OTHER APPLICABLE CODES, LAWS, REGULATIONS AND ORDINANCES IS IN CONFLICT WITH ANY REQUIREMENT OF THESE STANDARDS, THE CONTRACTOR SHALL BE RESPONSIBLE FOR OBTAINING ALL NECESSARY PERMITS AND FOR OBTAINING ALL OTHER APPLICABLE CODES, LAWS, REGULATIONS AND ORDINANCES. IN THE EVENT THAT ANY REQUIREMENT OF THESE STANDARDS OR ANY OTHER APPLICABLE CODES, LAWS, REGULATIONS AND ORDINANCES IS IN CONFLICT WITH ANY REQUIREMENT OF THESE STANDARDS, THE CONTRACTOR SHALL BE RESPONSIBLE FOR OBTAINING ALL NECESSARY PERMITS AND FOR OBTAINING ALL OTHER APPLICABLE CODES, LAWS, REGULATIONS AND ORDINANCES.

PER 2011 NEC SECTION 210.8(B) ALL 120-VOLT, SINGLE-PHASE 15- AND 20-AMPERE BRANCH CIRCUITS SUPPLYING OUTLETS INSTALLED IN DWELLING UNIT FAMILY ROOMS, DINING ROOMS, LIVING ROOMS, PARLORS, LIBRARIES, DEN, BEDROOMS, SUN ROOMS, RECREATION ROOMS, CLOSETS, HALLWAYS, OR SMALL ROOMS OR JARAS SHALL BE PROTECTED BY A LISTED ARC-FAULT CIRCUIT INTERRUPTER, COMBINATION-TYPE INSTALLED TO PROVIDE PROTECTION OF THE BRANCH CIRCUIT.

ELECTRICAL CONTRACTOR SHALL INSTALL TAMPER RESISTANT RECEPTACLES AS REQUIRED BY SECTION 406.11 OF N.E.C. 2014

ALL 120V RECEPTACLES WITHIN 6' OF A SINK SHALL BE GFCI PROTECTED.

ELECTRICAL CONTRACTOR SHALL BE RESPONSIBLE FOR FURNISHING AND INSTALLING ALL ITEMS, FITTINGS, FIXTURES AND HARDWARE AS NECESSARY TO PROVIDE A COMPLETE ELECTRICAL SYSTEM.

THESE PLANS ARE BASED UPON INFORMATION PROVIDED BY OTHERS AND ASSUMPTIONS HAVE BEEN MADE TO BE MADE REGARDING MANY CONSTRUCTION ELEMENTS. THESE PLANS DO NOT SHOW EVERY DETAIL OF CONSTRUCTION AND ARE PROVIDED WITHOUT ANY WARRANTY OF MERCHANTABILITY OR FITNESS FOR A PARTICULAR PURPOSE, WHETHER EXPRESS OR IMPLIED.

READ ALL SPECIFICATIONS AND REVIEW ALL BUILDING PLANS AND RISER DIAGRAMS.

PRIOR TO BID, VERIFY ALL ELECTRICAL REQUIREMENTS WITH GENERAL CONTRACTOR, ARCHITECT, EQUIPMENT SUPPLIERS AND OTHER SUBCONTRACTORS.

ELECTRICAL CONTRACTOR TO SUPPLY AND INSTALL:

- ALL DISCONNECTS AND OTHER DEVICES REQUIRED BY APPLICABLE CODES.
- ALL JUNCTION BOXES, OUTLETS, PLATES, SWITCHES ETC NOT BUILT INTO EQUIPMENT.
- WEATHERPROOF DEVICES AS REQUIRED BY APPLICABLE CODES.

TO ALL PHASES AND CONDS AS NOTED HEREIN. ALL CONDS TO BE NEMA RATED AND UL LISTED FOR THE STATED USE.

E. SHUNT TRIP CIRCUIT BREAKERS AND DISCONNECTS AS NOTED AND FOR FIRE CONTROL SYSTEM SHUTOFF OF KITCHEN EQUIPMENT.

F. ALL BULBS AND LAMPS AS REQUIRED FOR LIGHTING FIXTURES.

ALL ROUGH AND TRIM INSTALLATIONS TO BE IN ACCORDANCE WITH INSTRUCTIONS CONTAINED IN MANUALS PROVIDED BY PRODUCT MANUFACTURER AND ALL APPLICABLE CODES, ORDINANCES AND REGULATIONS. CONTRACTOR TO CONFIRM ALL FIXTURE AND DEVICE COUNTS PRIOR TO ORDERING.

WIRING LAYOUTS IN THESE DRAWINGS ARE INDICATED ONLY. INSTALLER IS RESPONSIBLE FOR DETERMINING THE BEST LOCATION AND WIRING METHODS TO BE USED. CONTRACTOR SHALL VERIFY ALL PANEL LOCATIONS AND ASSURE THAT THEY MEET ALL APPLICABLE CODES AND REGULATIONS.

CONDUIT TERMINATIONS AT TERMINAL BOARDS SHALL HAVE BUSHED CONDUIT ENDS.

PULL STRINGS SHALL BE INSTALLED IN ALL EMPTY CONDUITS.

ALL CIRCUITS SHALL HAVE SEPARATE NEUTRALS, NO MULTI-WIRE BRANCH CIRCUITS SHALL BE USED.

**ARC FAULT CIRCUIT NOTE:**  
 PROVIDE ARC FAULT CIRCUIT INTERRUPTER (AFCI) PROTECTION AT ALL LIVING AREAS PER NEC REQUIREMENTS

**SMOKE DETECTOR NOTE:**  
 ALL SMOKE DETECTORS ARE HARDWIRED WITH BATTERY BACKUP AND INTER-CONNECTED

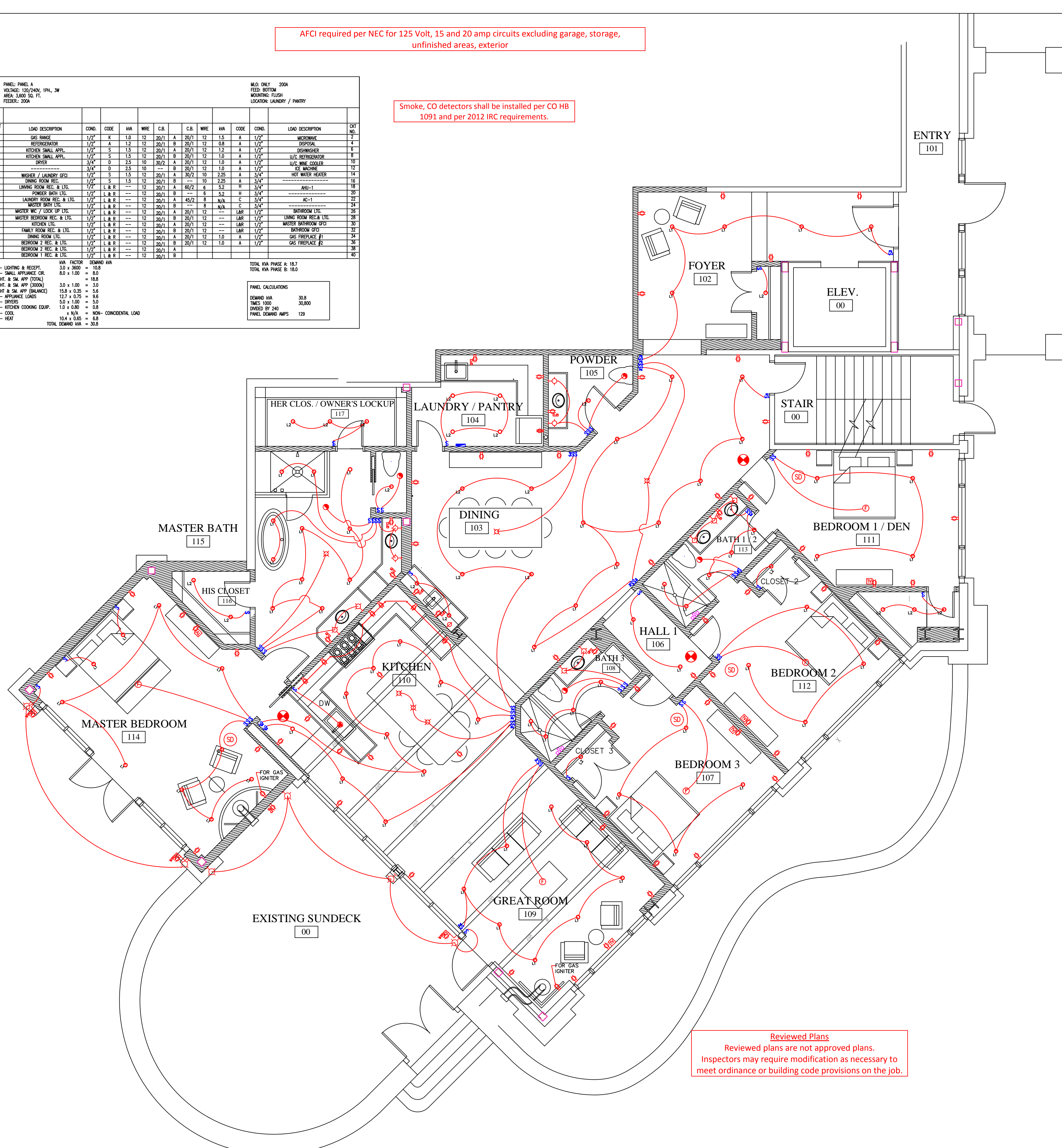

Reviewed Plans  
 Reviewed plans are not approved plans.  
 Inspectors may require modification as necessary to meet ordinance or building code provisions on the job.

General Notes

---

AS PER DESIGNER & CLIENT 3/21/17

REVISION / DESCRIPTION Date

---

**Palm Beach ELECTRONICS**

11320 Fortune Circle  
 Suite G6  
 Wellington, FL 33414  
 (561) 902-1648  
 PalmBeachElectronics.com

Project Name and Address

**COLORADO RESIDENCE**

Designed by  
**Jerry Lankford**

Project  
**COLORADO**

Date  
**01-24-2017**

Scale  
**3/16"=1'-0"**

Sheet  
**E1**

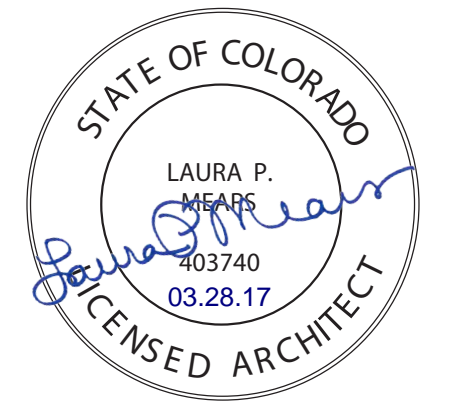

**01 FLOORPLAN - ELECTRICAL**  
 SCALE: 3/16" = 1'-0"



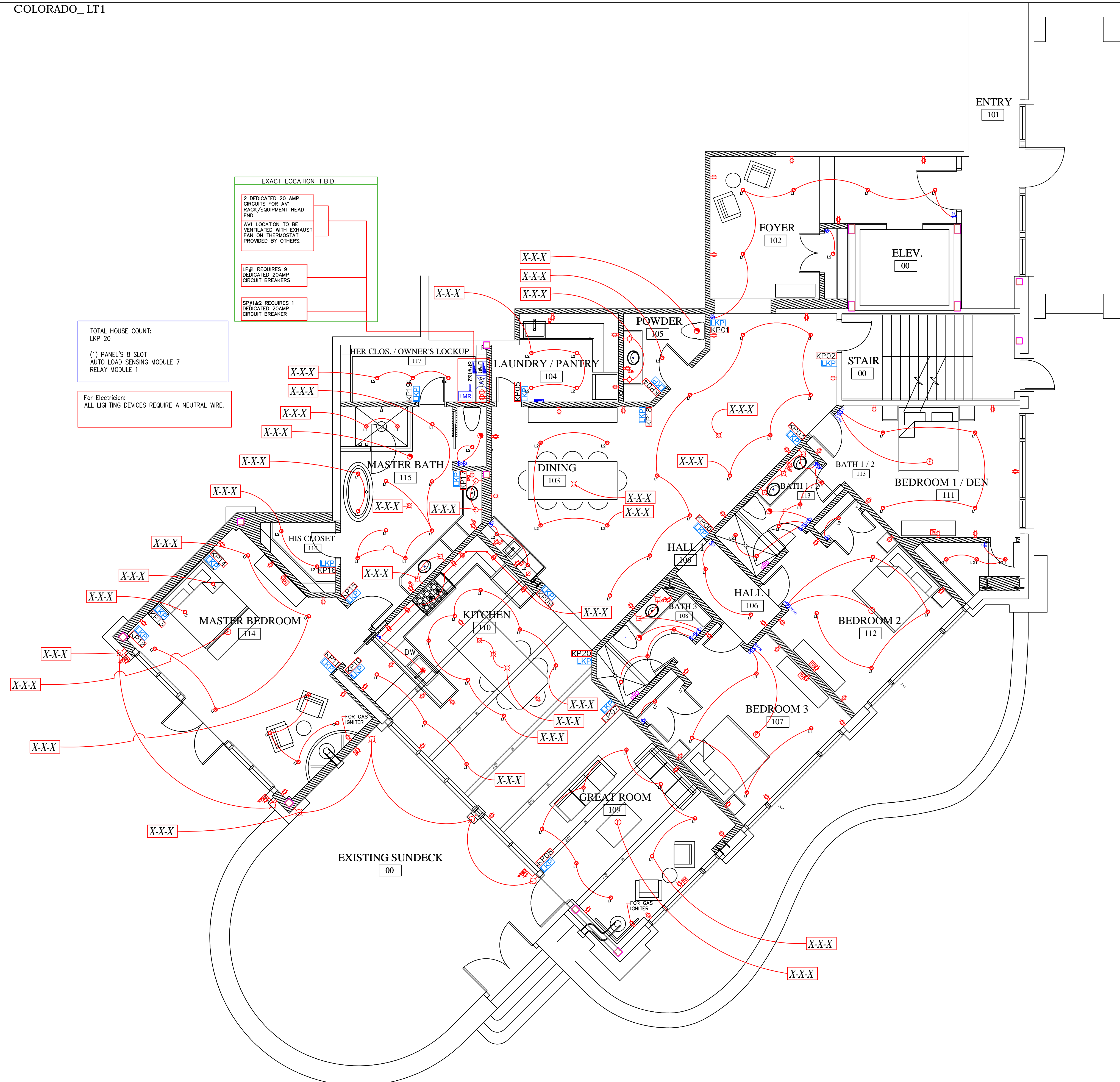

EXACT LOCATION T.B.D.

2 DEDICATED 20 AMP CIRCUITS FOR AV1 RACK/EQUIPMENT HEAD END.  
AV1 LOCATION TO BE VENTILATED WITH EXHAUST FAN ON THERMOSTAT PROVIDED BY OTHERS.

LP#1 REQUIRES 8 DEDICATED 20AMP CIRCUIT BREAKERS

SP#1&2 REQUIRES 1 DEDICATED 20AMP CIRCUIT BREAKER

TOTAL HOUSE COUNT:  
LKP 20  
(1) PANEL'S B SLOT AUTO LOAD SENSING MODULE 7 RELAY MODULE 1

For Electrician:  
ALL LIGHTING DEVICES REQUIRE A NEUTRAL WIRE.

General Notes

**DEVICE LEGEND**

|  |                                     |
|--|-------------------------------------|
|  | LUTRON WIRED LIGHTING KEYPAD        |
|  | WIRELESS WALL SWITCH                |
|  | WIRELESS WALL DIMMER                |
|  | WIRELESS REMOTE FAN CONTROL         |
|  | WIRELESS REMOTE FAN CONTROL         |
|  | LUTRON RADIO RA2 MAIN REPEATER      |
|  | LUTRON RADIO RA2 AUX. REPEATER      |
|  | CENTRALIZED LIGHTING PANEL PREWIRE: |
|  | SHADE POWER PANEL                   |
|  | MAIN RACK / AV HOME RUN LOCATION    |

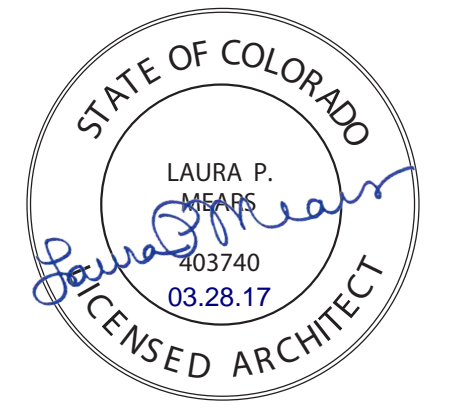

|                          |         |
|--------------------------|---------|
| AS PER DESIGNER & CLIENT | 3/21/17 |
| REVISION / DESCRIPTION   | Date    |

**Palm Beach ELECTRONICS**

11320 Fortune Circle  
Suite G6  
Wellington, FL 33414  
(561)-902-1648  
PalmBeachElectronics.com

Project Name and Address

**COLORADO RESIDENCE**

Designed by  
**Jerry Lankford**

|                               |                     |
|-------------------------------|---------------------|
| Project<br><b>COLORADO</b>    | Reviewed by         |
| Date<br><b>01-24-2017</b>     |                     |
| Scale<br><b>3/16" = 1'-0"</b> | Sheet<br><b>LT1</b> |

**01 FLOORPLAN - LV LIGHTING**  
SCALE: 3/16" = 1'-0"



TOTAL HOUSE COUNT:  
LKP 20  
(1) PANEL'S 8 SLOT  
AUTO LOAD SENSING MODULE 7  
RELAY MODULE 1

For Electrician:  
ALL LIGHTING DEVICES REQUIRE A NEUTRAL WIRE.



General Notes

### DEVICE LEGEND

|               |                                                          |
|---------------|----------------------------------------------------------|
| <b>LKP</b>    | LUTRON WIRED LIGHTING KEYPAD                             |
| <b>\$s</b>    | WIRELESS WALL SWITCH RRD-8ANS-XX                         |
| <b>\$D</b>    | WIRELESS WALL DIMMER RRD-6NA-XX                          |
| <b>\$RFAN</b> | WIRELESS REMOTE FAN CONTROL RRD-2ANF-XX                  |
| <b>LMR</b>    | LUTRON RADIO RA2 MAIN REPEATER 2 22/2 + 18/2 TEAL TO AV1 |
| <b>LAR</b>    | LUTRON RADIO RA2 AUX. REPEATER 2 22/2 + 18/2 TEAL TO LMR |
| <b>LP#</b>    | CENTRALIZED LIGHTING PANEL PREWIRE: 2 CAT6 BLUE TO AV1   |
| <b>SPP</b>    | SHADE POWER PANEL 2 22/2 + 18/2 TO LP1                   |
|               | MOTORIZED SHADE PREWIRE: 1 LUTRON SHADE WIRE             |
| <b>AV1</b>    | MAIN RACK / AV HOME RUN LOCATION                         |

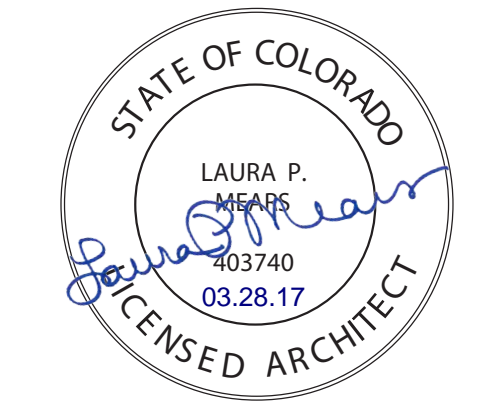

|                          |         |
|--------------------------|---------|
| AS PER DESIGNER & CLIENT | 3/21/17 |
| REVISION / DESCRIPTION   | Date    |



11320 Fortune Circle  
Suite G6  
Wellington, FL 33414  
(561)-902-1648  
PalmBeachElectronics.com

Project Name and Address  
**COLORADO RESIDENCE**

Designed by  
**Jerry Lankford**

|                             |                     |
|-----------------------------|---------------------|
| Project<br><b>COLORADO</b>  | Reviewed by         |
| Date<br><b>01-24-2017</b>   |                     |
| Scale<br><b>3/16"=1'-0"</b> | Sheet<br><b>LT2</b> |

**01 FLOORPLAN - KEYPAD**  
SCALE: 3/16" = 1'-0"

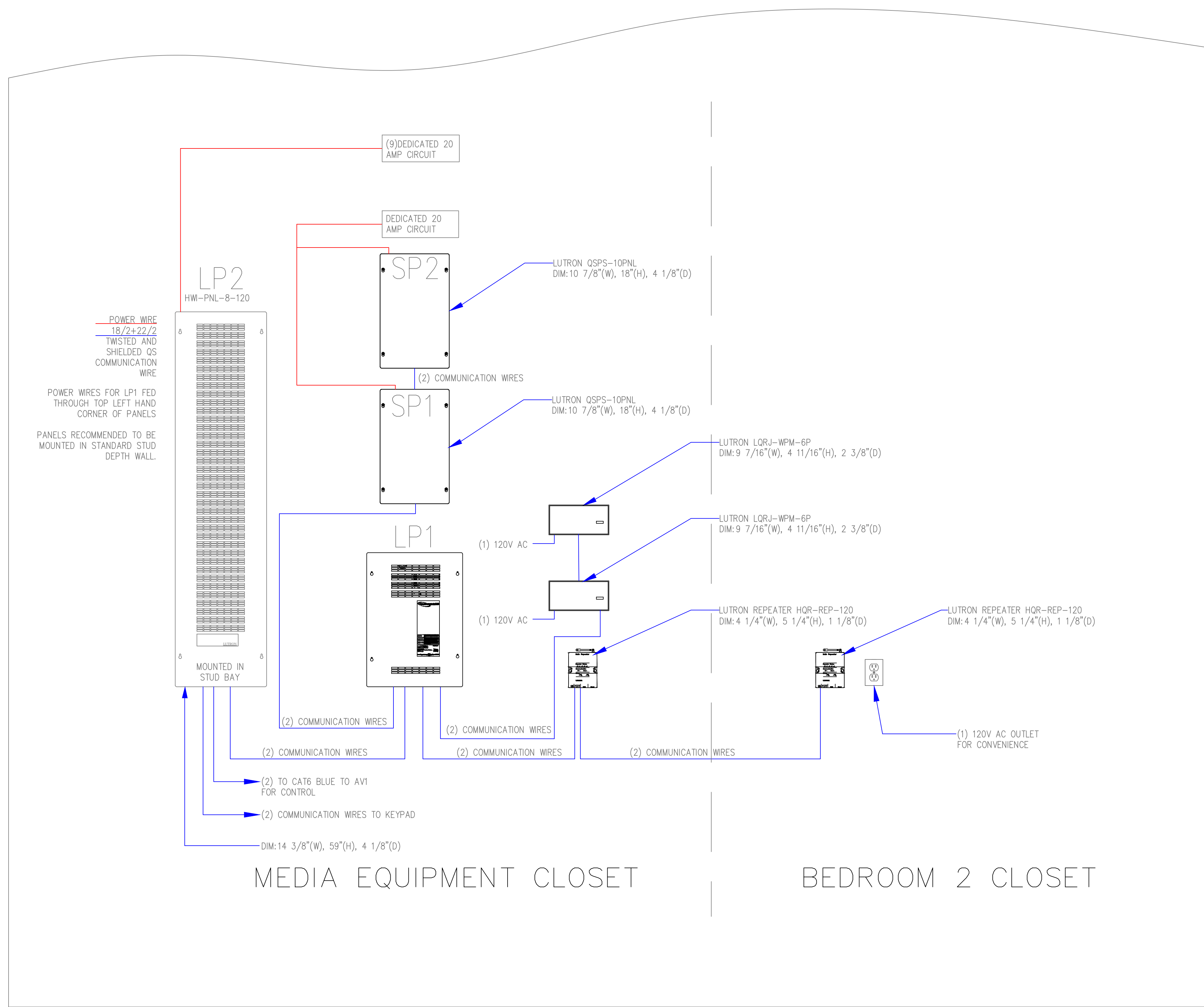

# LUTRON LIGHTING PANEL ELEVATION

SCALE: NOT TO SCALE

General Notes

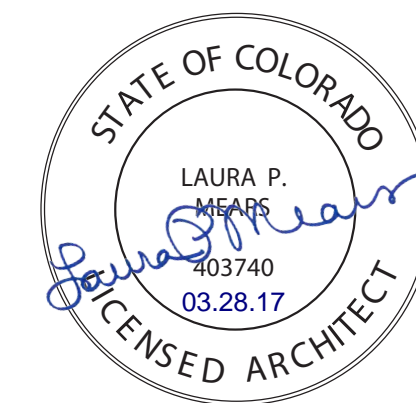

|                          |         |
|--------------------------|---------|
| AS PER DESIGNER & CLIENT | 3/21/17 |
| REVISION / DESCRIPTION   | Date    |



11320 Fortune Circle  
Suite G6  
Wellington, FL 33414  
(561)-902-1648  
PalmBeachElectronics.com

Project Name and Address

COLORADO RESIDENCE

Designed by  
**Jerry Lankford**

Project  
**COLORADO**  
Date  
**01-24-2017**

Scale  
**NOT TO SCALE**

Reviewed by  
  
Sheet  
**DTL**

**420.3 Horizontal separation.** Floor assemblies separating *dwelling units* in the same buildings, floor assemblies separating *sleeping units* in the same building and floor assemblies separating *dwelling* or *sleeping units* from other occupancies contiguous to them in the same building shall be constructed as *horizontal assemblies* in accordance with Section 711.

**510.4 Parking beneath Group R.** Where a maximum one *story above grade plane* Group S-2 parking garage, enclosed or open, or combination thereof, of Type I construction or open of Type IV construction, with grade entrance, is provided under a building of Group R, the number of *stories* to be used in determining the minimum type of construction shall be measured from the floor above such a parking area.

The floor assembly between the parking garage and the Group R above shall comply with the type of construction required for the parking garage and shall also provide a *fire-resistance rating* not less than the mixed occupancy separation required in Section 508.4.



TABLE 508.4  
REQUIRED SEPARATION OF OCCUPANCIES (HOURS)

| OCCUPANCY                 | A, E |    | I-1, I-3, I-4 |    | I-2 |    | R <sup>a</sup> |    | F-2, S-2 <sup>b</sup> , U |                | B, F-1, M, S-1 |    | H-1 |    | H-2 |    | H-3, H-4       |    | H-5 |    |
|---------------------------|------|----|---------------|----|-----|----|----------------|----|---------------------------|----------------|----------------|----|-----|----|-----|----|----------------|----|-----|----|
|                           | S    | NS | S             | NS | S   | NS | S              | NS | S                         | NS             | S              | NS | S   | NS | S   | NS | S              | NS | S   | NS |
| A, E                      | N    | N  | 1             | 2  | 2   | NP | 1              | 2  | N                         | 1              | 1              | 2  | NP  | NP | 3   | 4  | 2              | 3  | 2   | NP |
| I-1, I-3, I-4             | —    | —  | N             | N  | 2   | NP | 1              | NP | 1                         | 2              | 1              | 2  | NP  | NP | 3   | NP | 2              | NP | 2   | NP |
| I-2                       | —    | —  | —             | —  | N   | N  | 2              | NP | 2                         | NP             | 2              | NP | NP  | NP | 3   | NP | 2              | NP | 2   | NP |
| R <sup>a</sup>            | —    | —  | —             | —  | —   | —  | N              | N  | 1 <sup>c</sup>            | 2 <sup>c</sup> | 1              | 2  | NP  | NP | 3   | NP | 2              | NP | 2   | NP |
| F-2, S-2 <sup>b</sup> , U | —    | —  | —             | —  | —   | —  | —              | —  | N                         | N              | 1              | 2  | NP  | NP | 3   | 4  | 2              | 3  | 2   | NP |
| B, F-1, M, S-1            | —    | —  | —             | —  | —   | —  | —              | —  | —                         | —              | N              | N  | NP  | NP | 2   | 3  | 1              | 2  | 1   | NP |
| H-1                       | —    | —  | —             | —  | —   | —  | —              | —  | —                         | —              | —              | —  | N   | NP | NP  | NP | NP             | NP | NP  | NP |
| H-2                       | —    | —  | —             | —  | —   | —  | —              | —  | —                         | —              | —              | —  | —   | —  | N   | NP | 1              | NP | 1   | NP |
| H-3, H-4                  | —    | —  | —             | —  | —   | —  | —              | —  | —                         | —              | —              | —  | —   | —  | —   | —  | 1 <sup>d</sup> | NP | 1   | NP |
| H-5                       | —    | —  | —             | —  | —   | —  | —              | —  | —                         | —              | —              | —  | —   | —  | —   | —  | —              | —  | N   | NP |

S = Buildings equipped throughout with an automatic sprinkler system installed in accordance with Section 903.3.1.1.

NS = Buildings not equipped throughout with an automatic sprinkler system installed in accordance with Section 903.3.1.1.

N = No separation requirement.

NP = Not permitted.

a. See Section 420.

b. The required separation from areas used only for private or pleasure vehicles shall be reduced by 1 hour but to not less than 1 hour.

c. See Section 406.3.4.

d. Separation is not required between occupancies of the same classification.

## SECTION 704 FIRE-RESISTANCE RATING OF STRUCTURAL MEMBERS

**704.1 Requirements.** The *fire-resistance ratings* of structural members and assemblies shall comply with this section and the requirements for the type of construction as specified in Table 601. The *fire-resistance ratings* shall not be less than the ratings required for the fire-resistance-rated assemblies supported by the structural members.

**Exception:** *Fire barriers, fire partitions, smoke barriers and horizontal assemblies* as provided in Sections 707.5, 708.4, 709.4 and 711.4, respectively.

**704.2 Column protection.** Where columns are required to have protection to be fire-resistance rated, the entire column shall be provided individual encasement protection by protecting it on all sides for the full column length, including connections to other structural members, with materials having the required fire-resistance rating. Where the column extends through a ceiling, the encasement protection shall be continuous from the top of the foundation or floor/ceiling assembly below through the ceiling space to the top of the column.

**704.3 Protection of the primary structural frame other than columns.** Members of the primary structural frame other than columns that are required to have protection to achieve a fire-resistance rating and support more than two floors or one floor and roof, or support a load-bearing wall or a nonload-bearing wall more than two stories high, shall be provided individual encasement protection by protecting them on all sides for the full length, including connections to other structural members, with materials having the required fire-resistance rating.

**TABLE 601  
FIRE-RESISTANCE RATING REQUIREMENTS FOR BUILDING ELEMENTS (HOURS)**

| BUILDING ELEMENT                                                      | TYPE I                        |                   | TYPE II           |                | TYPE III          |   | TYPE IV             | TYPE V            |   |
|-----------------------------------------------------------------------|-------------------------------|-------------------|-------------------|----------------|-------------------|---|---------------------|-------------------|---|
|                                                                       | A                             | B                 | A <sup>d</sup>    | B              | A <sup>d</sup>    | B | HT                  | A <sup>d</sup>    | B |
| Primary structural frame <sup>e</sup> (see Section 202)               | 3 <sup>a</sup>                | 2 <sup>a</sup>    | 1                 | 0              | 1                 | 0 | HT                  | 1                 | 0 |
| Bearing walls                                                         |                               |                   |                   |                |                   |   |                     |                   |   |
| Exterior <sup>f, g</sup>                                              | 3                             | 2                 | 1                 | 0              | 2                 | 2 | 2                   | 1                 | 0 |
| Interior                                                              | 3 <sup>a</sup>                | 2 <sup>a</sup>    | 1                 | 0              | 1                 | 0 | 1/HT                | 1                 | 0 |
| Nonbearing walls and partitions                                       | See Table 602                 |                   |                   |                |                   |   |                     |                   |   |
| Exterior                                                              |                               |                   |                   |                |                   |   |                     |                   |   |
| Nonbearing walls and partitions                                       |                               |                   |                   |                |                   |   | See Section 602.4.6 |                   |   |
| Interior <sup>c</sup>                                                 | 0                             | 0                 | 0                 | 0              | 0                 | 0 |                     | 0                 | 0 |
| Floor construction and associated secondary members (see Section 202) | 2                             | 2                 | 1                 | 0              | 1                 | 0 | HT                  | 1                 | 0 |
| Roof construction and associated secondary members (see Section 202)  | 1 <sup>1/2</sup> <sup>b</sup> | 1 <sup>b, c</sup> | 1 <sup>b, c</sup> | 0 <sup>c</sup> | 1 <sup>b, c</sup> | 0 | HT                  | 1 <sup>b, c</sup> | 0 |

For SI: 1 foot = 304.8 mm.

- a. Roof supports: Fire-resistance ratings of primary structural frame and bearing walls are permitted to be reduced by 1 hour where supporting a roof only.
- b. Except in Group F-1, H, M and S-1 occupancies, fire protection of structural members shall not be required, including protection of roof framing and decking where every part of the roof construction is 20 feet or more above any floor immediately below. Fire-retardant-treated wood members shall be allowed to be used for such unprotected members.
- c. In all occupancies, heavy timber shall be allowed where a 1-hour or less fire-resistance rating is required.
- d. An approved automatic sprinkler system in accordance with Section 903.3.1.1 shall be allowed to be substituted for 1-hour fire-resistance-rated construction, provided such system is not otherwise required by other provisions of the code or used for an allowable area increase in accordance with Section 506.3 or an allowable height increase in accordance with Section 504.2. The 1-hour substitution for the fire resistance of exterior walls shall not be permitted.
- e. Not less than the fire-resistance rating required by other sections of this code.
- f. Not less than the fire-resistance rating based on fire separation distance (see Table 602).
- g. Not less than the fire-resistance rating as referenced in Section 704.10

2014 FIRE RESISTANCE DIRECTORY ISOLATEK DESIGNS

FIRE-RESISTANCE RATINGS - ANSI/UL 263 (BXUV)

**Design No. D902**

**Restrained Assembly Ratings — 1, 1-1/2, 2 and 3 Hr.**

**Unrestrained Assembly Ratings — 0, 1, 1-1/2, 2 or 3 Hr. (See Items 4 & 6)**

**Unrestrained Beam Ratings — 1, 1-1/2, 2 and 3 Hr.**

**Load Restricted for Canadian Applications — See Guide BXUV7**

**When used in Canada it is required that all materials included within the UL design are also cUL certified.**

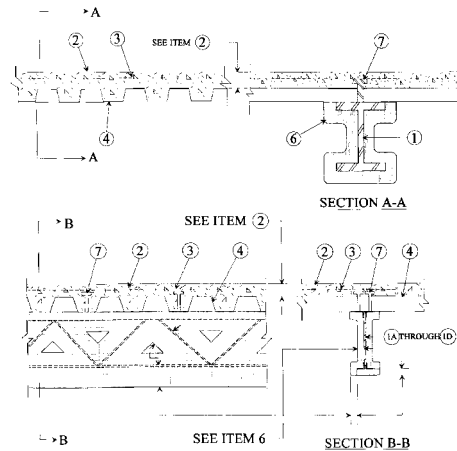

1. **Beam** — W12X14, W8X28, W8x24 or W6x12, min size, see Items 6A through 6E.
- 1A. **Steel Joists** — (Not shown) — As an alternate to Item 1 — Composite or noncomposite min 8k1 or min depth and weight shall be 8 in. and 4.9 lb/ft respectively. May be uncoated or provided with a shop coat of paint. Designed per S.J.I. specifications for a max design stress of 30, 000 psi (30 ksi). Welded or bolted to end supports. The top chords shall consist of two angles measuring 1-1/4 by 1-1/4 by 0.127 in. thick. Bottom chords shall consist of two round bars measuring 0.566 in. in diam. or two angles measuring 1 by 1 by 0.125 in. thick. Bearing plates shall consist of two angles measuring 1-1/2 by 2 by 0.188 in. thick and 5-1/16 in. long. Web members shall consist of 0.565 in. diam bars.
- 1B. **Steel Joists** — (Not shown) — As an alternate to Item 1 — Composite or noncomposite min 12k5 or min depth and weight shall be 12 in. and 7.1 lb/ft respectively. May be uncoated or provided with a shop coat of paint. Designed per S.J.I. specifications for a max design stress of 30, 000 psi (30 ksi). Welded or bolted to end supports. Top chords shall consist of two angles measuring 1-1/2 by 1-1/2 by 0.156 in. thick. Bottom chords shall consist of two round bars measuring 0.675 in. in diam. or two angles measuring 1 by 1 by 0.125 in. thick. Bearing plates shall consist of two angles measuring 2 by 2 by 0.192 in. thick and shall be min 4-15/16 in long. The second web member at each end shall consist of 0.654 in. diam round bar. All remaining web members, including the end web members, shall consist of 0.774 in. diam round bars. Bridging per S.J.I. specifications is required when noncomposite joists are used.
- 1C. **Steel Joists** — (Not shown) — As an alternate to Item 1 — Composite or noncomposite min 12k5 or min depth and weight shall be 12 in. and 7.1 lb/ft respectively. May be uncoated or provided with a shop coat of paint. Designed per S.J.I. specifications for a max design stress of 30, 000 psi (30 ksi). Welded or bolted to end supports. Top chords shall consist of two angles measuring 1-1/2 by 1-1/2 by 0.156 in. thick. Bottom chord shall consist of two round bars measuring 0.675 in. in diam. or two angles measuring 1 by 1 by 0.125 in. thick. The second web member at each end shall consist of 0.654 in. diam round bar. All remaining web members, including the end web members, shall consist of 0.774 in. diam round bars. Bridging per S.J.I. specifications is required when non-composite joists are used.
- 1D. **Steel Joists** — (Not shown) — As an alternate to Item 1 — Composite or noncomposite min 8k1 or min depth and weight shall be 8 in. and 4.9 lb/ft respectively. May be uncoated or provided with a shop coat of paint. Designed per S.J.I. specifications for a max design stress of 30, 000 psi (30 ksi). Welded or bolted to end supports. The top chords shall consist of two angles measuring 1-1/4 by 1-1/4 by 0.127 in. thick. Bottom chords shall consist of two round bars measuring 0.566 in. in diam. or two angles measuring 1 by 1 by 0.125 in. thick. Bearing plates shall conform to S.J.I. specifications. Web members shall consist of 0.565 in. diam bars.
2. **Normal Weight or Lightweight Concrete** — Normal weight concrete, carbonate or siliceous aggregate, 3500 psi compressive strength, vibrated. Lightweight concrete, expanded shale or slate aggregate by rotary-kiln method or expanded clay aggregate by rotary-kiln or sintered-grate method, 3000 psi compressive strength, vibrated, 4 to 7 per cent entrained air.

| Restrained Assembly Rating Hr | Concrete (Type) | Concrete Unit Weight pcf | Concrete Thkns In. |
|-------------------------------|-----------------|--------------------------|--------------------|
| 1                             | Normal Weight   | 147-153                  | 3-1/2              |
| 1-1/2                         | Normal Weight   | 147-153                  | 4                  |
| 2                             | Normal Weight   | 147-153                  | 4-1/2              |
| 3                             | Normal Weight   | 147-153                  | 5-1/4              |
| 1                             | Lightweight     | 107-113                  | 2-1/2              |
| 1                             | Lightweight     | 107-120                  | 2-5/8              |
| 1-1/2                         | Lightweight     | 107-113                  | 3                  |
| 2                             | Lightweight     | 107-113                  | 3-1/4              |
| 2                             | Lightweight     | 107-116                  | 3-1/4*             |
| 2                             | Lightweight     | 114-120                  | 3-1/2              |
| 3                             | Lightweight     | 107-113                  | 4-3/16             |
| 3                             | Lightweight     | 114-120                  | 4-7/16             |

\*With 2 and 3 in. deep steel floor units only.

3. **Welded Wire Fabric** — 6x6 10/10 SWG.
- 3A. **Negative Reinforcement** — (Not Shown) - Optional - Used in lieu of Item 3 and with Items 3B or 3C. For floor spans with concrete cast continuous over the supporting beams. Deformed bars designed to resist the support moments of the concrete slab in accordance with the latest ACI Building Code Specifications.
- 3B. **Fiber Reinforcement\*** — (Not Shown) - Required with Item 3A. Engineered synthetic fibers added to concrete mix to control shrinkage cracks in concrete. Fibers added to concrete mix at rate of 1 lb of fiber for each cubic yard of concrete.  
**PROPEX OPERATING COMPANY L L C** —Fibermesh 150 and Fibermesh 300.
- 3C. **Fiber Reinforcement\*** — (Not Shown) - Required with Item 3A. Any fiber reinforcement bearing the UL Classification Marking for Fire Resistance, Classified for use in lieu of welded wire fabric.  
 See **Fiber Reinforcement (CBXQ)** Category for names of manufacturers.
4. **Steel Floor and Form Units\*** — Composite 1-1/2, 1-5/8, 2 or 3 in. deep galv units or 4-1/2 in. deep non-composite galv units.

Fluted units may be phos/ptd. Min gauges are 22 MSG for fluted and 20/20 for cellular and partial cellular units. The following combinations of units may be used:

- (1) All 24, 26, 28 or 36 in. wide cellular or partial cellular.
- (2) All fluted.
- (3) One or two 3 in. deep, 12 in. wide, 18/18 MSG min cellular alternating with 3 in. deep fluted or other cellular.
- (4) Any blend of fluted and 24, 26, 28 or 36 in. wide cellular or partial cellular.
- (5) Corrugated, nom 1-5/16 or 2 in. deep, 30 in. wide, 24 MSG min galv units with shear wires factory welded to deck corrugations. Welded to supports 12 in. OC through welding washers. For shear wire spacing of 8 in. or less the steel deck stress shall not exceed 20 KSI. For shear wire spacing greater than 8 in. OC but less than or equal to 12 in. OC steel deck stress shall not exceed 12 KSI.

#### ASC STEEL DECK, DIV OF ASC PROFILES L

**L C**—36 in. wide, Types BH-36, BHN-36, BHN-35-1/4, BHF-36, BHF-36A, NH-32, NHN-32, NHF-32, 2WH-36, 2WHS-36, 2WHF-36, 2WHF-36A, 3WH-36, 3WHF-36, 3WHF-36A. All units may be galvanized or Prime Shield. Non-cellular decks may be vented designated with a "V" suffix to the product name.

**CANAM STEEL CORP**—24 in. wide Type P-2432 composite or 36 in. wide Type P-3623, P-3606, P-3615 and 24 in wide Type P-2432 composite, Type P-3606 and P-3615 non-composite

**CANAM STEEL CORP**—12 or 24 in. wide, Types 1-1/2, 2, or 3 in. LOK-Floor and LOK-Floor Cell; 36 in. wide, Types 2 or 3 in. LOK-Floor and LOK-Floor Cell; 24, 30 or 36 in. wide, Type 1-1/2 in. B-LOK and B-LOK Cell; 24 in. wide, Types N-LOK and N-LOK Cell.

**CENTRIA**—QL Types, 24 in. wide, 3 or 3 inverted, UKX, 21 or 21 inverted, 2 in. 99, 121, AKX, NKX, TKX; 24 or 30 in. wide GKX, GKXH, GKX-A; 36 in. wide 2 in. 99, AKX, WKX; 12 in. wide NKC, TKC; 12 in. wide non-composite Sec 12. Side joints of 99, 121, TKC, TKX, WKX may be welded together 60 in. OC. Side joints of 99, AKX, WKX, GKX, GKX-A, TKX may be fastened together with min 1 in. long No. 12x14 self-drilling, self-tapping steel screws 36 in. OC.

**CHIA TEH CONSTRUCTION MATERIAL CO LTD**—24 or 36 in. wide Mac-Lok 3; 24 in. wide CFD-3.

**CONSOLIDATED SYSTEMS INC**—24 in. wide Types CFD-2, CFD-3; 24, 30 or 36 in. wide Type CFD-1.5; 24 or 36 in. wide Types Mac-Lok 2, Mac-Lok 3; 24 in. wide Types B2C, B2FC, NC, NFC; 30 in. wide, Type B3C; 12 in. wide Mac-Way Cellular 45 MDW, 2-633 MTWA, 3-633 MTWA+. 30 in. wide, Mac-Cor Types 1 and 2

**DECK WEST INC**—36 in. wide Type B-DW, Inverted B-DW, BA-DW, Inverted BA-DW, 2-DW or 3-DW. Side joints of Type 2-DW and 3-DW may be fastened together with min 1 in. long No. 12 x 14 self-drilling, self-tapping steel screws 36 in. OC.

#### DESIGN ASSISTANCE CONSTRUCTION

**SYSTEMS INC**—36 in. wide Type DACS1.5CD, or 24 in. wide Type DACS2.0CD, or DACS3.0CD.

**EPIC METALS CORP**—24 in. wide Types EC150, EC150 inverted, EC300, EC366, ECP150, ECP300, ECP366, ECA; 30 in. wide Types ECB150, ECBR150; 36 in. wide Types EC156, EC266, ECP266.

**GENS METALS INC**—12 or 24 in. wide Types LF2, LF3.

**KAM INDUSTRIES LTD, DBA CORDECK**—24 in. wide, Types 2 or 3 in. WDR.

**MARLYN STEEL DECKS INC**—Type 1.5 CF, 2.0 CF or 3.0 CF.

**MORIN CORP**—24, 30 or 36 in. wide Types LXR-B, LXR-B inverted; 24 or 36 in. wide Type LXR-3W; 36 in. wide Type LXR-2W.

**NEW MILLENNIUM BUILDING SYSTEMS L L C**—Type 1.5CD, 1.5CDI, 1.5CDR, 2.0CD, or 3.0CD. Units may be phos/painted or galvanized.

**ROOF DECK INC**—36 in. wide Types LOK-1-1/2, LOK-1-1/2R; 24 in. wide Types LOK-2, LOK-3.

**VALLEY JOIST**—24 or 36 in. wide Types WVC 1-1/2 or WVC 2.

**VERCO DECKING INC - A NUCOR CO**—24, 30 or 36 in. wide Types PLB, PLBCD, B, BCD, BR; 24 or 36 in. wide Types PLW2, PLW2CD, W2, W2CD, PLW3, PLW3CD, W3, W3CD; 24 in. wide Types PLN, PLNCD, N, NCD. 12 in. wide PLW2, W2, PLW3 or W3 units may be blended with 24 or 36 in. wide PLW2, W2, PLW3 or W3 units, respectively; or Types PLN3-CD, N3-CD, PLN3, N3. Fluted units may be phos/ptd.

**VULCRAFT, DIV OF NUCOR CORP**—24, 30 or 36 in. wide, Type 1.5 VL, 1.5VLI, 1.5VLP; 24 or 36 in. wide, Types 1.5VLPA, 2VLI, 3VLI, 2VLP, 3VLP, 2VLP, 3VLP, 2VLP, 3VLP. 36 in. wide Types 1.5 SB, 1.5 SBR; 24 or 36 in wide Types 2.0 SB, 3.0 SB, 36 in. wide Type High Strength 1.5 SBI, 36 in. wide Type High Strength 1.5 SBN; Units may be phos/ptd.

Spacing of welds attaching units to supports shall be 12 in. OC for 12, 24, 36 in. wide units, four welds per sheet for 30 in. wide units. 6 in. OC for 18 in. wide and Sec. 12 units. Unless specified otherwise for specific units types, adjacent units button-punched or welded together 36 in. OC along side joints. For **3 Hr Rating**, units with overlapping type side joints welded together 24 in. OC max.

When a superimposed load of 250 PSF is desired the spacing of welds or button-punches shall not exceed 24 in. OC along side joints.

+12 in. wide, 1-1/2 in. deep Mac-Way units may be blended with 24 in. wide B2C or 30 in wide B3C units in a blend of one cell to one or more fluted units. 12 in. wide, 2 in. deep Mac-Way units may be blended with 24 or 36 in. wide Mac-Lock units in a blend of one cell to one or more fluted units. 12 in. wide, 3 in. deep Mac-Way units may be blended with 24 or 36 in. wide Mac-Lock 3 units in a blend of one cell to one or more fluted units. The side edge of the fluted units is placed on the top of the side edge of the Mac-Way unit and the two are welded together with welding washers spaced a max. of 32 in. OC for Mac-Lock 2 or 3 units and a max of 24 in. OC for the B2C or B3C units.

Alternate Construction — Noncomposite units of the same type listed above may be used provided allowable loading is calculated on the basis of noncomposite design.

The Unrestrained Assembly Rating is equal to the Unrestrained Beam Rating (See Item 6) for a max 3 Hr and is limited to the following units and limitations:

- (a) 1-1/2, 2 and 3 in. deep, 24 in. wide, 22 MSG or thicker fluted with clear spans not more than 7 ft, 8 in.
- (b) 1-1/2, 2 and 3 in. deep, 24 in. wide, 20 MSG or thicker fluted with clear spans not more than 8 ft, 8 in.
- (c) 1-1/2 and 2 in. deep, 24 in. wide, 16 MSG or thicker fluted and 18/18 MSG or thicker cellular with clear spans not more than 9 ft, 11 in.
- (d) 3 in. deep, 36 in. wide, 18 MSG or thicker fluted and 24 in. wide, 20/18 MSG or thicker cellular with clear spans not more than 13 ft, 2 in.

For assemblies utilizing 3-1/4 in. lightweight concrete topping with a max Restrained Assembly Rating of 2 Hr, the Unrestrained Assembly Rating is equal to the Unrestrained Beam Rating (See Item 6) and is limited to the following floor units and spans:

- (a) 1-1/2, 2 and 3 in. deep, 24 or 36 in. wide, 22 MSG fluted and 20/20 MSG cellular with clear spans not more than 9 ft, 6 in.
- (b) 2 and 3 in. deep, 24 or 36 in. wide, 20 MSG fluted and 20/20 MSG cellular with clear spans not more than 10 ft, 0 in.
- (c) 3 in. deep, 24 in. wide, 20 MSG fluted and 20/20 MSG cellular with clear spans not more than 13 ft, 2 in.

5. **Joint Cover**— (Use with fluted units optional — Not Shown) — 2 in. wide cloth adhesive tape applied following the contour of the units.

6. **Spray-Applied Fire Resistive Materials\***— Applied by spraying with water, in one coat to a final thickness as shown above and in table below to steel beam surface which is free of dirt, oil or scale. When fluted steel deck is used and the fire protection thickness selected is based on all fluted deck, the area between the steel deck and the top flange of the steel beam shall be filled. When fluted steel deck is used and the steel beam is sprayed with the thicknesses applicable to cellular or blended units, the area between the steel deck and the top flange of the steel beam shall be plugged. Use of adhesive is optional. Min avg untamped density is 13 pcf with min ind untamped density of 11 pcf for Types II or DC/F. Min avg and min ind untamped densities of 22 and 19 pcf, respec-

tively, for Type HP. Tamping is optional. For method of density determination, refer to Design Information Section. The thickness of the Spray-Applied Fire Resistive Materials on the Structural Members (Item 1, 1A, or 1B) shall be as follows:

| Restrained Assembly Rating Hr | Unrestrained Beam Rating Hr | Concrete Type | Protection Mtl Thkns on Structural Member In. |                                          |                           |                                                     |                                                     |
|-------------------------------|-----------------------------|---------------|-----------------------------------------------|------------------------------------------|---------------------------|-----------------------------------------------------|-----------------------------------------------------|
|                               |                             |               | W8x28 When Deck Is All Fluted                 | W8x28 When Deck Is Blend or All Cellular | W12x14 Deck Is All Fluted | Joist Item 1A When Deck Is Fluted Cellular or Blend | Joist Item 1B When Deck Is Fluted Cellular or Blend |
| 1                             | 1                           | NW            | 3/8,5/8**                                     | 1/2+,11/16**                             | 9/16,15/16**              | 1++                                                 | —                                                   |
| 1-1/2                         | 1                           | NW            | 3/8,5/8**                                     | 1/2+,11/16**                             | 9/16,15/16**              | 1-9/16                                              | —                                                   |
| 2                             | 1                           | NW            | 3/8,5/8**                                     | 1/2+,11/16**                             | 9/16,15/16**              | 2-1/16                                              | —                                                   |
| 2                             | 2                           | NW            | 3/4                                           | 1-3/8+                                   | 1-1/16                    | 2-1/16                                              | —                                                   |
| 2                             | 3                           | NW            | 1-3/16                                        | 2-1/8+                                   | 1-11/16                   | —                                                   | 3-1/4                                               |
| 3                             | 1-1/2                       | NW            | 1/2                                           | 7/8*                                     | 3/4                       | —                                                   | 3-1/4                                               |
| 3                             | 2                           | NW            | 3/4                                           | 1-3/8+                                   | 1-1/16                    | —                                                   | 3-1/4                                               |
| 3                             | 3                           | NW            | 1-3/16                                        | 2-1/8+                                   | 1-11/16                   | —                                                   | 3-1/4                                               |
| 1                             | 1                           | LW            | 3/8,5/8**                                     | 1/2+,11/16**                             | 9/16,15/16**              | 1-1/8++                                             | —                                                   |
| 1-1/2                         | 1                           | LW            | 3/8,5/8**                                     | 1/2+,11/16**                             | 9/16,15/16**              | 1-3/4                                               | —                                                   |
| 2                             | 1                           | LW            | 3/8,5/8**                                     | 1/2+,11/16**                             | 9/16,15/16**              | 2-1/4                                               | —                                                   |
| 2                             | 2                           | LW            | 1                                             | 1-3/8+                                   | 1-7/16                    | 2-1/4                                               | —                                                   |
| 2                             | 3                           | LW            | 1-9/16+                                       | 2-1/8+                                   | 2-1/4                     | —                                                   | 3-1/4                                               |
| 3                             | 1-1/2                       | LW            | 11/16                                         | 7/8*                                     | 1                         | —                                                   | 3-1/4                                               |
| 3                             | 2                           | LW            | 1+                                            | 1-3/8+                                   | 1-7/16                    | —                                                   | 3-1/4                                               |

\*May be reduced to 3/4 in. for the 1-1/2 hr Unrestrained Beam Rating when the material is sprayed 2 in. beyond the beams's top flange and no reduction in thickness is made at the tips of the bottom flange.

\*\*This thickness applies when optional Item 12 or 13 are used over 3-1/4 in. lightweight concrete topping.

+Thickness of Spray-Applied Fire Resistive Materials may be reduced to one half of this thickness on the lower flange tips of the steel beam. ++ - When bottom chords consist of 1 by 1 by 0.125 in. thick steel angles, the thickness of spray-applied fire resistive material shall be increased by 1/4 in. on the bottom chord only.

ISOLATEK INTERNATIONAL —Type D-C/F, HP, Type II, Type EBS or Type X adhesive which may also be used as a surface sealer.

6A. **Spray-Applied Fire Resistive Materials\*** — Alternate to Item 6. See table below for appropriate thicknesses. When fluted steel deck is used and the fire protection thickness selected is based on all fluted deck, the area between the steel deck and the top flange of the steel beam shall be filled. When fluted steel deck is used and the steel beam is sprayed with the thicknesses applicable to cellular or blended units, the area between the steel deck and the top flange of the steel beam shall be plugged. Prepared by mixing with water and spray-applied in one or more coats to beam surfaces which must be clean and free of dirt, loose scale and oil. Min average density of 17.5 pcf with min individual value of 17.0 pcf. For method of density determination, see Design Information Section, Sprayed Material.

| Restrained Assembly Rating Hr | Unrestrained Beam Rating Hr | Protection Thkns on W8x28, In. |                                    |
|-------------------------------|-----------------------------|--------------------------------|------------------------------------|
|                               |                             | When Deck Is All Fluted        | When Deck Is Blend or All Cellular |
| 1, 1-1/2, 2                   | 1                           | 5/16, 7/16*                    | 5/16, 7/16*                        |
| 2                             | 2                           | 11/16                          | 13/16                              |
| 2                             | 3                           | 1-1/16                         | 1-5/16                             |
| 3                             | 1-1/2                       | 1/2                            | 9/16                               |
| 3                             | 2                           | 11/16                          | 13/16                              |
| 3                             | 3                           | 1-1/16                         | 1-5/16                             |

\*This thickness applies when optional Items 12, 13 are used over 3-1/4 in. lightweight concrete topping.

+ ++ - When bottom chords consist of 1 by 1 by 0.125 in. thick steel angles, the thickness of spray-applied fire resistive material shall be increased by 1/4 in. on the bottom chord only.

ISOLATEK INTERNATIONAL —Type 280.

6B. **Spray-Applied Fire Resistive Materials\*** — Alternate to Item 6 or 6A. Applied by mixing with water according to instructions on each bag of material. Mixture can be spray or trowel applied in one or more coats. The thickness of the mixture is dependent on the type of floor unit. See table below for appropriate thickness. When fluted steel deck is used and the fire protection thickness selected is based on all fluted deck, the area between the steel deck and the top flange of the steel beam shall be filled. When fluted steel deck is used and the steel beam is sprayed with the thicknesses applicable to cellular or blended units, the area between the steel deck and the top flange of the steel beam shall be plugged. The steel surfaces must be clean and free of dirt, loose scale and oil. Minimum average density of 38 pcf and minimum individual density of 35 pcf for Type 800. Min avg density of 44 pcf with min ind value of 40 pcf for Type M-II. Min avg density of 44 pcf with min ind value of 42 pcf for Type TG. For method of density determination, refer to Design Information Section, Sprayed Material.

| Restrained Assembly Rating Hr | Unrestrained Beam Rating Hr | Protection Thkns on W8x28, In. |                                    |
|-------------------------------|-----------------------------|--------------------------------|------------------------------------|
|                               |                             | When Deck Is All Fluted        | When Deck Is Blend or All Cellular |
| 1, 1-1/2, 2                   | 1                           | 3/8, 1/2*                      | 7/16, 9/16*                        |
| 2                             | 2                           | 15/16                          | 1-1/4                              |
| 2                             | 3                           | 1-5/16                         | 1-1/2                              |
| 3                             | 1-1/2                       | 5/8                            | 1                                  |
| 3                             | 2                           | 15/16                          | 1-1/4                              |
| 3                             | 3                           | 1-5/16                         | 1-1/2                              |

\*This thickness applies when optional Item 12 or 13 are used over 3-1/4 in. lightweight concrete topping.

BERLIN CO LTD —Types M-II or TG. Types M-II and TG Investigated for exterior use.

ISOLATEK INTERNATIONAL — Types 800, M-II or TG. Types 800, M-II and TG Investigated for exterior use.

NEWKEM PRODUCTS CORP —Types M-II or TG. Types M-II and TG Investigated for exterior use.

6C. **Spray-Applied Fire Resistive Materials\*** — Alternate to Items 6A or 6B. Applied by mixing with water in accordance with instructions on each bag and applied in one or more coats to a final thickness as shown in table below to steel beam surface which is free of dirt, oil or scale. When fluted steel deck is used and the fire protection thickness selected is based on all fluted deck, the area between the steel deck and the top flange of the steel beam shall be filled. When fluted steel deck is used and the steel beam is



2014 FIRE RESISTANCE DIRECTORY ISOLATEK DESIGNS

sprayed with the thicknesses applicable to cellular or blended units, the area between the steel deck and the top flange of the steel beam shall be plugged.

Min average and min individual density is 15 and 14 pcf, respectively, for Types 300, 300ES, 300HS, 300N, 3000, 3000ES and SB. For Types 400AC and 400ES min average and min individual density of 22 and 19 pcf, respectively. For method of density determination, refer to Design Information Section. The thickness of the material on the Structural Members (Item 1, 1C, or 1D) shall be as follows:

| Restrained Assembly Rating Hr | Unrestrained Beam Rating Hr | Protection Mtl Thkns on Structural Members In. |                                          |                                | Joist (Item 1C or 1D) When Deck Is Fluted Cellular or Blend |
|-------------------------------|-----------------------------|------------------------------------------------|------------------------------------------|--------------------------------|-------------------------------------------------------------|
|                               |                             | W8x28 When Deck Is All Fluted                  | W8x28 When Deck Is Blend or All Cellular | W12x14 When Deck Is All Fluted |                                                             |
| 1                             | 1                           | 5/16, 7/16*                                    | 5/16, 7/16*                              | 1/2.5/8*                       | 9/16                                                        |
| 1-1/2                         | 1                           | 5/16, 7/16*                                    | 5/16, 7/16*                              | 1/2.5/8*                       | 1                                                           |
| 2                             | 1                           | 5/16, 7/16*                                    | 5/16, 7/16*                              | 1/2.5/8*                       | 1-3/8                                                       |
| 2                             | 2                           | 11/16                                          | 13/16                                    | 1                              | 1-3/8                                                       |
| 2                             | 3                           | 1-1/16                                         | 1-5/16                                   | 1-1/2                          | 2-1/4                                                       |
| 3                             | 1-1/2                       | 1/2                                            | 9/16                                     | 3/4                            | 2-1/4                                                       |
| 3                             | 2                           | 11/16                                          | 13/16                                    | 1                              | 2-1/4                                                       |
| 3                             | 3                           | 1-1/16                                         | 1-5/16                                   | 1-1/2                          | 2-1/4                                                       |

\*This thickness applies when optional Item 12 or 13 are used over 3-1/4 in. lightweight concrete topping.

BERLIN CO LTD —Type 300, Type 300ES, Type 300N or Type SB.

ISOLATEK INTERNATIONAL —Type 300, Type 300AC, Type 300ES, Type 300HS, Type 300N, Type SB, Type 400AC, Type 400ES, Type 3000 or Type 3000ES.

NEWKEM PRODUCTS CORP —Type 300, Type 300ES, Type 300N, or Type SB.

6D. **Spray-Applied Fire Resistive Materials\*** — Alternate to Items 6A, 6B or 6C. Applied by mixing with water in accordance with instructions on each bag and applied in one or more coats to a final thickness as shown in table below to steel beam surface which is free of dirt, oil or scale. When fluted steel deck is used and the fire protection thickness selected is based on all fluted deck, the area between the steel deck and the top flange of the steel beam shall be filled. When fluted steel deck is used and the steel beam is sprayed with the thicknesses applicable to cellular or blended units, the area between the steel deck and the top flange of the steel beam shall be plugged.

Min average and min individual density is 17.5 and 16 pcf, respectively, for 300TW. Min average and min individual density of 22 and 19 pcf, respectively, for Type 400. For method of density determination, refer to Design Information Section. The thickness of the material on the Structural Members (Item 1, 1C, or 1D) shall be as follows:

| Restrained Assembly Rating Hr | Unrestrained Beam Rating Hr | Protection Mtl Thkns on Structural Members In. |                                          |                                | Joist (Item 1C or 1D) When Deck Is Fluted Cellular or Blend |
|-------------------------------|-----------------------------|------------------------------------------------|------------------------------------------|--------------------------------|-------------------------------------------------------------|
|                               |                             | W8x28 When Deck Is All Fluted                  | W8x28 When Deck Is Blend or All Cellular | W12x14 When Deck Is All Fluted |                                                             |
| 1                             | 1                           | 5/16, 7/16*                                    | 5/16, 7/16*                              | 1/2.5/8*                       | 9/16                                                        |
| 1-1/2                         | 1                           | 5/16, 7/16*                                    | 5/16, 7/16*                              | 1/2.5/8*                       | 1                                                           |
| 2                             | 1                           | 5/16, 7/16*                                    | 5/16, 7/16*                              | 1/2.5/8*                       | 1-3/8                                                       |
| 2                             | 2                           | 11/16                                          | 13/16                                    | 1                              | 1-3/8                                                       |
| 2                             | 3                           | 1-1/16                                         | 1-5/16                                   | 1-1/2                          | 2-1/4                                                       |
| 3                             | 1-1/2                       | 1/2                                            | 9/16                                     | 3/4                            | 2-1/4                                                       |
| 3                             | 2                           | 11/16                                          | 13/16                                    | 1                              | 2-1/4                                                       |
| 3                             | 3                           | 1-1/16                                         | 1-5/16                                   | 1-1/2                          | 2-1/4                                                       |

\*This thickness applies when optional Item 12 or 13 are used over 3-1/4 in. lightweight concrete topping.

BERLIN CO LTD —Type 400.

ISOLATEK INTERNATIONAL — Type 300TW, Type 400.

NEWKEM PRODUCTS CORP —Type 400.

6E. **Mastic and Intumescent Coatings\*** — As an alternate to Items 6 through 6D. For use with fluted steel floor and form units only. Min. size W8x24 or W6x12 beams shall be primed with a phenolic modified alkyd primer, a metal alkyd primer, an acrylic primer or an epoxy primer at a nominal thickness of 2 mil. Coating spray or brush applied in accordance with the manufacturer's instructions at the min dry thickness as shown in the table below. The thickness shown below includes the primer thickness. Flutes above beam to be completely filled with minimum 6 pcf mineral wool insulation, or the top flange of the beam to be protected with the same thickness of coating as required on the beam.

| Minimum Dry Thickness mils | Minimum Dry Thickness mm | Beam Size | Unrestrained Beam Rating Hr | Restrained Assembly Rating Hr |
|----------------------------|--------------------------|-----------|-----------------------------|-------------------------------|
| 53                         | 1.34                     | W8x24     | 1                           | 2                             |
| 95                         | 2.41                     | W8x24     | 1-1/2                       | 3                             |
| 73                         | 1.83                     | W6x12     | 1                           | 2                             |
| 123                        | 3.10                     | W6x12     | 1-1/2                       | 3                             |

BERLIN CO LTD —Type WB 3. Investigated for Interior General Purpose. Type WB 4, Investigated for Interior General Purpose. Type WB4, Investigated for Exterior Use with top coat as described in Item 6F.

ISOLATEK INTERNATIONAL —Type SprayFilm-WB 3 and Type WB 3. Investigated for Interior General Purpose. Type SprayFilm-WB 4 and Type WB 4, Investigated for Exterior Use with top coat as described in Item 6F.

6F. **Mastic and Intumescent Coatings\*** — As an alternate to Items 6 through 6E. For use with normal weight concrete. Min. size W8x28 beams shall be primed with a phenolic modified alkyd primer a metal alkyd primer, an acrylic primer or an epoxy primer at a nominal thickness of 2 mil. Coating spray or brush applied in accordance with the manufacturer's instructions at the min dry thickness as shown in the table below. The thickness shown below includes the primer thickness. The top surface of the top flange where fluted units are used must be protected with the coating material at the same min dry thickness at a min distance of 1 in. (25 mm) inward from the flange tip on both sides of the beam. Mineral wool insulation optional above top surface of the beam.

| Minimum Dry Thickness mils | Minimum Dry Thickness mm | Steel Floor Units  | Unrestrained Beam Rating Hr | Restrained Assembly Rating Hr |
|----------------------------|--------------------------|--------------------|-----------------------------|-------------------------------|
| 103                        | 2.62                     | Fluted or Cellular | 1-1/2                       | 2                             |
| 179                        | 4.55                     | Cellular           | 1-1/2                       | 3                             |
| 341                        | 8.67                     | Cellular           | 2                           | 3                             |

**BERLIN CO LTD** — Type WB 3. Investigated for Interior General Purpose. Type WB 4, Investigated for Interior General Purpose. Type WB 4, Investigated for Exterior Use with top coat as described in Item 6G.

**ISOLATEK INTERNATIONAL** — Type SprayFilm-WB 3 and Type WB 3. Investigated for Interior General Purpose. Type SprayFilm-WB 4 and Type WB 4, Investigated for Interior General Purpose. Type SprayFilm-WB 4 and Type WB 4, Investigated for Exterior Use with top coat as described in Item 6G.

- 6G. **Top Coat** — Type SprayFilm - TOPSEAL and Type TOPSEAL required for Exterior Use, applied at a minimum dry thickness of 14 mils (0.34 mm) over the intumescent material. See Classification information in the Mastic and Intumescent Coating (CDWZ) category, Isolatek International, for mixing requirements.
- 6H. **Mastic and Intumescent Coatings\*** — As an alternate to Items 6 through 6F. For use with normal weight or light weight concrete and fluted steel floor and form units only. Min size W8x24 beams shall be primed with a phenolic modified alkyd primer at a thickness of 2 mils or a epoxy primer at a nominal thickness of 1 mil. Coating spray or brush applied in accordance with the manufacturer's instructions at the thicknesses shown below. The thickness includes the thickness of primer. The top surface of the top flange where fluted units are used must be protected with the coating material at the same min dry thickness or filled with nominal 4 pcf mineral wool.
7. **Shear Connector Studs** — Optional — Studs, 3/4 in. diam by 3 in. long, for 1-1/2 in. deep form units to 5-1/4 in. long for 3 in. deep form units, headed type or equivalent per AISC specifications. Welded to the top flange of the beam through the steel form units.
8. **Lath Hanger** — (Not Shown) — Optional - For use in caged beams with Items 6, 6A, 6B or 6C Galv steel 6 SWG min diam spaced 27 in. O. C.
9. **Clips** — (Not Shown) — Optional - For use in caged beams with Items 6, 6A, 6B or 6C No. 24 MSG spring steel pushed on to top and bottom flanges of beam spaced 6 in. O. C. max.
10. **Metal Lath** — (Not Shown) — Optional - For use in caged beams with Items 6, 6A, 6B or 6C 3/8 in. diamond mesh or rib lath, 3.4 lbs per sq yd expanded steel attached to beam with clips spaced 6 in. OC max; or tied to lath hangers with 18 SWG galv steel wire spaced 6 in. OC max.
11. **Electrical Inserts** — (Not Shown) — Classified as "Outlet Boxes and Fittings Classified for Fire Resistance" .\*
12. **Mineral and Fiberboards\*** — (Optional, not shown). Applied over concrete floor with no restriction on board thickness. When mineral and fiber boards are used, the unrestrained beam rating shall be increased by a minimum of 1/2 hr. See **Mineral and Fiber Board** (CERZ) category for names of manufacturers.
13. **Foamed Plastic\*** — (Optional, not shown). Consisting of polyisocyanurate or urethane roof insulations. Applied over concrete floor with no restrictions on thickness. When polyisocyanurate or urethane insulation is used, the unrestrained beam rating shall be increased by a minimum of 1/2 hr. See **Foamed Plastic** (CCVW) for list of manufacturers.
14. **Insulating Concrete** — (Optional, not shown) — Various types of insulating concrete prepared and applied as follows:  
 A. Vermiculite Concrete - Blend 6 to 8 cu ft of Vermiculite Aggregate\* to 94 lb Portland cement and air entraining agent. Min thickness of 2 in. as measured to the top surface of the structural concrete or foamed plastic (Item 15) when it is used. See Vermiculite Aggregate (CJZZ) category for names of Classified companies.  
 B. Cellular Concrete-Roof Topping Mixture\* - Concentrate mixed with water and Portland cement per manufacturer's specifications. Min. thickness of 2-in. as measured to the top surface of the structural concrete or foamed plastic (Item 15 and 15A) when used. Cast dry density and 28-day min compressive strength of 190 psi as determined with ASTM C495-66.  
**CELCORE INC** — Type Celcore with cast dry density of 31 (+ or - 3.0) pcf or Type Celcore MF with cast dry density of 29 (+ or - 3.0) pcf.  
**AERIX INDUSTRIES** — Cast dry density of 37 (+ or -) 3.0 pcf.  
**ELASTIZELL CORP OF AMERICA** — Type II, with a cast dry density of 39 (+ or - 3.0) pcf.  
**LITE-CRETE INC** — Cast density of 29 (+ or -) 3.0 pcf.  
**SIPLAST INC** — Mix #1, Cast dry density of 32 (+ or -) 3 pcf.  
**SIPLAST INC** — Mix #2, Cast dry density of 36 (+ or -) 3 pcf.  
 C. Cellular Concrete-Roof Topping Mixture\* - Foam concentrate mixed with water, Portland cement and UL Classified Vermiculite Aggregate per manufacture's application instructions. Cast dry density of 33 (+ or -) 3 pcf and 28 day compressive strength of min 250 psi as determined in accordance with ASTM C495-86.  
**AERIX INDUSTRIES** — Mix #3.  
**ELASTIZELL CORP OF AMERICA** — Type II. Mix #1 of cast dry density 39 (+ or -) 3.0 pcf, Mix #2 of cast dry density 40 (+ or -) 3.0 pcf, Mix #3 of cast dry density 47 (+ or -) 3.0 pcf.  
**SIPLAST INC** — Mix #3.  
 D. Perlite Concrete - 6 cu ft of Perlite Aggregate\* to 94 lb of Portland Cement and 1-1/2 pt air entraining agent. Min thickness 2 in. as measured to the top surface of structural concrete or foamed plastic (Item 15A) when it is used.  
 See Perlite Aggregate (CFFX) in Fire Resistance Directory for names of Classified companies.
15. **Foamed Plastic\*** — (Optional-not shown) — For use only with vermiculite (Item 14A) or cellular (Item 14B) concretes-Rigid polystyrene foamed plastic insulation having slots and/or holes sandwiched between vermiculite concrete slurry which is applied to the normal or lightweight concrete surface and vermiculite concrete topping (Item 14A).  
 See Foamed Plastic\* (BRYX) category in Building Materials Directory or Foamed Plastic\* (CCVW) Category in Fire Resistance Directory for list of Classified companies.
- 15A. **Foamed Plastic\*** — (Not Shown) — For use only with cellular or perlite concrete. Nominal 24 by 48 in. polystyrene foamed plastic insulation boards having a density of 1.0 (+ or - 0.1) pcf, encapsulated within concrete topping. Each insulation board shall contain six nominal 3 in. diameter holes oriented in two rows of three holes each with the holes spaced 12 in. OC transversely and 16 in. OC longitudinally.  
 See Foamed Plastic\* (BRYX) category in Building Materials Directory or Foamed Plastic\* (CCYW) category in Fire Resistance Directory for list of Classified companies.
16. **Roof Covering Materials\*** — (Optional, not shown) — Consisting of materials compatible with insulations described herein which provide Class A, B or C coverings. See Built-Up Roof Covering Materials in Building Materials Directory.
17. **Insulated Concrete** — (Optional, not shown) — various types of insulated concrete prepared and applied in the thickness indicated.  
 A. **Vermiculite Concrete** — Mix consists of 6 cu ft of Vermiculite Aggregate\*, 94 lbs of Portland cement and 6 ox of air entraining agent. Thickness to be 2 in min from the top plane of steel roof deck.  
**ELASTIZELL CORP OF AMERICA** — Types MS16-U, MSV 200.  
 B. **Perlite Concrete** — Mix consists of 6.2 cu ft Perlite Aggregate\* to 94 lbs of Portland cement and 1-1/2 pt air entraining agent. Compressive strength 80 psi min.  
 See Perlite Aggregate (CFFX) category for names of Classified companies.

\*Bearing the UL Classification Mark

**SAFTY GLAZING:** The following shall be considered specific hazardous locations for the purpose of glazing: 1). Glazing in swinging doors except jalousies. 2). Glazing in fixed and sliding panels of sliding door assemblies and panels in sliding and bi-fold closet door assemblies. 3). Glazing in storm doors. 4). Glazing in all unframed swinging doors. 5). Glazing in doors and enclosures for hot tubs, whirlpools, saunas, steam rooms, bathtubs, and showers Glazing in any part of a building wall enclosing these compartments where the bottom exposed edge of the glazing is less than 60 inches measured vertically from a standing or walking surface. 6). Glazing in an individual fixed or operable panel adjacent to a door where the nearest vertical edge is within a 24-inch arc of the door in a closed position and whose bottom edge is less than 60 inches above the walking surface. 7). Glazing in an individual fixed or operable panel, other than those locations described in Items 5 & 6 above that meet all of the following conditions: 7.1). Exposed area of an individual pane greater than 9 square feet. 7.2). Bottom edge less than 18 inches above the floor. 7.3). Top edge greater than 36 inches above the floor. 7.4). One or more walking surfaces within 36 inches horizontally of the glazing. 8). All glazing in railings regardless of an area or height above a walking surface. Included are structural baluster panels and nonstructural in-fill panels. 9). Glazing in walls and fences enclosing indoor and outdoor swimming pools, hot tubs and spas where the bottom edge of the glazing is less than 60 inches above a walking surface and within 60 inches horizontally of the water's edge. This shall apply to single glazing and all panes in multiple glazing. 10). Glazing adjacent to stair ways, landings and ramps within 36 inches horizontally of a walking surface when the exposed surface of the glass is less than 36 inches above the plane of the adjacent walking surface of stairways, landings and ramps. 11). Glazing adjacent to stairways within 60 inches horizontally of the bottom tread or landing of a stairway in any direction when the exposed surface of the glass is less than 36 inches above the walking surface.

**EXCEPTIONS:** The following products, materials and uses are exempt from the above hazardous locations: 1). Openings in doors through which a 3-inch sphere is unable to pass. 2). Decorative glass in Items 1, 6, & 7. 3). Glazing in Section R308.4, Item 6, where there is an intervening wall or other permanent barrier between the door and the glazing. 4). Glazing in Section R308.4, item 6, in walls perpendicular to the plane of the door in a closed position or where access through the door is to a closet or storage area 3 feet or less in depth. Glazing in these applications shall comply with R308.4, Item 7. 5). Glazing in Section R308.4, Items 7 and 10, when a protective bar is installed on the accessible side(s) of the glazing 36 inches +/- 2" above the floor. The bar shall be capable of withstanding a horizontal load of 50 pounds per linear foot without contacting the glass and be a minimum of 1 1/2" in height. 6). Outboard panes in insulating glass units and other multiple glazed panels in Section R308.4, Item 7, when the bottom edge of the glass is 25 feet or more above grade, a roof, walking surface, or other horizontal surface adjacent to the glass exterior. 7). Louvered windows and jalousies complying with the requirements of Section R308.2. 8. Mirrors and other glass panels mounted or hung on a surface that provides a continuous backing support. 9). Safety glazing in Sec. R308.4, Items 10 and 11 is not required where: 9.1). The side of the stairway, landing or ramp has a guardrail complying with R312; and 9.2). The plan of the glass is greater than 18 inches from the railing.

**CARBON MONOXIDE DETECTORS:** Per **the IRC. For new construction,** an approved carbon monoxide alarm shall be installed outside of each separate sleeping area within 15' of all bedrooms in dwelling units within which fuel-fired appliances are installed and in dwelling units that have attached garages.

**For existing dwelling units,** Where work requiring a permit occurs in existing dwellings that have attached garages or in existing dwellings within which fuel-fired appliances exist, carbon monoxide alarms shall be provided in accordance with Section 315.1.

**Alarm requirements.** Single station carbon monoxide alarms shall be listed as complying with UL 2034 and shall be installed in accordance with this code and the manufacturer's installation instructions

**ALSO:** Colorado's law regarding the installation of carbon monoxide detectors became effective as of July 1, 2009. It applies to sales, rentals, and remodels of single and multi-family residences. All dwelling units that have a fuel-fired heater or appliance, a fireplace, or an attached garage must have a carbon monoxide detector located within fifteen feet of bedrooms. When a tenant moves out, the law requires that any CO detectors that were stolen, removed, missing, or inoperative be replaced and be functional before a new tenant moves into the unit. CO detectors may be (a) wired directly into the dwelling's electrical system, (b) plugged into an electrical outlet that is not switched or (c) battery-powered.