

**TOWN OF MOUNTAIN VILLAGE
TOWN COUNCIL REGULAR MEETING
THURSDAY, APRIL 21, 2022, 2:00 PM
2nd FLOOR CONFERENCE ROOM, MOUNTAIN VILLAGE TOWN HALL
455 MOUNTAIN VILLAGE BLVD, MOUNTAIN VILLAGE, COLORADO
AGENDA**

https://us06web.zoom.us/webinar/register/WN_DR-fbLkkQuGkOhwSi9hSBA

Please note that times are approximate and subject to change.

	Time	Min	Presenter	Type	
1.	2:00				Call to Order
2.	2:00	5			Public Comment on Non-Agenda Items
3.	2:05	10	Wisor	Work Session	Discussion Regarding Adding an Additional Monthly Town Council Meeting
4.	2:15	10	Johnston Kelly	Action Public Hearing Quasi-Judicial	Liquor Licensing Authority: a. Consideration of and Public Hearing on an Application for a New Tavern Liquor License for Communion, LLC dba Communion, Located at 567 Mountain Village Blvd #106C
5.	2:25	15	Miller	Action Quasi-Judicial	Consideration of a Resolution to Consider a Conditional Use Permit Development Application for the Placement of a Spider Jump and Ground School Activity Structures on OS3U, Active Open Space <i>Continued from the March 17, 2022 Town Council Meeting</i>
6.	2:40	30	Shindman Knudsten Haynes Wisor McConaughy	Action Legislative	First Reading, Setting of a Public Hearing and Council Vote on an Ordinance Amending Chapters 16.01, 16.02, 17.3 and 17.9 of the Community Development Code Concerning Affordable Housing Restrictions and Adopting Housing Impact Mitigation Requirements <i>Continued from the March 17, 2022 Town Council Meeting</i>
7.	3:10	10	Haynes McConaughy Wisor	Action Legislative	Second Reading, Public Hearing and Council Vote on an Ordinance Regarding Amendments the Community Development Code Section 17.2.3 Design Review Board to Remove the Term Limit Provision, Change the Term from Two Years to Four Years, Amend the Meeting Date from the 4 th Thursday to the 1 st Thursday and Address Lot Owner and Residency Requirements as it Related to Board Composition
8.	3:20	10	Wisor Haynes	Work Session	Directional Discussion Regarding the Timing of Adoption of Comprehensive Plan Amendments
9.	3:30	30	Haynes Wisor	Work Session	Discussion Regarding Site Planning, Density and Conceptual Design of Lot 644, the Meadows, a Public Private Partnership with Triumph West
10.	4:00	10	Wisor	Action	Consideration of Approval to Execute a Pre-Development Agreement with Triumph West Regarding Lot 644 Community Housing Development, Meadows Subarea
11.	4:10	15	Wisor Loebe Kjome Broady	Informational	Discussion Regarding a Proposed Agreement with Telluride Regional Airport for Parking Lot Use

**TOWN COUNCIL MEETING
AGENDA FOR APRIL 21, 2022**

12.	4:25	10	Wisor Loebe Kjome Broady	Informational	Construction of an Addition to the Gondola Parking Garage Update
13.	4:35	10	Andrew	Action	Consideration of Support of the San Juan Rural Philanthropy Days in Ridgway and Ouray County on June 7-9, 2022
14.	4:45	15	Haynes	Informational	Staff Reports: a. Housing, Planning & Development Services
15.	5:00	5		Informational	Other Business
16.	5:05	15			Dinner
17.	5:20	100	Wisor McConaughy Kjome (b)	Legal	Executive Session for the Purpose of Receiving Legal Advice and Determining Positions Relative to Matters that may be Subject to Negotiations, Developing Strategies for Negotiations, and Instructing Negotiators Related to: a. Engagement of Special Counsel Pursuant to Section 24-6-402(4)(b) and (e), C.R.S. b. Ski Ranches Water Service Pursuant to Section 24-6-402(4)(b) and (e), C.R.S. c. Lot 615-1CR Pursuant to Section 24-6-402(4)(b) and (e), C.R.S. d. Potential Purchase, Acquisition, or Lease, or Real Property Interest Pursuant to Section 24-6-402(4)(a), (b) and (e), C.R.S. e. Potential Purchase, Acquisition, or Lease, or Real Property Interest Pursuant to Section 24-6-402(4)(a), (b) and (e), C.R.S.
18.	7:00				Adjourn

Individuals with disabilities needing auxiliary aid(s) may request assistance by contacting Town Hall at 970-369-6429 or email: mvclerk@mtnvillage.org. A minimum notice of 48 hours is required so arrangements can be made to locate requested auxiliary aid(s)

<https://bit.ly/WatchMVMeetings>

Register in advance for this webinar:

https://us06web.zoom.us/webinar/register/WN_DR-fbLkKQuGkOhwSi9hSBA

After registering, you will receive a confirmation email containing information about joining the webinar.

Public Comment Policy:

- All public commenters must sign in on the public comment sign in sheet and indicate which item(s) they intend to give public comment on
Speakers shall wait to be recognized by the Mayor and shall give public comment at the public comment microphone when recognized by the Mayor
- Speakers shall state their full name and affiliation with the Town of Mountain Village if any
- Speakers shall be limited to three minutes with no aggregating of time through the representation of additional people
- Speakers shall refrain from personal attacks and shall keep comments to that of a civil tone
- No presentation of materials through the AV system shall be allowed for non-agendized speakers
- Written materials must be submitted 48 hours prior to the meeting date to be included in the meeting packet and of record. Written comment submitted within 48 hours will be accepted, but shall not be included in the packet or be deemed of record



AGENDA ITEM #3
TOWN MANAGER
455 Mountain Village Blvd.
Mountain Village, CO 81435
(970) 729-2654

TO: Mountain Village Town Council
FROM: Paul Wisor, Town Manager
DATE: April 13, 2022
RE: Discussion Regarding Adding an Additional Monthly Town Council Meeting

Executive Summary: Town staff anticipates future Town Council agendas will be quite extensive throughout the summer. In order to avoid Town Council meetings running in excess of eight hours, Town staff is suggesting adding an additional Town Council meeting each month.

Overview

Recently, Town Council could not address all the matters initially placed on the regular meeting agenda due to significant time constraints. Had all matters initially placed on the agenda been discussed, the meeting time for the regular meeting would have exceeded eight hours. As a result, Town Council held a second, shorter meeting, to address those issues that could not be discussed at the regular meeting.

Some members of Town Council indicated they thought holding a second, shorter, meeting was a good use of Town Council's time as it allowed councilmembers to more thoroughly review all packet materials and fully discuss all issues presented at both the regular and special meeting.

Proposed Second Meeting

Town staff anticipates the Town Council agendas for the next several months will be quite full. In order to avoid meetings running in excess of eight hours, Town staff is proposing a second meeting be added each month. Town staff is not proposing Town Council conduct a second meeting lasting approximately six hours. Rather, Town staff believes these second meetings should run up to two hours. Adding an extra meeting will allow Town Council more time to review and process packet materials. It is also hoped an additional meeting will provide Town Council with more time to discuss agenda items.

Currently, the Design Review Board meets the first Thursday of each month. It will be difficult for Town staff to facilitate both DRB and Town Council meetings on the same day. As a result, an additional meeting could be held on either the first or fourth Thursday of each month. Town staff proposes such meetings start at 3:00 and end around 5:00. Of course, the decision to hold a second meeting and the timing of such meeting is entirely up to Town Council.

Town of Mountain Village

Date: 4/14/2022
To: Town Council, Acting as the Liquor Licensing Authority (LLA)
From: Susan Johnston, Town Clerk
RE: Local Liquor Licensing Authority Matters for the April 21, 2022 Meeting

Consideration of a Public Hearing on an Application for a New Tavern Liquor License for Communion, LLC dba Communion, Located at 567 Mountain Village Blvd. #106C

All required documentation and fees have been received. The application has been reviewed by the following departments: Clerks, Legal and Police with no adverse findings. Fingerprinting and background check has been cleared with no findings. Letters of support are included in the packet materials. The required posting and noticing have occurred, and no comments were filed. The applicant has chosen to do a concurrent review with the State.

Staff recommendation: Motion to approve an application for a new tavern liquor license for Communion, LLC dba Communion located at 567 Mountain Village Blvd. #106C.

Colorado Liquor
Retail License Application

[] New License [x] New-Concurrent [] Transfer of Ownership [] State Property Only [] Master file

- All answers must be printed in black ink or typewritten
• Applicant must check the appropriate box(es)
• Applicant should obtain a copy of the Colorado Liquor and Beer Code: SBG.Colorado.gov/Liquor

1. Applicant is applying as a/an [] Individual [x] Limited Liability Company [] Association or Other
[] Corporation [] Partnership (includes Limited Liability and Husband and Wife Partnerships)

2. Applicant If an LLC, name of LLC; if partnership, at least 2 partner's names; if corporation, name of corporation
Communion, LLC FEIN Number

2a. Trade Name of Establishment (DBA) State Sales Tax Number Business Telephone
Communion (970) 538-9510

3. Address of Premises (specify exact location of premises, include suite/unit numbers)
567 Mountain Village Blvd., #106C

City Mountain Village County San Miguel State CO ZIP Code 81435

4. Mailing Address (Number and Street) City or Town State ZIP Code
Mountain Village CO 81435

5. Email Address
winstonkelly@gmail.com

6. If the premises currently has a liquor or beer license, you must answer the following questions

Present Trade Name of Establishment (DBA) Present State License Number Present Class of License Present Expiration Date
N/A

Section A Nonrefundable Application Fees* Section B (Cont.) Liquor License Fees*

- [] Application Fee for New License...\$1,100.00
[x] Application Fee for New License w/Concurrent Review ...\$1,200.00
[] Application Fee for Transfer ...\$1,100.00
[] Liquor-Licensed Drugstore (County) ...\$312.50
[] Lodging & Entertainment - L&E (City) ...\$500.00
[] Lodging & Entertainment - L&E (County) ...\$500.00

Section B Liquor License Fees*

- [] Add Optional Premises to H & R...\$100.00 X Total
[] Add Related Facility to Resort Complex\$75.00 X Total
[] Add Sidewalk Service Area...\$75.00
[] Arts License (City)...\$308.75
[] Arts License (County)...\$308.75
[] Beer and Wine License (City)...\$351.25
[] Beer and Wine License (County)...\$436.25
[] Brew Pub License (City)...\$750.00
[] Brew Pub License (County)...\$750.00
[] Campus Liquor Complex (City)...\$500.00
[] Campus Liquor Complex (County)...\$500.00
[] Campus Liquor Complex (State)...\$500.00
[] Club License (City)...\$308.75
[] Club License (County)...\$308.75
[] Distillery Pub License (City)...\$750.00
[] Distillery Pub License (County)...\$750.00
[] Hotel and Restaurant License (City)...\$500.00
[] Hotel and Restaurant License (County)...\$500.00
[] Hotel and Restaurant License w/one opt premises (City)...\$600.00
[] Hotel and Restaurant License w/one opt premises (County)...\$600.00
[] Liquor-Licensed Drugstore (City)...\$227.50
[] Manager Registration - H & R...\$75.00
[] Manager Registration - Tavern...\$75.00
[] Manager Registration - Lodging & Entertainment...\$75.00
[] Manager Registration - Campus Liquor Complex ...\$75.00
[] Optional Premises License (City)...\$500.00
[] Optional Premises License (County)...\$500.00
[] Racetrack License (City)...\$500.00
[] Racetrack License (County)...\$500.00
[] Resort Complex License (City)...\$500.00
[] Resort Complex License (County)...\$500.00
[] Related Facility - Campus Liquor Complex (City)...\$160.00
[] Related Facility - Campus Liquor Complex (County)...\$160.00
[] Related Facility - Campus Liquor Complex (State)...\$160.00
[] Retail Gaming Tavern License (City)...\$500.00
[] Retail Gaming Tavern License (County)...\$500.00
[] Retail Liquor Store License--Additional (City)...\$227.50
[] Retail Liquor Store License--Additional (County)...\$312.50
[] Retail Liquor Store (City)...\$227.50
[] Retail Liquor Store (County)...\$312.50
[x] Tavern License (City)...\$500.00
[] Tavern License (County)...\$500.00
[] Vintners Restaurant License (City)...\$750.00
[] Vintners Restaurant License (County)...\$750.00

* Note that the Division will not accept cash

Questions? Visit: SBG.Colorado.gov/Liquor for more information

Do not write in this space - For Department of Revenue use only

Liability Information

Table with 4 columns: License Account Number, Liability Date, License Issued Through (Expiration Date), Total \$

Application Documents Checklist and Worksheet

Instructions: This checklist should be utilized to assist applicants with filing all required documents for licensure. **All** documents must be properly signed and correspond with the name of the applicant exactly. **All** documents must be typed or legibly printed. Upon final State approval the license will be mailed to the local licensing authority. Application fees are nonrefundable. **Questions? Visit: SBG.Colorado.gov/Liquor for more information**

Items submitted, please check all appropriate boxes completed or documents submitted	
I.	Applicant information <input checked="" type="checkbox"/> A. Applicant/Licensee identified <input checked="" type="checkbox"/> B. State sales tax license number listed or applied for at time of application <input checked="" type="checkbox"/> C. License type or other transaction identified <input type="checkbox"/> D. Return originals to local authority (additional items may be required by the local licensing authority) <input checked="" type="checkbox"/> E. All sections of the application need to be completed <input type="checkbox"/> F. Master file applicants must include the Application for Master File form DR 8415 and applicable fees to this Retail License Application
II.	Diagram of the premises <input checked="" type="checkbox"/> A. No larger than 8 1/2" X 11" <input checked="" type="checkbox"/> B. Dimensions included (does not have to be to scale). Exterior areas should show type of control (fences, walls, entry/exit points, etc.) <input type="checkbox"/> C. Separate diagram for each floor (if multiple levels) <input type="checkbox"/> D. Kitchen - identified if Hotel and Restaurant <input checked="" type="checkbox"/> E. Bold/Outlined Licensed Premises
III.	Proof of property possession (One Year Needed) <input checked="" type="checkbox"/> A. Deed in name of the applicant (or) (matching question #2) date stamped / filed with County Clerk <input checked="" type="checkbox"/> B. Lease in the name of the applicant (or) (matching question #2) <input checked="" type="checkbox"/> C. Lease assignment in the name of the applicant with proper consent from the landlord and acceptance by the applicant <input type="checkbox"/> D. Other agreement if not deed or lease. (matching question #2)
IV.	Background information (DR 8404-I) and financial documents <input checked="" type="checkbox"/> A. Complete DR 8404-I for each principal (individuals with more than 10% ownership, officers, directors, partners, members) <input checked="" type="checkbox"/> B. Fingerprints taken and submitted to the appropriate Local Licensing Authority through an approved state vendor. Do not complete fingerprint cards prior to submitting your application. The Vendors are as follows: IdentoGO – https://uenroll.identogo.com/ Phone: 844-539-5539 (toll-free) Colorado Fingerprinting – http://www.coloradofingerprinting.com Appointment Scheduling Website: http://www.coloradofingerprinting.com/cabs/ Phone: 720-292-2722 Toll Free: 833-224-2227 Details about the vendors and fingerprinting in Colorado can be found on CBI's website here: https://cbi.colorado.gov/sections/biometric-identification-and-records-unit/employment-and-background-checks <input type="checkbox"/> C. Purchase agreement, stock transfer agreement, and/or authorization to transfer license <input type="checkbox"/> D. List of all notes and loans (Copies to also be attached)
V.	Sole proprietor/husband and wife partnership (if applicable) <input checked="" type="checkbox"/> A. Form DR 4679 <input checked="" type="checkbox"/> B. Copy of State issued Driver's License or Colorado Identification Card for each applicant
VI.	Corporate applicant information (if applicable) <input type="checkbox"/> A. Certificate of Incorporation <input type="checkbox"/> B. Certificate of Good Standing <input type="checkbox"/> C. Certificate of Authorization if foreign corporation (out of state applicants only)
VII.	Partnership applicant information (if applicable) <input type="checkbox"/> A. Partnership Agreement (general or limited). <input type="checkbox"/> B. Certificate of Good Standing
VIII.	Limited Liability Company applicant information (if applicable) <input checked="" type="checkbox"/> A. Copy of articles of organization <input checked="" type="checkbox"/> B. Certificate of Good Standing <input checked="" type="checkbox"/> C. Copy of Operating Agreement (if applicable) <input type="checkbox"/> D. Certificate of Authority if foreign LLC (out of state applicants only)
IX.	Manager registration for Hotel and Restaurant, Tavern, Lodging & Entertainment, and Campus Liquor Complex licenses when included with this application <input type="checkbox"/> A. \$75.00 fee <input type="checkbox"/> B. Individual History Record (DR 8404-I) <input type="checkbox"/> C. If owner is managing, no fee required

Name Communion, LLC	Type of License Tavern	Account Number		
7. Is the applicant (including any of the partners if a partnership; members or managers if a limited liability company; or officers, stockholders or directors if a corporation) or managers under the age of twenty-one years?		Yes <input type="checkbox"/> No <input checked="" type="checkbox"/>		
8. Has the applicant (including any of the partners if a partnership; members or managers if a limited liability company; or officers, stockholders or directors if a corporation) or managers ever (in Colorado or any other state):				
a. Been denied an alcohol beverage license?		<input type="checkbox"/> <input checked="" type="checkbox"/>		
b. Had an alcohol beverage license suspended or revoked?		<input type="checkbox"/> <input checked="" type="checkbox"/>		
c. Had interest in another entity that had an alcohol beverage license suspended or revoked?		<input type="checkbox"/> <input checked="" type="checkbox"/>		
If you answered yes to 8a, b or c, explain in detail on a separate sheet.				
9. Has a liquor license application (same license class), that was located within 500 feet of the proposed premises, been denied within the preceding two years? If "yes", explain in detail.		<input type="checkbox"/> <input checked="" type="checkbox"/>		
10. Are the premises to be licensed within 500 feet, of any public or private school that meets compulsory education requirements of Colorado law, or the principal campus of any college, university or seminary?		<input type="checkbox"/> <input checked="" type="checkbox"/>		
or				
Waiver by local ordinance?		<input type="checkbox"/> <input type="checkbox"/>		
Other: _____				
11. Is your Liquor Licensed Drugstore (LLDS) or Retail Liquor Store (RLS) within 1500 feet of another retail liquor license for off-premises sales in a jurisdiction with a population of greater than (>) 10,000? NOTE: The distance shall be determined by a radius measurement that begins at the principal doorway of the LLDS/RLS premises for which the application is being made and ends at the principal doorway of the Licensed LLDS/RLS.		<input type="checkbox"/> <input type="checkbox"/> N/A		
12. Is your Liquor Licensed Drugstore (LLDS) or Retail Liquor Store (RLS) within 3000 feet of another retail liquor license for off-premises sales in a jurisdiction with a population of less than (<) 10,000? NOTE: The distance shall be determined by a radius measurement that begins at the principal doorway of the LLDS/RLS premises for which the application is being made and ends at the principal doorway of the Licensed LLDS/RLS.		<input type="checkbox"/> <input type="checkbox"/> N/A		
13 a. For additional Retail Liquor Store only. Was your Retail Liquor Store License issued on or before January 1, 2016?		N/A <input type="checkbox"/> <input type="checkbox"/>		
13 b. Are you a Colorado resident?		N/A <input type="checkbox"/> <input type="checkbox"/>		
14. Has a liquor or beer license ever been issued to the applicant (including any of the partners, if a partnership; members or manager if a Limited Liability Company; or officers, stockholders or directors if a corporation)? If yes, identify the name of the business and list any <u>current</u> financial interest in said business including any loans to or from a licensee.		<input type="checkbox"/> <input checked="" type="checkbox"/>		
15. Does the applicant, as listed on line 2 of this application, have legal possession of the premises by ownership , lease or other arrangement?		<input checked="" type="checkbox"/> <input type="checkbox"/>		
<input type="checkbox"/> Ownership <input checked="" type="checkbox"/> Lease <input type="checkbox"/> Other (Explain in Detail) _____				
a. If leased, list name of landlord and tenant, and date of expiration, exactly as they appear on the lease:				
Landlord Scythian, Ltd	Tenant Communion, LLC	Expires 11/30/26		
b. Is a percentage of alcohol sales included as compensation to the landlord? If yes, complete question 16.		<input type="checkbox"/> <input checked="" type="checkbox"/>		
c. Attach a diagram that designates the area to be licensed in black bold outline (including dimensions) which shows the bars, brewery, walls, partitions, entrances, exits and what each room shall be utilized for in this business. This diagram should be no larger than 8 1/2" X 11".				
16. Who, besides the owners listed in this application (including persons, firms, partnerships, corporations, limited liability companies) will loan or give money, inventory, furniture or equipment to or for use in this business; or who will receive money from this business? Attach a separate sheet if necessary.				
Last Name None	First Name	Date of Birth	FEIN or SSN	Interest/Percentage
Last Name	First Name	Date of Birth	FEIN or SSN	Interest/Percentage
Attach copies of all notes and security instruments and any written agreement or details of any oral agreement, by which any person (including partnerships, corporations, limited liability companies, etc.) will share in the profit or gross proceeds of this establishment, and any agreement relating to the business which is contingent or conditional in any way by volume, profit, sales, giving of advice or consultation.				
17. Optional Premises or Hotel and Restaurant Licenses with Optional Premises: Has a local ordinance or resolution authorizing optional premises been adopted?		N/A <input type="checkbox"/> <input type="checkbox"/>		
Number of additional Optional Premise areas requested. (See license fee chart) _____				
18. For the addition of a Sidewalk Service Area per Regulation 47-302(A)(4), include a diagram of the service area and documentation received from the local governing body authorizing use of the sidewalk. Documentation may include but is not limited to a statement of use, permit, easement, or other legal permissions.				N/A
19. Liquor Licensed Drugstore (LLDS) applicants, answer the following:				
a. Is there a pharmacy, licensed by the Colorado Board of Pharmacy, located within the applicant's LLDS premise? If "yes" a copy of license must be attached.				N/A <input type="checkbox"/> <input type="checkbox"/>

Name Communion, LLC	Type of License Tavern	Account Number		
20. Club Liquor License applicants answer the following: Attach a copy of applicable documentation				
a. Is the applicant organization operated solely for a national, social, fraternal, patriotic, political or athletic purpose and not for pecuniary gain?	Yes	<input type="checkbox"/>		
b. Is the applicant organization a regularly chartered branch, lodge or chapter of a national organization which is operated solely for the object of a patriotic or fraternal organization or society, but not for pecuniary gain?	No	<input type="checkbox"/>		
c. How long has the club been incorporated?	N/A			
d. Has applicant occupied an establishment for three years (three years required) that was operated solely for the reasons stated above?	Yes	<input type="checkbox"/>		
21. Brew-Pub, Distillery Pub or Vintner's Restaurant applicants answer the following:				
a. Has the applicant received or applied for a Federal Permit? (Copy of permit or application must be attached)	No	N/A <input type="checkbox"/>		
22. Campus Liquor Complex applicants answer the following:				
a. Is the applicant an institution of higher education?	Yes	<input type="checkbox"/>		
b. Is the applicant a person who contracts with the institution of higher education to provide food services? If "yes" please provide a copy of the contract with the institution of higher education to provide food services.	No	N/A <input type="checkbox"/>		
23. For all on-premises applicants.				
a. Hotel and Restaurant, Lodging and Entertainment, Tavern License and Campus Liquor Complex, the Registered Manager must also submit an Individual History Record - DR 8404-I and fingerprint submitted to approved State Vendor through the Vendor's website. See application checklist, Section IV, for details.				
b. For all Liquor Licensed Drugstores (LLDS) the Permitted Manager must also submit a Manager Permit Application - DR 8000 and fingerprints.				
Last Name of Manager Kelly	First Name of Manager Winston			
24. Does this manager act as the manager of, or have a financial interest in, any other liquor licensed establishment in the State of Colorado? If yes, provide name, type of license and account number.				
		Yes <input type="checkbox"/> No <input checked="" type="checkbox"/>		
25. Related Facility - Campus Liquor Complex applicants answer the following:				
a. Is the related facility located within the boundaries of the Campus Liquor Complex? If yes, please provide a map of the geographical location within the Campus Liquor Complex. If no, this license type is not available for issues outside the geographical location of the Campus Liquor Complex.		Yes <input type="checkbox"/> No <input type="checkbox"/>		
b. Designated Manager for Related Facility- Campus Liquor Complex		N/A		
Last Name of Manager	First Name of Manager			
26. Tax Information.				
a. Has the applicant, including its manager, partners, officer, directors, stockholders, members (LLC), managing members (LLC), or any other person with a 10% or greater financial interest in the applicant, been found in final order of a tax agency to be delinquent in the payment of any state or local taxes, penalties, or interest related to a business?		Yes <input type="checkbox"/> No <input checked="" type="checkbox"/>		
b. Has the applicant, including its manager, partners, officer, directors, stockholders, members (LLC), managing members (LLC), or any other person with a 10% or greater financial interest in the applicant failed to pay any fees or surcharges imposed pursuant to section 44-3-503, C.R.S.?		Yes <input type="checkbox"/> No <input checked="" type="checkbox"/>		
27. If applicant is a corporation, partnership, association or limited liability company, applicant must list all Officers, Directors, General Partners, and Managing Members. In addition, applicant must list any stockholders, partners, or members with ownership of 10% or more in the applicant. All persons listed below must also attach form DR 8404-I (Individual History Record), and make an appointment with an approved State Vendor through their website. See application checklist, Section IV, for details.				
Name	Home Address, City & State	DOB	Position	%Owned
Winston Kelly	[REDACTED]	[REDACTED]	Member	50
Name	Home Address, City & State	DOB	Position	%Owned
CAmeron Kelly	[REDACTED]	[REDACTED]	Member	50
Name	Home Address, City & State	DOB	Position	%Owned
Name	Home Address, City & State	DOB	Position	%Owned
Name	Home Address, City & State	DOB	Position	%Owned
** If applicant is owned 100% by a parent company, please list the designated principal officer on above. ** Corporations - the President, Vice-President, Secretary and Treasurer must be accounted for above (Include ownership percentage if applicable) ** If total ownership percentage disclosed here does not total 100%, applicant must check this box: <input type="checkbox"/> Applicant affirms that no individual other than these disclosed herein owns 10% or more of the applicant and does not have financial interest in a prohibited liquor license pursuant to Article 3 or 5, C.R.S.				

Name <i>Communion LLC</i>	Type of License <i>Tavern</i>	Account Number
Oath Of Applicant		
I declare under penalty of perjury in the second degree that this application and all attachments are true, correct, and complete to the best of my knowledge. I also acknowledge that it is my responsibility and the responsibility of my agents and employees to comply with the provisions of the Colorado Liquor or Beer Code which affect my license.		
Authorized Signature <i>Winston Kelly</i>	Printed Name and Title <i>Winston Kelly, Owner</i>	Date <i>10/29/21</i>
Report and Approval of Local Licensing Authority (City/County)		
Date application filed with local authority	Date of local authority hearing (for new license applicants; cannot be less than 30 days from date of application)	
The Local Licensing Authority Hereby Affirms that each person required to file DR 8404-1 (Individual History Record) or a DR 8000 (Manager Permit) has been:		
<input checked="" type="checkbox"/> Fingerprinted <input checked="" type="checkbox"/> Subject to background investigation, including NCIC/CCIC check for outstanding warrants		
That the local authority has conducted, or intends to conduct, an inspection of the proposed premises to ensure that the applicant is in compliance with and aware of, liquor code provisions affecting their class of license		
(Check One)		
<input type="checkbox"/> Date of inspection or anticipated date _____ <input checked="" type="checkbox"/> Will conduct inspection upon approval of state licensing authority		
<input type="checkbox"/> Is the Liquor Licensed Drugstore (LLDS) or Retail Liquor Store (RLS) within 1,500 feet of another retail liquor license for off-premises sales in a jurisdiction with a population of > 10,0000?		Yes No <input type="checkbox"/> <input type="checkbox"/>
<input type="checkbox"/> Is the Liquor Licensed Drugstore(LLDS) or Retail Liquor Store (RLS) within 3,000 feet of another retail liquor license for off-premises sales in a jurisdiction with a population of < 10,0000?		<input type="checkbox"/> <input type="checkbox"/>
NOTE: The distance shall be determined by a radius measurement that begins at the principal doorway of the LLDS/RLS premises for which the application is being made and ends at the principal doorway of the Licensed LLDS/RLS.		
<input type="checkbox"/> Does the Liquor-Licensed Drugstore (LLDS) have at least twenty percent (20%) of the applicant's gross annual income derived from the sale of food, during the prior twelve (12) month period?		<input type="checkbox"/> <input type="checkbox"/>
The foregoing application has been examined; and the premises, business to be conducted, and character of the applicant are satisfactory. We do report that such license, if granted, will meet the reasonable requirements of the neighborhood and the desires of the adult inhabitants, and will comply with the provisions of Title 44, Article 4 or 3, C.R.S., and Liquor Rules. Therefore, this application is approved.		
Local Licensing Authority for <i>Town of Mountain Village</i>	Telephone Number <i>970-369-6429</i>	<input checked="" type="checkbox"/> Town, City <input type="checkbox"/> County
Signature <i>Susan Johnson</i>	Print <i>Susan Johnson</i>	Title <i>Town Clerk</i>
Signature	Print	Title
		Date

Communion, LLC
 576 Mountain Village Blvd, Suite 106C
 Mountain Village, CO 81435

UNIT 106C

1,603 SQ.FT.
 C.H.=12.00'

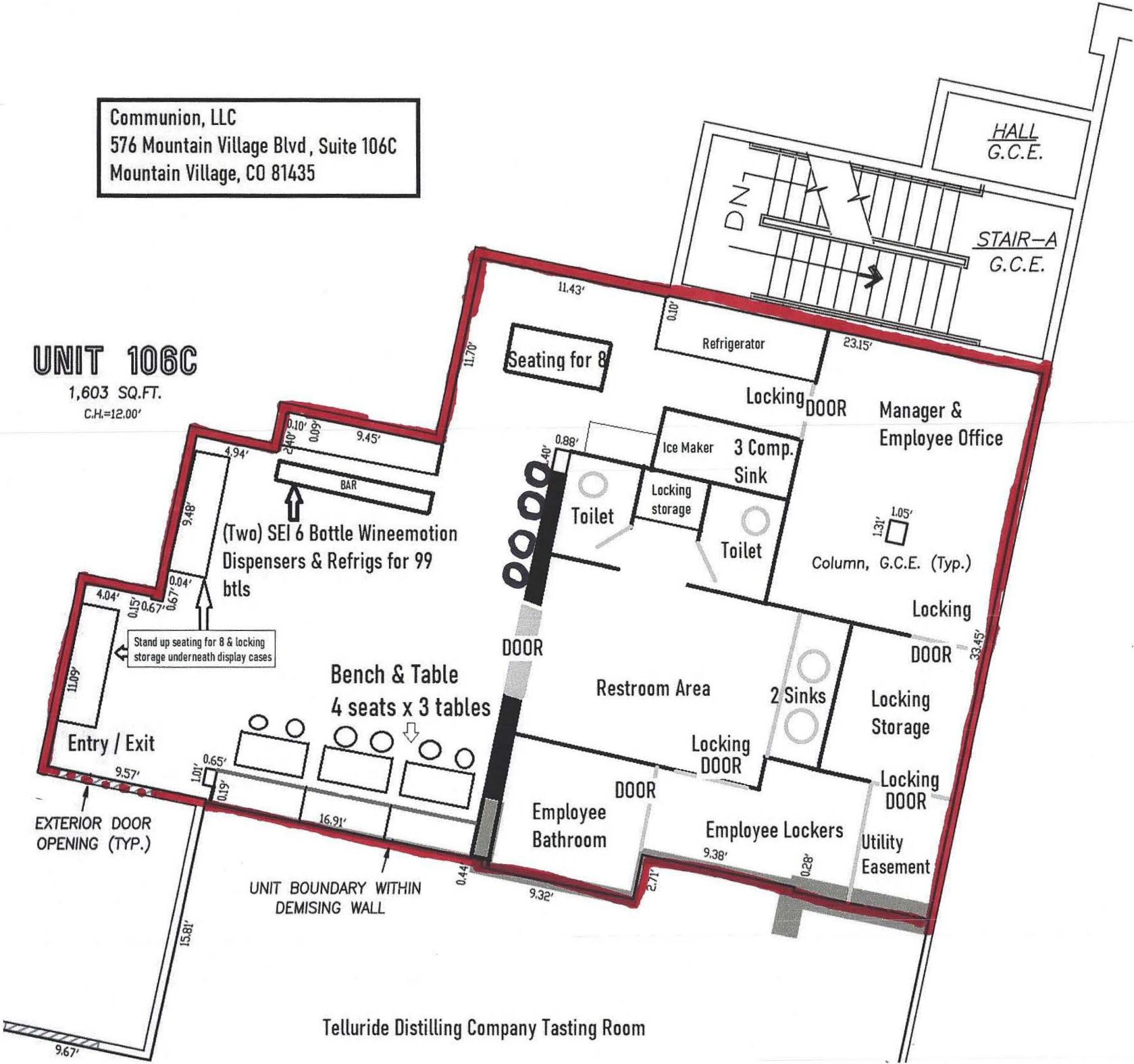

Telluride Distilling Company Tasting Room



Hello!

Communion Wine Bar in **Mountain Village** (567 Mountain Village Blvd, Suite 106C), is asking for your support to open a space for everyone to enjoy, beginning this summer. The definition of **Communion** is ‘common union’ and we aim to be a meeting place for everyone – from old to young, with or without alcohol, and from every walk of life. You can either stay to enjoy it in our newly renovated space, take it to go, or we are available for private events as well. For eating pleasure, Communion will offer vacuum sealed charcuterie boards, cheese boards, and vegetable boards; have 1 or try all 3.

Communion is setting its sights high, by providing a high-end atmosphere with furnishings, finishes, and gemstones. We will be featuring Telluride local, Orion Willits, beautiful photographic artwork on the walls and sourced a historic 1869 church pew restored by a local Dolores artist. We have built a model that fits into the current Mountain Village offerings of beer, liquor, *and now wine*. Our focus is great wines by the glass, to enjoy with us or to enjoy in the common consumption areas. We have invested in two Winemotion ‘wine by the glass’ machines that dispense a single glass of wine from a selection of 12 bottles. These machines are able to keep wine fresh for longer periods, which allows for very little waste, higher end offerings, and responsible measured pours.

We are partnering with Oulli Durham and Dustin Clements, both successful local wine sommeliers, who will provide a curated wine selection, from high end wines to affordable entry level wines, and everything in between. In addition to wines by the glass, **Communion** will offer a limited amount of select liquors and high-end bottled beers for non-wine drinkers. We want **Communion** to be a place for everyone to enjoy, and with that we take pride in offering non-alcoholic wines, beers, cocktails, and other refreshments. We envision **Communion** to be an exciting, first-class gathering place for all of Mountain Village and visitors from Telluride.

Since **Communion** is a ‘by the glass’ establishment and not a bottle shop, we will work well alongside Bryan and the bottle shop of Mountain Village Wine Merchants for wine events, referrals, and collaborations. We already have excellent relationships with our current neighbors throughout the Mountain Village Core and look forward to this opportunity to bring even more excitement and vibrancy. **Communion** will also serve as a wonderful place for private events, from local organizations and festivals, to weddings and luxury dinners, we are able to accommodate a wide variety of needs.

Dustin Clements moved to the region in the winter of 2005/2006. He has worked within the food and beverage industry throughout his tenure here. In 2010 he started working in the retail alcohol side of the industry, and started studying for his sommelier certifications. He continued in the retail and restaurant side of the industry until 2017 when his passion led him to wholesale sales, as well as production. He spent the next few years as assistant winemaker at Sutcliffe Vineyards in Cortez, CO, as well as a sales rep for a small boutique wine distributor. He is currently the award-winning head distiller for Telluride Distilling Company, and oversees day to day operations there. He is looking forward to continuing the path in the field of his passion, through Communion Wine Bar.

Oulli Durham moved to Telluride in the winter of 2007/2008. He has over 20+ years of experience in the hospitality industry. He has worked as wine director for the Cosmopolitan restaurant, and currently works at Alpino Vino, the highest fine dining restaurant in North America, since 2014. During this time, he has cultivated a deep knowledge and passion for wine. He has worked alongside Dustin Clements, Telski Wine Director Andrew Schafner, and Katie Hall, to create the Colorado sourced Telluride Red. He is excited for the opportunity to continue his passion with Communion Wine Bar.

Cameron & Winston Kelly moved to Mountain Village in the fall of 2016 and are heavily invested in the current and future potential of the Mountain Village community. They have a son that attends Telluride Mountain School and one more child due this summer. They are engaged members of Mountain Village, support local foundations and festivals through their philanthropy, and actively pursue what is best for our community, which they believe Communion will be. They want to provide a friend & family atmosphere, and a place where they can engage and give back to the community. The Kelly's also have a passion for wine, as the family produces private label estate wine in the Fredericksburg Hill Country since 2006.

We want to thank each of you for your consideration and enthusiasm on this project. We have confidence that **Communion** is going to be a wonderful addition, add vibrancy, and be a welcomed meeting place for both locals and visitors alike. We ask you to please approve our vision so that we may add another great asset to the community. Cheers!

Sincerely,

Dustin, Oulli, Cameron & Winston

Communion Wine Bar

Letter of Support

1 message

Garrett Brafford <gbrafford1@gmail.com>
To: Winston Kelly <winstonkelly@gmail.com>

Thu, Apr 7, 2022 at 5:00 PM

Letter of Support – Communion, LLC in Mountain Village

To whom it may concern,

I am writing this letter to support Communion as an addition to the Mountain Village businesses. Communion's wine bar concept is a much-needed addition to the Village core and will complement the existing retail, beer and liquor offerings.

Mr. Winston Kelly, the owner of Communion, and his business partners are very knowledgeable about wine, and well experienced in customer service and related business operations. Mr. Kelly is reliable, responsible and very capable of running a high-end establishment that will enhance the experience of residents and guests in Mountain Village.

Sincerely,

Garrett Brafford
Mountain Village Resident

Thank you,

Garrett Brafford
Owner & CEO
Telluride Consulting, LLC
Telluride Homeowner & Association Management, LLC
Catapult Consulting, LLC

PO Box 1327
Telluride, CO 81435
gbrafford1@gmail.com
Cell: (919) 800-8223
Office: (970) 239-4593
www.tellurideconsulting.com





To whom it may concern:

I am writing this letter in support of issuing a liquor license for **Communion Wine Bar** in Mountain Village.

The wine bar will be a nice addition and fit perfectly with the current atmosphere as well as help build the vitality within the Mountain Village Core. As our neighbors to the tasting room, we can attest that the owners have been working extremely hard on the space and we are anxiously waiting for Communion Wine Bar to be open for business.

In addition, as this venue will be available to rent for private events, we look forward to Communion Wine Bar bringing more people to the Mountain Village Core. This will certainly bring additional income to other businesses within the Core along with sales tax dollars to Mountain Village.

Cameron and Winston Kelly are responsible and very caring. They are also very dedicated to help Mountain Village continue grow and reach its full potential. We have worked with them in the past, and look forward to a continued business relationship alongside Communion Wine Bar.

Sincerely,

Joanna and Abbott Smith
Telluride Distilling Company

From: Steve Hemphill shemphill@colorado145.com
Subject: Tavern License Letter of Support
Date: Apr 8, 2022 at 12:47:16 PM
To: winstonkelly@gmail.com

To Whom it May Concern:

We are writing to express our support for Winston Kelly and for the issuance of a Tavern License to Communion Wine Bar in Mountain Village, CO.

Respectfully,

Steve & Karyn Hemphill
Owners of Sunshine Pharmacy and Colorado 145 Jeep Rentals



Dear Mountain Village Town Council,

I'm writing to advocate for an on premise liquor license for Communion Wine Bar. I have known Dustin Clements and Ouilli Durham for a long time and I'm excited that they will get to bring their expertise to the Mountain Village Core. Mountain Village is in need of a wine bar and Communion will bring an awesome and focused alternative to the other restaurants and bars. As the owner of the Mountain Village Wine Merchant I'm excited to work with Communion on making the town of Mountain Village a wine destination!

Cheers,
Bryan Thames
Owner MVWM

From: **Counter Culture** <catering@counterculturetelluride.com>

Date: Fri, Apr 1, 2022, 11:56

Subject: Re: Communion Wine Bar support

To: Dustin Clements <dkclements@gmail.com>

To Whom it May Concern:

As future neighbors of Communion Wine Bar, we would like to express our enthusiastic support for their presence in Mountain Village. They will be a fantastic addition to the business community up here. We have worked with Ouli at Alpino Vino for many years and can vouch for his professionalism and dedication to wine and service in this town. Dustin, in his role at Telluride Distilling, is currently our neighbor at our Lawson Hill location and is extremely passionate about the local food and beverage scene, and values being a good community member. We know they will be good tenants of the Village core and their offering is a great addition and complement to the existing businesses here. Thank you.

Steve Hertzfeld, Taylor Landry, Grace Mayer
Counter Culture co-owners

To whom it may concern:

My name is Mickey Salloway,

I am writing in support of granting a liquor license for Communion Wine Bar in Mountain Village. I think the wine bar will be a nice addition and will cater well to a different clientele of residents and visitors alike. We need a new place like this.

The owner of Communion is a friend and asset to the community. The partners in Communion Wine Bar are professionals and the space is beautiful.

Mickey Salloway

Long term resident Mountain Village and Neighbor of Communion

Cell:612-716-6903

Mickskiandgolf1@gmail.com

From: Tony Kalyk <tony@cadencehg.com>
Sent: Saturday, April 2, 2022 4:03 PM
To: mvclerk <mvclerk@mtnvillage.org>
Subject: Letter of Support: Communion Wine Bar

To Whom It May Concern:

My name is Tony Kalyk and I operate the Telluride Conference Center.

I would like to offer my support for the approval of the requested liquor license for Communion Wine Bar.

It is my belief that more entertainment options are a must for the vibrancy of Mountain Village. Additionally, a wine bar could work in synergy with the TCC.

Thank you for your time,

Tony Kalyk

Fwd: Communion

1 message

Cameron Kelly <cameronskelly8@gmail.com>

Thu, Apr 7, 2022 at 5:02 PM

To: ♥My Husband♥ <winstonkelly@gmail.com>

----- Forwarded message -----

From: Sage Martin <sage@mountainfilm.org>**Date:** Apr 7, 2022, 4:46 PM -0600**To:** Cameron Kelly <cameronskelly8@gmail.com>**Subject:** Communion

To Whom it May Concern,

I am happy to offer a letter of support for the new Mountain Village business, Communion.

Communion is a wine bar with high end liquor, beer and non alcoholic selections. It will be a perfect addition to the businesses in the Mountain Village core as it offers a gathering spot for visitors, homeowners and local organizations.

In addition, the space will be available to rent for private events. As someone who runs a festival and is constantly looking for event and party space, this would be an incredible new amenity.

The owners of the space, Cameron and Winston Kelly, are year-round residents who care deeply about the community and will ensure this new business adds to the vibrancy of the Mountain Village core.

Warmly,

Sage

SAGE MARTIN | Executive Director

She/Her/Hers

(970) 728-4123 x810

PO Box 1088, Telluride, CO 81435

Festival Dates: May 26 - 30, 2022

After the Fest ONLINE: May 31 - June 7, 2022

Carson Taylor
Telluride Ski & Golf LLC
565 Mountain Village Blvd
Mountain Village, CO 81435
April 9, 2022

Winston Kelly
Owner
Communion Wine Bar
Conference Center Plaza
Mountain Village, CO 81435

To Whom it May Concern:

I have been fortunate enough to live and work in the Telluride and Mountain Village communities for over 17 years, primarily as the Director of Mountain Sales for the Telluride Ski & Golf Resort. During this time; I've interacted with much of the business community and would like to provide a professional reference for my friend and neighbor, Winston Kelly.

Winston's new business endeavor, Communion Wine Bar, stands to further foster the vibrancy of Mountain Village and deliver a new option for both the community's and guests' experience in the core. Winston is a respectful, intelligent, and dedicated member of the community.

If you would like additional information about Winston, then please contact me via email or phone. Thank you for the time and consideration.

Sincerely,

Carson Taylor
Director | Mountain Sales
ctaylor@telski.com
970.728.7412



Hello! **Communion Wine Bar** in **Mountain Village** (567 Mountain Village Blvd, Suite 106C), is asking for your support to open a space for everyone to enjoy this summer. The definition of Communion is 'common union' and we aim to be a meeting place for everyone old to young, with or without alcohol, stay to enjoy or take it to go, and also private events! Please show support by signing, Thank you!

Name

Affiliation

1	Ryan Hoglund	Kylund custom Rod's
2	Taylor Franze	TDC Bar Manager
3	H. Kae Walker - Manning	H. KAE WALLACE - MANNING
4	Laura West	Laura West - TSPORTS ^{Telluride}
5	JEFF HOLDENSON	JEFF HOLDENSON SPORTS FKL
6	SAM TISCHE MDORF	BOOTDOCTORS.
7	CLAIRE BEARD	TELLURIDE CHAMBER MUSIC
8	Justice Hypes	Lucchese Bootmaker
9	Kari Melvin	"
10	Dawn C. Miller	Rolling Relaxation Massage
11	Jenni Watkins	Sunny Side Bakery
12	ERIN LYNCH	Tomboy-SOVS

Name

Affiliation

13	Sal Tenorio	Bar Tender Poacher Snowmaker
14	Kirstie Richard	Bar tender @ Poachers
15	Mike McCall	SKI Instructor
16	David B Steck	Competition services
17	Kindly Craig	TREC
18	Timothy McClough	1 Springs Creek/Oak Tavern
19	Sebastian	TREC
20	DOUGLAS FORD	Exceptional Steeps ^{Homeowner} also
21	Bec Brownell	Wax Guru
22	JOEY MARTIN	High Pie
23	David King	Wax Guru
24	Stane Brownell	Wax Guru
25	Eric Williams	FARMONT ENG
26	Ken Eger	Boot Doctors
27	JULIA LEVINE	HOME OWNER
28	David Baker	Boot Docs
29	Galena Garcia Blanco	Tracks Bar-tender
30	LUIS COENA	TRACKS CAFE.
31	Jenna Heming	Altezza at the Peaks
32	Charles Higginbotham	resident enthusiast
33	Kathleen	CEO - TERRA IMAGINA
34	Walt Smith	ISD Construction

Name

Affiliation

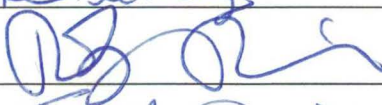
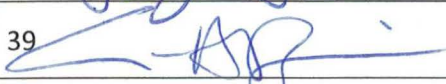
35	Wyatt Adams Swartz	TeLSki
36	Kevin Lawrence	Patron
37	KE Fleming	TBC Ass. Manager.
38		TBC - CMS
39		Counter Culture
40	John H. Young	TSG, OPB
41	Molly Norton	TSG
42	Tyler Simmons	EAP
43	Jessika Duggan	Tracks Bar manager
44	William V Schwengel	Business/Home owner
45	Kim Macken	TELSKI - SKI SCHOOL
46	Rich Hamilton	SMC PARKS
47	Ross Thistlethwaite	Telluride Tours
48	William Walker	RESIDENT
49	Jason Stachurski	Resident +
50	Charlie Cihlein	Resident
51	Ian Harper	Resident
52	Kyle Tawilo	Resident
53	William Vega	Resident
54	Sandy Camacho	Resident
55	Con A Johnson	Resident
56	James Higgins	Resident



Name

Affiliation

57	Karsen Granning	Telluride Distilling
58	Charlie Haver	telluride Distilling
59	Anton Kress	Telluride Brewing Company
60	Maxfield Otwell	Telluride Coffee
61	Andrew Hershey	Telluride Coffee
62	Brian Weinfurter	Telluride Brewing Company
63	Carly Latchum	Home owner, M.V.
64	Fate Goldberg	COUNTER CULTURE
65	Grace Moxey	Owner of Counter Culture
66	Matt Sorse	Telluride Brewing Co.
67	David Ritter	Home owner
68	Jessie Ritter	Homeowner
69	David Ritter ^{Fuss} ^{CRACE}	Telluride Brewing + Homeowner
70	Monica Throny	Telluride Brewing President +
71	Christ Fish	Telluride Brewing Co. member / New member
72	Matt Sumner	TBC + homeowner
73	James Galloway	TBC + Telluride Coffee Roastery
74	Rust F	Town of Mountain Village
75	Sam	Telluride Brewing
76	Ett Gilli	Counter Culture Employee
77	Stephen Hertzfeld	Counter Culture
78	Jeremy Goulding	Tracks Cafe

Name

Affiliation

	Name	Affiliation
79	Alex Martin	TREC
80	Trina Jackson	Homeowner
81	Cabe Adams	Bootdoctors
82	Blake Labuto	Bootdoctors
83	Heidi Sarazen	Telluride Brewing
84	Sarah Zaubi	Local
85	Megan Zaubi	Brown Dog
86	Andrew Manton	Teksh!
87	Nathan Hazze	TSG
88	Norm TOURIGNY 	20 yr ^{RESIDENT} / NEW SHERIDAN
89	Katie Cox	Communion extraordinaire ✓ alpine Lodging
90	Sarah HARKNESS	HDPM
91	Samantha A. Fernandez	 Stronghouse
92	Andrew Edwards	
93	ANDY COX	MV Resident 12 yrs
94	Crystal Glynn	TSG / COSMO
95	Wister Filly	Home Owner
96	Cameron Filly	Home Owner
97	Wickey Salloway	Home owner
98	Matt Sandoval	Contractor
99	KC Kai'ssi	Neighbor
100	Marein Ostromecki	TREC / Patron



Hello! **Communion Wine Bar** in **Mountain Village** (567 Mountain Village Blvd, Suite 106C), is asking for your support to open a space for everyone to enjoy this summer. The definition of Communion is 'common union' and we aim to be a meeting place for everyone old to young, with or without alcohol, stay to enjoy or take it to go, and also private events! Please show support by signing, Thank you!

Name

Affiliation

	Name	Affiliation
101	Mel Ashley	Resident
102	MIA McLaughlin	Resident
103	Rustin Clements	Telluride Distilling Co
104	DEREK MEREDITH	RESIDENT
105	Matthew J. Beaver	Resident
106	Scott Callahan	Tel ski Park crew
107	Nathan A. Sebrue	Ski & Snowboard School
108	Nick VARNHORN	Resident
109	Matthew Harrington	Resident
110	Kay Ferdon	??
111	Jonathan Braeger	Resident Home Owner
112	William Rebe Felicelli	Resident, Former Mayor

Name

Affiliation

	Name	Affiliation
113	Sofere Patterson	49 yr resident
114	Dylan Conne	4 yr
115	Kyle Bellitti	49 yr resident
116	Isaac Ball	3 yr resident
117	Gary Aristolou	4 YR
118	Carolyn Findlay	10 yr
119	Ben Marx	5 year
120	Amy Ulreich	MtNlV Owner 15 year
121	Dwight Olivier	15 year
122	Steven Collins	resident
123	Emerson Clark	res
124	Nicholas Goforth	Rico Resident
125	Wendell Susantverson	MV Resident
126	Kayla Hanson Kayla Hanson	MV Resident
127	ROBERT POWE Robert Powe	MV RES
128	A.J. Ahlde A.S. REKDAHL	25 YR RESIDENT
129	ERIK BUILDER/EMMITZ	MV RESIDENT
130	Kae Money	MV resident, 2 yearliky
131	Sam Ender	Stronghouse Brewery
132	Malaine Clark	AntHaa School / Telluride Brewing Co
133	Erin Kress	Telluride Ski Resort Employee
134	Johannes Beere	John



Hello! **Communion Wine Bar** in **Mountain Village** (567 Mountain Village Blvd, Suite 106C), is asking for your support to open a space for everyone to enjoy this summer. The definition of Communion is 'common union' and we aim to be a meeting place for everyone old to young, with or without alcohol, stay to enjoy or take it to go, and also private events! Please show support by signing, Thank you!





Name

Affiliation

135	Valerie Warburton Valerie Warburton	Distributor - Empire Distributors
136	BENSON WORTHINGTON	WINE ENTHUSIAST
137	MATT WORTHINGTON	CO-WORKER @ ALPINO VINO
138	Benji Biber	BEVERAGE SLINGER
139	Adam Buck	Bartender
140	Robbie Dru	DAK
141	Anna Blanton	Boatdoctor MV
142	Buck Smith	Boatclubs and Christy Sports.
143	ANDREW SHAFFNER	Wine Director Telluride SKI & Golf RESORT
144	Rob Reyna	Rustico Asst. Mgr + Alpino VINO server
145	Paige Metzner	Alpinist & the Great Lakes
146	Brent England	National Resto Asst. GM

Name

Affiliation

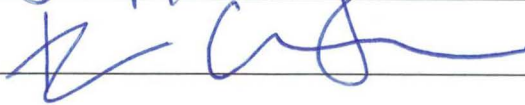
147	Leo Herrick 	Homeowner, Helitax
148	KATHYAN TATUM 	Homeowner, Artist, SLATE BRAY BAKERY
149	Thm Tatum	Homeown Telluride Town.
150	Helen Coulter Conlin	Over the Moon, Owner Telluride
151	Brian Thomas Conlin	Local Celebrity/Fishology Guide
152	BRYAN BAILEY	Local / consumer of WINB
153	Rob Rowitch	Local wind
154	Tom Reagan	Telluride Resident
155	Emily Rowitch	Local
156	Lucy Regan	Telluride Resident
157	Jess Kreifels	Queen of Saturday
158	Kelsey Colvin	Wine Queen
159	Todd Herrick	Helitax
160	Jane Cronk	Alpino Vino Ambassador
161	Pat Ryan	Local
162	Cheri Russell	Local. Telski exec.
163	Mark Rineer 	La Marmotte
164	Michael Hayes 	GM Stronghouse
165	Maureen Pelisson	M. Pen Telluride Daily News
166	Jana Kelly	One to One Ex Director
167	Scott Kelley	Broker TREC-MV
168		Broker

Name

Affiliation

169

PAT PELISSON

RESIDENT-TOT

170

PJ Kelley

Manager Brown Dog Pizza



TO: Mountain Village Design Review Board

FROM: John Miller, Principal Planner

FOR: Mountain Village Town Council Public Hearing; April 21, 2022

DATE: April 2, 2022

RE: Consideration of a resolution approving a Conditional Use Permit for the Placement of a Bungee Trampoline Activity and Canopy Tour Training area on OS-3U, Active Open Space

APPLICATION OVERVIEW: The purpose and intent of this memo is to provide information for Town Council as it relates to the placement of a Bungee Trampoline Activity (Spider-Jump) and Canopy Tour training area on OS-3U, Active Open Space.

PROJECT GEOGRAPHY

Legal Description: OS-3U, Mountain Village
Address: No address assigned to Active Open Space

Applicant/Agent: Carson Taylor, TSG
Owner: TSG Ski and Golf LLC
Zoning: Active Open Space (AOS)
Existing Use: AOS
Proposed Use: AOS

- Adjacent Land Uses:**
- **North:** AOS, Village Center
 - **South:** AOS
 - **East:** AOS, Single Family
 - **West:** AOS, Village Center

ATTACHMENTS

Exhibit A: Vicinity Map
Exhibit B: Application
Exhibit C: Resolution No. 2014-0515-16



Figure 1: Vicinity Map

BACKGROUND

Carson Taylor of Telluride Ski and Golf (applicant) has requested Town Council approval of a Class 4 Conditional Use Permit for the placement of a Bungee Trampoline Activity and Canopy Tour training area to be located on Lot OS-3U near the Heritage Plaza. Due to the nature of this activity, it is generally limited to summer months. It should be noted that the Bungee Trampoline Activity has been in operation since at least 2010 and has received no complaints from any Town Departments or the General Public. Additionally, TSG Ski and Golf LLC is proposing to locate what is described as the “Canopy Tour Ground School”, which will be used to practice and develop necessary skills for the recently completed canopy tour.

CRITERIA FOR DECISION

1. The following criteria shall be met for the review authority to approve a conditional use permit:
 - a. The proposed conditional use is in general conformity with the policies of the principles, policies and actions set forth in the Comprehensive Plan;
 - b. The proposed conditional use is in harmony and compatible with surrounding land uses and the neighborhood and will not create a substantial adverse impact on adjacent properties or on services and infrastructure;
 - c. The design, development and operation of the proposed conditional use shall not constitute a substantial physical hazard to the neighborhood, public facilities, infrastructure or open space;
 - d. The design, development and operation of the proposed conditional use shall not have significant adverse effect to the surrounding property owners and uses;
 - e. The design, development and operation of the proposed conditional use shall not have a significant adverse effect on open space or the purposes of the facilities owned by the Town;
 - f. The design, development and operation of the proposed conditional use shall minimize adverse environmental and visual impacts to the extent possible considering the nature of the proposed conditional use;
 - g. The design, development and operation of the proposed conditional use shall provide adequate infrastructure;
 - h. The proposed conditional use does not potentially damage or contaminate any public, private, residential, or agricultural water supply source; and
 - i. The proposed conditional use permit meets all applicable Town regulations and standards.

ANALYSIS

The Town of Mountain Village Comprehensive Plan references recreational activities to complement the ski resort area during the summer months. The Bungee Trampoline Activity (Spider-Jump) has been a long, ongoing occurrence in the town, since at least 2010, and the proposed continuation of this use is in alignment with surrounding land uses and should not create any adverse impact. The design of both the spider-jump and the canopy tour practice area are such that they will not create any physical hazards or significant adverse effects, and have minimized environmental and visual impacts with their placement. There is adequate infrastructure available for the project, and the proposal does not contaminate or damage any water supply source. Overall, it appears that this proposal meets the requirements of the CDC and the Town. Conditional uses are typically permitted for a 3 year period, and therefore, staff would recommend Approval through April 21, 2025.

STAFF RECOMMENDATION

Based on the criteria listed in this staff memo of record, staff recommends Town Council approval the conditional use permit to allow the placement of a Bungee Jump Activity and Canopy Tour Training Area on OS-3U, with the proposed motion set forth below:

Town Council Proposed Motion:

"I move to approve the resolution approving the conditional use permit for the Bungee Trampoline Activity on Lot OS-3U, as recommended by staff and the Design Review Board, with the following conditions:

1. *The Applicant shall maintain adequate bike traffic access from the bottom of the bike park to the Village Center plazas with either stations or hard fence to segregate bikers using the bike park, and users and spectators of the bungee trampoline activity; the design of the stations or hard fence shall be reviewed by Planning Divisions Staff prior to installation.*
2. *The Applicant shall secure the structure, including, without limitation, the pool, ladders, and other elements that might attract public access when closed.*
3. *In the event of water limitations or restrictions, the Applicant shall close the pool portion of the bungee trampoline activity structure.*
4. *The Applicant shall re-surface all disturbed areas with landscaping and provide seating for spectators.*
5. *Applicant shall provide an erosion control and drainage plan to ensure protection of the wetlands in the surrounding area.*
6. *The Applicant shall revise the site and grading plan to have appropriate finished grade material, benches, and simple landscaping to improve the appearance of the bungee trampoline activity, site grading, and the existing condition of the site.*
7. *This Conditional Use Permit shall be valid for a period of three (3) years with an annual review by the Planning Division staff, with the Applicant responding to any valid issues as they arise during the operation or the annual review."*

Carson Taylor
Director | Mountain Sales
Telluride Ski & Golf, LLC
November 16, 2021

Community Development Department
Planning Division
Town of Mountain Village
455 Mountain Village Blvd
Mountain Village, CO 81435

Dear Community Development Department:

The Mountain Activity Sales department offers a multitude of easily accessible activities for spring, summer, and fall visitors alike. In the summer of 2018 we took ownership of the historically offered kid/family-oriented activities in Heritage Plaza. Since then we've operated a ropes course, mining sluice, and bungee trampoline with the service and professionalism standards set forth by the Telluride Ski & Golf Resort.

Our application renewal requests that both the Spider Jump and mining sluice activities remain in their most recently and/or historical locations in OS-3U (Spider Jump) and Heritage Plaza (mining sluice). The Mountain Activity Sales office is the natural business unit within Telluride Ski and Golf to oversee the sales, fulfillment, and operations of the summer activities per our ongoing commitment to the marketing, communications, training, customer service and annual state of CO permitting requirements to operate.

We feel it imperative to maintain both the Spider Jump and mining sluice activities during spring and summer dates in order to foster a vibrant atmosphere in TMV's Heritage Plaza and further support the family-oriented activity demands of our summer guest demographic. The availability of these activities in line of sight and short walking distance from the Mountain Village Gondola Plaza draws ideal volumes of summer guests to businesses in the core, which in turn increases sales tax revenues for TMV and sales revenues for TMV merchants. We believe that maintaining the historical locations of the mining sluice and Spider Jump activities in Heritage Plaza and adjacent to Gondola Plaza on OS-3U promote economic, social, cultural, and entertainment values.

For all activities, we intend to deploy a similar approach to marketing the summer, adventure activities as we do with our winter lift access segments i.e. bi-weekly e-newsletter, geo-targeted social media ad campaigns, direct mail, summer tourism guide (TTB), etc... We are also working closely with Zoe Dohnal, J.D. Wise, and Katherine Warren at the TMV to provide as much synergy in the marketing and communication efforts for all summer activities available at the resort.

Our operational objectives detail a June 13, 2022 opening, with a 7 day operational schedule (9am – 5pm) through September 5, 2022 (Labor Day). After Labor Day, we will begin breaking down the activities and moving them off each respective location for fall/winter storage (off-site). Signage for each activity is based from historical standards utilizing existing resources from previous years with all sales stemming from the Mountain Activity Sales office located beneath the Mountain Village Gondola Plaza in what is the winter's lift ticket, pass, and ski school office.

Carson Taylor
Director | Mountain Sales

477903101036



4779031

OS 3U

TS

477903101035

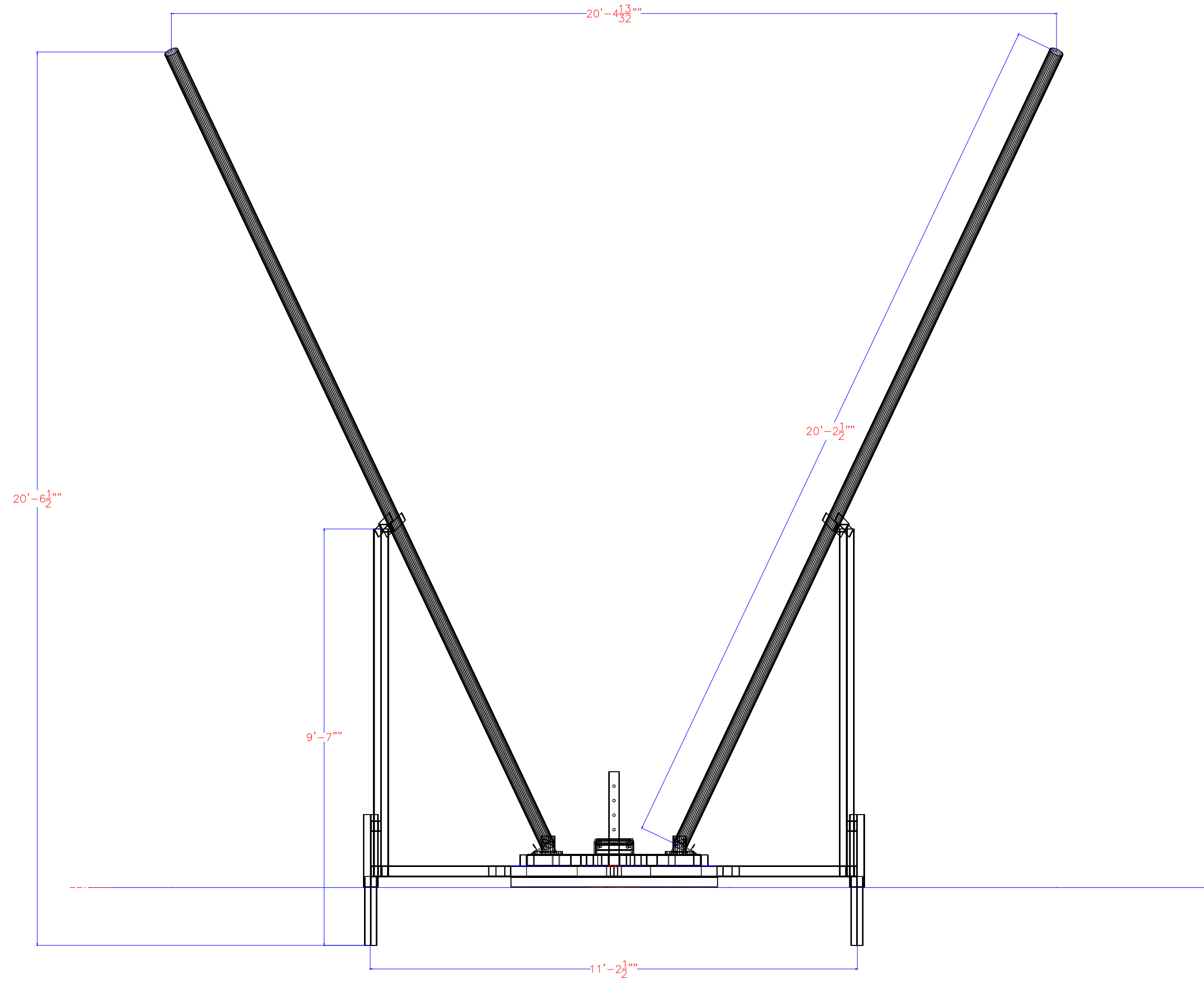

Revisions

Date:
00-00-0000

SPIDER JUMP

Drawn by: MATT PERRY

SHEET
A2

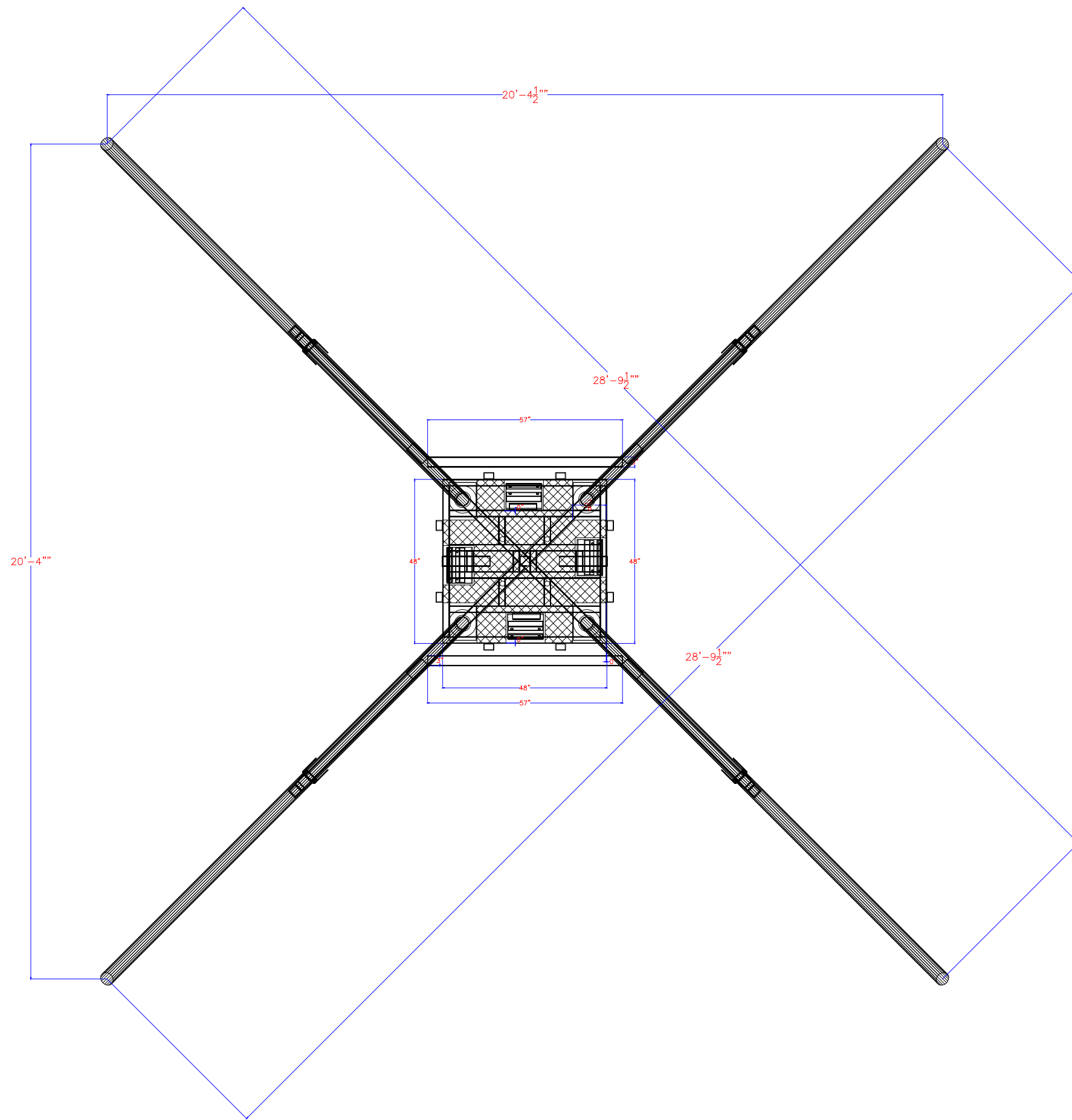

Revisions

Date:
00-00-0000

SPIDER JUMP

Drawn by: MATT PERRY

SHEET

A1

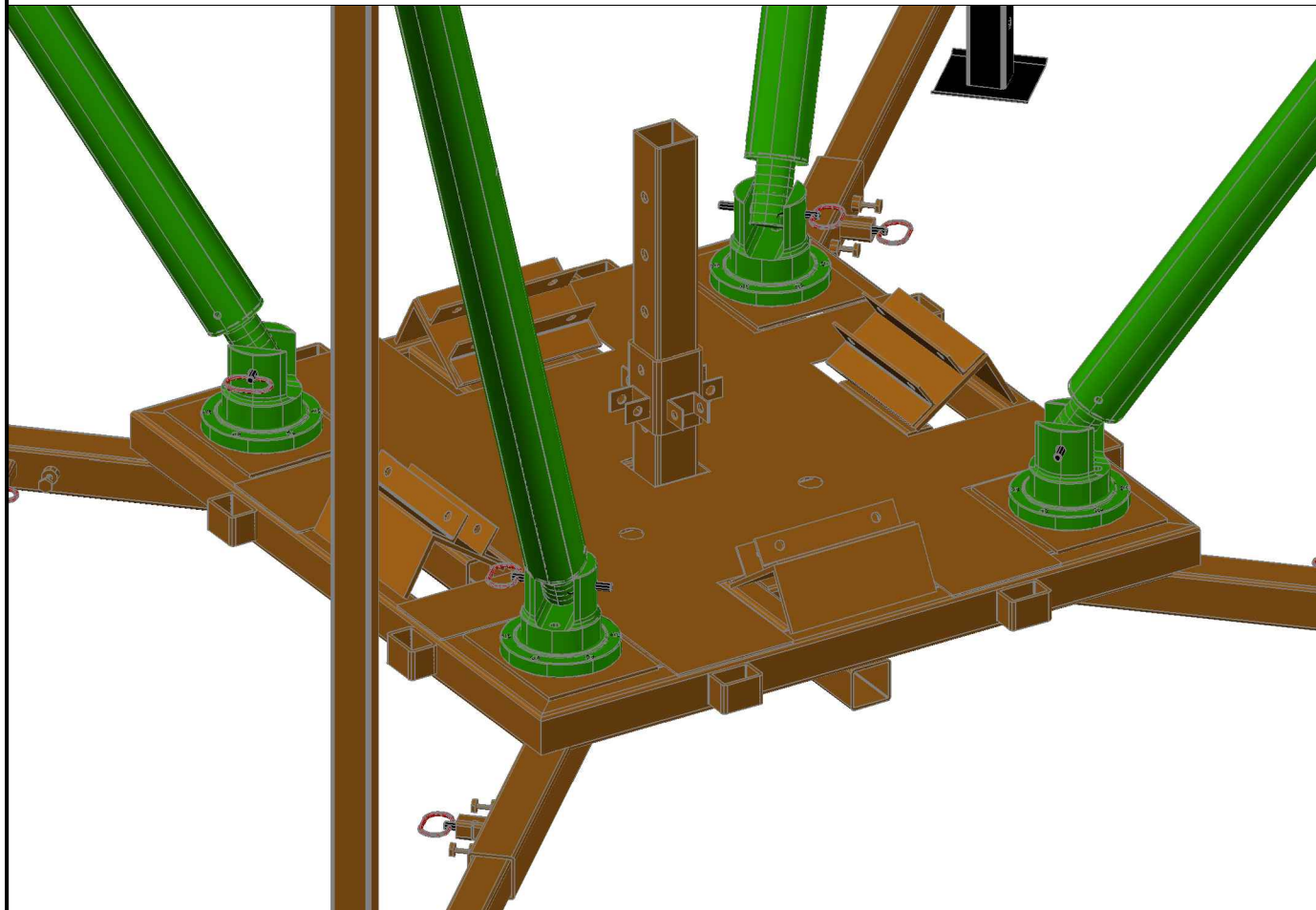
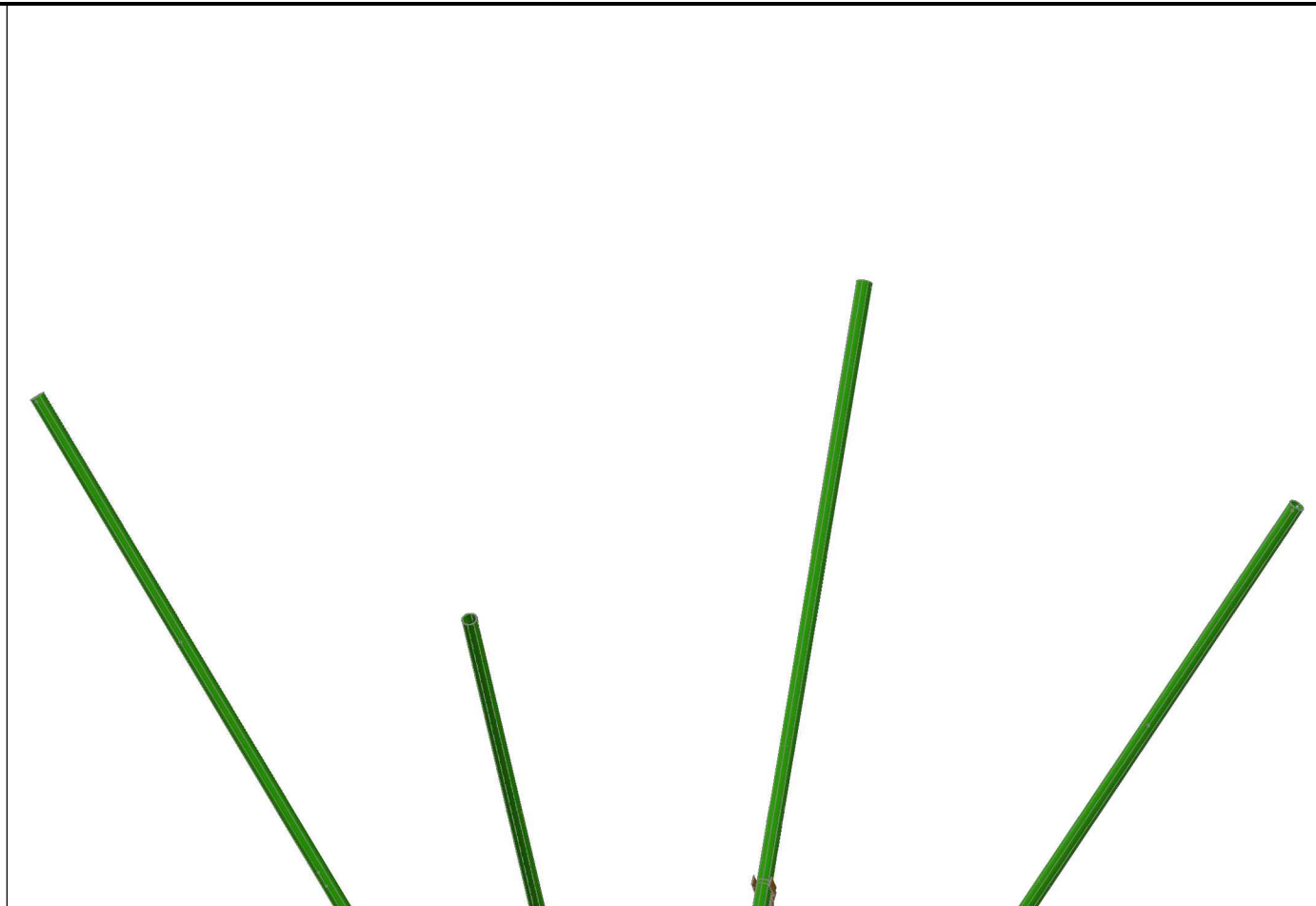
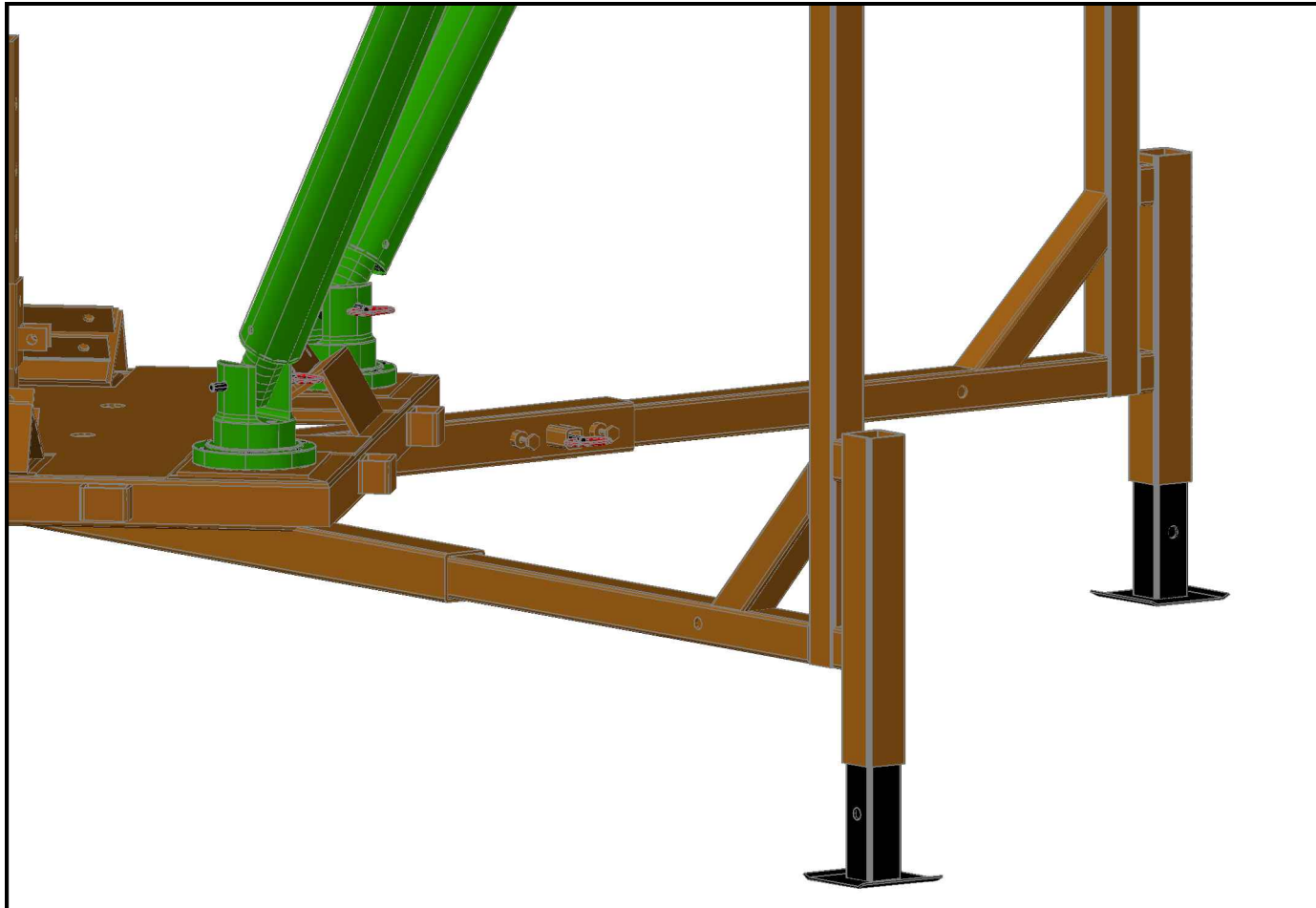

<u>Revisions</u>
Date:
00-00-0000

SPIDER JUMP	Drawn by: MATT PERRY
-------------	----------------------

SHEET
A3



From: [Randy Podolsky](#)
To: [Amy Ward](#)
Subject: Telski notice | summer activities
Date: Saturday, February 26, 2022 3:24:01 PM
Attachments: [Notice of Public Hearing on 3.17.22.pdf](#)

Amy,

Please accept my comment in support of this petition.

Vr
Randy

Randy D. Podolsky
Belvedere Park Condos-Phase One
Units 1,2,&3

iPhone. iTypos. iSorry

**RESOLUTION OF THE TOWN COUNCIL
OF THE TOWN OF MOUNTAIN VILLAGE,
MOUNTAIN VILLAGE, COLORADO
APPROVING A CONDITIONAL USE PERMIT FOR THE INSTALLATION OF A BUNGEE
TRAMPOLINE ACTIVITY AND A CANOPY TOUR TRAINING AREA ON ACTIVE OPEN
SPACE, OS-3U**

Resolution No. 2022-0421-__

- A. TSG Ski & Golf, LLC is the owner of record of real property described as Tract OS-3U, Town of Mountain Village (Owner); and
- B. The Owner has authorized Carson Taylor (Applicant) to pursue the approval of the Conditional Use Permit to allow for the installation of a Bungee Trampoline Activity and Canopy Tour Training Area on Tract OS-3U, and the Applicant has submitted such application requesting approval of the Conditional Use Permit; and
- C. The proposed development is in compliance with the provisions of Section 17.4.14 of the Community Development Code (CDC); and
- D. The Design Review Board (DRB) considered this application, along with evidence and testimony, at a public meeting held on April 21, 2022. Upon concluding their review, the DRB voted in favor of the Conditional Use Permit and recommended approval to the Town Council subject to certain conditions as set forth in this resolution; and
- E. The Town Council considered and approved this application, along with evidence and testimony, at a public meeting held on April 21, 2022; and
- F. The public hearings referred to above were preceded by publication of public notice of such hearings on such dates and/or dates from which such hearings were continued by mailing of public notice to property owners within four hundred feet (400') of the Property, as required by the CDC; and
- G. After the public hearings referred to above, the DRB and the Town Council each individually considered the Application submittal materials, and all other relevant materials, public letters and public testimony, and approved the Application with conditions as set forth in this Resolution; and
- H. The Applicant has addressed, or agreed to address, all conditions of approval of the Application imposed by Town Council based upon a recommendation for approval by the DRB; and
- I. The Town Council finds the Application meets the Conditional Use Permit requirements contained in CDC Section 17.4.14 as follows:
 - 1. The proposed conditional use is in general conformity with the policies of the principles, policies and actions set forth in the Comprehensive Plan;
 - 2. The proposed conditional use is in harmony and compatible with surrounding land uses and the neighborhood and will not create a substantial adverse impact on adjacent properties or on services and infrastructure;
 - 3. The design, development and operation of the proposed conditional use shall not constitute a substantial physical hazard to the neighborhood, public facilities, infrastructure or open space;

4. The design, development and operation of the proposed conditional use shall not have significant adverse effect to the surrounding property owners and uses;
5. The design, development and operation of the proposed conditional use shall not have a significant adverse effect on open space or the purposes of the facilities owned by the Town;
6. The design, development and operation of the proposed conditional use shall minimize adverse environmental and visual impacts to the extent possible considering the nature of the proposed conditional use;
7. The design, development and operation of the proposed conditional use shall provide adequate infrastructure;
8. The proposed conditional use does not potentially damage or contaminate any public, private, residential or agricultural water supply source; and
9. The proposed conditional use permit meets all applicable Town regulations and standards.

NOW, THEREFORE, BE IT RESOLVED THAT THE TOWN COUNCIL HEREBY APPROVES A CONDITIONAL USE PERMIT TO ALLOW FOR THE INSTALLATION OF A BUNGEE TRAMPOLINE ACTIVITY AND A CANOPY TOUR TRAINING AREA ON OS-3U AND AUTHORIZES THE MAYOR TO SIGN THE RESOLUTION SUBJECT TO CONDITIONS SET FORTH IN SECTION 1 BELOW:

1. The Applicant shall maintain adequate bike traffic access from the bottom of the bike park to the Village Center plazas by working with plaza services to explore the option of rerouting mountain bicyclists for the safety of ropes course attendees and trail users. Additional options include exploring a range of fencing materials.
2. The Applicant shall secure the structure, including, without limitation, the pool, ladders, and other elements that might attract public access when closed.
3. In the event of water limitations or restrictions, the Applicant shall close the pool portion of the ropes course structure.
4. The Applicant shall re-surface all disturbed areas with landscaping and provide seating for spectators.
5. The Applicant shall provide an erosion control and drainage plan to ensure protection of the wetlands in the surrounding area.
6. The applicant shall revise the site and grading plan to have appropriate finished grade material, benches and simple landscaping to improve the appearance of the ropes course, site grading and the existing condition of the site.
7. The Conditional Use Permit shall be valid for a period of three years (3) with an annual review by the Planning Division staff, with the applicant responding to any valid issues as they arise during operation or the annual review.

Be It Further Resolved that OS-3U may be developed as submitted in accordance with Resolution NO. 2022-0421-__

Approved by the Town Council at a public meeting April 21, 2022.

Town of Mountain Village, Town Council

By: _____
Laila Benitez, Mayor

Attest:

By: _____
Susan Johnston, Town Clerk

Approved as to Form:

David McConaughy, Town Attorney



Agenda Item No. 6
PLANNING & DEVELOPMENT SERVICE
PLANNING DIVISION
455 Mountain Village Blvd.
Mountain Village, CO 81435
(970) 728-1392

TO: Mountain Village Town Council and Design Review Board
FROM: Michelle Haynes, Planning and Development Services Director, Rachel Shindman EPS, Andrew Knudtsen EPS, Paul Wisor, Town Manager
FOR: Town Council Meeting of March 17, 2022 Continued to the April 21, 2022 Special DRB and Town Council meetings.
DATE: April 11, 2022
RE: A FIRST READING, SETTING OF A PUBLIC HEARING AND COUNCIL VOTE ON AN ORDINANCE REGARDING AMENDING CHAPTERS 16.01, 16.02, 17.3, AND 17.9 OF THE COMMUNITY DEVELOPMENT CODE CONCERNING AFFORDABLE HOUSING RESTRICTIONS AND ADOPTING HOUSING IMPACT MITIGATION REQUIREMENTS

Overview

The Town of Mountain Village, and the Telluride region as a whole, is in the midst of a housing crisis that directly threatens the quality of life of every Mountain Village resident, second homeowner, business, and visitor. From entry level restaurant workers to top level ski executives, and every other position in between, these critical roles are going unfilled, in large part, because such workers and their families lack viable housing options within or near Mountain Village. Unless this crisis is addressed, the basic services and amenities that make Mountain Village a place like no other, will be diminished or eliminated altogether.

Adoption of community housing mitigation directly addresses the impact new construction has on the associated housing need generated by new development. Housing would then be satisfied through built units, payments or within a hierarchy of approaches to satisfy the requirement acceptable to the town.

In June of 2021, the Town of Mountain Village issued a request for proposal (RFP) to hire a firm to generate a linkage study and proposed community housing mitigation formula for community housing mitigation requirements generated by new construction.

What would result is a study, a housing mitigation rate for payment in lieu, a hierarchy of desired mitigation, a housing mitigation worksheet and an update to our housing guidelines. Our primary focus as explained in the RFP, is developing the linkage and rate for commercial, lodging, and multi-family new construction. Secondly, single family new construction.

We hired Economic Planning Systems and RRC Associates which have been creating such linkage studies and reports for decades with specific expertise working with Colorado mountain communities.

The intent of this program is to create a simple methodology that is easy to understand and apply both for the developer and administration.

The ordinance is a culmination of a series of data collection, analysis and worksessions with Town Council. This item was continued from the March 17, 2022 special joint meeting between the DRB and Town Council.

HISTORY OF WORKSESSIONS

- December 16, 2021 Town Council worksession [click here to watch the worksession](#)
- January 20, 2022 Town Council worksession [click here to watch the worksession](#)
- February 17, 2022 Town Council worksession [click here to watch the worksession](#)

ATTACHMENTS

1. Ordinance
2. Community Housing Mitigation PowerPoint from 3.17.22
3. Community Housing Mitigation Worksheet dated 3.10.22
4. Technical Memo from EPS dated 3.10.22
5. Attorney Memo dated 3.10.22
6. Town Council packet item from December 16, 2021
7. Public Comment Pearson received, 4.5.22

COMMUNITY HOUSING MITIGATION METHODOLOGY WORKSHEET

This program is recommended to apply to all commercial and residential development, including new construction and additions.

Employee Generation Rates

Based on the nexus analysis completed by EPS and RRC, the following employee generation rates are recommended:

General Commercial	2.0 employees per 1,000 square feet
Hotel/Accommodation	0.50 employees per room
Multifamily Residential	0.19 employees per unit
Single Family Residential	0.12 employees per 1,000 square feet

A detailed summary of this analysis is provided in the nexus study technical memo attached as exhibit #3.

Mitigation Rate

The nexus study outlines the maximum level of housing need that a developer can be required to mitigate; in practice, policies will generally require less than 100 percent of this need to be mitigated. The recommendation is to set mitigation rates to be consistent with the historic position of the region, at 40 percent for commercial development (general commercial and hotel/accommodation) and 60 percent for residential development (multifamily and single family).

Mitigation Methods

There are three recommended methods of mitigating the housing need generated: (1) provide units within the Town of Mountain Village, (2) provide units outside the Town of Mountain Village but within the region defined as the SMART transportation route, and (3) pay a fee-in-lieu of providing units.

Recognizing that the Town's goal is to increase the inventory of units, an incentive structure is recommended to prioritize the provision of units over paying a fee-in-lieu. Under this structure, developers who provide units within the Town would receive a 30 percent discount on their mitigation requirement (e.g. if a fee-in-lieu would have to be paid for 1,000 square feet of employee housing, only 700 square feet would have to be provided on site); developers who provide units outside of Town would receive a 15 percent discount (on that same 1,000 square foot requirement, they would need to provide 850 square feet of housing); those paying the fee-in-lieu would not receive a discount (would pay based on the full mitigation requirement of 1,000 square feet).

DRB RECOMMENDATION

The DRB provided a recommendation on April 21, 2022 and this will be reported out verbally at the Council meeting due to the recommendation being provided for after packet deadline.

ADDITIONAL INFORMATION

Town Council made a series of decisions to inform the mitigation worksheet that are generally summarized below:

- The town proposes to adopt a 40% mitigation rate for commercial and a 60% mitigation rate for residential.
- The cost per square foot mitigation rate is established as **\$606** a square foot.
- The town agrees to graduate the mitigation requirements over the next four years. We apply the worksheet and then reduce it by the following percentages:
 - Year 1: Apply 25% of the mitigation requirement
 - Year 2: Apply 50% of the mitigation requirement
 - Year 3: Apply 75% of the mitigation requirement
 - Year 4 and thereafter: Apply 100% of the mitigation requirement
- Town Council established a preferred hierarchy. Within the mitigation worksheet, there is a reduced mitigation requirement if deed restricted housing is built onsite versus a payment.
- Council gave general direction that they liked this hierarchy and the general philosophy to incentivize built onsite units and provide less incentive as you move farther down the list. The mitigation worksheet implements the following three means to satisfy the mitigation requirement.
 - 1) Build in town and/or onsite
 - 2) ~~Build offsite within the town~~
 - 3) Build ~~offsite within the region~~ out of town
 - 4) ~~Deed Restrict free market inventory~~
 - 5) 4) Payment in lieu
 - 6) ~~Conveyance of land~~
- Town Council determined the mitigation requirements would apply to mixed use development this means new commercial, new multi-family residential and new Village Center development.

- Town Council direction is needed as to whether to apply the mitigation methodology to new single-family development. This is provided for in the mitigation worksheet.
- Town Council agreed to provide a provision to allow for an independent mitigation calculation for non-profit entities or those that can otherwise demonstrate a reduced generation rate. (e.g. a grocery store has a lot of floor area mostly used for inventory and storage with a lower employee generation that could be demonstrated via an independent calculation.)-

MUNICIPAL CODE CHANGES

CDC CHANGES

SUMMARY

We have provided edits to the CDC and the Municipal code in order to adopt the mitigation methodology and conform terms.

RECOMMENDED MOTION TOWN COUNCIL

I MOVE TO APPROVE AN ORDINANCE ON FIRST READING OF THE TOWN COUNCIL OF THE TOWN OF MOUNTAIN VILLAGE, COLORADO AMENDING CHAPTERS 16.01, 16.02, 17.3, AND 17.9 OF THE COMMUNITY DEVELOPMENT CODE CONCERNING AFFORDABLE HOUSING RESTRICTIONS AND ADOPTING HOUSING IMPACT MITIGATION REQUIREMENTS AND ASK THE TOWN CLERK TO SET A PUBLIC HEARING FOR MAY 19, 2022.

/mbh

ORDINANCE NO. 2022-__

**AN ORDINANCE OF THE TOWN COUNCIL OF THE TOWN OF MOUNTAIN VILLAGE,
COLORADO AMENDING CHAPTERS 16.01, 16.02, 17.3, AND 17.9 OF THE COMMUNITY
DEVELOPMENT CODE CONCERNING AFFORDABLE HOUSING RESTRICTIONS AND
ADOPTING HOUSING IMPACT MITIGATION REQUIREMENTS**

WHEREAS, the Town of Mountain Village (“Town”) is a home rule municipality duly organized and existing under Article XX of the Colorado Constitution and the Town of Mountain Village Home Rule Charter of 1995, as amended (“Charter”); and

WHEREAS, pursuant to Charter Section 3.6(b), the Town Council of the Town of Mountain Village (the “Town Council”) has the authority to establish land use standards to provide for the present and future needs of the Town;

WHEREAS, Chapters 16.01 and 16.02 of the Mountain Village Municipal Code provide restrictions on affordable housing, Title 17 of the Municipal Code is known as the Town of Mountain Village Community Development Code (“CDC”), Chapter 17.3 of the CDC outlines zoning and land use regulations including workforce housing requirements, and Chapter 17.9 of the CDC is the Appendix containing maps, graphs, and worksheets related to CDC regulations; and

WHEREAS, development and construction of free-market residential housing, hotels, and commercial establishments creates impacts and burdens on the Town and its citizens including, among other things, maintaining adequate levels of public facilities, funding necessary capital improvements, and providing affordable and attainable housing for workers and local residents; and

WHEREAS, the Town engaged consultants to study the impacts of development and to recommend a methodology to require mitigation of housing impacts through construction of new housing and/or to establish, collect, and use housing impact fees under certain circumstances to address such impacts and burdens, the results of which are outlined in the Housing Mitigation Linkage Fee Nexus Analysis, dated March 9, 2022; and

WHEREAS, in compliance with Section 17.1.7 of the Mountain Village Municipal Code, the Town’s Design Review Board reviewed the analysis and provided a recommendation to Town Council on _____, 2022; and

WHEREAS, based on the Design Review Board’s recommendation and public comments, the Town Council desires to amend the CDC and adopt housing impact mitigation requirements to address the demand for affordable housing created by new free-market development as set forth below.

NOW, THEREFORE, BE IT ORDAINED BY THE TOWN COUNCIL OF THE TOWN OF MOUNTAIN VILLAGE, COLORADO, as follows:

Section 1. Recitals. The above recitals are hereby incorporated as findings of the Town Council in support of the enactment of this Ordinance.

Section 2. Amendments to CDC. The Town Council hereby amends the CDC as follows:

A. Section 17.9.7 is hereby added to Chapter 17.9 to include Appendix 17-3, Town of Mountain Village Affordable Housing Mitigation Calculator.

B. Chapters 16.01, 16.02, and 17.3 are hereby amended as set forth in Exhibit A, attached hereto.

Section 3. Severability. If any portion of this Ordinance is found to be void or ineffective, it shall be deemed severed from this Ordinance and the remaining provisions shall remain valid and in full force and effect.

Section 4. Safety Clause. The Town Council hereby finds, determines, and declares that this Ordinance is promulgated under the general police power of the Town, that it is promulgated for the health, safety, and welfare of the public, and that this Ordinance is necessary for the preservation of health and safety and for the protection of public convenience and welfare. The Town Council further determines that the Ordinance bears a rational relation to the proper legislative object sought to be obtained.

Section 5. Effective Date. This Ordinance shall become effective on _____, 2022 and shall be recorded in the official records of the Town kept for that purpose and shall be authenticated by the signatures of the Mayor and the Town Clerk.

Section 6. Public Hearing. A public hearing on this Ordinance was held on the ___ day of _____, 2022 in the Town Council Chambers, Town Hall, 455 Mountain Village Blvd., Mountain Village, Colorado 81435.

Section 6. Publication. The Town Clerk or Deputy Town Clerk shall post and publish notice of this Ordinance as required by Article V, Section 5.8 of the Charter.

INTRODUCED, READ AND REFERRED to public hearing before the Town Council of the Town of Mountain Village, Colorado on the ___ day of _____, 2022

TOWN OF MOUNTAIN VILLAGE:

**TOWN OF MOUNTAIN VILLAGE, COLORADO,
A HOME-RULE MUNICIPALITY**

By: _____
Laila Benitez, Mayor

ATTEST:

Susan Johnston, Town Clerk

HEARD AND FINALLY ADOPTED by the Town Council of the Town of Mountain Village, Colorado this ___ day of _____, 2022

TOWN OF MOUNTAIN VILLAGE:

**TOWN OF MOUNTAIN VILLAGE, COLORADO,
A HOME-RULE MUNICIPALITY**

By: _____
Laila Benitez, Mayor

ATTEST:

Susan Johnston, Town Clerk

Approved as to Form:

David McConaughy, Town Attorney

I, Susan Johnston, the duly qualified and acting Town Clerk of the Town of Mountain Village, Colorado ("Town") do hereby certify that:

1. The attached copy of Ordinance No. 2022-__ ("Ordinance") is a true, correct, and complete copy thereof.
2. The Ordinance was introduced, read by title, approved on first reading and referred to public hearing by the Town Council the Town ("Council") at a regular meeting held at Town Hall, 455 Mountain Village Blvd., Mountain Village, Colorado, on _____, 2022, by the affirmative vote of a quorum of the Town Council as follows:

Council Member Name	"Yes"	"No"	Absent	Abstain
Laila Benitez, Mayor				
Dan Caton, Mayor Pro-Tem				
Marti Prohaska				
Harvey Mogenson				
Patrick Berry				
Peter Duprey				
Jack Gilbride				

3. After the Council's approval of the first reading of the Ordinance, notice of the public hearing, containing the date, time and location of the public hearing and a description of the subject matter of the proposed Ordinance was posted and published in the Telluride Daily Planet, a newspaper of general circulation in the Town, on _____, 2022 in accordance with Section 5.2(d) of the Town of Mountain Village Home Rule Charter.
4. A public hearing on the Ordinance was held by the Town Council at a regular meeting of the Town Council held at Town Hall, 455 Mountain Village Blvd., Mountain Village, Colorado, on _____, 2022. At the public hearing, the Ordinance was considered, read by title, and approved without amendment by the Town Council, by the affirmative vote of a quorum of the Town Council as follows:

Council Member Name	"Yes"	"No"	Absent	Abstain
Laila Benitez, Mayor				
Dan Caton, Mayor Pro-Tem				
Marti Prohaska				
Harvey Mogenson				
Patrick Berry				
Peter Duprey				
Jack Gilbride				

5. The Ordinance has been signed by the Mayor, sealed with the Town seal, attested by me as Town Clerk, and duly numbered and recorded in the official records of the Town.

IN WITNESS WHEREOF, I have hereunto set my hand and affixed the seal of the Town this ___ day of _____, 2022.

 Susan Johnston, Town Clerk
 (SEAL)

Exhibit A

Chapter 16.01 1997 EMPLOYEE HOUSING RESTRICTION

16.01.010 Purpose.

This Chapter shall govern the ownership, use and occupancy of Affordable Housing in the Town, ~~including all “Employee Apartment” and “Employee Dormitory” dwelling units (defined on the Official Town Plat) which were created prior to September 8, 2006. This Chapter shall also apply to all development which has contractually agreed to abide by the regulations contained herein.~~

Chapter 16.02 2006 EMPLOYEE HOUSING RESTRICTION

16.02.010 Purpose.

B. As of ~~the~~ September 8, 2006, this Chapter shall govern the ownership, use and occupancy of Affordable Housing Units and Affordable Housing Lots ~~(as defined in Sections 11.3.a. and 3.b., respectively)~~ in the Town, which are created or purchased (with the buyer’s agreement) after September 8, 2006. This Chapter shall also apply to all development which has contractually agreed to abide by the regulations contained herein.

16.02.060 Initial Sales of Affordable Housing.

A. 1. The initial sales price of Affordable Housing Units sold by the multi unit developer ~~shall be no greater than \$250 per square foot. may be adjusted by The Town of Mountain Village Town Council may adjust this initial per square foot sales price annually by annual resolution of the Town Council.~~ at its discretion. ~~Square footage shall be measured from the interior demising walls.~~

16.02.070 Resale of Affordable Housing Including Appreciation Limits.

B. Resale of Affordable Housing Units and Affordable Housing Lots shall be to qualified buyers as governed by Sections ~~F of this Ordinance~~ 16.02.080 and 16.02.100.

C. The sales price for resale of an Affordable Housing Unit or Affordable Housing Lot ~~shall be calculated by allowing a 3% appreciation, compounded annually, may be capped to a certain percentage of appreciation~~ of the initial purchase price paid by the Owner, from the purchase date by the Owner, ~~as set by annual resolution of the Town Council, in its discretion.~~

D. ~~The 3%~~Any percentage of appreciation will be prorated to the day when the notice of intent to sell the unit is received by the Housing Authority or its designee.

Chapter 17.3 ZONING AND LAND USE REGULATIONS

17.3.9 ~~Workforce~~ Housing Impact Mitigation Requirements.

~~A. Lots or dwelling units with employee apartment, employee condominium, employee single family or employee dorm zoning designations (collectively “workforce housing”) are restricted to occupancy exclusively by persons who are employed within the Telluride R-1 District and their spouses and children.~~

A. Purpose. The purpose of this Section is to help provide housing that is affordable and attainable for persons who are employed within the Telluride R-1 School District, the demand for which is created by new free-market development. This is accomplished through the establishment of the housing impact mitigation requirements for new development that requires the production of Affordable Workforce Housing Units in the Town, outside of the Town, or, as a less preferred alternative, cash payments.

B. Applicability. The requirements of this Section apply to all new commercial and residential development within the incorporated limits of the Town as defined below. This Section also applies to a change of use that generates new employees.

C. Definitions. For the purposes of this Section, the following definitions shall apply:

~~“Affordable housing” means residential lots and dwelling units restricted by deed to use and occupancy by persons who are employed within the Telluride R-1 School District and their spouses and children. This term is synonymous with “workforce housing” as it is used elsewhere in this Chapter and throughout the CDC.~~

~~“Affordable Housing Restriction” means the deed restriction placed on Affordable Housing Units constructed pursuant to this Section. This term includes Employee Housing Restriction or Affordable Housing Restriction as used in Chapters 16.01 and 16.02, respectively.~~

~~“Affordable Housing Units” means dwelling units with Employee Apartment, Employee Condominium, Employee Dormitory, and Employee Single Family zoning designations which are deed restricted to occupancy by persons who are employed within the Telluride R-1 School District and their spouses and children.~~

“Commercial development” means any development involving the use of premises (land and building) for the purpose of conducting business, including but not limited to retail stores, restaurants, shopping centers, business offices, gas stations, hotels, motels and other accommodation, industrial uses and all other non-residential development. This term does not include Municipal Facilities as defined in Section 17.8.1.

~~“Employee” means a person who is employed or can show intent to be employed within the Telluride R-1 School District and maintains Residence in the Town. The Housing Authority, or its designee, shall determine whether a person qualifies as an Employee based on criteria including evidence of income earned within the Telluride R-1 School District, place of voter registration, place of automobile registration, driver’s license address, income tax records and public service involvement within the Telluride R-1 School District community. A person not otherwise meeting the definition of employee may be qualified as an Employee by staff if that person is more than sixty (60) years of age and has been employed in the Telluride R-1 School District. Determination of Employee eligibility by the staff may be appealed to the Town Council.~~

“Residential development” means any development intended for primary use as a residence, including but not limited to attached and detached single-family dwellings, apartments, condominiums, townhouses, and cottages, and their associated outbuildings such as accessory dwelling units. This term does not include Affordable Workforce Housing Units.

~~“Workforce Housing” means residential lots and dwelling units restricted by deed to use and occupancy by Employees and their spouses or domestic partners and children. This term is synonymous with “affordable housing” as used in Title 16 and throughout the CDC.~~

~~“Workforce Housing Restriction” means the deed restriction placed on Workforce Housing Units constructed pursuant to this Section. This term includes Employee Housing Restriction and Affordable Housing Restriction as used in Chapters 16.01 and 16.02, respectively.~~

~~“Workforce Housing Units” means dwelling units with Employee Apartment, Employee Condominium, Employee Dormitory, or Employee Single-Family zoning designations which are deed-restricted to occupancy by Employees and their spouses or domestic partners and children.~~

D. Calculation of Housing Impact Mitigation Requirements. As of the effective date of Ordinance No 2022-x, for all new commercial and residential development within the Town, the developer shall be required to mitigate the housing impacts of said development either by providing AffordableWorkforce Housing Units or paying a fee in lieu in accordance with Appendix 17-3 Town of Mountain Village Affordable Housing Mitigation Calculator in Section 17.9.7 (“Mitigation Worksheet”).

1. With a land use application for new commercial or residential development, the developer shall provide a completed Mitigation Worksheet. The developer shall decide whether to provide the AffordableWorkforce Housing Units or make the payment-in-lieu, or some combination thereof.

a.. If the developer elects to make the payment-in-lieu, such payment is due upon submission of a building permit application.

b. If the developer elects to provide AffordableWorkforce Housing Units on the same site as the proposed commercial or residential development, the developer shall include the AffordableWorkforce Housing Units in the same building permit application as the proposed development.

c. If the developer elects to provide AffordableWorkforce Housing Units off-site, either in the Town or outside of the Town limits, the developer shall submit a separate building permit application for the AffordableWorkforce Housing Units.

i. If the developer elects to provide Workforce Housing Units off-site but “in the Town,” such units shall be located within the incorporated limits of the Town of Mountain Village.

ii. If the developer elects to provide Workforce Housing Units off-site but “outside of the Town limits,” such units shall be located within the boundaries of the San Miguel Authority for Regional Transportation (“SMART”) service areas.

2. Compliance with the requirements of this Section shall be a condition of issuance of a building permit for the proposed development.

a. The developer shall secure a certificate of occupancy for the AffordableWorkforce Housing Units prior to or concurrent with the certificate of occupancy for the proposed development.

3. Housing mitigation and fees in lieu calculated pursuant to the Mitigation Worksheet shall be phased in as follows:

a. If a land use application is submitted on or before December 31, 2022, the developer shall be required to meet 25% of the housing mitigation and/or fees in lieu.

b. If a land use application is submitted between January 1, 2023 and December 31, 2023, the developer shall be required to meet 50% of the housing mitigation and/or fees in lieu.

c. If a land use application is submitted between January 1, 2024 and December 31, 2024, the developer shall be required to meet 75% of the housing mitigation and/or fees in lieu.

d. Any land use applications submitted on or after January 1, 2025 shall be required to meet 100% of the housing mitigation and/or fees in lieu.

4. The requirements of this Section shall not apply to development projects for which building permits have been issued as of the effective date of Ordinance No. 2022-x.

5. Town Council may amend the Mitigation Worksheet, by resolution, from time to time but no more than annually.

E. Exemptions. The following development shall be exempt from the requirements of this Section:

1. Municipal Facilities as defined in Section 17.8.1;

2. Affordable Workforce Housing Units created pursuant to this Section and other pre-existing deed-restricted housing;

3. Redevelopment of pre-existing use and change in use provided such activity does not generate new employees;

4. Non-profit and volunteer-based organizations providing community benefits provided the developer can demonstrate the new development shall not generate new employees;

If any developer believes that a particular development generates fewer employees than provided for in the Mitigation Worksheet, the developer may make a request to Town Council for an exemption or reduction in the requirements and provide evidence demonstrating that the proposed development will generate fewer employees than expected pursuant to the Mitigation Worksheet. The Town Council shall have sole discretion to determine whether any exemption or reduction shall be applied based on the evidence presented on a case-by-case basis and without creating binding precedent for any future project.

B.F. Deed Restriction. ~~Workforce~~ Any Affordable Workforce Housing Units constructed pursuant to this Section shall be required to enter into an ~~Workforce Affordable Housing Restriction on agreement~~ restricting use, zoning and occupancy of the units with the Town, such as a Workforce Housing Restriction, that will constitute a covenant that runs in perpetuity as a burden thereon and shall be binding on the owner and on the heirs, personal representatives, assigns, lessees, licensees and any transferee of the owner.

1. The form and content of the ~~Workforce Affordable Housing Restriction~~ or like agreement shall be reviewed and approved by ~~the~~ Town by resolution and may be amended by resolution from time to time. Council based and may be modified based on project-specific concerns at the discretion of Council.

~~2. Each lot or development that must provide workforce housing shall be subject to the workforce housing restriction in effect at the time of submitting a development or redevelopment application.~~

3. The ~~Workforce Affordable Housing Restriction~~ or like agreement shall be executed and recorded prior to the issuance of any certificate of occupancy.

~~4. For workforce housing developed after the effective date of the CDC, the workforce housing restriction shall run with the property in perpetuity and shall not be lost in the event of foreclosure.~~

~~5. For workforce housing developed prior to the effective date of this CDC, the old duration of the workforce housing restriction and covenant ran for an initial period of fifty (50) years and, at the option of the Town Council or its designee, may be extended for an additional period of fifty (50) years after public hearing and comment on the proposed extension.~~

6.3. The ~~Workforce Affordable Housing Restriction~~ and covenant or like agreement shall be administered by the Town, or its designee, and shall be enforceable by any appropriate legal or

equitable action including, but not limited to specific performance, injunction, abatement or eviction of noncomplying owners, users or occupants or such other remedies and penalties as may be provided by Colorado law or the ordinances of the Town.

~~E.G.~~ Density. Certain Lots that are required to construct and provide Workforce Affordable Housing Units concurrent with the free-market development allowed on a lot. ~~Such lots with workforce housing~~ are designated on the official land use and density allocation list.

1. Workforce Affordable housing density assigned to a lot on the official land use and density allocation list or by an effective resolution shall be built concurrent with any free-market units on that lot, and workforce affordable housing density cannot be transferred to the density bank or to another lot unless the Town Council determines, in its sole discretion, that the workforce affordable housing density cannot be built on a site due to a practical hardship.

a. If the Town Council determines a practical hardship exists, the applicant shall be required to transfer the unbuilt workforce affordable housing density to the density bank pursuant to the rezoning and density transfer processes.

b. The owner of workforce affordable housing density shall be responsible for all dues, fees and any taxes associated with that density and zoning until such time as the density is transferred to a lot pursuant to the rezoning and density transfer process.

~~D.H.~~ Compliance with Comprehensive Plan. The Comprehensive Plan also identifies the need to provide workforce affordable housing as a part of the development of certain parcels as shown in each subarea plan's development table. Such workforce affordable housing shall be developed in accordance with the Comprehensive Plan policies and be subject to the Workforce Affordable Housing Restriction.

~~E.I.~~ Pre-existing Deed Restrictions. Lots that were developed prior to the effective date of the CDC ~~shall~~ bear subject to the ~~workforce housing deed~~ restriction in effect on the property unless ~~a~~ the property owner elects to convert to a newer Workforce affordable Housing Restriction.

1. Workforce Affordable housing developed prior to the effective date of the CDC is subject to ~~an~~ employee Affordable Workforce Housing Restriction that has a provision that removes the deed restriction upon foreclosure by a Public Trustee in accordance with Section 16.01.120.

2. Even if the Workforce Affordable Housing Restriction is removed upon foreclosure, a rezoning is required to change the zoning designation from ~~an~~ employee affordable workforce housing designation to a free-market zoning designation.

3. During the review of any zoning amendment that involves a foreclosed Workforce Affordable Housing Unit that has a deed restriction that is effectively removed upon foreclosure, the Town shall determine if the workforce affordable housing density assigned to the lot was a part of the original density in the Density Limitation or if such is considered workforce affordable housing bonus density that was granted after the Town's incorporation. If it is workforce affordable housing bonus density, the Town Council may in its sole discretion either deny a zoning amendment because the change to a free-market unit would increase the Density Limitation, or require the applicant to transfer the needed density from the density bank or another lot prior to approving the ordinance approving the zoning amendment. Any denial of a rezoning in this situation shall allow the continuation of the ~~employee affordable workforce~~ housing zoning designation as an unrestricted free-market unit since such is not encumbered by a deed restriction.

4. Free-market housing may only be allowed on active open space in the event that the ~~employee~~ Affordable Workforce Housing ~~deed R~~estriction is terminated in the event of foreclosure by the

holder of the promissory note secured by a first deed of trust (other private seller financing) on an ~~an~~ ~~W~~workforce ~~Affordable-H~~ousing ~~U~~unit and subject to the issuance of a public trustee's or sheriff's deed to the holder of the promissory note or governmental agency guaranteeing, insuring, or acquiring the promissory note from the holder.

a. In the event of the foreclosure of an ~~an~~ ~~W~~workforce ~~Affordable-H~~ousing ~~U~~unit located on a lot zoned as active open space, the Town Council shall not rezone such to a non-open space zone district and/or to another non-workforce ~~affordable~~ housing zoning designation unless:

i. The applicant provides Replacement Open Space that is deed restricted in perpetuity; and,

ii. The applicant transfers density from the density bank for the unit to ensure the Density Limitation is not exceeded by the rezoning.

5. Workforce ~~Affordable-H~~ousing ~~U~~units pay half the tap fee of a free-market unit. ~~Therefore,~~ any foreclosure action that results in a rezoning development application to a free-market condominium shall only be approved by the Town if the full tap fee is paid.

COMMUNITY HOUSING MITIGATION STUDY

Design Review Board

Town Council

March 17, 2022



PROJECT OVERVIEW

RESIDENTIAL AND COMMERCIAL LINKAGE STUDIES

What is this effort?

- Generated linkage program components
 - Employee generation
 - Affordability gap
 - Mitigation requirements
- Created policy implementation tool
 - Interactive worksheet

Why do this type of work?

- New development generates local employment
- Many of these local employees struggle to afford housing
- Linkage programs “link” the need generated by new development to an obligation for the developer to provide an amount of housing to mitigate the new need

Who else is doing this?

- Common approach, particularly in mountain resort communities
- Telluride, CO
- Vail, CO
- Aspen, CO
- Mt. Crested Butte, CO
- Jackson, WY

PROJECT OUTCOMES

- Program components
 - Employee generation rates – commercial and residential
 - Mitigation rate
 - Mitigation methods
 - Fee-in-lieu (locally calibrated)

- Implementation worksheet

- Program was structured through consultation with Council and staff
 - Determined development that is subject to the policy, methods for mitigation, mitigation rate
 - Proposed program reflects Council direction from previous work sessions



INSTRUCTIONS

1. Input project details and size for relevant development type(s) in green boxes
2. Resultant required housing mitigation/fee-in-lieu can be found in yellow boxes (total) and blue boxes (by mitigation type) (Note that blue boxes represent mitigation required if all requirement is mitigated using that method)
3. Enter amount of housing to be mitigated/fee to be paid by mitigation type in green boxes
4. Ensure total mitigation amount, accounting for all types, totals 100% of requirement

1. PROJECT & APPLICANT

Project Title	<input type="text"/>	Project Address	<input type="text"/>
Applicant Name	<input type="text"/>	Applicant Address:	<input type="text"/>
Applicant Phone	<input type="text"/>	Applicant Email	<input type="text"/>
Date	<input type="text"/>		

Net floor area of commercial space proposed:	<input type="text"/>	sq. ft.
Number of hotel/accommodation units proposed:	<input type="text"/>	units
Number of free market multifamily residential units proposed:	<input type="text"/>	units
Number of free market single family residential units proposed:	<input type="text"/>	sq. ft.

2. CALCULATION OF MINIMUM AFFORDABLE HOUSING REQUIREMENTS

For commercial/public facility uses:
 \times 2.00 employees / 1,000 sq.ft. \times 400 sq.ft./employee \times 40% mitigation = sq. ft. employee housing
net space increase (sq. ft.)

For hotel and accommodation uses:
 \times 0.50 employees / unit \times 400 sq.ft./employee \times 40% mitigation = sq. ft. employee housing
number of lodging units

For multi-family residential and mixed-use residential uses:
 \times 0.19 employees / unit \times 400 sq.ft./employee \times 60% mitigation = sq. ft. employee housing
number of dwelling units

For single family residential uses:
 \times 0.12 employees / 1,000 sq.ft. \times 400 sq.ft./employee \times 60% mitigation = sq. ft. employee housing
net space increase (sq. ft.)

TOTAL MINIMUM AFFORDABLE HOUSING REQUIREMENT = sq. ft. employee housing

A TOOL IN THE TOOLBOX

In conjunction with this linkage program, and through the implementation of the Comprehensive Plan, Council will begin to consider a variety of additional tools to address housing needs. Housing tools generally fall into 3 categories:

Construction

Creating new units of local/affordable housing

Projects may include development of local sites or elsewhere in the region

Funding

Generating new revenue for housing initiatives

Revenue streams may include linkage fee-in-lieu, short term rental fee, general fund set aside, etc

Programs

Various programs to deploy funds in ways to expand the housing supply

Programs may include those considered within Community Housing Initiatives

PROGRAM OVERVIEW

PROGRAM COMPONENTS

Analysis/Data Based

- Employee generation
 - For every X square feet/units of net new development, Y employees are generated
- Mitigation requirement (100%)
 - For the Y employees generated, there is a need for Z square feet of affordable housing
 - Accounts for income levels of employees
- Fee-in-Lieu
 - Based on affordability needs, a fee of \$____ will mitigate the affordability gap generated

Policy Based

- Mitigation methods
 - How can developers mitigate the housing need generated by their development?
 - Two broad categories
 - Units (construct or acquire/buy down)
 - Resources (land or money)
- Mitigation rate
 - How much of the housing need generated is the developer's responsibility to mitigate, and how much is a community obligation?

FACTORS WITHIN POLICY

KEY COMPONENTS AND CONSIDERATIONS

1. Employee Generation Rates



Locally calibrated, and around half of those found in Telluride

2. Financial Gaps

- Demand factors
 - Wages
- Supply factors
 - Market valuation of all housing



When all financial gaps are considered, and using a market valuation approach, about ¼ higher than Telluride

3. Mitigation Rates



Benchmark at the historic Telluride mitigation rates, 40% commercial and 60% residential

4. Incentive structure to encourage construction



Reduce requirements if developers willing to 'go vertical'

MIXED USE

Description	Factor		Result
MIXED USE			
A. New Development			
Commercial	<i>square feet</i>		10,000
Hotel	<i>rooms</i>		50
Multifamily	<i>units</i>		30
B. Employees Generated			
Commercial	2.0	<i>per 1,000 sq. ft.</i>	20.0
Hotel	0.50	<i>per room</i>	25.0
Multifamily	0.19	<i>per unit</i>	5.7
Total			50.7
C. Housing Need Generated			
Commercial	400	<i>sq. ft. per employee</i>	8,000
Hotel			10,000
Multifamily			2,280
Total			20,280
D. Mitigation Rate			
Commercial	40%	<i>% of housing need</i>	3,200
Hotel	40%	<i>% of housing need</i>	4,000
Multifamily	60%	<i>% of housing need</i>	1,368
Total Housing to be Mitigated			8,568 sq. ft.
Fee	\$606	<i>per sq. ft. of housing need</i>	\$5,192,208
<i>Incentives to Encourage Construction</i>			
Units In Town	-30%	<i>of total to be mitigated</i>	5,998 sq. ft.
Units Out of Town	-15%		7,283 sq. ft.

SINGLE FAMILY

Description	Factor	Result
-------------	--------	--------

SINGLE FAMILY

A. New Development		<i>square feet</i>	5,000
B. Employees Generated	0.12	<i>per 1,000 sq. ft.</i>	0.6
C. Housing Need Generated	400	<i>sq. ft. per employee</i>	240
D. Mitigation Rate	60%	<i>% of housing need</i>	144
Total Housing to be Mitigated			144 sq. ft.
Fee	\$606	<i>per sq. ft. of housing need</i>	\$87,264

This fee represents approximately 2–2.5% of average single family home resale prices

Description	Mountain Village (proposed)	Peer Communities		
		Aspen	Jackson	Telluride
Commercial				
Development Size	1,000 sq. ft.	1,000 sq. ft.	1,000 sq. ft.	1,000 sq. ft.
Employee Generation Rate	2.00 /1,000 sq. ft.	4.50 /1,000 sq. ft.		4.00 /1,000 sq. ft.
Employees Generated	2.00	4.50		4.00
Housing Requirement	400 sq. ft./employee	400 sq. ft./employee		400 sq. ft./employee
Employee Housing Need Generated	800 sq. ft.	1,800 sq. ft.		1,600 sq. ft.
Mitigation Rate	40%	30%*		40%
Employee Housing to Mitigate	320 sq. ft.	540 sq. ft.	319 sq. ft.	640 sq. ft.
Fee in Lieu	\$606 per sq. ft. empl. housing	\$741 per sq. ft. empl. housing	\$301 per sq. ft. empl. housing	\$494 per sq. ft. empl. housing
Fee to be Paid	\$193,920	\$400,140	\$95,899	\$316,160
Hotel				
Development Size	50 rooms	50 rooms	50 rooms	50 rooms
Employee Generation Rate	0.50 /room	0.60 /room		0.33 /room
Employees Generated	25.00	30.00		17
Housing Requirement	400 sq. ft./employee	400 sq. ft./employee		400 sq. ft./employee
Employee Housing Need Generated	10,000 sq. ft.	12,000 sq. ft.		6,600 sq. ft.
Mitigation Rate	40%	65%		60%
Employee Housing to Mitigate	4,000 sq. ft.	7,800 sq. ft.	4,596 sq. ft.	3,960 sq. ft.
Fee in Lieu	\$606 per sq. ft. empl. housing	\$741 per sq. ft. empl. housing	\$301 per sq. ft. empl. housing	\$494 per sq. ft. empl. housing
Fee to be Paid	\$2,424,000	\$5,779,800	\$1,383,486	\$1,956,240
Residential (MF)				
Development Size	20 units	30,000 sq. ft.	30,000 sq. ft.	20 units
Employee Generation Rate	0.19 /unit	0.18 /1,000 sq. ft.		0.33 /unit
Employees Generated	3.80	5.40		6.60
Housing Requirement	400 sq. ft./employee	400 sq. ft./employee		400 sq. ft./employee
Employee Housing Need Generated	1,520 sq. ft.	2,160 sq. ft.		2,640 sq. ft.
Mitigation Rate	60%	65%		60%
Employee Housing to Mitigate	912 sq. ft.	1,404 sq. ft.	4,274 sq. ft.	1,584 sq. ft.
Fee in Lieu	\$606 per sq. ft. empl. housing	\$741 per sq. ft. empl. housing	\$301 per sq. ft. empl. housing	\$494 per sq. ft. empl. housing
Fee to be Paid	\$552,672	\$1,040,364	\$1,286,504	\$782,496
Residential (SF)				
Development Size	4,000 sq. ft.	4,000 sq. ft.	4,000 sq. ft.	4,000 sq. ft.
Employee Generation Rate	0.12 /1,000 sq. ft.	0.16 /1,000 sq. ft.**		0.23 /1,000 sq. ft.
Employees Generated	0.48	0.64		0.92
Housing Requirement	400 sq. ft./employee	400 sq. ft./employee		400 sq. ft./employee
Employee Housing Need Generated	192 sq. ft.	256 sq. ft.		368 sq. ft.
Mitigation Rate	60%	65%		60%
Employee Housing to Mitigate	115 sq. ft.	166 sq. ft.	103	221 sq. ft.
Fee in Lieu	\$606 per sq. ft. empl. housing	\$741 per sq. ft. empl. housing	\$301 per sq. ft. empl. housing	\$494 per sq. ft. empl. housing
Fee to be Paid	\$69,811	\$123,302	\$30,883	\$109,075

Peer community requirement
lower than Mountain Village

Peer community requirement
higher than Mountain Village

68

Note: Aspen and Jackson are both in process of updating these programs

QUESTIONS?

PROGRAM WALK-THROUGH

Mitigation Methods



AFFORDABLE HOUSING MITIGATION CALCULATOR

Development Type & Size

INSTRUCTIONS

1. Input project details and size for relevant development type(s) in green boxes
2. Resultant required housing mitigation/fee-in-lieu can be found in yellow boxes (total) and blue boxes (by mitigation type) (Note that blue boxes represent mitigation required if all requirement is mitigated using that method)
3. Enter amount of housing to be mitigated/fee to be paid by mitigation type in green boxes
4. Ensure total mitigation amount, accounting for all types, totals 100% of requirement

1. PROJECT & APPLICANT

Project Title	<input type="text"/>	Project Address	<input type="text"/>
Applicant Name	<input type="text"/>	Applicant Address	<input type="text"/>
Applicant Phone	<input type="text"/>	Applicant Email	<input type="text"/>
Date	<input type="text"/>		

Net floor area of **commercial** space proposed: sq. ft.
 Number of **hotel/accommodation** units proposed: units
 Number of free market **multifamily** residential units proposed: units
 Number of free market **single family** residential units proposed: sq. ft.

2. CALCULATION OF MINIMUM AFFORDABLE HOUSING REQUIREMENTS

For commercial/public facility uses:
 × 2.00 employees / 1,000 sq.ft. × 400 sq.ft./employee × 40% mitigation = sq. ft. employee housing
net space increase (sq. ft.)

For hotel and accommodation uses:
 × 0.50 employees / unit × 400 sq.ft./employee × 40% mitigation = sq. ft. employee housing
number of lodging units

For multi-family residential and mixed-use residential uses:
 × 0.18 employees / unit × 400 sq.ft./employee × 60% mitigation = sq. ft. employee housing
number of dwelling units

For single family residential uses:
 × 0.12 employees / 1,000 sq.ft. × 400 sq.ft./employee × 60% mitigation = sq. ft. employee housing
net space increase (sq. ft.)

TOTAL MINIMUM AFFORDABLE HOUSING REQUIREMENT = sq. ft. employee housing

Mitigation Calculation Accounts for:

- Employee generation
- Employee housing needs
- Mitigation rate

2. MITIGATION OPTIONS AND REQUIREMENTS

Units in Town

Commercial/public facility:	<input type="text"/> 0 sq. ft.	-30% discount	<input type="text"/> 0 sq. ft.
Hotel and accommodation:	<input type="text"/> 0 sq. ft.	-30% discount	<input type="text"/> 0 sq. ft.
Multi-family residential and mixed-use residential:	<input type="text"/> 0 sq. ft.	-30% discount	<input type="text"/> 0 sq. ft.
Single family residential:	<input type="text"/> 0 sq. ft.	-30% discount	<input type="text"/> 0 sq. ft.
TOTAL MINIMUM AFFORDABLE HOUSING REQUIREMENT	<input type="text"/> 0 sq. ft.	-30% discount	<input type="text"/> 0 sq. ft.

Units Out of Town

Commercial/public facility:	<input type="text"/> 0 sq. ft.	-15% discount	<input type="text"/> 0 sq. ft.
Hotel and accommodation:	<input type="text"/> 0 sq. ft.	-15% discount	<input type="text"/> 0 sq. ft.
Multi-family residential and mixed-use residential:	<input type="text"/> 0 sq. ft.	-15% discount	<input type="text"/> 0 sq. ft.
Single family residential:	<input type="text"/> 0 sq. ft.	-15% discount	<input type="text"/> 0 sq. ft.
TOTAL MINIMUM AFFORDABLE HOUSING REQUIREMENT	<input type="text"/> 0 sq. ft.	-15% discount	<input type="text"/> 0 sq. ft.

Fee in Lieu

For commercial/public facility uses:	<input type="text"/> 0 sq. ft.	0% discount	× \$606 /sq.ft.	<input type="text"/> \$0
For hotel and accommodation uses:	<input type="text"/> 0 sq. ft.	0% discount	× \$606 /sq.ft.	<input type="text"/> \$0
For multi-family residential and mixed-use residential uses:	<input type="text"/> 0 sq. ft.	0% discount	× \$606 /sq.ft.	<input type="text"/> \$0
For single family residential uses:	<input type="text"/> 0 sq. ft.	0% discount	× \$606 /sq.ft.	<input type="text"/> \$0
TOTAL MINIMUM AFFORDABLE HOUSING REQUIREMENT	<input type="text"/> 0 sq. ft.	0% discount	× \$606 /sq.ft.	<input type="text"/> \$0

Total Employee Housing Required

Net Required Mitigation

3. PROPOSED METHODS OF MEETING AFFORDABLE HOUSING MINIMUM REQUIREMENTS

Fill in all that apply:	<input type="text"/> 0	sq. ft.	% of Requirement
To be constructed within the Town of Mountain Village	<input type="text"/> 0	sq. ft.	0%
To be constructed within the Region	<input type="text"/> 0	sq. ft.	0%
Fees in Lieu to be paid	<input type="text"/> \$0		0%
4. Mitigation Requirement Met			0%

Mitigation Requirement



**AFFORDABLE HOUSING
MITIGATION CALCULATOR**

DRAFT

INSTRUCTIONS

1. Input project details and size for relevant development type(s) in green boxes
2. Resultant required housing mitigation/fee-in-lieu can be found in yellow boxes (total) and blue boxes (by mitigation type)
(Note that blue boxes represent mitigation required if all requirement is mitigated using that method)
3. Enter amount of housing to be mitigated/fee to be paid by mitigation type in green boxes
4. Ensure total mitigation amount, accounting for all types, totals 100% of requirement

1. PROJECT & APPLICANT

Project Title	<input type="text"/>	Project Address	<input type="text"/>
Applicant Name	<input type="text"/>	Applicant Address	<input type="text"/>
Applicant Phone	<input type="text"/>	Applicant Email	<input type="text"/>
Date	<input type="text"/>		

Net floor area of commercial space proposed:	<input type="text"/>	sq. ft.
Number of hotel/accommodation units proposed:	<input type="text"/>	units
Number of free market multifamily residential units proposed:	<input type="text"/>	units
Number of free market single family residential units proposed:	<input type="text"/>	sq. ft.

2. CALCULATION OF MINIMUM AFFORDABLE HOUSING REQUIREMENTS

For commercial/public facility uses:
 x 2.00 employees / 1,000 sq.ft. x 400 sq.ft./employee x 40% mitigation = sq. ft. employee housing
net space increase (sq. ft.)

For hotel and accommodation uses:
 x 0.50 employees / unit x 400 sq.ft./employee x 40% mitigation = sq. ft. employee housing
number of lodging units

For multi-family residential and mixed-use residential uses:
 x 0.19 employees / unit x 400 sq.ft./employee x 60% mitigation = sq. ft. employee housing
number of dwelling units

For single family residential uses:
 x 0.12 employees / 1,000 sq.ft. x 400 sq.ft./employee x 60% mitigation = sq. ft. employee housing
net space increase (sq. ft.)

TOTAL MINIMUM AFFORDABLE HOUSING REQUIREMENT = sq. ft. employee housing

DRAFT

DRAFT

2. MITIGATION OPTIONS AND REQUIREMENTS

	Total Employee Housing Required			Net Required Mitigation
Units in Town				
Commercial/public facility:	0 sq. ft.	-30% discount		0 sq. ft.
Hotel and accommodation:	0 sq. ft.	-30% discount		0 sq. ft.
Multi-family residential and mixed-use residential:	0 sq. ft.	-30% discount		0 sq. ft.
Single family residential:	0 sq. ft.	-30% discount		0 sq. ft.
TOTAL MINIMUM AFFORDABLE HOUSING REQUIREMENT	0 sq. ft.	-30% discount		0 sq. ft.
Units Out of Town				
Commercial/public facility:	0 sq. ft.	-15% discount		0 sq. ft.
Hotel and accommodation:	0 sq. ft.	-15% discount		0 sq. ft.
Multi-family residential and mixed-use residential:	0 sq. ft.	-15% discount		0 sq. ft.
Single family residential:	0 sq. ft.	-15% discount		0 sq. ft.
TOTAL MINIMUM AFFORDABLE HOUSING REQUIREMENT	0 sq. ft.	-15% discount		0 sq. ft.
Fee in Lieu				
For commercial/public facility uses:	0 sq. ft.	0% discount	x \$606 /sq.ft.	\$0
For hotel and accommodation uses:	0 sq. ft.	0% discount	x \$606 /sq.ft.	\$0
For multi-family residential and mixed-use residential uses:	0 sq. ft.	0% discount	x \$606 /sq.ft.	\$0
For single family residential uses:	0 sq. ft.	0% discount	x \$606 /sq.ft.	\$0
TOTAL MINIMUM AFFORDABLE HOUSING REQUIREMENT	0 sq. ft.	0% discount	x \$606 /sq.ft.	\$0

3. PROPOSED METHODS OF MEETING AFFORDABLE HOUSING MINIMUM REQUIREMENTS

Fill in all that apply:

To be constructed within the Town of Mountain Village
To be constructed within the Region
Fees in Lieu to be paid

		% of Requirement	Remainder to reach 100%
	sq. ft.	0%	0 sq. ft.
	sq. ft.	0%	0 sq. ft.
		0%	\$0
4. Mitigation Requirement Met		0%	

MEMORANDUM

To: Paul Wisor and Michelle Haynes, Town of Mountain Village

From: Andrew Knudtsen and Rachel Shindman, Economic & Planning Systems

Subject: Housing Mitigation Program Nexus Analysis;
EPS #213099

Date: March 10, 2022

The Economics of Land Use



This memo summarizes the nexus analysis completed by Economic & Planning Systems (EPS) and RRC Associates (RRC) for the creation of a housing linkage program in the Town of Mountain Village. The analysis establishes a nexus between new residential and commercial development and the demand for housing from new employees.

This work uses economic impact techniques to estimate the housing need generated from demand created by new development. This need can then be mitigated by providing units or paying a fee in lieu (linkage fee). The basis of the linkage fee is the gap between what the employees generated can afford to pay for housing and the cost to purchase the median priced condominium unit in Mountain Village.

The following sections outline the context and rationale for this program, and the methodology and results for calculating employee generation, housing need, and linkage fees for new residential and commercial development.

*Economic & Planning Systems, Inc.
730 17th Street, Suite 630
Denver, CO 80202-3511
303 623 3557 tel
303 623 9049 fax*

*Denver
Los Angeles
Oakland
Sacramento*

Context and Rationale

The Town of Mountain Village has recognized that the community housing inventory is not sufficient to meet demand and, as the community grows, the additional demand will place additional pressure on an already constrained inventory. As part of an effort to address this, the Town is looking to implement community housing mitigation requirements for new development, including commercial, lodging, multifamily, and single family uses, to be achieved through a linkage program.

The rationale for this program is as follows:

For **residential** development,

- New residential development brings in new residents with incomes that vary according to the price or rent of their home. These new households spend disposable income on things such as retail purchases, eating out, and repair and maintenance services.
- This spending generates new jobs in these industry and occupation categories (e.g., retail worker, landscaper, plumber). The number of employees generated determines the housing need created by new development, and the wages in each occupation category determine what these new employees can afford for housing.
- For some wage levels there will be a gap between what the employee can afford and the cost of housing affordable to that income range. The linkage fee is designed to mitigate this gap.

For **commercial** development,

- The jobs and wages generated are determined directly by the land use type, rather than from the indirect impacts of household spending.
- Commercial and hotel development have been evaluated to determine the number of jobs per square foot or per room, and the corresponding wage levels by the type of industry and occupation typical in these building types.
- Similar to the residential program, the number of employees generated determines the overall housing need, while the wages of these employees determines the affordability gap for these land uses.

The analysis uses development prototypes for residential and commercial development to determine employees generated, housing need, and affordability gap, following the methodologies outlined below.

Residential Methodology

The residential nexus analysis uses an economic impact model, Impact Analysis for Planning (IMPLAN), which estimates the relationships between new development and job generation. IMPLAN is widely used by state and federal agencies, academic researchers, and local economic development organizations to evaluate the economic impacts of proposed policies, new industries, and land use changes.

Analysis Steps

- **Household income** – The first step in the residential nexus analysis is calculating household income of households occupying new residential development. Household income is estimated from the value of the prototype (in this case, either a condominium or a single family home, detailed below), and the annual income needed to afford that home with 30 percent of household income devoted to housing costs (including mortgage payments, utilities, taxes, and other costs such as HOA dues).
- **Jobs generated by NAICS** – The household income associated with these new households is input to the IMPLAN model. IMPLAN applies an expenditure profile specific to different household income ranges and estimates the spending and jobs generated in the 20 major industries in the North American Industry Classification System (NAICS). IMPLAN accounts for savings in its expenditure patterns.
- **Jobs to employees (multiple job holder adjustment)** – An adjustment is made to acknowledge that many employees have more than one job, such as two part time jobs or a full time and a part time job. So as not to overestimate the number of *employees* generated, the number of jobs is reduced using a factor of 1.50 jobs per employee. This factor is specific to the region and comes from the 2018 *San Miguel County Housing Needs Assessment*.
- **Employees by NAICS to occupation and wages** – The IMPLAN model provides estimates of jobs by NAICS category but using the average wage by NAICS category would not yield enough detail on the spectrum of wages generated by each land use type to accurately portray income characteristics. The range of wages and occupations generated by new development is better represented by the 21 Standard Occupational Classifications defined by the Bureau of Labor Statistics (BLS). The National Industry by Occupation Matrix published by the BLS provides the estimated distribution of occupations for each NAICS category. The wages for each occupation in San Miguel County are estimated by indexing the national wages by occupation and industry to the average wage in that industry for San Miguel County, as the wage distribution is not available for sub-county areas.
- **Tabulation of employees by AMI Range** – The last step involves counting the number of employees generated in each income range (as a percent of Area Median Income). Given the high costs of housing in the Town of Mountain Village, this analysis includes all employees earning up to 200 percent of AMI.

Development Prototypes

Two market rate residential development prototypes were modeled for this analysis—single family detached housing and condominiums. Data inputs on unit size and price come from the San Miguel County MLS database and reflect sales of all homes in the Town of Mountain Village from 2018 through mid-2021 (the most recent data available at the onset of this study). Within the IMPLAN model, 100 units of each prototype were modeled in order to have enough significant figures for analysis and avoid small decimal figures in the results. This does not affect the housing need or fee calculation, as a per unit adjustment is made to calculate the final requirement.

- **Single Family Detached** – The single family detached prototype is modeled on a 4,850 square foot home with a value of \$3.765 million, as shown in **Table 1**. With 30 percent of income devoted to housing cost (including mortgage payments, insurance, HOA dues, and property taxes), this home would require a household income of \$788,000. For 100 units, the total household income is \$78.8 million; netting out payroll taxes (which are not accounted for in IMPLAN), \$47.4 million in new income is applied to the IMPLAN model.
- **Condominium** – Condominiums are modeled with an average unit size of 1,550 square feet and value of \$1.07 million. This requires an income of at least \$233,000 to afford. Utilizing the same approach as single family homes, total income modeled for 100 units is \$16.15 million.

Table 1. Residential Development Prototypes

Description	Factors	Condominium	
		(Multifamily)	Single Family
Program			
Units		100	100
Avg. Unit Sq. Ft.		1,486	4,850
Value			
Market Value		\$1,069,000	\$3,765,000
Target Purchase Price			
Mgt. Amt. (less downpayment)	10.0% down pmt	\$962,100	\$3,388,500
Mortgage Interest Rate	5.0% int.	5.0% int.	5.0% int.
Loan Term	30-year term	30-year term	30-year term
Monthly Costs			
Mortgage Payment (Monthly)		\$5,165	\$18,190
Insurance	\$2,500	\$208	\$208
Property Tax (mill levy, assess. ratio)	52.842 mills 7.15%	\$337	\$1,185
Miscellaneous (e.g. HOA Dues)	\$1,500	\$125	\$125
Total		\$5,835	\$19,709
HH Income per Unit	30%	\$233,387	\$788,358
Minus Payroll Tax			
Federal		\$49,876	\$253,161
FICA		\$8,854	\$8,854
Medicare		\$3,351	\$16,654
State		\$9,791	\$35,548
Total Deductions		\$71,871	\$314,216
Net Pay / Adjusted Household Income		\$161,516	\$474,142
Total Annual Household Income	100 households	\$23,338,676	\$78,835,781
Total Annual Payroll Tax	100 households	-\$7,187,120	-\$31,421,610
Total Adjusted Income		\$16,151,556	\$47,414,171

Source: MLS; Economic & Planning Systems

Job and Employee Generation

The household income generated from the new households, as noted above, is input to the IMPLAN model to estimate the jobs supported by new spending. **Table 2** summarizes the jobs generated by 100 units of each prototype. As shown, 100 condominium units generate 29.00 jobs, and 100 single family homes generate 85.13 jobs. The industries with the most jobs include real estate (including property management), accommodations and food services (restaurants and bars), retail, and health care. The pattern of job generation is consistent across each prototype. Because household incomes for both prototypes are above \$200,000 they have the same spending patterns given that the IMPLAN model does not distinguish spending patterns above this threshold. This means that job generation is directly proportional to income, so the single family development, which has a higher price and associated household income, generates a greater number of jobs than condominium development.

Table 2. Jobs by Industry Generated from Household Spending

Description	Jobs by Land Use (IMPLAN Results)	
	Condominium (Multifamily) <i>100 units</i>	Single Family <i>100 units</i>
	Household Income after Payroll Tax	\$16,151,556
Industrial Sectors		
11 Ag, Forestry, Fish & Hunting	0.14	0.41
21 Mining	0.02	0.05
22 Utilities	0.07	0.20
23 Construction	0.37	1.09
31-33 Manufacturing	0.07	0.21
42 Wholesale Trade	0.23	0.67
44-45 Retail trade	4.07	11.95
48-49 Transportation & Warehousing	0.42	1.22
51 Information	0.31	0.90
52 Finance & insurance	2.00	5.87
53 Real estate & rental	5.00	14.69
54 Professional- scientific & tech svcs	1.37	4.02
55 Management of companies	0.17	0.51
56 Administrative & waste services	1.20	3.52
61 Educational svcs	1.52	4.47
62 Health & social services	2.99	8.78
71 Arts- entertainment & recreation	1.63	4.78
72 Accommodation & food services	4.66	13.68
81 Other services	2.53	7.42
91-99 Government & non NAICs	<u>0.23</u>	<u>0.69</u>
Total	29.00	85.13

Source: IMPLAN; Economic & Planning Systems

Jobs to Employees – The next step is to adjust the number of jobs generated to the number of employees generated. In today’s economy it is common for people to hold more than one job. Without this adjustment, the analysis would potentially overestimate the housing demand created from jobs. To step down from jobs to employees, jobs are divided by a factor of 1.50 jobs per employee (the 2018 average for San Miguel County). As shown in **Table 3**, the 85.13 jobs generated by 100 units of the single family prototype results in 56.75 employees after the adjustment for multiple job holders, while the 29.00 jobs generated by 100 units of condominium development results in 19.33 employees.

Table 3. Employees by Industry Generated from Household Spending

Description	Employees by Land Use	
	Condominium (Multifamily)	Single Family
Jobs to Employee Conversion Factor	1.50	1.50
Industrial Sectors		
11 Ag, Forestry, Fish & Hunting	0.09	0.27
21 Mining	0.01	0.03
22 Utilities	0.05	0.13
23 Construction	0.25	0.73
31-33 Manufacturing	0.05	0.14
42 Wholesale Trade	0.15	0.45
44-45 Retail trade	2.71	7.97
48-49 Transportation & Warehousing	0.28	0.81
51 Information	0.21	0.60
52 Finance & insurance	1.33	3.91
53 Real estate & rental	3.33	9.79
54 Professional- scientific & tech svcs	0.91	2.68
55 Management of companies	0.11	0.34
56 Administrative & waste services	0.80	2.35
61 Educational svcs	1.01	2.98
62 Health & social services	1.99	5.85
71 Arts- entertainment & recreation	1.09	3.19
72 Accomodation & food services	3.11	9.12
81 Other services	1.69	4.95
91-99 Government & non NAICs	<u>0.15</u>	<u>0.46</u>
Total	19.33	56.75

Source: IMPLAN; Economic & Planning Systems

Employees by Occupation – The jobs by NAICS classification are converted to specific occupation categories to obtain a more detailed distribution of wage levels for the new jobs, since using the average wage for an industry masks the upper and lower wage levels. As noted previously, the BLS National Industry by Occupation Matrix provides the estimated distribution of occupations for each NAICS category. The wages for each occupation in San Miguel County are estimated by indexing the wages by occupation and industry nationally to the average wage in that industry for San Miguel County. For jobs generated by residential development, top occupations are: food preparation and serving, sales, and office and administrative support.

These new employees represent the housing need generated by new residential development. Based on this need and assuming 400 square feet of housing per employee, 100 units of single family housing (totaling 485,000 square feet of new construction) generates a total need of 22,700 square feet of employee housing (or 46.8 square feet of employee housing per 1,000 square feet of new home construction). A hundred (100) units of new condominium development generates a need of 7,732 square feet of employee housing, or 77.32 square feet per new condominium unit.

Residential Linkage Fee Calculation

To calculate a mitigation fee (in lieu of providing the housing required), the affordability gap of these new employees need to be calculated.

To do this, the employees at income levels of 200 percent of AMI or less are tabulated. For 100 units of single family development, there are 56.73 employees generated below 200 percent of AMI, and for 100 condominium units there are 19.33 employees generated below this threshold, as shown in **Table 4**.

Table 4. Employees by AMI Generated by New Household Spending

	Condominium (Multifamily)	Single Family
Total Employees Generated per 100 Units	19.33	56.75
Employees by Income Range		
30% of Median	0.00	0.00
50% of Median	3.47	10.18
80% of Median	10.95	32.14
100% of Median	2.04	6.00
120% of Median	0.71	2.10
150% of Median	1.49	4.39
200% of Median	<u>0.65</u>	<u>1.92</u>
Total - Target Income Ranges	19.33	56.73

Source: Economic & Planning Systems

To determine affordability needs, the gap across the wage spectrum is calculated based on the cost to purchase a home in the Town, estimated using the median cost for all condominiums from 2018 through mid-2021.

As shown in **Table 5**, prices affordable to employees at these AMI levels range from \$16,600 at 30 percent of AMI to \$465,100 at 200 percent AMI. With a median home cost of \$1.069 million, the gap per unit ranges from \$1.052 million at 30 percent AMI to \$603,900 at 200 percent AMI. On a per square foot basis, with a median condominium size of 1,486 square feet, the affordability gap ranges from \$406 to \$708 per square foot.

To determine an appropriate fee to mitigate this need, the weighted average gap per square foot is calculated by multiplying the number of employees generated in each AMI category by the gap per square foot per employee. This results in the total affordability gap generated by each prototype, which, divided by the number of employees generated, results in the weighted average fee per square foot (based on affordability needs).

Table 5. Affordable Price and Gap by Income Range

Description	Factor	AMI						
		30%	50%	80%	100%	120%	150%	200%
HH Income and Housing Expense								
HH Income (1.0-person household)		\$17,130	\$28,550	\$45,680	\$57,100	\$68,520	\$85,650	\$114,200
Affordable Monthly Housing Cost	30%	\$428	\$714	\$1,142	\$1,428	\$1,713	\$2,141	\$2,855
Supportable Monthly Payment								
Less: Insurance	\$2,500/year	-\$208	-\$208	-\$208	-\$208	-\$208	-\$208	-\$208
Less: Property Taxes	7.15% ass't rate 52.842 mills	-\$10	-\$30	-\$50	-\$70	-\$80	-\$110	-\$150
Less: Miscellaneous (e.g. HOA Dues)	\$1,500/year	-\$125	-\$125	-\$125	-\$125	-\$125	-\$125	-\$125
Net Supportable Mortgage Payment (Monthly)		\$85	\$350	\$759	\$1,024	\$1,300	\$1,698	\$2,372
Valuation Assumptions								
Loan Amount		\$15,800	\$65,300	\$141,300	\$190,800	\$242,100	\$316,300	\$441,800
Mortgage Interest Rate		5.0% int.	5.0% int.	5.0% int.	5.0% int.	5.0% int.	5.0% int.	5.0% int.
Loan Term		30-year term	30-year term	30-year term	30-year term	30-year term	30-year term	30-year term
Downpayment as % of Purchase Price		5.0% down pmt	5.0% down pmt	5.0% down pmt	5.0% down pmt	5.0% down pmt	5.0% down pmt	5.0% down pmt
Maximum Supportable Purchase Price		\$16,600	\$68,700	\$148,700	\$200,800	\$254,800	\$332,900	\$465,100
Cost per Unit		\$1,069,000	\$1,069,000	\$1,069,000	\$1,069,000	\$1,069,000	\$1,069,000	\$1,069,000
Gap per Unit		\$1,052,400	\$1,000,300	\$920,300	\$868,200	\$814,200	\$736,100	\$603,900
Square feet per unit		1,486	1,486	1,486	1,486	1,486	1,486	1,486
Gap per square foot		\$708	\$673	\$619	\$584	\$548	\$495	\$406

Source: Economic & Planning Systems

Based on this calculation, the gap for both single family and multifamily development is \$606 for each square foot of employee housing need generated by new market rate housing, as shown in **Table 6**.

Table 6. Residential Fee Calculation

		Condominium (Multifamily)	Single Family
Employees Generated (per 100 units)	A		
30% of Median		0.0	0.0
50% of Median		3.5	10.2
80% of Median		10.9	32.1
100% of Median		2.0	6.0
120% of Median		0.7	2.1
150% of Median		1.5	4.4
200% of Median		<u>0.7</u>	<u>1.9</u>
Total per 100 Units		19.3	56.7
Per 1.0 Units		0.19	0.57
Gap per Square Foot per Employee by AMI Range	B		
30% of Median		\$708	\$708
50% of Median		\$673	\$673
80% of Median		\$619	\$619
100% of Median		\$584	\$584
120% of Median		\$548	\$548
150% of Median		\$495	\$495
200% of Median		\$406	\$406
Total Gap			
30% of Median	A X B	\$0	\$0
50% of Median		\$2,338	\$6,855
80% of Median		\$6,780	\$19,907
100% of Median		\$1,194	\$3,505
120% of Median		\$391	\$1,150
150% of Median		\$740	\$2,174
200% of Median		<u>\$265</u>	<u>\$779</u>
Total	C	\$11,709	\$34,370
Employees Generated	D	19	57
Gap (Max. Fee) per Employee	C / D	\$606	\$606

Source: Economic & Planning Systems

Commercial Methodology

The commercial linkage analysis is based on estimates of direct jobs generated by new development, rather than the jobs generated by household spending. This analysis was done for two categories of development – hotel and general commercial (e.g., retail, government, office) – to account for the differing patterns of job generation between hotel/accommodation and other commercial uses.

Job Generation Calculation

Total Jobs – The first step in the commercial nexus analysis is determining the total number of jobs in Mountain Village, by space type (hotel or general commercial). For this analysis, businesses located in residential spaces (i.e., home-based businesses) were excluded. This data is drawn from QCEW employer address files for San Miguel County, covering the period of January 2019 through June 2021. Average annual employment for the Town of Mountain Village for the 2019 calendar year was ultimately used in the employment generation calculations, as being more representative of employment conditions than Covid-impacted 2020 and 2021.

Total Commercial Square Footage and Hotel Rooms – The second step is to determine the total commercial square footage in the town, by type of business occupying the space (hotel or general commercial). For hotels, space is calculated based on number of lodging rooms, rather than square footage. The source of the commercial square footage data was a commercial building space database created by EPS in support of the Mountain Village Comprehensive Plan. EPS identified commercial square footage in Mountain Village by building and tenant as part of that planning effort. Various types of space were included in the non-hotel category, including retail, restaurant, office, quasi-industrial, etc.

Job Generation Rate – To calculate the employment generation rate for general commercial space, the aggregate employment in Mountain Village is divided by the aggregate commercial square footage; for hotels, the aggregate hotel employment is divided by aggregate lodging rooms. This results in a generation rate of employees per 1,000 square feet of general commercial space or employees per hotel room. For the Town of Mountain Village, job generation rates are 3.0 employees per 1,000 square feet of general commercial space, and 0.75 employees per hotel room.

Analysis Notes

- **Geographic identification** – GIS address matching, along with manual checks, was used to geo-locate San Miguel County QCEW employers that were based in nonresidential properties within Mountain Village.
- **TSG** – The Telluride Ski and Golf Company is a large employer with multiple different operations in Mountain Village. Since the employment focus of this analysis is employment associated with the occupancy of building space, the analysis excluded TSG mountain operations employment (and modest square footage) from the analysis. However, TSG-owned hotel and restaurant operations (and the corresponding square footage) were included in the calculations.

- Hotel-Located Commercial** – Employment in hotel-run restaurants, retail outlets and conference spaces was assigned to the hotel employment generation category. This is because hotel employment was typically reported for the hotel as a whole, not broken out by function within the hotel. However, restaurant/retail/office establishments located in but NOT operated by the hotels (e.g., separate businesses that lease space in hotels and show up as separate QCEW employers) were assigned to non-hotel employment. The implications are, at time of building permit, for the Town of Mountain Village staff to delineate the range of uses considered part of the hotel operations from those that operate externally from the hotel and apply the appropriate mitigation factors accordingly.

Employee Generation and Housing Need

For analysis purposes, commercial impacts are calculated for 5,000 square feet of general commercial space and 50 rooms of hotel space. From these aggregate figures, the analysis provides specific ‘per square foot’ and ‘per room’ factors that can be applied to future development proposals. As shown in **Table 7**, and based on the analysis outlined above, general commercial space generates 3.0 jobs per 1,000 square feet of space (15.0 jobs for the 5,000 square foot prototype), and hotel space generates 0.75 jobs per room (37.5 jobs for the 50 room prototype).

Table 7. Commercial Development Prototypes

Description	Building Sq. Ft.	Job Generation	Jobs
General Commercial Hotel	5,000 sq. ft.	333 sqft/empl	15.0
	50 rooms	0.75 emp/room	37.5

Source: RRC; Economic & Planning Systems

With total job generation determined, the next step is to assign each land use to a mix of industries to estimate the wage characteristics of the employees generated. While hotels fall solely in the accommodations and food services sector, general commercial falls more broadly across multiple industries including retail, accommodations, real estate, and government, as shown in **Table 8**.

Table 8. Land Use to Industry Category Conversion

Description	Land Use to NAICS Conversion	
	General Commercial	Hotel
Industrial Sectors		
11 Ag, Forestry, Fish & Hunting	0%	0%
21 Mining	0%	0%
22 Utilities	0%	0%
23 Construction	0%	0%
31-33 Manufacturing	0%	0%
42 Wholesale Trade	0%	0%
44-45 Retail trade	18%	0%
48-49 Transportation & Warehousing	0%	0%
51 Information	1%	0%
52 Finance & insurance	2%	0%
53 Real estate & rental	10%	0%
54 Professional- scientific & tech svcs	7%	0%
55 Management of companies	1%	0%
56 Administrative & waste services	0%	0%
61 Educational svcs	0%	0%
62 Health & social services	0%	0%
71 Arts- entertainment & recreation	0%	0%
72 Accommodation & food services	46%	100%
81 Other services	0%	0%
91-99 Government & non NAICs	<u>16%</u>	<u>0%</u>
Total	100%	100%

Source: RRC Associates; LEHD; Economic & Planning Systems

Similar to residential job generation, the jobs generated by commercial development are reduced to account for multiple job holders. In Mountain Village, evaluation of the local economic conditions indicates a figure of 1.5 jobs per employee, reducing the 15 general commercial jobs to 10 employees (an *employee* generation rate of 2.0 per 1,000 square feet) and the 37.50 hotel jobs to 25 employees (an *employee* generation rate of 0.5 per room), as shown in **Table 9**.

Table 9. Jobs and Employees Generated by New Commercial Development

Description	Jobs by Land Use		Employees by Land Use	
	General Commercial	Hotel	General Commercial	Hotel
Industrial Sectors				
11 Ag, Forestry, Fish & Hunting	0.00	0.00	0.00	0.00
21 Mining	0.00	0.00	0.00	0.00
22 Utilities	0.00	0.00	0.00	0.00
23 Construction	0.00	0.00	0.00	0.00
31-33 Manufacturing	0.00	0.00	0.00	0.00
42 Wholesale Trade	0.00	0.00	0.00	0.00
44-45 Retail trade	2.66	0.00	1.77	0.00
48-49 Transportation & Warehousing	0.00	0.00	0.00	0.00
51 Information	0.19	0.00	0.13	0.00
52 Finance & insurance	0.33	0.00	0.22	0.00
53 Real estate & rental	1.50	0.00	1.00	0.00
54 Professional- scientific & tech svcs	0.98	0.00	0.66	0.00
55 Management of companies	0.08	0.00	0.05	0.00
56 Administrative & waste services	0.00	0.00	0.00	0.00
61 Educational svcs	0.00	0.00	0.00	0.00
62 Health & social services	0.00	0.00	0.00	0.00
71 Arts- entertainment & recreation	0.00	0.00	0.00	0.00
72 Accomodation & food services	6.87	37.50	4.58	25.00
81 Other services	0.00	0.00	0.00	0.00
91-99 Government & non NAICs	<u>2.40</u>	<u>0.00</u>	<u>1.60</u>	<u>0.00</u>
Total	15.00	37.50	10.00	25.00

Source: RRC Associates; LEHD; Economic & Planning Systems

These new employees represent the housing need generated by new commercial development. Assuming 400 square feet of housing per employee, 5,000 square feet of general commercial development generates a total need of 4,000 square feet of employee housing (or 800 square feet of employee housing per 1,000 square feet of new construction). A 50-room hotel generates a need of 10,000 square feet of employee housing, or 200 square feet per new hotel room.

Commercial Linkage Fee Calculation

To estimate the income of these employees, the same process is used for commercial development as residential development. The distribution of occupations within each industry is determined from the National Industry-Occupation Matrix, and the wages for each occupation are applied to the new employees.

The number of employees by occupation and wage category are then tabulated by AMI level at or below 200 percent of AMI. As shown in **Table 10**, 5,000 square feet of general commercial development generates 10 employees at 200 percent AMI or less, while 50 new hotel rooms generate 25 employees earning 200 percent AMI or below.

Table 10. Employees Generated in Target Income Ranges

	General Commercial	Hotel
Total Employees Generated	10.0	25.0
Employees by Income Range		
30% of Median	0.0	0.0
50% of Median	0.4	0.0
80% of Median	7.2	22.4
100% of Median	1.1	1.5
120% of Median	0.6	0.3
150% of Median	0.4	0.2
200% of Median	<u>0.3</u>	<u>0.7</u>
Total - Target Income Ranges	10.0	25.0

Source: Economic & Planning Systems

The affordability gap analysis for these employees follows the same methodology as residential linkage. As shown previously, the per-unit affordability gap per employee and AMI level ranges from \$603,900 at 200 percent of AMI to \$1.052 million at 30 percent of AMI, a per square foot gap of between \$406 and \$708.

To calculate the fee-in-lieu for commercial development, the weighted average affordability gap is determined by multiplying the number of employees generated in each AMI category by the gap per square foot, then dividing by the employment generated. As shown in **Table 11**, this results in a gap for general commercial development of \$603 per square foot of employee housing need generated. For hotel development, the gap is \$610 per square foot of employee housing need generated.

Based on these fee calculations and the \$606 per square foot residential fee, an overall fee (for all development types) of \$606 per square foot is recommended.

Table 11. Commercial Linkage Fee Calculation

		General Commercial	Hotel (50 Rooms)
Square Feet or Rooms		5,000	50
Employees by Income Range	A		
30% of Median		0.00	0.00
50% of Median		0.45	0.00
80% of Median		7.21	22.41
100% of Median		1.11	1.48
120% of Median		0.57	0.25
150% of Median		0.37	0.17
200% of Median		<u>0.29</u>	<u>0.69</u>
Total per 5,000sf / 50 Rooms		10.00	25.00
Gap per Square Foot per Employee by AMI Range	B		
30% of Median		\$708	\$708
50% of Median		\$673	\$673
80% of Median		\$619	\$619
100% of Median		\$584	\$584
120% of Median		\$548	\$548
150% of Median		\$495	\$495
200% of Median		\$406	\$406
Total Gap	A X B		
30% of Median		\$0	\$0
50% of Median		\$303	\$0
80% of Median		\$4,464	\$13,877
100% of Median		\$650	\$863
120% of Median		\$311	\$139
150% of Median		\$184	\$85
200% of Median		\$117	\$280
Total	C	\$6,029	\$15,244
Employees Generated		10	25
Gap (Max. Fee) per Employee Generated		-\$603	-\$610

Source: Economic & Planning Systems

Linkage Program Summary

Based on this analysis and Town standards for employee housing, the following program components are recommended:

	Employee Generation	Housing Requirement	Fee in Lieu
<i>Residential – Multifamily</i>	0.19 employees per unit	400 sq. ft. per employee	\$606 per sq. ft. of employee housing
<i>Residential – Single Family</i>	0.12 employees per 1,000 sq. ft.	400 sq. ft. per employee	\$606 per sq. ft. of employee housing
<i>Commercial – General Commercial</i>	2.0 employees per 1,000 sq. ft.	400 sq. ft. per employee	\$606 per sq. ft. of employee housing
<i>Commercial – Hotel/Accommodation</i>	0.50 employees per room	400 sq. ft. per employee	\$606 per sq. ft. of employee housing

Application of Findings

This nexus study provides a basis for the Town to move forward with new standards within the Town’s Land Use Regulations. For a clearer understanding of the ways these will be incorporated into the code, as well as how they will be summarized with a user-friendly worksheet for developers to complete, please see the accompanying material provided by staff.

Glenwood Springs Office
901 Grand Avenue, Suite 201
Glenwood Springs, Colorado 81601
Telephone (970) 947-1936
Facsimile (970) 947-1937

GARFIELD & HECHT, P.C.
ATTORNEYS AT LAW
Since 1975

www.garfieldhecht.com

MEMORANDUM

TO: Town of Mountain Village
FROM: David McConaughy
Christine Gazda
RE: Housing Impact Mitigation Ordinance – Version 2
DATE: April 12, 2022

This memorandum is intended to explain changes to the second version of the Ordinance Amending Chapters 16.01, 16.02, 17.3, and 17.9 of the Community Development Code Concerning Affordable Housing Restrictions and Adopting Housing Impact Mitigation Requirements.

This second version includes the following changes:

- “Affordable” and “employee” housing changed to “workforce” housing;
- Eliminated substantive changes to Chapters 16.01 and 16.02, saving for future ordinance;
- Allows Town Council to adjust initial sales price and appreciation cap by annual resolution;
- Staff’s recommendation that “outside the Town limits” be defined as “within the boundaries of the San Miguel Authority for Regional Transportation service areas”;
- Allows Town Council to amend Mitigation Worksheet, by resolution, from time to time but no more than annually; and
- Deed restriction requirement changed to broader “agreement restricting use,” etc.

Other considerations include:

1. Should the definition of “commercial development” in Section 17.3.9(C) exclude “municipal facilities” as defined in Section 17.8.1? As written, the ordinance would exempt Town-owned facilities but not necessarily facilities owned by other local governments such as the Fire District, School District, Post Office, etc. Keep in mind that some local governments, such as the school district, may claim to be exempt from local land use regulations regardless.
2. What developments should be exempt from these requirements? *See* proposed new subsection 17.3.9(E).
 - Should all “municipal facilities” be exempt? For example, the Fire District constructing a new fire station within the Town would generate new employees.
 - Should non-profit and volunteer-based organization be exempt? Arguably, nobody is going to move to Mountain Village to take a volunteer position – such positions would more likely be recruited from existing residents. Should non-profits be required to demonstrate some local community benefit to qualify for an exemption? For example, should a charitable organization working on alleviating world hunger be treated the same as a local church or a non-profit dance studio for local children?
3. What should be the process for request for an exemption or reduced requirements? *See* proposed new subsection 17.3.9(E). Should requests for exemptions or reductions be determined by Town Staff with an appeal right to Council, or should all such requests require Council action?

From: [Scott Pearson](#)
To: [Michelle Haynes](#)
Subject: Public comment on housing mitigation
Date: Monday, April 4, 2022 6:08:35 AM

April 4, 2022

To the Town Council,

I write to submit public comment on the proposed housing impact mitigation requirements for Mountain Village.

I am concerned that the proposed requirements are severely inadequate to address the housing impact of proposed development.

1. Hotels can generate far more than 0.5 FTEs per room. A common rule of thumb for luxury hotels, for example, is 2 FTE per room.
2. The 400 square feet per employee does not take into account the fact that many employees have families.
3. The 400 square foot per employee also does not consider the multiplier effect of a new employee. That person needs municipal and medical services, their children go to school, and the family shops for groceries and engages in other economic and social activity that itself requires new workers.
4. The mitigation factor of just 40% and the incentives to build locally - such as the 30% reduction for building in town - further reduces the new housing that will be built.

To provide an example, suppose the proposed luxury hotel by the gondola has 100 rooms. They will probably employ 200 people. If 40% of those employees have families of 2 additional people, that implies housing needs for 360. Even a modest estimate of an economic multiplier would add 40 additional teachers, police, healthcare workers, retail workers etc. to serve that added 360. So new housing will be needed for 400 individuals.

According to the ordinance, if housing were built in town, the new hotel would need to provide housing for just 14 people. (100 rooms time 0.5 workers per room times the 40% mitigation factor less the 30% incentive for building in town). This mitigation is just 3.5% if the actual housing impact of this hotel.

I urge the Council to consider the actual housing impact of developments and ensure that our mitigation requirements are sufficient to address this. Otherwise the critical housing issues we are facing now will only worsen.

Respectfully,
Scott Pearson
225 Touchdown Drive
Mountain Village

SDPearson@aol.com
202-495-8722



Agenda Item No. 7
PLANNING & DEVELOPMENT SERVICE
PLANNING DIVISION
455 Mountain Village Blvd.
Mountain Village, CO 81435
(970) 728-1392

TO: Mountain Village Town Council
FROM: Michelle Haynes, Planning and Development Services Director
FOR: Town Council Meeting of April 21, 2022
DATE: April 8, 2022
RE: Second Reading and Council Vote on an Ordinance Regarding Amendments the Community Development Code Section 17.2.3 Design Review Board to Remove the Term Limit Provision, Change the Term from Two Years to Four Years, Amend the Meeting Date from the 4th Thursday to the 1st Thursday and Address Lot Owner and Residency Requirements as it Related to Board Composition

HISTORY

The Town attorney in concert with the Town Council discussed and directed a few edits to the Design Review Board powers and duties found in the CDC at Section 17.2.3. We are also taking this opportunity to clarify and amend sections as a matter of clarity.

SUMMARY OF PROPOSED CHANGES

CDC edits include the following:

1. Striking term limits for the DRB board members.
2. A ministerial amendment to change the DRB meeting date from the 4th Thursday to the 1st Thursday.
3. Change the residency requirement from "strive to appoint at least three members of the DRB who lot owners or residents of the Mountain Village", to "require at least three members to be lot owners or residents, and strive to appoint at least five members to be lot owners or residents of the Mountain Village".
4. Change terms from 2 years to 4 years. This will reduce administrative time it takes to advertise on every alternating year for 4 seats then 5 seats, which has the perception that we are always advertising for seats on the DRB.

DRB RECOMMENDATION

The DRB provided a unanimous recommendation at the March 17, 2021 Joint Special meeting.

ATTACHMENTS

- Ordinance

PROPOSED MOTION TOWN COUNCIL

I move to approve, on second reading of an ordinance, amendments to CDC Section 17.2.3, attached as exhibit A, DRB powers and duties.

/mbh

ORDINANCE NO. 2022-__

**AN ORDINANCE OF THE TOWN COUNCIL OF THE TOWN OF MOUNTAIN VILLAGE,
COLORADO AMENDING SECTION 17.2.3 OF THE COMMUNITY DEVELOPMENT CODE
CONCERNING DESIGN REVIEW BOARD MEMBERSHIP REQUIREMENTS AND TERM LIMITS**

WHEREAS, the Town of Mountain Village (“Town”) is a home rule municipality duly organized and existing under Article XX of the Colorado Constitution and the Town of Mountain Village Home Rule Charter of 1995, as amended (the “Charter”); and

WHEREAS, Title 17 of the Town of Mountain Village Municipal Code (“Code”) is known as the Town of Mountain Village Community Development Code (“CDC”), and Chapter 17.2 of the CDC outlines the requirements and limitations for membership on the Town’s Design Review Board (“Board”); and

WHEREAS, the Town and its residents benefit from having a certain number of Board members be lot owners or residents of the Town;

WHEREAS, the Town Council has considered the pros and cons of term limits on Board membership and has concluded that the benefits of having the option to utilize the experience and institutional knowledge of long-term Board members outweighs the benefits of term limits, provided that re-appointment of any Board member remains in the discretion of the Town Council regardless of the time served; and

WHEREAS, in compliance with Section 17.1.7 of the Code, the Board reviewed the proposed amendment and provided a recommendation to Town Council on _____, 2022; and

WHEREAS, based on the Board’s recommendation and public comments, the Town Council desires to amend the CDC to change the membership requirements and term limits of the Design Review Board as set forth below.

NOW, THEREFORE, BE IT ORDAINED BY THE TOWN COUNCIL OF THE TOWN OF MOUNTAIN VILLAGE, COLORADO, as follows:

Section 1. Recitals. The above recitals are hereby incorporated as findings of the Town Council in support of the enactment of this Ordinance.

Section 2. Amendment to the CDC. Section 17.2.3 of the CDC is hereby amended to read as set forth in Exhibit A, attached hereto.

Section 3. Severability. If any portion of this Ordinance is found to be void or ineffective, it shall be deemed severed from this Ordinance and the remaining provisions shall remain valid and in full force and effect.

Section 4. Safety Clause. The Town Council hereby finds, determines, and declares that this Ordinance is promulgated under the general police power of the Town, that it is promulgated for the health, safety, and welfare of the public, and that this Ordinance is necessary for the preservation of health and safety and for the protection of public convenience and welfare. The Town Council further determines that the Ordinance bears a rational relation to the proper legislative object sought to be obtained.

Section 5. Effective Date. This Ordinance shall become effective on _____, 2022 and shall be recorded in the official records of the Town kept for that purpose and shall be authenticated by the signatures of the Mayor and the Town Clerk.

Section 6. Public Hearing. A public hearing on this Ordinance was held on the ___ day of _____, 2022 in the Town Council Chambers, Town Hall, 455 Mountain Village Blvd., Mountain Village, Colorado 81435.

Section 6. Publication. The Town Clerk or Deputy Town Clerk shall post and publish notice of this Ordinance as required by Article V, Section 5.8 of the Charter.

INTRODUCED, READ AND REFERRED to public hearing before the Town Council of the Town of Mountain Village, Colorado on the ___ day of _____, 2022

TOWN OF MOUNTAIN VILLAGE:

**TOWN OF MOUNTAIN VILLAGE, COLORADO,
A HOME-RULE MUNICIPALITY**

By: _____
Laila Benitez, Mayor

ATTEST:

Susan Johnston, Town Clerk

HEARD AND FINALLY ADOPTED by the Town Council of the Town of Mountain Village, Colorado this ___ day of _____, 2022

TOWN OF MOUNTAIN VILLAGE:

**TOWN OF MOUNTAIN VILLAGE, COLORADO,
A HOME-RULE MUNICIPALITY**

By: _____
Laila Benitez, Mayor

ATTEST:

Susan Johnston, Town Clerk

Approved as to Form:

David McConaughy, Town Attorney

I, Susan Johnston, the duly qualified and acting Town Clerk of the Town of Mountain Village, Colorado ("Town") do hereby certify that:

1. The attached copy of Ordinance No. 2022-__ ("Ordinance") is a true, correct, and complete copy thereof.
2. The Ordinance was introduced, read by title, approved on first reading and referred to public hearing by the Town Council the Town ("Council") at a regular meeting held at Town Hall, 455 Mountain Village Blvd., Mountain Village, Colorado, on _____, 2022, by the affirmative vote of a quorum of the Town Council as follows:

Council Member Name	"Yes"	"No"	Absent	Abstain
Laila Benitez, Mayor				
Dan Caton, Mayor Pro-Tem				
Marti Prohaska				
Harvey Mogenson				
Patrick Berry				
Peter Duprey				
Jack Gilbride				

3. After the Council's approval of the first reading of the Ordinance, notice of the public hearing, containing the date, time and location of the public hearing and a description of the subject matter of the proposed Ordinance was posted and published in the Telluride Daily Planet, a newspaper of general circulation in the Town, on _____, 2022 in accordance with Section 5.2(d) of the Town of Mountain Village Home Rule Charter.
4. A public hearing on the Ordinance was held by the Town Council at a regular meeting of the Town Council held at Town Hall, 455 Mountain Village Blvd., Mountain Village, Colorado, on _____, 2022. At the public hearing, the Ordinance was considered, read by title, and approved without amendment by the Town Council, by the affirmative vote of a quorum of the Town Council as follows:

Council Member Name	"Yes"	"No"	Absent	Abstain
Laila Benitez, Mayor				
Dan Caton, Mayor Pro-Tem				
Marti Prohaska				
Harvey Mogenson				
Patrick Berry				
Peter Duprey				
Jack Gilbride				

5. The Ordinance has been signed by the Mayor, sealed with the Town seal, attested by me as Town Clerk, and duly numbered and recorded in the official records of the Town.

IN WITNESS WHEREOF, I have hereunto set my hand and affixed the seal of the Town this ___ day of _____, 2022.

 Susan Johnston, Town Clerk
 (SEAL)

Exhibit A

17.2.3 Design Review Board.

B. Seven (7) regular members to the DRB shall be appointed by the Town Council. ~~The maximum number of years that a member may serve shall be twelve (12) consecutive years, subject to reappointment by the Council pursuant to section D below.~~ In accordance with the provisions of the Town Charter, three (3) members are to be appointed in odd numbered years, and four (4) members are to be appointed in even numbered years. Up to two (2) alternate members may be appointed by the Town Council for ~~two (2)~~ four (4) year terms. Alternate members shall only vote when one of the seven (7) regular members cannot vote due to a prohibition in the Town's Code of Ethics or when a regular member is absent from a meeting. Any appointed alternate members shall actively participate in the discussion of agenda items, site visits and other DRB activities.

C. The Council shall ~~strive to~~ appoint at least three (3), and strive to appoint at least five (5), or more members of the DRB who are lot owners or residents of Mountain Village; ~~however, residency is not a requirement for appointment but is preferred.~~ The term for a DRB member shall be for ~~two (2)~~ four (4) years.

H. Regular meetings of the DRB shall be held on the ~~fourth~~ first (1st) Thursday of each month unless there is a conflict in such meeting date, in which case, a new DRB meeting date will be established in the annual DRB meeting calendar. The DRB may conduct special meetings, in addition to regularly scheduled meetings, as circumstances may require and as determined by the Director of Community Development. The agenda of all DRB meetings and site visits shall be noticed by:



AGENDA ITEM #8
TOWN MANAGER
455 Mountain Village Blvd.
Mountain Village, CO 81435
(970) 729-2654

TO: Mountain Village Town Council
FROM: Paul Wisor, Town Manager
DATE: April 13, 2022
RE: Timing of Adoption of Comprehensive Plan Amendments

Executive Summary: The Town has been engaged in proposed amendments to the 2011 Comprehensive Plan since October 2020. Staff considered the latest draft of the amendments at its March 17th meeting. In light of the direction provided by Town Council at that meeting, Town Council should discuss a timeline for adoption of the proposed amendments to the 2011 Comprehensive Plan.

Overview

In October of 2020, the Town issued an RFP for the purpose of engaging a consulting firm to assist the Town in amending its Comprehensive Plan, which was originally adopted in 2011. The Comprehensive Plan was originally adopted to encourage future development while controlling growth.

The Town, along with its consultants MIG and EPS, issued a draft of proposed changes to the Comprehensive Plan in October 2021, and the Mountain Village community thereafter provided a significant amount of substantive comments with respect to those amendments.

On December 9, 2021, Council discussed the areas of most concern to the public and Council, chief among them hotbeds, deed restricted housing, the Meadows Subarea, and open space. Council provided direction to staff and its consultants, including the formation of a Meadows Resident Advisory Board to provide additional input on specific topics pertinent to Meadows residents.

Council continued its discussion on January 20 to discuss further changes to hot beds, deed restricted housing, and public benefits.

As a result of the December 9 and January 20 Council discussions, the Town published a Draft Comprehensive Plan Amendment, dated January 26, 2022. The Town received over 80 public comments between January 18th and March 10th with respect to the latest drafts, and Town Council reviewed and discussed the latest draft on March 17th.

Proposed Timing

It is anticipated the Meadows Resident Advisory Committee will provide recommendations to Council on the Meadows Subarea in June 2022. In addition, Town Council is in the process of adopting a housing mitigation methodology, which Town Council has requested be made part of

the Comprehensive Plan Amendments. It is anticipated the Town Council will hold a second reading on the mitigation ordinance in May 2022.

Given the timing of Meadows Subarea amendments as well as the mitigation amendments, Council should consider a resolution adopting the Comprehensive Plan Amendments no sooner than June 2022. Council should consider whether June 2022 is an appropriate timeline for adoption, or if more time is needed to further discuss the proposed amendments.



AGENDA ITEM #9
TOWN MANAGER
455 Mountain Village Blvd.
Mountain Village, CO 81435
(970) 729-2654

TO: Mountain Village Town Council
FROM: Paul Wisor, Town Manager
DATE: April 13, 2022
RE: Work Session Regarding Proposed Development of Meadows Lot 644

Executive Summary: In December 2021, the Town issued an RFP for qualified developers to develop Lot 644 in the Meadows. The RFP Committee recommended Town Council engage Triumph West to undertake the proposed development. Triumph West will be providing conceptual renderings of the proposed development for Town Council's review and comment.

Overview

In December 2021, the Town issued an RFP for qualified developers to develop Lot 644 in the Meadows. The RFP Committee, which consisted of members of Town Council, Meadows residents, and Town staff, reviewed the proposals, interviewed 3 firms, and ultimately recommended Town Council engage Triumph West to undertake the proposed development of Lot 644.

The work session is intended to provide Town Council as a whole the opportunity to learn more about Triumph West, review the proposed project, and provide feedback directly to Triumph West on the current proposal. The proposal to be discussed can be found at [Exhibit A](#), attached hereto.

Triumph West conducted a public open house on the proposed project on March 31st at which it received feedback from the public and incorporated many of the comments into the current design. Triumph West will also present the proposed design to the Meadows Resident Advisory Board on April 20th and get their feedback as well. After the Council work session, Triumph will conduct a work session with DRB on May 5th.

Assuming Council approves a pre-development agreement with Triumph West, Triumph West will begin pursuing an application for development of Lot 644, with the expectation that Council and DRB will hold public hearings on the application later this summer.



AGENDA ITEM #10
TOWN MANAGER
455 Mountain Village Blvd.
Mountain Village, CO 81435
(970) 729-2654

TO: Mountain Village Town Council
FROM: Paul Wisor, Town Manager; David McConaughy, Town Attorney
DATE: April 13, 2022
RE: Pre-Development Agreement with Triumph West for Development of Lot 644

Executive Summary: In December 2021, the Town issued an RFP for qualified developers to develop Lot 644 in the Meadows. The RFP Committee recommended Town Council engage Triumph West to undertake the proposed development. Council is being asked to consider a Pre-Development Agreement, which agreement would authorize Triumph West to pursue approvals to develop deed restricted housing on Lot 644. The Pre-Development Agreement also sets for the terms that will be contained in a Development Agreement that will be executed by the Town and Triumph West in the event the application to develop Lot 644 is approved.

Overview

In December 2021, the Town issued an RFP for qualified developers to develop deed restricted housing on Lot 644 in the Meadows. The RFP Committee, which consisted of members of Town Council, Meadows residents, and Town staff, reviewed the proposals, interviewed 3 firms, and ultimately recommended Town Council engage Triumph West to undertake the proposed development of Lot 644.

In addition to presenting a proposal for development of Lot 644 to the RFP Committee, Triumph West has presented the proposal at a March 31st open house as well as an April 20th meeting of the Meadows Resident Advisory Board. Town Council will similarly participate in a work session with Triumph West regarding the development of Lot 644 at its April 21st meeting.

Assuming Town Council supports the proposed development, staff is requesting Town Council consider approval of a Pre-Development Agreement.

Pre-Development Agreement

The Pre-Development Agreement, attached hereto as **Exhibit A**, authorizes Triumph West to provide pre-development services to the Town, which will enable Triumph West to pursue the necessary approvals to develop Lot 644 on behalf of the Town.

In addition to pre-development services, the Pre-Development Agreement sets forth certain terms to be included in a Development Agreement that will be executed by the Town and Triumph West in the event Triumph West's application for development of Lot 644 is approved by Town Council.

As currently drafted, the Pre-Development Agreement contemplates that upon entitlement, Triumph will present the Town with a budget for the construction of the project. Triumph will be paid a development fee of four percent of the project cost, and Triumph will be solely

responsible for paying the cost of any budget overruns. The Town will contribute \$4.3 million in equity to the project to help Triumph fund upfront construction costs. Upon completion of construction, Triumph and the Town will jointly form an LLC through which the individual units constructed on Lot 644 will be sold pursuant to a deed restriction. The Town and Triumph will split all proceeds equally on a dollar for dollar basis until the Town recoups its equity investment. All additional profit will be split 80/20 between Triumph and the Town. Barring a dramatic shift in the regional housing market, it is quite likely the Town will recoup its investment, and if the Town realizes any profit it will allocate those funds towards other housing efforts.

Proposed Motion

“I move the approve the Pre-Development Agreement between the Town and Triumph West for the proposed development of deed restricted housing on Lot 644 in substantially the form set forth in Exhibit A to the Pre-Development Agreement staff report.”

Exhibit A

PRE-DEVELOPMENT AGREEMENT

THIS PRE-DEVELOPMENT AGREEMENT (the "Agreement") is made this ___ day of April, 2022 (the "Effective Date"), by and between the Town of Mountain Village, a Colorado home rule municipality, with an address of 455 Mountain Village Blvd. - Site A, Mountain Village, Colorado 81485 (the "Town"), and Triumph Development West, LLC, a Delaware limited liability company with an address of 105 Edwards Village Blvd. - #C201, Edwards, Colorado, 81632 ("Developer") (each individually a "Party" and collectively the "Parties").

WHEREAS, the Town is the owner of certain real property more particularly described as Lot 644 Telluride Mountain Village Filing 22 (the "Property");

WHEREAS, the Town wishes to redevelop the Property for deed restricted, resident-occupied housing for employees (the "Project");

WHEREAS, Developer is willing to redevelop the Property for affordable housing; and

WHEREAS, the Parties wish to establish terms of the preliminary services to be provided by Developer for the Project.

NOW, THEREFORE, for and in consideration of the mutual promises and covenants contained herein, the sufficiency of which is mutually acknowledged, the Parties agree as follows:

1. Purpose. The purpose of this Agreement is to set forth the services to be provided by Developer prior to execution of the development agreement for the Project.
2. Scope of Services. During the term of this Agreement, Developer shall perform the following services:
 - a. Developer shall conduct all due diligence necessary to determine whether the Property is suitable for the Project.
 - b. Developer shall prepare a development plan, budget and sales projection for review, feedback and refinement by the Town.
 - c. Developer shall prepare and submit to the Town a development application for the Project for Design Review Board approval.
 - d. Developer shall work with the Town to establish the financing necessary for construction of the Project.
 - e. The Parties acknowledge that the Scope of Services contemplated by this Agreement will require Developer to contract with third-party designers, engineers, consultants and contractors to perform some of the services set forth in the Scope of

Services. The Developer shall prepare a Predevelopment Budget for Town approval, and the Town shall be responsible for these out-of-pocket development costs.

3. Development Agreement Terms. The Project shall be subject to a mutually acceptable development agreement ("DA"), which shall contain the following essential terms, at a minimum:

a. The construction of the Project shall be subject to the Mountain Village Municipal Code and other applicable law.

b. The Project shall be subject to approval by the Town through its typical land use approval process, which the parties acknowledge is not guaranteed, and shall include approximately 33 residential dwelling units including both townhomes and condominiums, the location and design of which will be agreed upon by the Town and Triumph. The project will be approved by the Town through its typical land use approval process.

c. All residential dwelling units on the Property shall be subject to a deed restriction to be approved by Town Council.

d. The Town shall grant to Developer, for the benefit of the Property, easements that are mutually determined to be necessary for the Development, including without limitation utility, drainage, and access easements.

e. The Town shall be responsible for all planning fees, permit fees, impact fees tap fees, or density transfer fees in connection with the Project.

f. The Town will be responsible for constructing site access and infrastructure to the property. This shall include construction of any public improvements such as streets, sidewalks and utilities on access Tract F22-2.

g. Developer shall select the general contractor and modular manufacturer for the Project, with the Town's approval, which shall not be unreasonably withheld.

h. Developer shall procure and include the Town as an additional insured on a policies of insurance that (1) are sufficient to cover construction defects for the term of the applicable statute of limitations and statute of repose, (2) a builder's risk policy to cover full replacement cost in the event of a loss, (3) normal and customary professional liability insurance from the design team.

i. Developer shall maintain all books and records related to the Project for public inspection. Upon request by the Town, Developer shall provide evidence of all costs, expenses and mark-ups related to the Project.

j. Other than the cost of the improvements identified in paragraph 2.f, the Project's development budget shall cover all development costs necessary for the Project.

k. Developer or its general contractor shall provide each homeowner a warranty for the residential dwelling units, for a minimum of one year.

l. Developer shall be entitled to a development fee of 4% of total development costs in connection with its development of the Property to cover all developer overhead and personnel costs. Direct out of pocket costs related to the project such as out of town meals and travel will be included as a separate line item in the budget.

m. Upon receipt of planning entitlement for the development, the Town will contribute the Property to a Development LLC and become a member of the LLC. Triumph will be the managing member of this LLC with the obligation to complete the development.

n. Simultaneously with the closing of the construction loan, the Town or the Mountain Village Housing Authority shall contribute approximately \$4.3 million in equity to the Development LLC for a project that includes approximately 33 units.

o. Triumph will procure and guarantee a construction loan from a lender to finance the balance of construction costs and will provide any excess equity required for the Development.

p. Upon completion and sale of the units, net proceeds from the sale of units would flow in the following priority: (1) repay the construction loan, (2) repay Triumph and Town equity on a pari passu basis, and (3) split any excess proceeds with 80% to Triumph and 20% to the Town. These distributions will be subject to a mutually determined reserve to cover any warranty costs that fall to the Development LLC.

4. Term and Termination.

a. This Agreement shall commence on the Effective Date and shall continue until terminated as provided herein.

b. Either Party may terminate this Agreement upon 30 days advance written notice. In the event of Termination by the Town, the Town shall pay Developer for all out-of-pocket costs and a pro-rata portion of the Triumph fee incurred prior to the date of termination. If, however, Developer has substantially or materially breached this Agreement, the Town shall have any remedy or right of set-off available at law and equity.

5. Professional Responsibility.

a. Developer hereby warrants that it is qualified to assume the responsibilities and render the services described herein and has all requisite corporate authority and professional licenses in good standing, required by law.

b. The work performed by Developer shall be in accordance with generally accepted professional practices and the level of competency presently maintained by other practicing professional firms in the same or similar type of work in the applicable community. The work and services to be performed by Developer hereunder shall be done in compliance with applicable laws, ordinances, rules and regulations.

6. Ownership. Any materials, items, and work specified in the Scope of Services, and any and all related documentation and materials provided or developed by Developer or its consultants shall be owned by the Developer unless these costs are reimbursed by the Town in event of termination by the Town.

7. Insurance.

a. Developer agrees to procure and maintain, at its own cost, a policy or policies of insurance sufficient to insure against all liability, claims, demands, and other obligations assumed by Developer pursuant to this Agreement. At a minimum, Developer shall procure and maintain, and shall cause any subcontractor to procure and maintain, the insurance coverages listed below, with forms and insurers acceptable to the Town.

i. Worker's Compensation insurance as required by law.

ii. Commercial General Liability insurance with coverage at least equal to the limitations on judgment provided by the Colorado Governmental Immunity Act (§ 24-10-114, C.R.S.) at any given time, which for 2022 are currently \$424,000 for one person in a single occurrence or \$1,195,000 for two or more persons in a single occurrence. The policy shall be applicable to all premises and operations, and shall include coverage for bodily injury, broad form property damage, personal injury (including coverage for contractual and employee acts), blanket contractual, products, and completed operations. The policy shall contain a severability of interests provision, and shall include the Town and the Town's officers, employees, and contractors as additional insureds. No additional insured endorsement shall contain any exclusion for bodily injury or property damage arising from completed operations.

c. Such insurance shall be in addition to any other insurance requirements imposed by law. The coverages afforded under the policies shall not be canceled, terminated or materially changed without at least 30 days prior written notice to the Town. In the case of any claims-made policy, the necessary retroactive dates and extended reporting periods shall be procured to maintain such continuous coverage. Any insurance carried by the Town, its officers, its employees, or its contractors shall be excess and not contributory insurance to that provided by Developer. Developer shall be solely responsible for any deductible losses under any policy.

d. Upon request, Developer shall provide to the Town a certificate of insurance as evidence that the required policies are in full force and effect.

8. Miscellaneous.

a. Modification. This Agreement may only be modified by subsequent written agreement of the Parties.

b. Integration. This Agreement and any attached exhibits constitute the entire agreement between Developer and the Town, superseding all prior oral or written communications.

c. Binding Effect. This Agreement shall be binding upon and inure to the benefit of the parties hereto and their respective heirs, successors and assigns.

d. Severability. If any provision of this Agreement is determined to be void by a court of competent jurisdiction, such determination shall not affect any other provision hereof, and all of the other provisions shall remain in full force and effect.

e. Governing Law and Venue. This Agreement shall be governed by the laws of the State of Colorado, and any legal action concerning the provisions hereof shall be brought in San Miguel County, Colorado.

f. TABOR. The Parties understand and acknowledge that the Town is subject to Article X, § 20 of the Colorado Constitution ("TABOR"). The Parties do not intend to violate the terms and requirements of TABOR by the execution of this Agreement. It is understood and agreed that this Agreement does not create a multi-fiscal year direct or indirect debt or obligation within the meaning of TABOR and, therefore, notwithstanding anything in this Agreement to the contrary, all payment obligations of the Town are expressly dependent and conditioned upon the continuing availability of funds beyond the term of the Town's current fiscal period ending upon the next succeeding December 31. Financial obligations of the Town payable after the current fiscal year are contingent upon funds for that purpose being appropriated, budgeted, and otherwise made available in accordance with the rules, regulations, and resolutions of Town of Mountain Village, and other applicable law. Upon the failure to appropriate such funds, this Agreement shall be terminated.

g. Assignment. There shall be no transfer or assignment of any of the rights or obligations of Developer under this Agreement without the prior written approval of the Town.

h. Third Parties. There are no intended third-party beneficiaries to this Agreement.

i. No Joint Venture. Notwithstanding any provision hereof, the Town shall never be a joint venture in any private entity or activity which participates in this Agreement, and the Town shall never be liable or responsible for any debt or obligation of any participant in this Agreement.

j. Independent Contractor. Developer is an independent contractor. Notwithstanding any other provision of this Agreement, all personnel assigned by Developer to perform work under the terms of this Agreement shall be, and remain at all times, employees or agents of Developer for all purposes. Developer shall make no representation that it is a Town employee for any purposes.

k. Notice. Any notice under this Agreement shall be in writing, and shall be deemed sufficient when directly presented or sent pre-paid, first class United States Mail to the Party at the address set forth on the first page of this Agreement.

WHEREFORE, the Parties have executed this Agreement as of the Effective Date.

TOWN OF MOUNTAIN VILLAGE

Laila Benitez, Mayor

ATTEST:

Susan Johnston, Town Clerk

STATE OF COLORADO)
) ss.
COUNTY OF _____)

The foregoing instrument was subscribed, sworn to, and acknowledged before me this _____ day of _____, 2022, by _____ as the Mayor of Mountain Village.

My commission expires:
(S E A L)
Notary Public

DEVELOPER

By: _____
Name: _____
Its: _____

STATE OF COLORADO)
) ss.
COUNTY OF _____)

The foregoing instrument was subscribed, sworn to, and acknowledged before me this _____ day of _____, 2022, by _____ as the _____ of Triumph.

My commission expires:
(S E A L)

Notary Public



AGENDA ITEM #11
TOWN MANAGER
455 Mountain Village Blvd.
Mountain Village, CO 81435
(970) 729-2654

TO: Mountain Village Town Council

FROM: Paul Wisor, Town Manager; Jim Loebe, Transit & Recreation Director; Finn KJome, Public Works Director; Chris Broady, Chief of Police; David McConaughy, Town Attorney

DATE: April 13, 2022

RE: Proposed Agreement for Parking Lot Use with Telluride Regional Airport

Executive Summary: The Town lacks parking during certain months of the year. While the Town identifies and pursues long-term solutions to this issue, staff has negotiated a tentative agreement with the Telluride Regional Airport by which the Town may use TRA land to address some of the Town's parking needs. Staff is requesting Council's input on the main points of such an agreement.

Overview

The Town lacks parking during certain months of the year. In the winter, the Meadows parking lot is consistently overparked as there are not enough spaces to accommodate Big Billies, other Meadows residences, and skier parking. In the summer, the Gondola Parking Garage cannot accommodate the number of RVs that attempt to park in the GPG, nor can the GPG always accommodate the parking needs of many of the local and regional festivals. It is also anticipated the Town will not be able to fully accommodate the parking needs of two major hotel projects to be developed in the future, assuming such projects are approved.

The Telluride Regional Airport currently owns land just south of the runway that can be accessed from a service road that itself can be accessed from Last Dollar Road. The land is currently unimproved but with some work could accommodate 100-200 vehicles.

Town staff has met with TRA staff as well as the TRA board. Subject to the conditions set forth below, both TRA staff and the TRA board are generally amenable to the Town utilizing the TRA land for up to three years for the purpose of addressing some of the Town's parking needs.

Parking Agreement Framework

A draft lease, attached hereto as **Exhibit A**, would permit the Town to begin utilizing the TRA land for parking this spring. The substantive provisions of the lease are as follows:

- No camping permitted (TRA will permit sprinter vans to park there for festivals)
- RV storage only (owners cannot remain in the RV overnight)
- The Town must patrol lot twice a day
- The Town is solely responsible for charging for parking
- The Town must identify system for transporting individuals to and from the lot

- The Town is solely responsible for cost and construction of roadway and parking lot improvements
- The Town must install all necessary signage
- Within six months of execution, Mountain Village must demonstrate it is taking substantive steps towards expansion of Gondola Parking Garage.

Financial Considerations

Town staff and TRA have negotiated a monthly lease of \$7,500 per month. As noted above, the Town is also responsible for the cost of all construction costs associated with the creation of the parking lot. The Town estimates construction of the lot will cost approximately \$75,000. The Town will charge for parking, and the Town intends to enter into parking agreements with Mountain Village businesses for their use of the lot. It is anticipated the Town will be able to cover some, but likely not all, of these costs, through day parking charges and parking agreements.

Nex Steps

The TRA board is reviewing the lease agreement. Town staff will take Council comments, meet with TRA staff, and staff will provide a revised agreement to Council at its May meeting for consideration and approval.

Exhibit A

LEASE AGREEMENT

This LEASE AGREEMENT (“Lease”) is entered into this ___ day of April, 2022, by and between TOWN OF MOUNTAIN VILLAGE, COLORADO, a Colorado home rule municipality (the “Town”) and TELLURIDE REGIONAL AIRPORT AUTHORITY, owner of the public Telluride Regional Airport in San Miguel County, Colorado (the “TRAA”) (collectively the “Parties”).

RECITALS

WHEREAS, the Parties have the power to enter into this Lease pursuant to C.R.S. § 29-1-203, and the Town’s Home Rule Charter and the TRAA’s Bylaws, respectively; and

WHEREAS, the TRAA is the owner of certain real property known as the Telluride Regional Airport, located at 1500 Last Dollar Rd., Telluride, Colorado (the “Property”); and

WHEREAS, the Town is in need of a space for overflow parking for Town employees and construction workers expected to work on various Town projects starting summer 2022; and

WHEREAS, the Town and the TRAA have verbally agreed to allow the Town to construct a parking lot on the Property; and

WHEREAS, the Parties desire to formalize their verbal agreement by entering into this Lease in accordance with the terms and conditions hereof.

AGREEMENT

NOW, WHEREFORE, in consideration of the mutual covenants and promises hereinafter set forth, the Parties agree as follows:

- 1. Recitals.** The foregoing recitals are incorporated herein by reference.
- 2. Lease of Property.** Pursuant to the terms and conditions hereof, the TRAA hereby leases part of the Property depicted on Exhibit A to the Town, and the Town hereby accepts and leases the Property from the TRAA in its as-is condition with all faults.
- 3. Rent.** Rent is seven thousand five hundred dollars (\$7,500.00) per month, which shall be due and payable in full on the first (1st) day of each month. Rent shall be prorated in accordance with the start and end dates of the Term, if applicable.
- 4. Lease Term.** The term of this Lease shall begin on May 1, 2022 and continue until December 31, 2022 (the “Term”), unless sooner terminated as provided herein. The Parties shall have two (2) options to renew this Lease for additional one (1) year terms beginning on January 1, 2023, for a total of three additional (3) years. The Parties shall review the status of the Lease in November of each year. The Lease shall renew automatically, unless either party informs the other in writing of its intent to terminate the Lease at least thirty (30) days before the end of the Term. This Lease, and all of its terms and conditions, shall remain in effect for the duration of any renewal term.
- 5. Use and Improvement of Property.** The Town intends to improve the access road on the Property and lay down gravel on raw land located south of the runway to create a parking lot as depicted in

Exhibit A (the “Parking Lot”) for use as overflow parking by Town employees and construction workers expected to work on various Town projects starting summer 2022 (the “Use”). All costs incurred to construct, improve and maintain the Parking Lot shall be borne solely by the Town.

- 6. Town Management and Use Restrictions.** The Town shall be responsible for management of the Parking Lot including, but not limited to, identifying a system for transporting individuals allowed to use the Parking Lot to and from the lot and charging such individuals for parking, if applicable. The Town shall install and maintain all necessary signage on the Property related to and for Use of the Parking Lot. No camping of any kind shall be permitted on the Parking Lot, except for Sprinter vans and like vehicles during festivals. Motorized and non-motorized recreational vehicles (“RVs”) shall be allowed on the Parking Lot for storage purposes only. The Town shall patrol the Parking Lot twice per day to ensure the Use is in conformity with this Lease. The Town’s duties apply only to maintenance of the Parking Lot and not to the Property generally.
- 7. Insurance.** The Town shall maintain insurance in amounts that meet or exceed the current judgment limitation amounts set forth in the Colorado Governmental Immunity Act, C.R.S. § 24-10-114, to cover losses occurring on the Parking Lot such as property damage, personal injury or death. All such insurance policies shall name the TRAA as an additional insured.
- 8. Gondola Parking Garage Expansion.** Within six (6) months of execution of this Lease, the Town shall demonstrate that it is taking substantive steps toward expanding the Gondola Parking Garage.
- 9. Quiet Enjoyment.** The TRAA agrees that the Town shall peaceably and quietly hold, enjoy and occupy the Property for the Use and the Term herein without any hindrance, interruption, ejection or molestation by the TRAA or by any other persons whatsoever; provided, however, nothing herein shall limit the TRAA’s rights to require compliance with state, federal or local laws or regulations.
- 10. Surrender of Possession.** If, upon expiration or termination of the Term or any renewal term, the TRAA does not grant further use rights to the Town or its assigns, the Town shall peaceably surrender possession of the Property, including the Parking Lot and any improvements thereto made by the Town, to the TRAA.
- 11. Default.** If either party fails to perform in accordance with the terms and conditions of this Lease or is otherwise in breach or default of any of the terms or conditions of this Lease (in any case, a “default”), then the non-defaulting party shall give notice of the default to the other party and that party shall have thirty (30) days thereafter in which to cure such default. If the nature of the default is not curable within such time period and the defaulting party is diligently proceeding in its efforts to cure the breach, the cure period shall be extended for a period not to exceed ninety (90) days, unless otherwise agreed by the non-defaulting party. Notwithstanding any other provision of this paragraph, no cure period shall be allowed for the following matters: any breach of the Town’s insurance obligations under paragraph 7 above; or any default that is not reasonably susceptible of cure. If a default is not cured within the applicable cure period, if any, then the non-defaulting party, at its election and without obligation to do so, may take such action and expend such sums as the non-defaulting party in its ordinary business judgment may deem necessary or appropriate to cure the subject default, in whole or in part, or to protect the interests of the non-defaulting party. All sums, including attorneys’ fees, incurred by the non-defaulting party in connection with the consideration or exercise of this remedy shall be due and payable from the party in default within ten (10) days after demand, from time to time. Any default by a party that is not cured within any applicable cure period established above may be enforced by any or all of the foregoing remedies, and any other

remedies available at law or equity or by statute, and all such rights and remedies shall be cumulative with and non-exclusive of one another, and may be exercised concurrently or successively as the non-defaulting party may elect. No exercise of any one remedy shall constitute or be construed as an election to the bar of any other remedy. In connection with any exercise or pursuit of its remedies under this Agreement, whether or not legal proceedings are actually commenced, the non-defaulting party shall be entitled to recover from the other party any and all attorneys' fees and court costs that the non-defaulting party may incur in connection therewith.

12. General Remedies. In the event that a default occurs under this Lease, the non-defaulting party shall have any and all remedies existing at law and equity, including termination of this Lease, suing for damages resulting from the uncured breach and specific performance. Should the Town's breach remain uncured beyond the cure period set forth in paragraph 11 above, the TRAA shall be entitled, but not limited to, the right of eviction, termination of this Lease, suing for damages resulting from the uncured breach and any other remedy available to the TRAA in law or equity.

13. Notices. All notices required or permitted by this Lease shall be in writing and shall be effective and deemed received at the earliest of: (a) when actually delivered and received, personally, by mail, by messenger services or by fax delivery; (b) seventy-two (72) hours after being postmarked in the United States mail, certified, return receipt requested; (c) on the next business day after deposit for delivery by a nationally recognized overnight courier service such as Federal Express; or (d) on the date sent by e-mail, provided that a delivery receipt for the e-mail (which receipt may be automated), showing the date the e-mail was sent, is given to the sender. All such notices shall be furnished with delivery or postage charges prepaid and addressed to the respective parties as follows:

To the Town: Town Manager
 Town of Mountain Village
 411 Mountain Village Blvd.
 Mountain Village, CO 81435
 pwisor@mtnvillage.org

With a copy to: David H. McConaughy, Esq.
 Garfield & Hecht, P.C.
 901 Grand Ave., Ste. 201
 Glenwood Springs, CO 81601
 dmcconaughey@garfieldhecht.com

To the TRAA: [NAME/TITLE]
 Telluride Regional Airport Authority
 1500 Last Dollar Rd., Ste. 1
 Telluride, CO 81435
 [E-MAIL]

14. Time of the Essence. Time is of the essence hereof.

15. Entire Agreement. This Lease memorializes and constitutes the final, complete, and exclusive agreement and understanding between the Parties. It supersedes and replaces all prior negotiations, proposed agreements and agreements, whether written or oral. The TRAA acknowledge that no official, officer, employee, agent, attorney or other representative of the Town has made any promises or representations whatsoever, express or implied, which is not expressly contained in this

Lease. The TRAA further acknowledges that it has not executed this Lease in reliance upon any representation, or in reliance upon any belief as to any fact not expressly stated in this Lease. This Lease may not be amended or modified, except in writing and signed by the Parties.

- 16. Binding Effect.** This Lease shall be binding upon the Parties hereto, their successors or assigns, and shall not be assigned by anyone without prior written consent of the other respective party hereto.
- 17. No Third-Party Beneficiary.** This Lease is not intended and shall not be construed so as to grant, provide or confer any benefits, rights, privileges, claims, causes of action or remedies to any person or entity as a third-party beneficiary under any statutes, laws, codes, ordinances or otherwise.
- 18. Severability.** In the event any part of this Lease is found to be void, illegal, invalid or unenforceable under present or future laws, then, in such event, the remaining provisions of this Lease shall nevertheless be binding with the same effect as though such part was deleted and shall be construed to effectuate, as nearly as possible, the original intentions of the Parties based upon the entire agreement, including the invalidated provision.
- 19. Captions.** The captions contained in this Lease are for convenience only and shall not affect the construction or interpretation of any provision herein.
- 20. Governing Law, Jurisdiction and Venue.** This Lease is made within the State of Colorado, and the laws of the State of Colorado shall govern its interpretation, validity and enforceability. Personal jurisdiction and venue for any civil action commenced by either party to this Lease, whether arising out of or relating to the Lease, will be deemed to be proper only if such action is commenced in the District Court for San Miguel County, Colorado.
- 21. Attorneys' Fees; Survival.** Notwithstanding anything to the contrary, should this Lease become the subject of litigation to resolve a claim of default in performance, to the extent permitted by law, the prevailing party shall be entitled to reasonable attorneys' fees, expenses and court costs. All rights concerning remedies and/or attorneys shall survive any termination of this Lease.
- 22. Non-Appropriation.** All direct and indirect financial obligations of the Town under this Lease are subject to appropriation, budgeting and availability of funds to discharge such obligations. If the Town's governing body fails to appropriate funds for its obligations under this Lease, then the TRAA may invoke Section 10's right to cure. No provision of this Agreement shall be construed or interpreted: (a) to directly or indirectly obligate the Town or the TRAA to make any payment in any year in excess of amounts appropriated for such year; (b) as creating a debt or multiple fiscal year direct or indirect debt or other financial obligation whatsoever within the meaning of Article X, Section 6 or Article X, Section 20 of the Colorado Constitution or any other constitutional or statutory limitation or provision; or (c) as a donation or grant to or in aid of any person, company or corporation within the meaning of Article XI, Section 2 of the Colorado Constitution.
- 23. Immunity.** The Parties hereto understand and agree that neither the Town nor the TRAA waives or intends to waive by this Lease, or any provision hereof, the monetary limitations and any other rights, immunities and protections provided by the Colorado Governmental Immunity Act, C.R.S. §24-10-101, *et seq.*, as amended from time to time.



AGENDA ITEM #12
TOWN MANAGER
455 Mountain Village Blvd.
Mountain Village, CO 81435
(970) 729-2654

TO: Mountain Village Town Council

FROM: Paul Wisor, Town Manager; Jim Loebe, Transit & Recreation Director; Finn KJome, Public Works Director;

DATE: April 13, 2022

RE: Construction of an Addition to the Gondola Parking Garage

Executive Summary: Town staff has been working with the Parking Committee to address the Town's parking needs. One strategy for addressing parking congestion is the construction of two additional levels of the Gondola Parking Garage. This agenda item is intended to give Council an update on the work done by the Parking Committee.

Update

As demonstrated on several weekends as well as weekdays during the past ski season, the Gondola Parking Garage cannot accommodate current parking demand during certain times of the year. These parking issues have negatively impacted the Mountain Village experience for both residents and guests. Town staff has been working with the Parking Committee to address the Town's parking needs, which includes adding two additional levels to the GPG.

In 2019, engineers from SGM prepared a preliminary Opinion of Probable Costs for a GPG expansion. At that time, SGM estimated the cost of two additional levels would cost approximately \$13,700,000. Given the increase in cost associated with other Town projects, staff estimates the cost of construction is now between \$18,000,000 and \$20,000,000.

With increasing steel prices, increasing price of overall construction, and anticipated delays in other materials and labor, Town staff and the Parking Committee deemed it prudent to get a true sense of scope and costs from SGM. SGM is currently working on design plans for the additional two levels, and SGM will be able to give a more accurate estimate of costs based off these plans. It is anticipated the plans and costs estimates will be provided to the Town in June.

Financing the cost of the construction for the GPG expansion is of significant concern to the Town. In January of 2020, the Town presented TSG with a parking agreement, pursuant to which the Town could charge for parking at GPG. Town staff recommends revisiting this agreement, along with other financing mechanisms, with Town Council and TSG once the Town has more reliable cost estimates.



SAN JUAN RURAL PHILANTHROPY DAYS
RIDGWAY | JUNE 7-9, 2022

January 31, 2022

Town of Mountain Village
Mr. Paul Wisor, Town Manager
455 Mountain Village Blvd
Suite A
Mountain Village, CO 81435

Dear Mr. Paul Wisor:

In 2022, the San Juan region will be presented with a unique and critical opportunity to support our area's nonprofits, local governments, and the communities they serve.

The San Juan Rural Philanthropy Days conference will be held from June 7-9, 2022 in Ridgway and Ouray County. This event will bring together 300 nonprofit, government, and business leaders from Gunnison, Hinsdale, Montrose, Ouray, and San Miguel counties with representatives from major statewide foundations, government, and corporate funding entities.

Rural Philanthropy Days (RPD) is a statewide program supported by the Community Resource Center. Through RPD rural nonprofits obtain direct access to the financial resources, collaborative opportunities, and professional development services they need to accomplish their missions and address community needs. Participating funders learn more about the region's assets, challenges and strategic initiatives to improve the quality of life for residents in rural communities. The conference provides increased access to resources, skill building opportunities, and the cultivation of relationships on a regional scale - and the results are staggering.

Prior to Rural Philanthropy Days, which started in the early 1990s, only 3% of grant funding from the major funders in Colorado made its way outside the Front Range. As of 2019, rural communities are receiving 21% of total funder contributions. For context, the 12 core funders of RPD alone gave more than \$36,000,000 directly to San Juan nonprofits, schools, and governments from 2009 - 2019.

From bringing the nonprofit sector across the region together, increasing awareness of key community needs and making connections - we see new resources invested to build upon the ideas generated and relationships built at the conference. For example, the last time an RPD conference was held in our region was 2017; from 2016 to 2017 funding increased by **48%**.

Nonprofits and local governments have worked tirelessly this past year to provide stability, resources, and aid to our communities. San Juan RPD will provide additional support through training, professional development, networking, presentations and discussions with funders about our region's needs and opportunities. We hope you'll join us in investing in our community through sponsorship of San Juan Rural Philanthropy Days.

Local donors and sponsors are needed to make the RPD conference possible. These sponsors make the conference financially accessible to the small nonprofit organizations, who would benefit most from the conference, by enabling us to keep the registration prices low and accessible.

Early investment by local governments is an important first step for the success of this event. We are grateful for the support of local governments from across the region to this event already coming in and respectfully request the Town of Mountain Village consider being a sponsor for the 2022 San Juan RPD Conference at a \$5,000 level.

By investing in the 2022 San Juan RPD, you invest in the economic health of your community and the region. Nonprofit organizations are a vital part of our communities. They represent a variety of sectors, from education to the arts, healthcare to emergency services. RPD provides opportunities that are otherwise scarce in rural Colorado, including the opportunity to learn about best practices, meet funders, and as a result, become competitive in the world of grants. Join us in helping this event grow and reach new heights.

We will reach out in the next week to follow up regarding next steps and answer any questions. If you have any questions in the interim, feel free to reach out. Our conference Event Coordinator, Melissa McKelvey, can be reached at sanjuanrpd@gmail.com, and Nellie Stagg with Community Resource Center can be reached at 303-623-1540 x170 or stagg@crcamerica.org.

Thank you for your consideration of this request and continued support of our region's nonprofits.

Sincerely,



Carrie Andrew
San Juan RPD Co-Chair
Lone Cone Library
San Miguel County

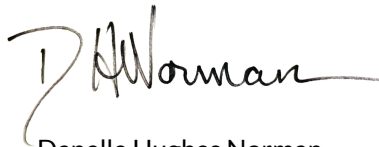

Danelle Hughes Norman
San Juan RPD Co-Chair
Outreach Youth Program
Ouray County

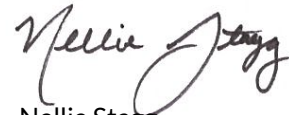

Nellie Stagg
Senior Program Director
Community Resource Center



**HOUSING, PLANNING AND DEVELOPMENT SERVICES
DEPARTMENT**

455 Mountain Village Blvd.
Mountain Village, CO 81435
(970) 728-1392

Agenda Item No. 14a

TO: Town Council
FROM: Michelle Haynes, Housing, Planning and Development Services Director
FOR: Meeting of April 21, 2022
DATE: April 6, 2022
RE: Housing, Planning and Development Services Bi-Annual Report

Our last update to Town Council was on October 21, 2021.

Executive Summary. Planning, Building and Housing activities continue to increase, along with revenues. We expect a similar year in total valuation to last year from 80-100 million. We intend to hire a second building inspector to manage the increase in plan review, projects and inspections. We are interviewing for a planner /community housing coordinator to assist the Housing Director with the administration of the deed restriction qualifications, projects and programs, while being trained for planning plan review. We have a dedicated staff with good relationships in the community that make this department function well. As evidenced in 2021, we had double the valuation in building projects and scant construction complaints, while similarly situated communities were leveling moratoriums. Our department manages not just projects but data and tracking behind the scenes which requires training and expertise (eg revenues, fireplace permits and density). Our department working together, and inter-departmentally, is critical to the success of the Mountain Village as our community builds out.

PLANNING DEPARTMENT

Our department has been focusing on the following items:

- development review
- active building permit projects
- the Comprehensive Plan Amendment Process
- the Meadows Subarea Advisory Board
- two hotel projects
- three community housing projects
- the Community Housing Mitigation Methodology
- Updates to our official zoning map and open space map (in progress)

We are seeing double the volume of single family home design and commercial/hotel development levels not seen since the late 2000's. Design review is being scheduled 6 months out for those items reviewed by the Design Review Board.

In 2022 we have approved 9 homes to date with 4-6 slated each month from April forward. These approvals are valid for 18 months before a building permit must be applied for.

Fee Waivers and Incentive Programs. Below is a report on fees waived within our department.

2021 Waived Fees from January 1, 2021- April 12, 2021 – last year

Fee Waiver or Reduction	Valuation	Fee Waiver or Reduction Value
Deed Restricted Properties	\$30,300.00	\$ 1,620.07
Cedar Shake Roof	\$310,680.50	\$ 12,169.44
Town Projects	\$7,000.00	\$ 597.97
Building Compliance	\$ -	\$ -
Planning Reviews Waived	\$(no valuation)	\$ 1,250.00
Telluride	\$ -	\$ -
TOTAL	\$ 347,980.50	\$ 15,637.48

2022 Waived Fees from January 1, 2022 – April 7, 2022- current year

Fee Waiver or Reduction	Valuation	Fee Waiver or Reduction Value
Deed Restricted Properties	\$ 576,008.00	\$ 4,130.03
Cedar Shake Roof	\$ 1,659,884.30	\$ 58,897.23
Town Projects	\$ 1,466,664.00	\$ 48,330.17
Building Compliance*	\$ 6,213,906.00	\$ 129,850.31
Planning Reviews Waived	\$ -	\$ 3,475.00
Telluride	\$ 182,698.00	\$ 4,881.52
TOTAL	\$ 10,099,160.30	\$ 249,564.26

*In 2011 the Town agreed to waive fees related to a specific building project, we applied that fee waiver to the building permit in 2022.

Participation in all fee waiver programs and projects increased significantly over prior year.

Forest Management and Fire Mitigation – Cedar Shake Rebate Program, Defensible Space Rebate Program, and General Tree Permit Data.

To date, we have processed ten (10) cedar shake building permits as part of the incentive program with a total waived permit value of \$58,897 and valuation of 1.6 million.

60% of the cedar shake program funds have been expended within the first three months of 2022. We respectfully request an increase in cedar shake funding above the \$100,000 allocated for 2022 in order to meet demand for the program. Staff recommends an additional \$50,000 for 2022, with the understanding that TMVOA would also need to approve an increase in funding.

Additionally, in 2021 we saw a total of 17 defensible space projects on private property within the Mountain Village implemented and completed. Due to funding, an additional 7 projects were completed in 2021 but received or will receive their rebates in 2022 – a total of 34 projects total. The Town working with TMVOA (50/50 cost share) provides up to \$10,000 per residence for this work to occur.

As of the time of drafting this memo, we have issued two tree permits for FY 2022 and saw a total of 101 tree permits issued in 2021. This is an increase of approximately 26.25% in the total number of tree permits issued between 2020 and 2021. Most tree permits are issued between May and September, snow depth-dependent. We would anticipate continued interest in individual tree removal permits in the upcoming year.

MCH pheromone packets. MCH pheromone packet distribution will continue this year. MCH pheromone packets are used to protect individual Douglas-fir trees from mortality caused by Douglas-fir bark beetles. The Town of Mountain Village Parks and Recreation Department in

coordination with the Town Forester placed all 200 pheromone packets ordered for the 2021 season with a focus to place these packets along trail corridors and on Mountain Village-owned Open Space. In 2022, 500 MCH packets will be ordered to replace the 200 packets placed in 2021 with the goal of targeting and treating a greater area of Open Space. 50 packets will be set aside for complimentary homeowner use to protect valued Douglas-fir trees on private lots.

Enhanced Communication and Outreach. Public outreach to homeowners about the Town of Mountain Village forestry program has in the past been conducted bi-annually. For 2022, staff anticipates additional outreach and education efforts focused on town residents in the form of Wildfire Forums and/or topic-specific speaker series to help educate homeowners on healthy forests, defensible space best practices, and overall wildfire science. We will continue specific outreach in-house related to the wildfire mitigation program, cedar-shake roof incentives, and the process for hiring contractors and applying for tree removal permits. Outreach will also encourage homeowner involvement through links to the National Fire Protection Association public education site and the national wildfire preparedness day event.

Wood Lot. The woodlot program has been very successful and has helped to reduce greenhouse gas and overall emissions related to the removal of forest products that could otherwise be utilized by regional firewood users. Typically, waste wood from thinning projects would otherwise be transported to the landfill or to private wood yards. Staff anticipates another busy season for Defensible Space projects in 2022 and will continue to allow contractors to utilize the wood lot in order to reduce overall project costs for the residents. Contractor agreements will be updated for 2022 and signage will continue to be provided at the site to help educate and ensure compliance with woodlot regulations. Photographic Remote Monitoring was implemented in 2021 and will continue to take place to ensure woodlot compliance and to determine if further action is necessary.

Town-owned forest health management program. Annual forest health management projects will continue on Town of Mountain Village-owned parcels. Village Court Apartments (Lot 1001) was treated partially in 2021 and is scheduled for additional treatment in Spring 2022. It is the continued goal of staff to accomplish at least one thinning project annually on town-owned properties.

Forest Management Plan. The Town of Mountain Village adopted a Forest Management Plan by Resolution in 2014. We anticipate that during FY22, staff will be reviewing the existing Forest Management Plan and considering whether amendments are needed to be addressed in late 2022. The town is also working to finalize a contract with Dr. Jason Sibold in order to provide forest and climate research specific to the Mountain Village. This work will include monitoring test plots within our existing forest to better understand the long-term transitioning of vegetation types on the landscape. This could help better inform future planning programs along with thinning work to maintain healthy forests that are adapted to future changing climates. This work would tentatively start when the snow melts and continue into 2023, with a report provided to the Town to document the specific information obtained and recommendations for future plans and regulatory documents.

HOUSING DEPARTMENT

Mountain Village Housing Authority

- We have qualified seven owners to purchase deed restricted properties
- We have qualified three renters to occupy deed restricted properties
- We amended the Coyote Court Operating document
- We scanned all SMRHA deed restricted files
- We are revising our applications to be electronic submittals
- We are updating the website to include the following features:

- Electronic applications
- Applications available in Spanish
- Electronic Payment
- Option to list a home for sale or rent

Housing Programs

We are in the midst of adopting the Community Housing Mitigation Methodology

We have not awarded any funds via the YES Program

We have seen an increase in the construction of free market and deed restricted ADU's

One free market ADU in design review associated with a free market single family home

One deed restricted detached condominium received a C of O with an associated ADU.

Community Housing Projects

1. The **VCA Phase IV bid** will close on April 20th. We expect to have a recommendation for Town Council by April 28th.
2. We are working through our public private partnership with Triumph West for Lot **644**
 - a. April 21st, worksession with Town Council
 - b. April 21st, consideration of a pre-development agreement
 - c. May 5, DRB worksession related to design

We anticipate fall entitlements, some initial site prep and spring construction of 2023 with certificate of occupancies by fall of 2023.

3. We received a residential rezone and annexation in the Town of Norwood with our **Spruce Street** property. Next steps - anticipated:
 - a. Conceptual Designs and public hearing sessions in Norwood May-June
 - b. Sketch Plan Review July-August
 - c. Preliminary Plat September-October
 - i. Includes water study
 - ii. Includes a traffic study
 - d. Final Plat October -November

Misc Housing

- Village Court Apartments. A report was provided on February 17, 2022
- We have \$60,000 available in down payment assistance for 2022
- We had one former employees pay back their mortgage assistance loans with the town pursuant to the terms with a total value of approximately \$61,000.

STAFFING

Since last year we have restructured a number of positions within the department and anticipate two new positions yet this year. This is primarily in response to addressing work demands efficiently and challenges with hiring qualified employees.

- Amy Ward was promoted to Senior Planner
- John Miller was realigned to Principal Planner
- The Planning Director assumed Mountain Village Housing Authority duties along with housing project management.
- Connor Reilly, VCA Property Manager, is assisting with MVHA duties such as management of rental leases in Norwood and Prospect Plaza.
- We will hire a second building inspector in 2022.
- We will hire a planner I/housing coordinator in 2022 to assist with housing administration and qualification of purchasers and renters.
- Sam Quinn-Jacobs is our Planning Technician and also manages plaza license agreements and special events in the Village Center.
- Mike Otto, Town Forester, no longer works for the town as of mid-April.

BUILDING DEPARTMENT

Our building inspector, Lars Forsythe has been doing a phenomenal job keeping up with the volume of inspections to date as well as designing the test for the re-certification of all the existing contractors which was required when the Town of Mountain Village adopted the 2018 ICC code cycle. The sheer volume of plan reviews last year and currently has kept Drew in the office and unable to assist Lars with inspections. Due to the continued flow of new homes and larger projects arriving in the near future, we have requested an additional inspector be added to our team (see above). This new inspector will also assist with the planning department DRB inspection when needed. We continue to improve our permitting software, Community Core, by creating sub permits for the planning department approvals. This helps speed up the permit issuance process, data reporting, as well as plan review process by removing the need for back-and-forth emails from Planning and Building.

- We have 438 active building permits, with a majority of these being Mountain Village permits.
- 10 pending building permits to issue with a valuation aggregate of \$16,800,000 to date.
- And 31 active single family home permits in process.
- We expect a multi-family project to break ground in 2022 with a valuation of approximately \$25 million.

Figure 1. Building Permit Valuation Comparison

	2017	2018	2019	2020	2021
Total Building Permit Valuation	\$73,416,195	\$37,504,251	\$53,139,039	\$49,598,171	\$86,759,003
Total Number of Inspections	2,995	2,759	4,203	3,560	4,350
Total Number of Building Permits Issued	575	461	457	435	466

[this area intentionally left blank]

Development Services Activity

Figure 2. Shows the valuation comparison over the past ten years between Mountain Village and Telluride permits that we issue.

Figure 2. Mountain Village Building Permits in Valuation Comparison 2012-2022

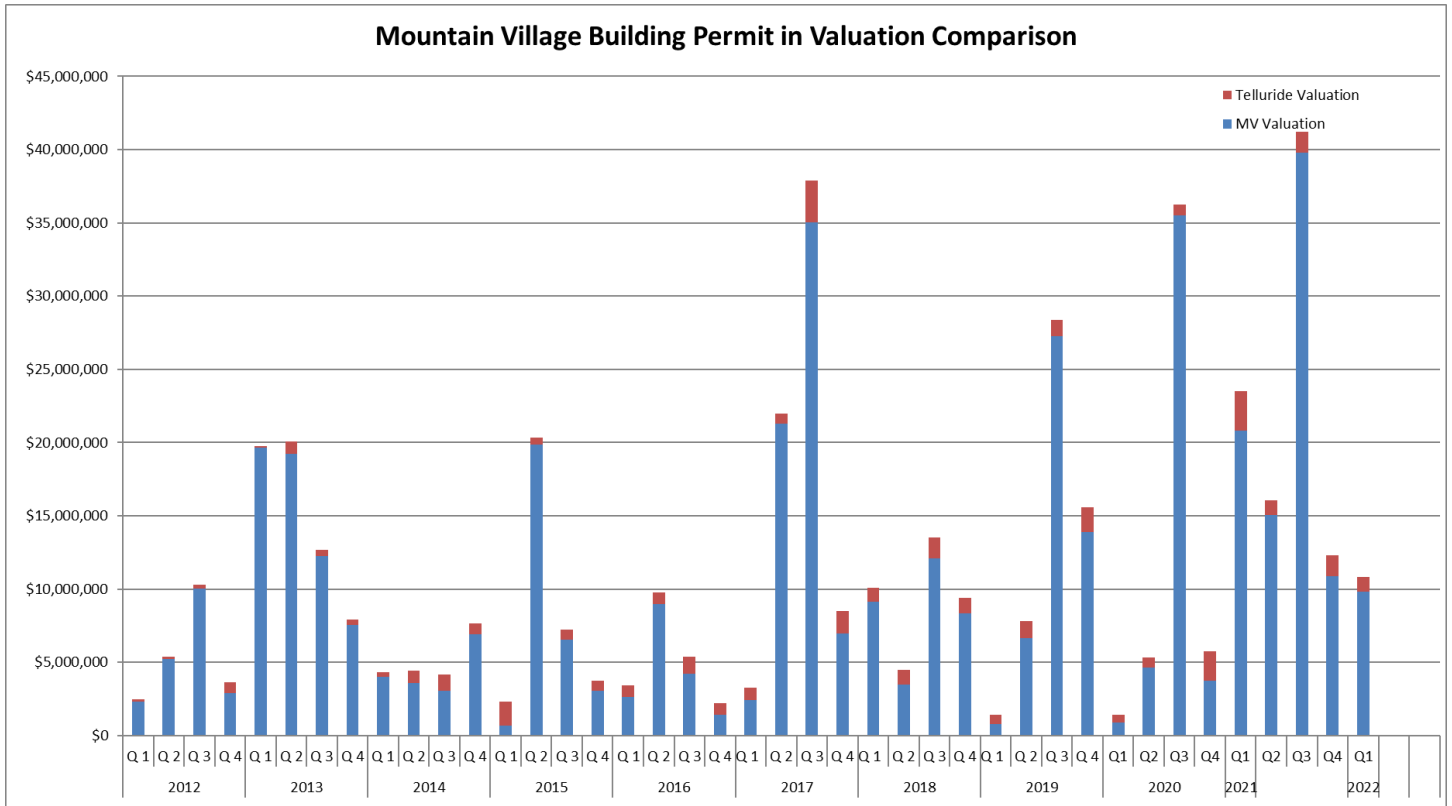
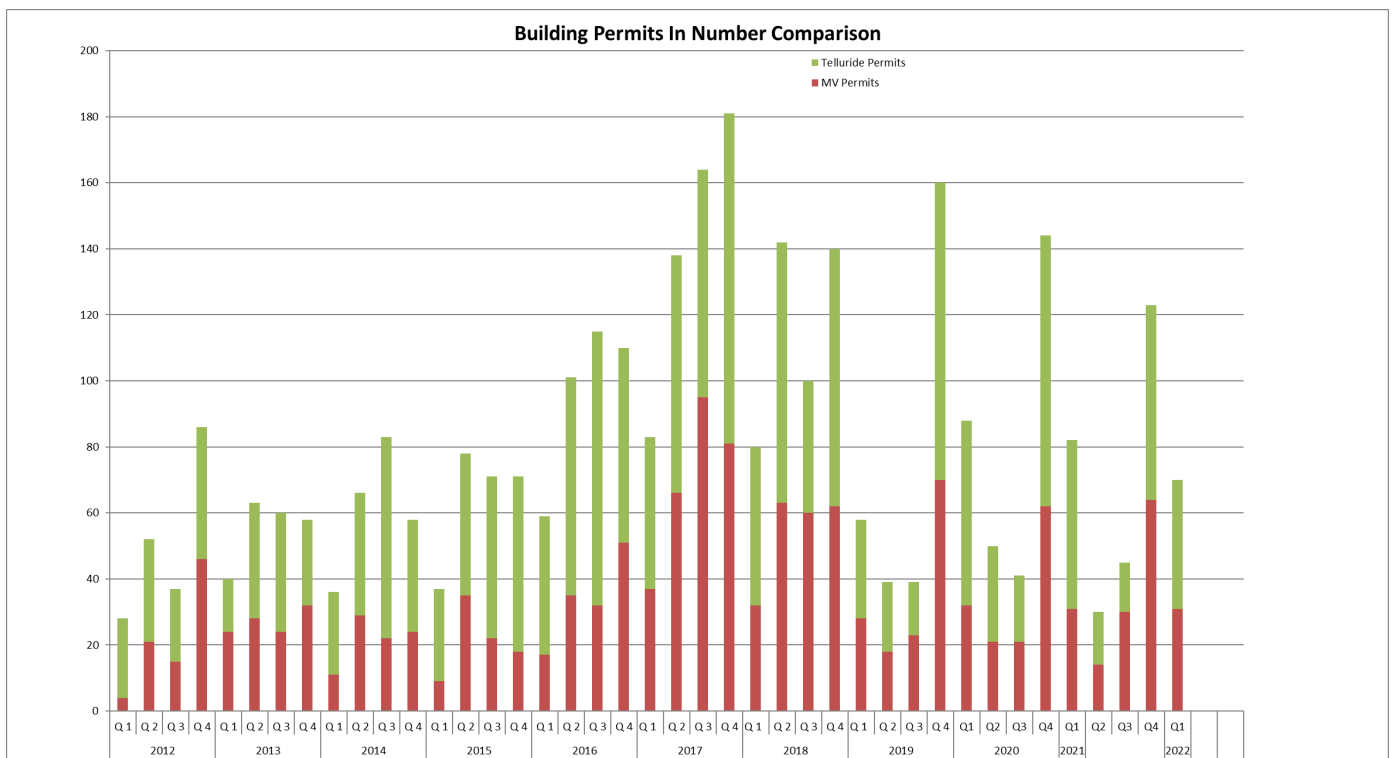
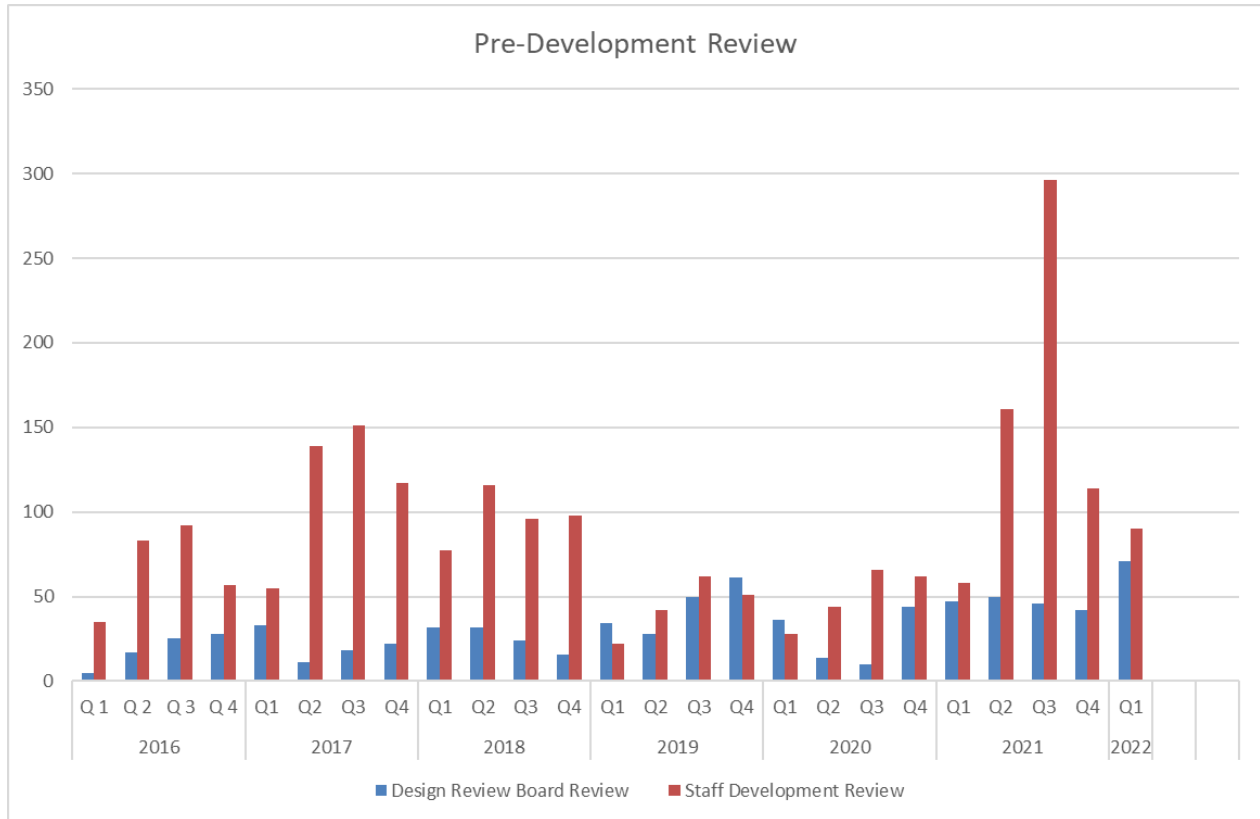

Figure 3. Illustrates the number of building permits issued in total and broken down between Telluride building permits (electrical and plumbing) and those issued for Mountain Village.



Design Review Board agenda items are higher than usual for the first quarter. DRB agendas are full through June right now with our existing base of complete applications, so we are scheduling out 5-6 months for single family development. Figure 4. Shows staff reviews and DRB reviews over a six year period.

Figure 4. Predevelopment Review



CONCLUSION

2021 was the highest building valuation we have seen in recent years. We expect 2022, 2023 and 2024 to be equally high valuation years if our economy, lending and supply chain remain steady due to the constant stream of single family development, a handful of multi-family developments, attainable housing developments and possibly two developments in the Village Center.

Thank you for your continued support of the Planning, Building and Housing Departments.

/mh

Town of Mountain Village Lot 644 Housing Development



4.21.22 Community Meeting

About Triumph Development West

- CO Development Company from Edwards, CO
- Project leads – Mike Foster & Michael O'Connor
- Hospitality & residential development in mountain communities
- History of Public Private Partnerships with municipalities

Example Project: Coburn Crossing – Truckee, CA



Example Project: The Altitude – Glenwood Springs



Example Project: The Eddy – Grand Junction



Example Project: Chamonix Vail



Lot 644 Survey

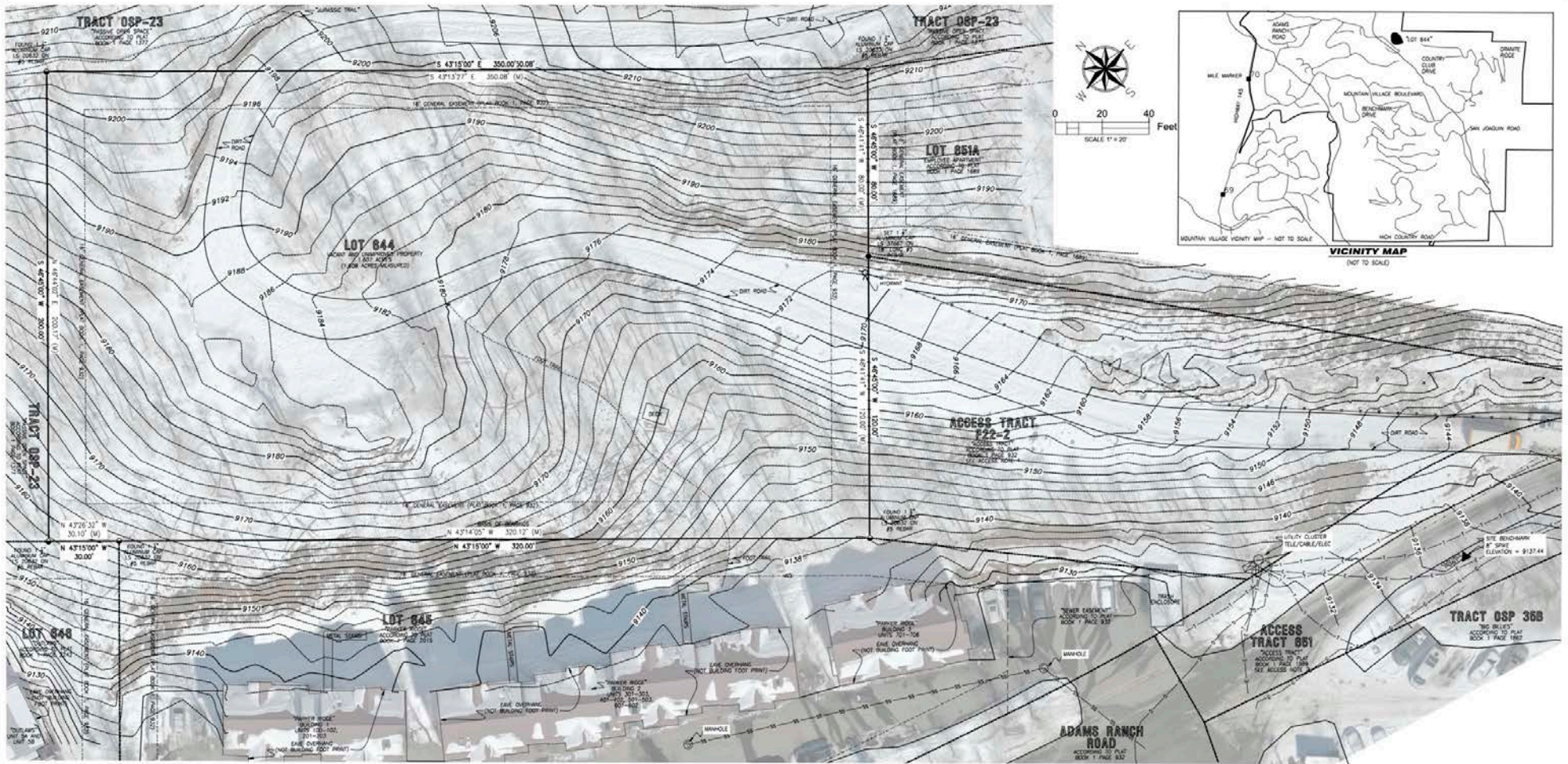

Lot 644 Aerial



Test Fit #1 – All Multifamily Buildings

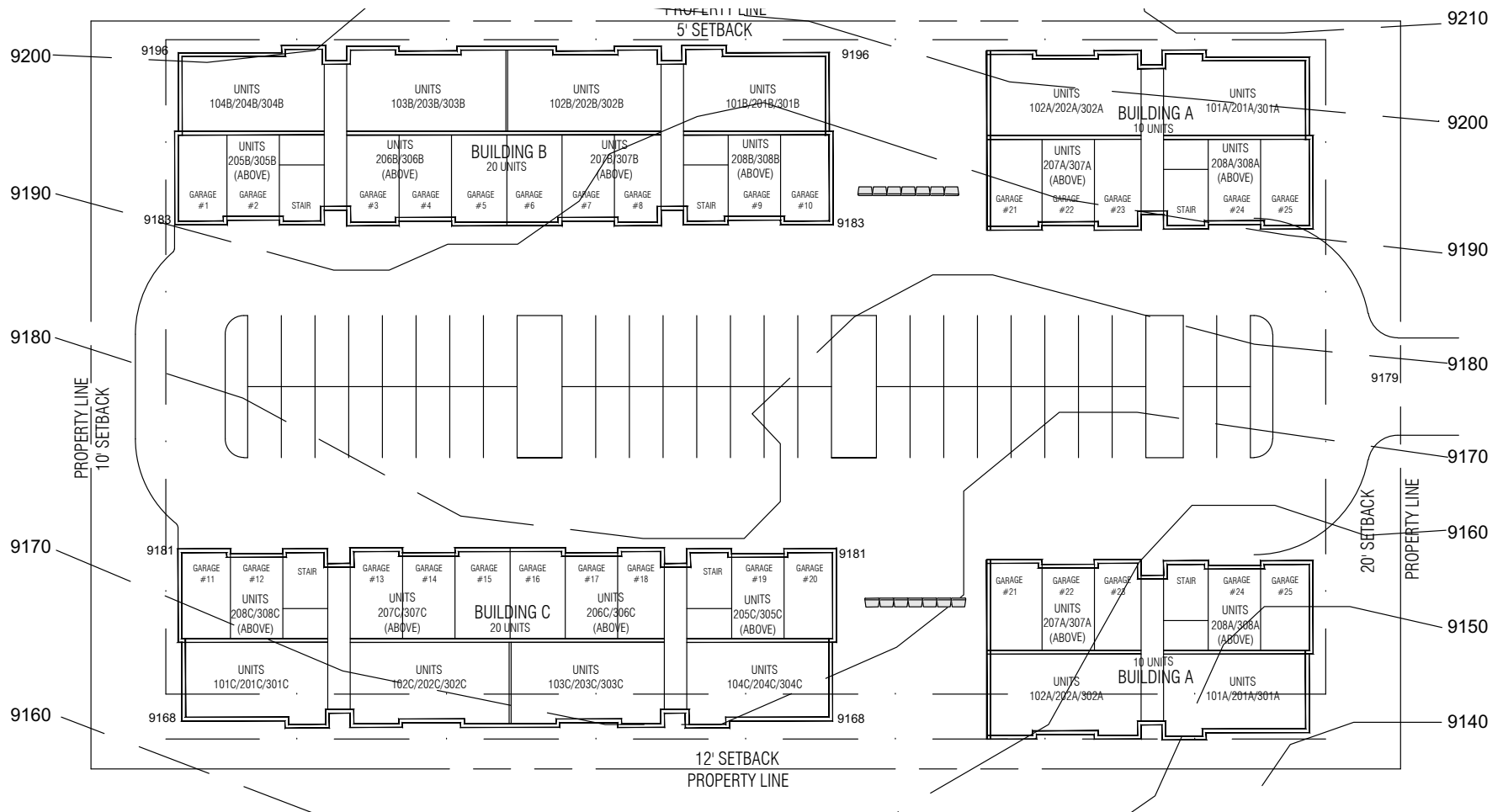

60 Homes:

- 40 Two-Bedroom Apartments
- 20 One-Bedrooms Apartments

82 Parking Spaces:

- 52 Surface Parking
- 30 Garage Parking

Test Fit #2 – Multifamily & Townhomes

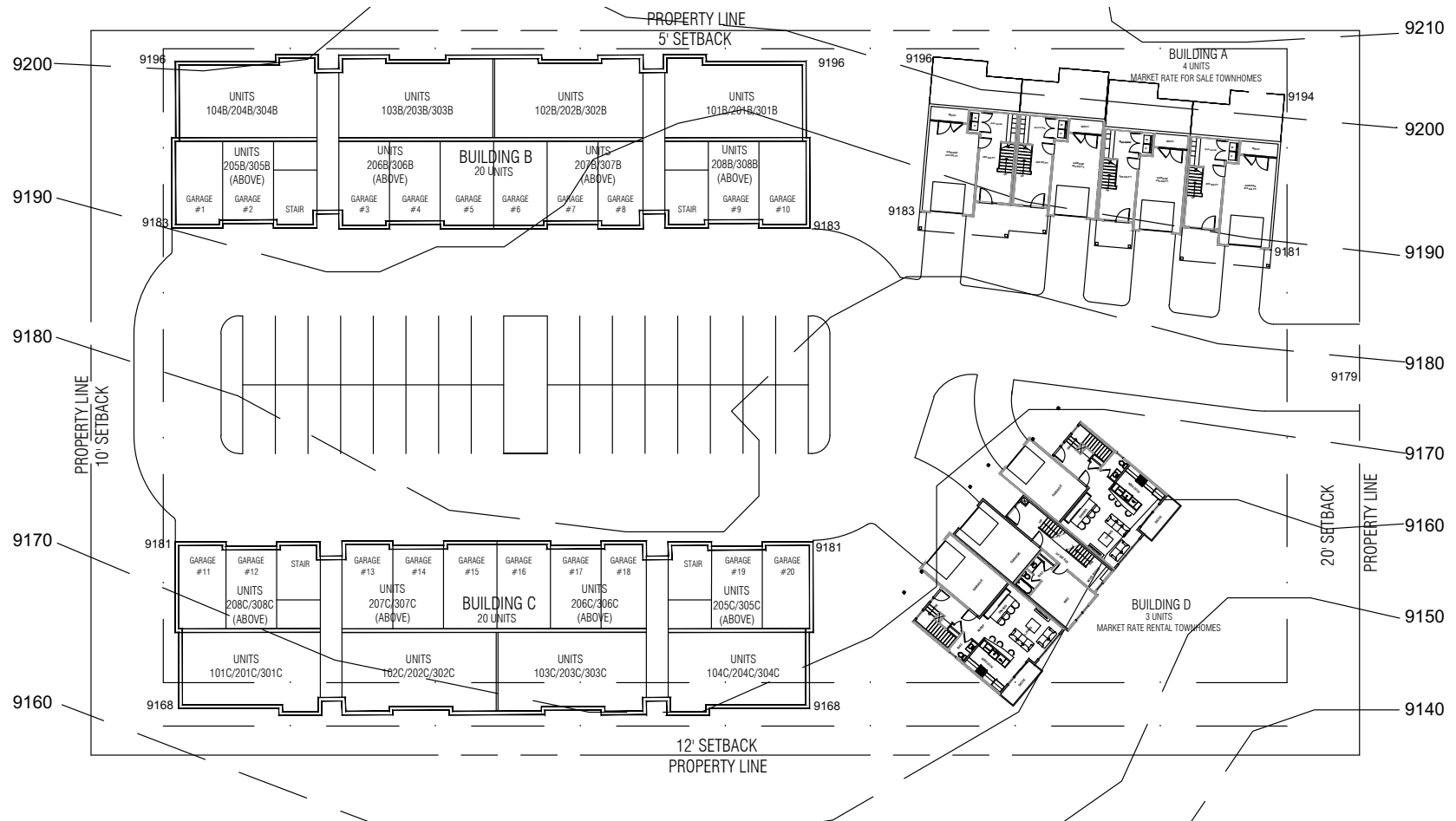

47 Homes:

- 28 Two-Bedroom Apartments
- 12 One-Bedrooms Apartments
- 7 Townhomes

66 Parking Spaces:

- 32 Surface Parking
- 34 Garage Parking

RFP Site Plan – Townhomes & Condos

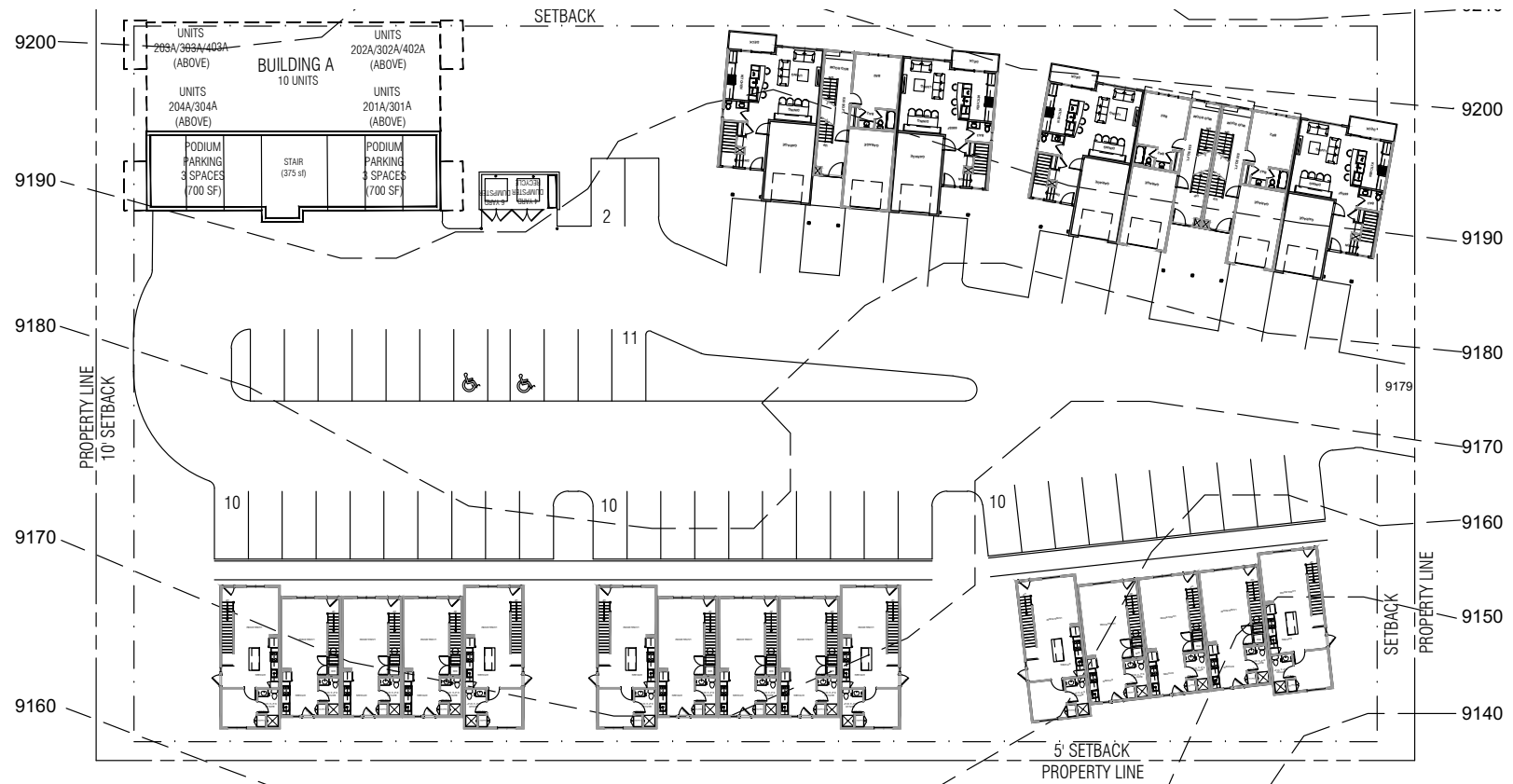

35 Homes:

- 10 One-Bedroom Condos
- 3 Studio Condos
- 22 Townhomes

67 Parking Spaces:

- 54 Surface Parking
- 6 Podium Garage Parking
- 7 TH Garage Parking

Current Site Plan – Townhomes & Condos

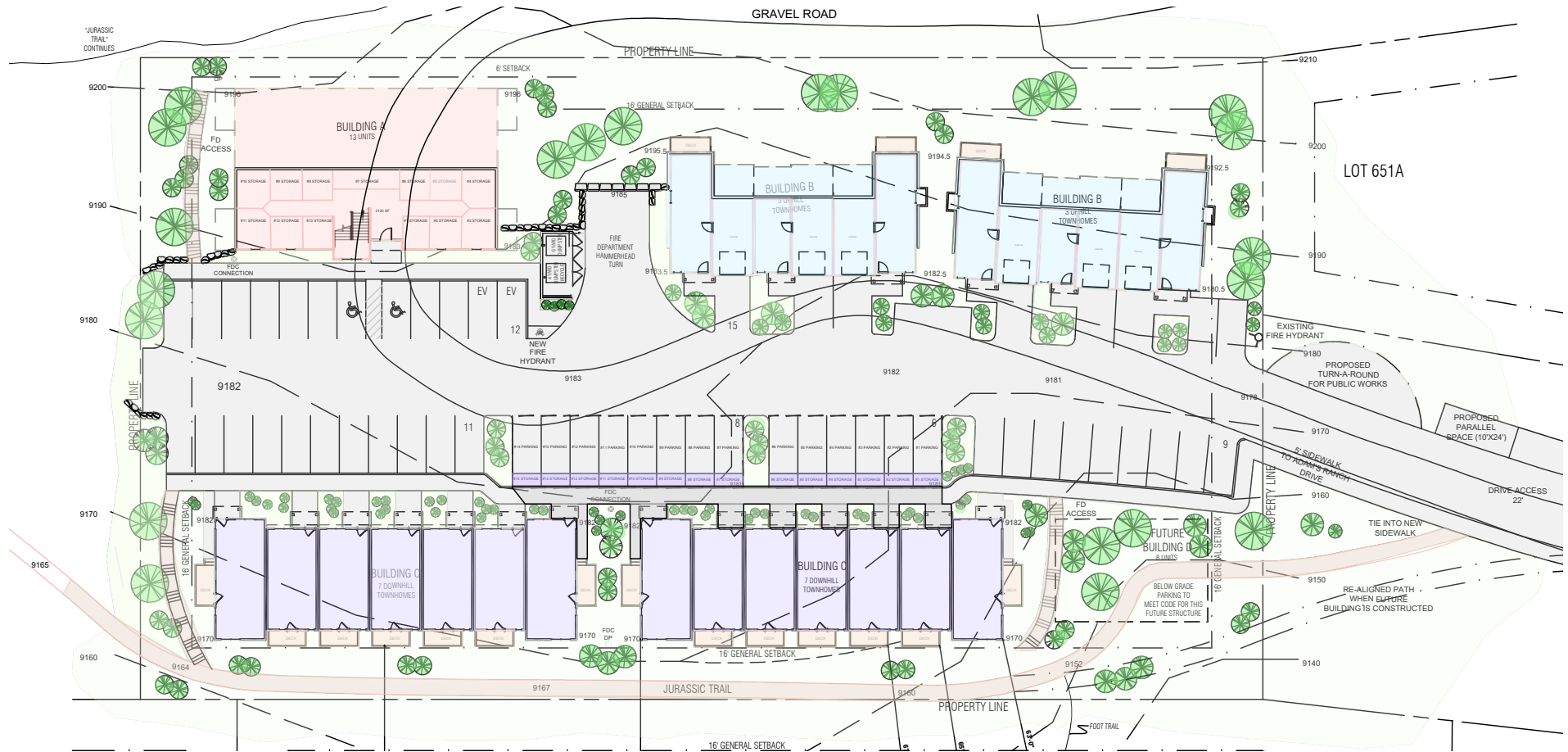

33 Homes:

- 2 Two-Bedroom Condos
- 8 One-Bedroom Condos
- 3 Studio Condos
- 20 Townhomes (2BR and 3BR)

63 Parking Spaces:

- 41 Surface Parking
- 16 Carports with Storage
- 6 TH Garage Parking

Site Section

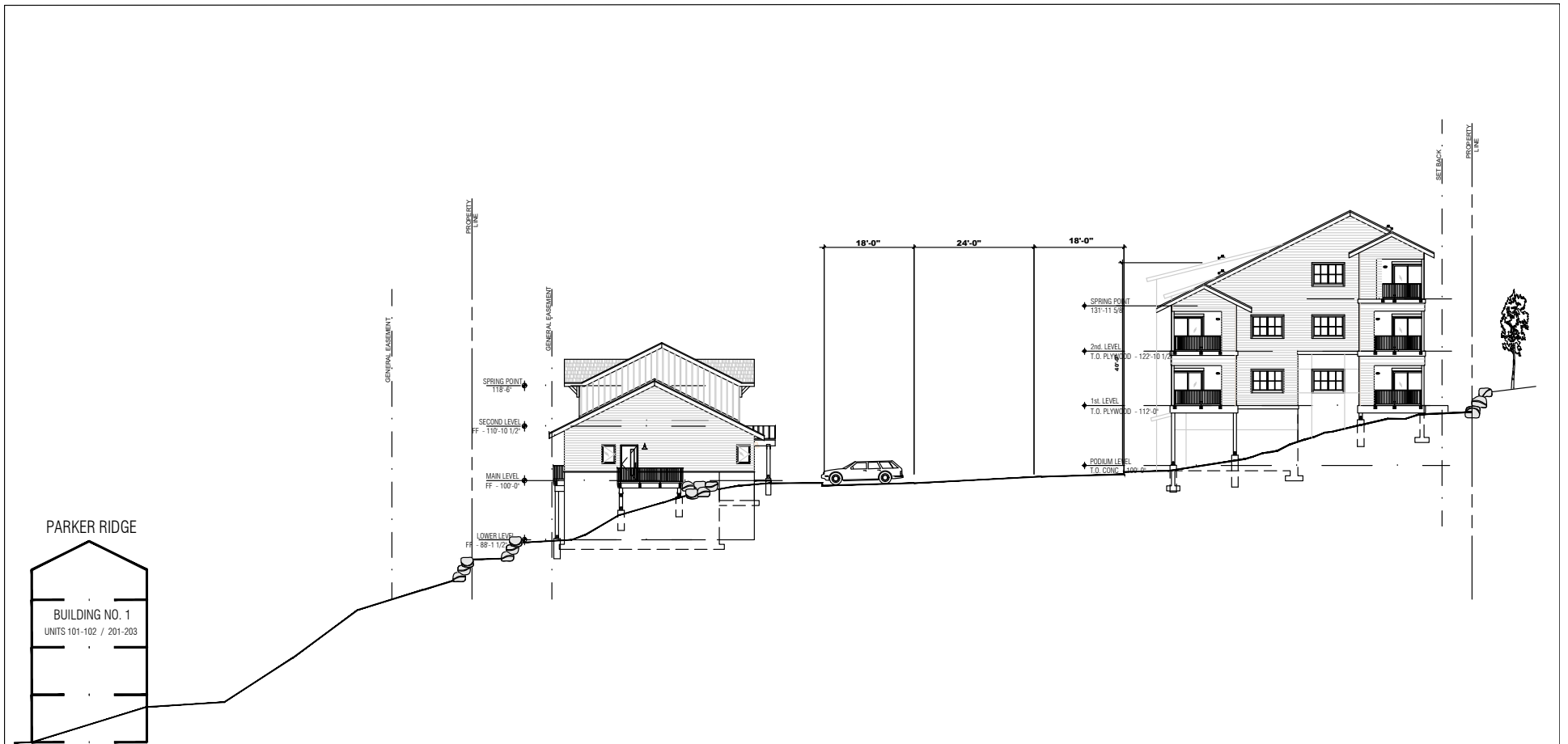

1 SITE SECTION - THROUGH PARKER RIDGE
NTS

MOUNTAIN VILLAGE NEIGHBORHOOD LOT 644 MOUNTAIN VILLAGE, COLORADO	TRIUMPH WEST 105 Edwards Village Blvd #6201 Edwards CO 81632 P.O. Box 2444 www.triumphdev.com	Job No:	Sheet No:
		Drawn By: MEF	A1.1
		Date: 4/11/2022	
		Scale:	



Lot 644 Sample Rendering – From Entrance



Lot 644 Sample Rendering – From the East



SAN JUAN RURAL PHILANTHROPY DAYS

Serving Gunnison, Hinsdale, Montrose, Ouray, and San Miguel counties



Ridgway | June 7-9, 2022



For more than 30 years, CRC has convened rural leaders and statewide grantmakers as partners in the Rural Philanthropy Days (RPD) program. Each year, two regional RPD conferences bring financial, professional development, and network building resources to rural communities. Through your sponsorship of San Juan Rural Philanthropy Days you are supporting nonprofits across the region, as well as each individual and community that benefits from the services of those organizations. Together we strengthen rural Colorado.

Regional Impact of Funding

Funding to the San Juan Region 2016-2019

The last time a Rural Philanthropy Days (RPD) conference was held in the San Juan region was 2017; from 2016 to 2017 funding increased by 48%. The 12 core funders of Rural Philanthropy Days alone gave more than **\$25,000,000** directly to San Juan nonprofits from 2016- 2019

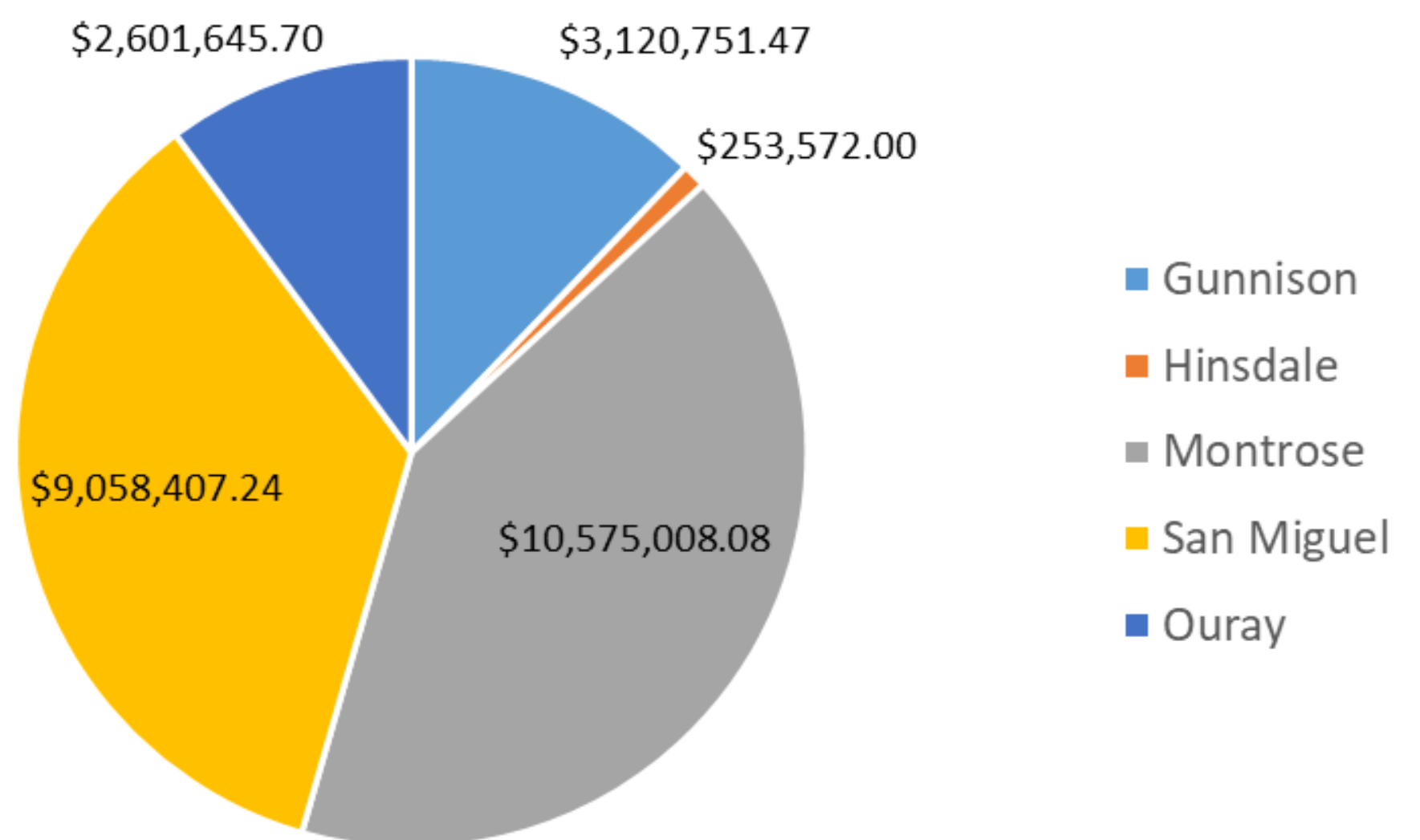

Meet the San Juan RPD Steering Committee

- Carrie Andrew | Lone Cone Library
- Laura Anthon | Lone Cone Library
- Joey Boese | PEER Kindness, Inc.
- Amy Bricker Stahlin | ThinkSharp Consulting
- Victoria Durnan | Ouray County Public Health
- Maryo Ewell | Community Foundation of the Gunnison Valley
- Robyn Funk | Montrose Regional Health
- Sarah B Holbrooke | The Pinhead Institute
- Danelle Hughes Norman | Voyager Youth Program
- Julia Johns | Lake City Arts Council
- Scott Krieger | Community Foundation of the Gunnison Valley
- Chris S Lopez | Colorado Housing Finance Authority

- Carlton Mason | CASA of the 7th Judicial District
- Mel McKelvey | Black Canyon Boys and Girls Club
- Candy A. Meehan | Town of Norwood
- Jennifer Pelligra | Community Options, Inc.
- Amanda Pierce | Town of Norwood
- Patrick Rondinelli | Dept. of Local Affairs
- Lori Sharp | ThinkSharp Consulting
- Deana Sheriff | West End Economic Development Corp.
- Andrea Sokolowski | Home Trust of Ouray County
- Nellie Stagg | Community Resource Center (CRC)
- Ross Valdez | City of Montrose
- Tera Wick | Town of Ridgway

Sponsorship Opportunities

As a sponsor of San Juan RPD, you will connect with over 225 individuals from across the region including staff and board members of local nonprofits, community leaders, local government officials, and statewide grantmaking agencies. A sponsorship of this event demonstrates your organization's civic engagement and commitment to supporting a vibrant nonprofit sector across the San Juan region. If you have any questions you can contact our San Juan RPD Event Coordinator, Melissa McKelvey, at sanjuanrpd@gmail.com.

\$5,000 plus - Premier Level Sponsor

Premium Recognition in Conference Materials, Recognized on Screen at the Conference, Opportunity to Include Materials in Conference Packet, Logo Included on Additional Conference Sponsor Signage, Recognized from Stage at Conference, Logo with Link to Company Page on RPD Website, Feature on Social Media, Opportunity to Customize Sponsor Benefits

\$3,000 - \$4,999 - Platinum Level Sponsor

Recognition in Conference Materials, Recognized on Screen at the Conference, Opportunity to Include Materials in Conference Packet, Logo Included on Additional Conference Sponsor Signage, Recognized from Stage at Conference, Feature on Social Media, Logo with Link to Company Page on RPD Website

\$2,000 - \$2,999 - Gold Level Sponsor

Recognition in Conference Materials, Recognized on Screen at the Conference, Recognized from Stage at Conference, Feature on Social Media, Logo with Link to Company Page on RPD Website

\$1,000 - \$1,999 - Silver Level Sponsor

Recognition in Conference Materials, Listed on Screen at the Conference, Recognized from Stage at Conference, Listed on Social Media, Listed with Link to Company Page on RPD Website

\$250 - \$999 - Bronze Level Sponsor

Recognition in Conference Materials, Listed on Screen at the Conference, Listed on RPD Website